

36"w x 32h Side Hinge

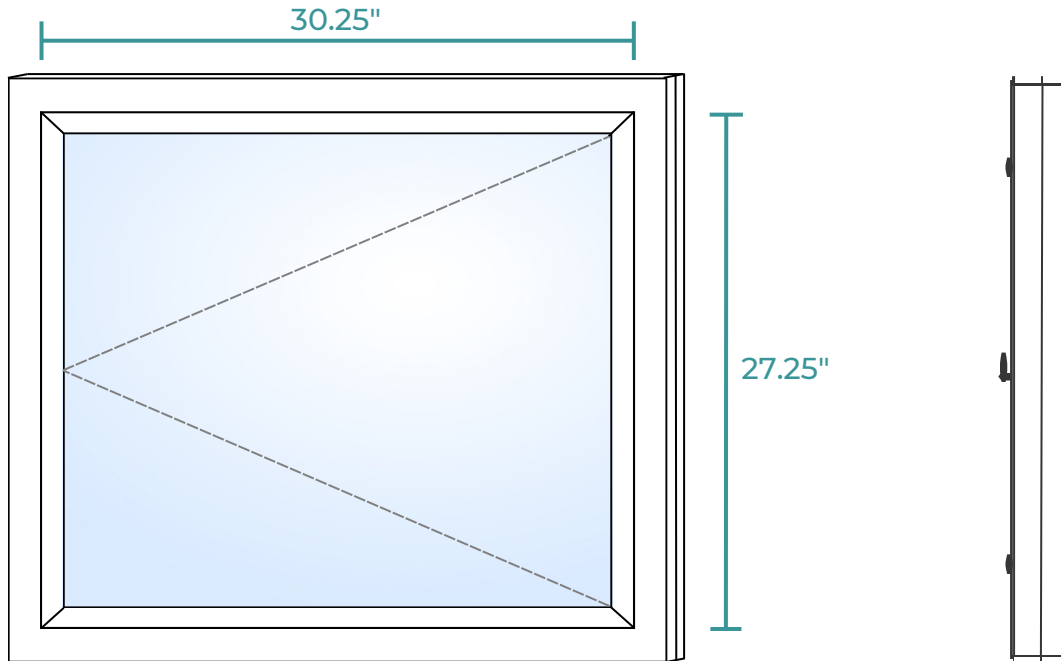

Recommended Rough Opening: 37"w x 33"h



Measurement	Dimension	Area	Frame Thickness
Window Frame	36"w x 32"h		3.25"
Clear Opening	30.25"w x 27.25"h	5.72 Sq. Ft.	
Visible Glass	28.75"w x 24.25"h	4.94 Sq. Ft.	

Component Details

PVC frame and sash with mitre cut welded corners
Aluminum lock and keeper mechanisms
Steel frame and sash hinge brackets
Removable spring-loaded insect screen

Glass Details

Double Pane
Argon Gas Filled
Low-E 272 Coating
U-factor: 0.22*

In-swinging | can be left or right hinged

Testing Details

Forced-entry Resistance
Test (ATSM F588)
F10 Rating

Thermoplastic Corner
Weld Test (Clause 9.3.6.2)
Pass

Air Leakage Resistance Test (ATSM E283)

R class A3 Level
Infiltration = 0.035 cfm/ft² - A3 Level
Exfiltration = 0.036 cfm/ft² - A3 Level

Water Penetration Resistance Test (ATSM E547)

No Leakage or trapped water at 260 Pa
Water Application Rate: 1.492 L/min

*To mitigate against supply chain disruptions, we source glass from multiple suppliers. There may be a slight difference in the U-factor depending on the glass used in each unit.