

INDUSTRIAL HOT WATER PRESSURE  
WASHER  
OPERATOR'S MANUAL

***READ USER MANUAL COMPLETELY  
PRIOR TO USING ALL MACHINERY!!***



CONTENTS

Introduction & Important Safety Instructions..... 2-6  
Component Identification.....7  
Assembly Instructions.....8-11  
Operating Instructions.....11-14  
Detergents and Cleaning Tips.....14  
Shut-Down and Clean Up.....14-15  
Maintenance .....15-16  
Storage.....16-18  
Pump Drawing.....19  
Parts List .....20

Model Number \_\_\_\_\_  
Serial Number \_\_\_\_\_  
Date of Purchase \_\_\_\_\_

The model and serial numbers will be found on a decal attached to the pressure washer. You should record both serial number and date of purchase and keep in a safe place for future reference.

Keep this manual for future references!

**INTRODUCTION & NOTE&IMPORTANT**  
**SAFETYINFORMATION**

Thank you for purchasing this Hot Water Pressure Washer. All information in this manual is based on the latest product information available at the time of printing. We reserves the right to make changes at any time without incurring any obligation.

## **Owner/User Responsibility:**

The owner and/or user must have an understanding of the manufacturer's operating instructions and warnings before using this pressure washer. Warning information should be emphasized and understood. If the operator is not fluent in English, the manufacturer's instructions and warnings should be read to and discussed with the operator in the operator's native language by the Purchaser/owner, making sure that the operator comprehends its contents.

Owner and/or user must study and maintain for future reference the manufacturers' instructions.

**This manual should be considered a permanent part of the machine and should remain with it if machine is resold.**

**When ordering parts, please specify model and serial number.**

## **Note:**

1. Check the amount of oil (gasoline, oil, diesel or kerosene) before starting, check the battery power (if not used for a long time, remove the main line or charge once a month)
2. Wash the debris in the heating tube after the first boot or long time off use (boot without spray gun)
3. Check the high pressure pump inlet frequently (there is a filter, easy to block)
4. When not in use for long time, the gasoline in the gasoline engine should be emptied to prevent the carburetor of the gasoline engine from getting stuck and it is not easy to start the gasoline engine
5. Put in a non-freezing place after use in winter, so as not to affect the next use

## **IMPORTANT SAFETY INSTRUCTIONS**

**WARNING – When using this product basic precautions should always be followed, including the following:**



1. **Read all the instructions before using the product.** Failure to follow instructions could cause malfunction and result in death, serious bodily injury and/or property damage.
2. **To reduce the risk of injury, close supervision is necessary when a product is used near children.**
3. **Know how to stop the machine and bleed pressures quickly. Be thoroughly familiar with the controls.**
4. **Stay alert - watch what you are doing.**

5. **Do not operate the product when fatigued or under the influence of alcohol or drugs.**

6. **Keep operating area clear of all persons**

7. Do not overreach or stand on unstable support. Keep good footing and balance at all times.
8. Follow the maintenance instructions specified in the manual.
9. Use certified battery that specified by the manufacturer: Model U1R7, J-JADE Enterprise, LLC.
10. DO NOT CONNECT TO 120 OR 240 VOLTS AC.
11. DO NOT CONNECT TO POTABLE WATER SUPPLY LINE.

**12.WARNING: Flammable liquids can create fumes which can ignite causing property damage or severe injury.**

**13.Risk of explosion** - do not spray flammable liquids or operate in an explosive location. Operate only where open flame or torch is permitted.

**14.WARNING: Do not place machine near flammable objects during operation or when the engine is hot.**

**15. Minimum clearance from sides and back of unit to combustibile construction: 24 inches (61 cm). Do not use this appliance under overhead combustibile surfaces.**





**WARNING: Keep water spray away from electrical wiring or fatal electric shock may result.**

**WARNING: Spray gun kicks back. Hold with both hands.**

16. Grip cleaning wand securely with both hands before starting the cleaner. Failure to do this could result in injury from a whipping wand.

**WARNING: Risk of fire. Do not add fuel when the machine is operating.**

17. Allow engine to cool for 2 minutes before refueling. If any fuel is spilled, make sure area is dry before testing spark plug or starting the engine. (Fire and/or explosion may occur if this is not done.)

Gasoline engines on mobile or portable equipment shall be refueled:

- a. Outdoors; and
- b. With the engine on the equipment stopped; and
- c. With no source of ignition within 10 feet of the dispensing point; and
- d. Make allowances for expansion of the fuel should the equipment be exposed to a higher ambient temperature.

In an overfilling situation, additional precautions are necessary to ensure that the situation is handled in a safe manner.



**WARNING: Risk of Injection or Severe Injury - Keep Clear of Nozzle - Do Not Touch or Direct Discharge Stream at Persons. - This Product Is To Be Used Only By Trained Operators.**

**CAUTION: Hot discharge fluid. Do not touch or Direct Discharge Stream at Persons.**

8. High pressure developed by these machines can cause personal injury or equipment damage. Use caution when operating.

*i*  
**WARNING: High pressure can cause paint chips or other particles to become airborne and fly at high speeds.**

18. Eye safety devices and foot protection must be worn when using this equipment.

19. Never make adjustments on machine while in operation.

**WARNING: Use only in well ventilated areas. Failure to observe this warning could cause a loss of consciousness or death. This machine was designed for outdoor use only. Use**



**MANUAL high pressure extension hose to clean indoors. Store indoors.**

20. Avoid installing in small areas or near exhaust fans

Exhaust contains poisonous carbon monoxide gas; exposure may cause loss of consciousness and may lead to death. It also contains chemicals known, in certain quantities, to cause cancer, birth defects or other reproductive harm.

21. Do not operate with the spray gun in the off position for more than five minutes as this may cause damage to the pump.

22. The best insurance against an accident is precaution and knowledge of the machine.

23. We will not be liable for any changes made to our standard machines, or any components not purchased from us.

24. Read engine safety instructions provided.

25. Never run pump dry or leave spray gun closed longer than 5 minutes.

26. Inlet water must be cold, clean/fresh. Do not connect to potable water supply line.



**WARNING: Only use recommended fuel. Using other fuels may result in a serious explosion causing personal injury, property damage or loss of life.**

27. CAUTION: CSA certified for use with only No. 1-K kerosene fuel for fuel burner. No. 1 or No. 2 heating oil (ASTM D306) maybe use temporary. **NEVER** use gasoline in your fuel oil tank. Gasoline is more combustible than fuel oil and could result in a serious explosion. **NEVER** use crankcase or waste oil in your burner assembly. Fuel pump malfunction could result from contamination.

28. CAUTION: use only gasoline that specified by the engine.

29. Do not confuse gasoline and fuel oil tanks. Keep proper fuel in proper tank.

30. Protect machine from freezing. NEVER store below 32 degrees without winterizing machine.

31. Be certain all quick coupler fittings are secured before using pressure washer.

32. Do not allow acids, caustic or abrasive fluids to pass through the pump.

33. To reduce the risk of injury, close supervision is necessary when a product is used near children. Do not allow children to operate the pressure washer.

34. Do not operate this product when fatigued or under the influence of alcohol or drugs. Keep operating area clear of all persons.

35. Protect high pressure hose from vehicle traffic and sharp objects.

36. Before disconnecting high pressure hose from water outlet, turn burner off and pull the trigger on the spray gun allowing water to cool to below 100° F before stopping machine. Then open the spray gun to relieve pressure. Failure to properly cool down or maintain the heating coil may result in a steam explosion and/or heating coil damage.

37. Do not overreach or stand on unstable support. Keep good footing and balance at all times.

38. **This machine must be attended during operation.**

39. **IMPORTANT NOTICE:** When using the boiler on the pressure washer be sure to run cold water through the boiler before shutting down the machine

40. **IMPORTANT NOTICE:** Make sure you only use SAE 30 or 40 non-detergent oil in the pump

41. **CAUTION:** *Risk of injury. Disconnect battery ground terminal before servicing.*

42. **CAUTION:** *Moving this machine on a slope causes instability and may result in machines tipping over. Use lifting bar provided on the center top of frame.*

## **COMPONENT IDENTIFICATION**

### **Refer to Appendix**

**Pump** — Develops high pressure.

**Starter Grip** — (Not Shown) Used for starting the engine manually.

**Spray Gun** — Controls the application of water and detergent onto cleaning surface with trigger device. Includes safety latch.

**Detergent Injector** — Allows you to siphon and mix detergents.

**Variable Pressure Control Wand** — Must be connected to the spray gun. This wand handle controls discharge flow from one tube to both wand tubes. When water is discharged from both tubes you will have a pressure loss and allows chemical siphoning when used in combination with a detergent injector.

**High Pressure Hose** — Connect one end to water pump discharge nipple and the other end to spray gun.

**Note:** **If trigger on spray gun is released for more than 2 minutes, water will leak from valve. Warm water will discharge from pump protector onto floor. This system prevents internal pump damage.**

## ASSEMBLY INSTRUCTIONS

### Installation Code:

**U.S.: THE INSTALLATIONS MUST CONFORM WITH LOCAL CODES.**

**CANADA: THE INSTALLATION OF THE EQUIPMENT SHALL BE IN ACCORDANCE WITH THE REGULATION OF AUTHORITIES HAVING JURISDICTION AND CSA STANDARD B139.**

**Contact your electrician, plumber, utility company for specific details**

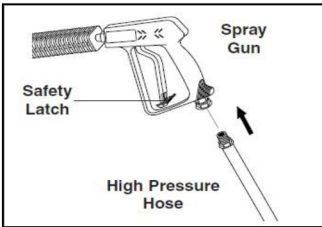

**STEP 1:** Attach the high pressure hose to the spray gun using teflon tape on hose threads.

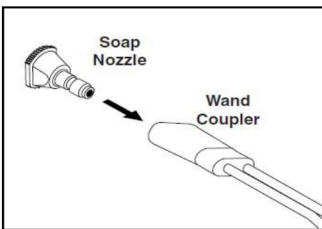

**STEP 2:** Pull the spring-loaded collar of the wand coupler back to insert your choice of pressure nozzle.

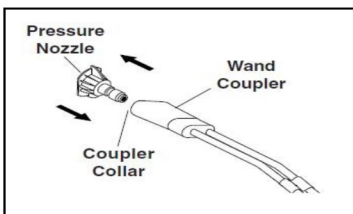

**STEP 3:** Release the coupler collar and push the nozzle until collar clicks. Pull the nozzle to make sure it is seated properly.

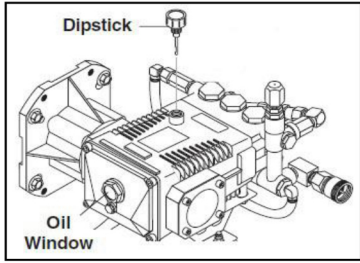

**STEP 4:** Remove shipping cap and install oil dipstick. Check pump oil level by using dipstick or observe oil level in oil window (if equipped). Use 30 wt. non detergent oil.

**STEP 5:** Connect the high pressure hose to the pump discharge fitting. Push coupler collar forward until secure.

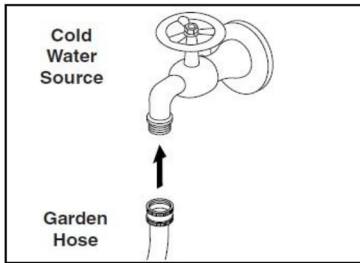

**STEP 6:** Connect garden hose to the cold water source.

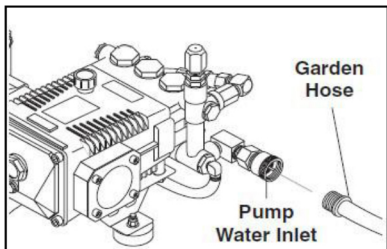

**STEP7:** Connect the garden hose to pump water inlet. Inspect inlets. Do not connect to potable water supply line

## Step 8 Battery Installation

**CAUTION: Use only certified battery that specified by the manufacturer: Model U1R7, J-JADE Enterprise, LLC.**

**The battery must be installed before starting the engine, or else damage may occur to the engine voltage regulator.**

The battery must be installed in the protective battery compartment located under the engine show as below. The dimension of the battery is 19 cm/L \* 12 cm/W \* 20 cm/H.

To install the battery, first remove the back cover to gain access to the battery compartment. Follow the steps below for connecting and disconnect the battery.

The red wires should be connected and fixed to the Positive battery terminal (+)  
The black wires should be connected and fixed to the Negative battery terminal (-)

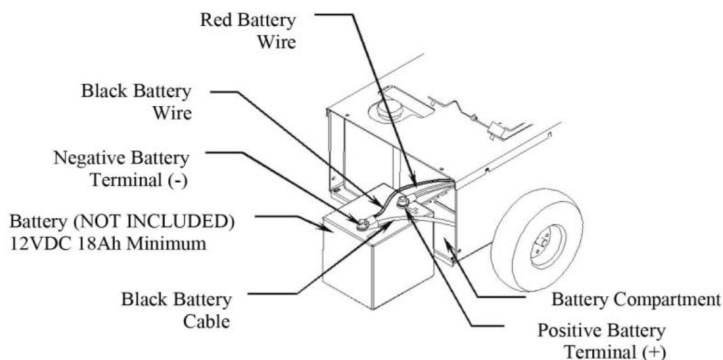

### **⚠️ WARNING: Battery Hazards**

Batteries are hazardous because they contain caustic acid, can emit explosive gases, and can cause electric shock. Caution must be exercised when making connections to a battery to avoid shock and contact with the acid, and to prevent any sparking that could lead to an explosion. ALWAYS follow the general battery safety rules and instructions listed below.

**Warning: Disconnect Battery Pack Before Cleaning or Servicing**

**Warning: Use only the Battery Charger that together with the Battery Pack.**

**CAUTION: Do not run the pump without water or pump damage will result.**

## **OPERATING INSTRUCTIONS**

**Max. Working Pressure: 4,000 PSI**

**Max. 1.77 Gal/h (6.7 L/h)**

**CAUTION: CSA certified for use with only No. 1-K kerosene fuel. Factory**

**Tested: Kerosene, Diesel, Fuel Oil**

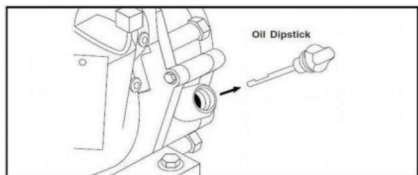

**STEP 1:** Check engine oil level. Oil level should be level with the bottom of the oil filler neck. Be sure the machine is level when checking the oil level.

(Refer to the engine's operating manual included with machine.) We recommend that

the oil be changed after the first 5 hours of use, then once every 50 hours. **Note:** Improper oil levels will cause low oil sensor to shut off engine. **IMPORTANT! Do not run engine with high or low oil levels as this will cause engine damage.**

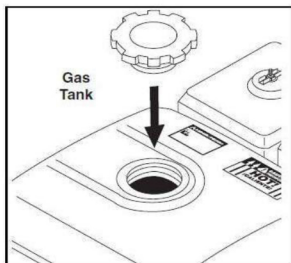

**STEP 2:** Fill gas tank with unleaded gasoline. Do not use leaded gasoline.

**Caution: Read warnings on pg. 4 and engine manual.**

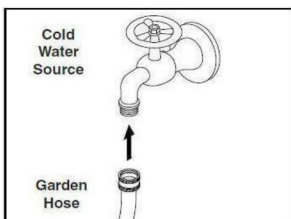

**STEP 3:** Connect garden hose to the cold water source and turn water on completely. Never use hot water.



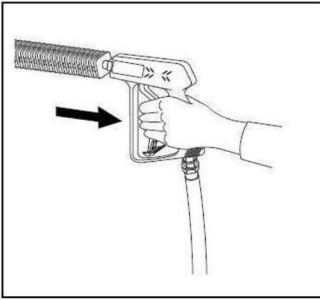

**STEP 4:** Trigger the spray gun to eliminate trapped air then wait for a steady flow of water to emerge from the spray nozzle.

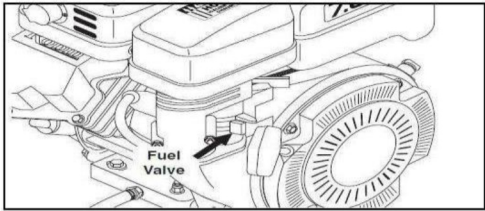

**STEP 5:** Rotate the fuel shut-off valve to the "On" position. Slide the fuel valve lever to the "ON" position. When the engine is not in use, leave the fuel valve in the "OFF" position.

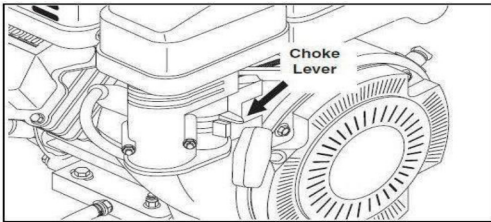

**STEP 6:** Pull the choke lever out to the "Choke" position (on a warm engine, leave the choke lever in, in the run position). Push the choke lever to the

"Closed" position. To restart a warm engine, leave the choke lever in the "Open" position.

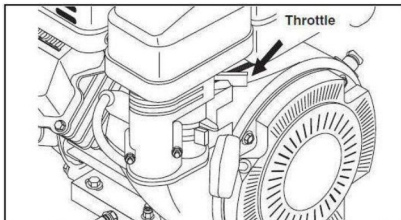

**STEP 7:** Turn the engine to "Run" position.

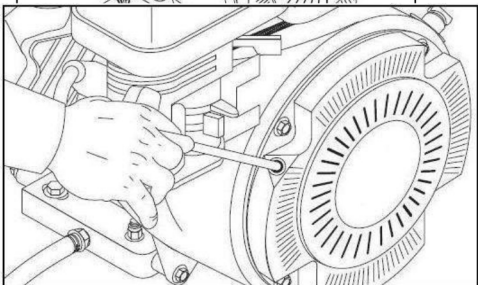

**STEP 8:** Pull the starter grip. If the engine fails to start after 2 pulls, squeeze the trigger gun to release pressure and repeat step. Return starter gently. After the engine warms up enough to run smoothly, move choke to run position and throttle to fast position.



**CAUTION:** Small engines may kick back. Do not hold pull starter grip tightly in hand.



**STEP 8:** Turn on HEAT Switch, Fastening-down temperature On 90°C



**WARNING!** Never replace nozzles without engaging the safety latch on the spray gun trigger.

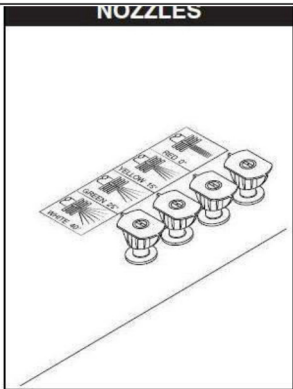
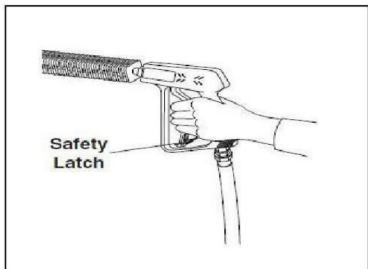

The four color-coded quick connect nozzles provide a wide array of spray widths from 0° to 45° and are easily accessible when placed in the convenient rubber nozzle holder, which is provided on the front of the machine.

**NOTE:** For a more gentle rinse, select the white 40° or green 25° nozzle. To scour the surface, select the yellow 15° or red 0° nozzle. To apply detergent select the black nozzle.

**Recommendations:**

- Before cleaning any surface, an inconspicuous area should be cleaned to test spray pattern and distance for maximum cleaning results.
- If painted surfaces are peeling or chipping, use extreme caution as pressure washer may remove the loose paint from the surface.
- Keep the spray nozzle a safe distance from the surface you plan to clean. High pressure wash a small area, then check the surface for damage. If no damage is found, continue to pressure washing.

**CAUTION - Never use:**

- Bleach, chlorine or other corrosive chemicals
- Liquids containing solvents (i.e., paint thinners, gasoline, oils)
- Tri-sodium phosphate products
- Ammonia products
- Acid-based products

**These chemicals will harm the machine and will damage the surface being cleaned.**



**SHUTTING DOWN AND  
CLEAN-UP**

**STEP 1:** Turn temperature controller on 0

station, turn off HEAT Switch.

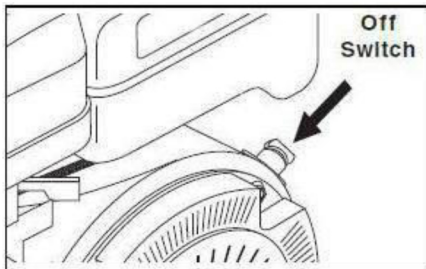

**STEP 2:** Turn off the engine.

When the pressure washer is not being operated or is being stored for more than one month, follow these instructions:

1. Replenish engine oil to upper level.
2. Drain gasoline from fuel tank, fuel line, fuel valve and carburetor.
3. Pour about one teaspoon of engine oil through the spark plug hole, pull the starter grip several times and replace the plug. Then pull the starter grip slowly until you feel increased pressure which indicates the piston is on its compression stroke and leave it in that position. This closes both the intake and exhaust valves to prevent rusting of cylinder.
4. Cover the pressure washer and store in a clean, dry place that is well ventilated away from open flame or sparks. NOTE: The use of a fuel additive, such as STA-BIL®, or an equivalent, will minimize the formulation of fuel deposits during shortage. Such additives may be added to the gasoline in the fuel tank of the engine, or to the gasoline in a storage container.

### **After Extended Storage**



**CAUTION: Prior to restarting, thaw out any possible ice from pressure washer hoses, spray gun or wand.**

During the winter months, rare atmospheric conditions may develop which will cause an icing condition in the carburetor. If this develops, the engine may run rough, lose power and may stall. This temporary condition can be overcome by deflecting some of the hot air from the engine over the carburetor area. NOTE: Refer to the engine manufacturer's manual for service and maintenance of the engine.

## **MAINTENANCE**

### **PREVENTATIVE MAINTENANCE**

1. Check to see that the water pump is properly lubricated.
2. Follow Winterizing Procedures to prevent freeze damage to the pump and coils.
3. Always neutralize and flush detergent from system after use.
4. If water is known to be high in mineral content, use a water softener in your water system or de-scale as needed.
5. Do not allow acidic, caustic or abrasive fluids to be pumped through system.
6. Always use our high grade quality cleaning products.
7. Never run pump dry for extended periods of time.
8. Use clean fuel: kerosene, No. 1 fuel oil or diesel. Replace fuel filter every 100 hours of operation. Avoid water contaminated fuel as it will seize up the fuel pump.
9. If machine is operated with smoking or eye burning exhaust, coils will soot up, not letting water reach maximum operating temperature. (See section on Air Adjustments.)
10. Never allow water to be sprayed on or near engine or burner assembly or any electrical component.

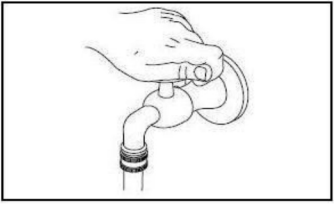

**STEP 3:** Turn off water supply.

pressure.

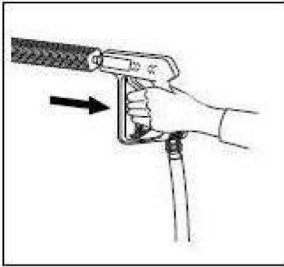

**STEP 4:** Press trigger to release water

**STEP 5:** Disconnect the garden hose from the water inlet on the machine.

**STEP 6:** Disconnect the high pressure hose from high pressure outlet.

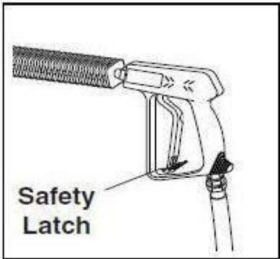

**STEP 7:** Engage the spray gun safety lock.

## **STORAGE**

**CAUTION:** Always store your pressure washer in a location where the temperature will not fall below 32°F (0°C). The pump in this machine is susceptible to permanent damage if frozen. **FREEZE DAMAGE IS NOT COVERED BY WARRANTY.**

1. Stop the pressure washer, squeeze spray gun trigger to release pressure.
2. Detach water supply hose and high pressure hose.
3. Turn on the machine for a few seconds, until remaining water exits. Turn engine off immediately.
4. Drain the gas and oil from the engine.
5. Do not allow high pressure hose to become kinked.
6. Store the machine and accessories in a room which does not reach freezing temperatures.

**CAUTION:** Failure to follow the above directions will result in damage to your pressure washer.

11. Periodically de-lime coils as per instructions.

12. Check to see that engine is properly lubricated. It is advisable, periodically, to visually inspect the burner. Check air inlet to make sure it is not clogged or blocked. Wipe off any oil spills and keep this equipment clean and dry. The areas around the pressure washer should be kept clean and free of combustible materials, gasoline and other flammable vapors and liquids. The flow of combustion and ventilating air to the burner must not be blocked or obstructed in any manner. Consult factory if vent stacking is going to be used.

## MAINTENANCE AND SERVICE

### **Unloader Valves:**

Unloader valves are preset and tested at the factory before shipping. Occasional adjustment of the unloader may be necessary to maintain correct pressure.

### **Winterizing Procedure:**

Damage due to freezing is not covered by warranty. Adhere to the following cold weather procedures whenever the washer must be stored or operated outdoors under freezing conditions.

During winter months, when temperatures drop below 32°F, protecting your machine against freezing is necessary. Store the machine in a heated room. If this is not possible then mix a 50/50 solution of anti-freeze/ water into a 5 gallon bucket. Place a short section of garden hose into the bucket and connect it to the machine. Elevate the bucket and turn the pump on to siphon the anti-freeze through the machine. If compressed air is available, an air fitting can be screwed into the inlet connector and, by injecting compressed air, all water will be blown out of the system.

### **Pumps:**

Use SAE 30W non-detergent oil at winter, using SAE 40W non-detergent oil at summer. Change oil after the first 100 hours of use. Thereafter, change the oil at 100 hour intervals is. Oil level should be checked by using the dipstick found on top of the pump or the red dot visible through the oil gauge window. Oil should be maintained at that level.

### **Fuel:**

Use clean fuel oil that is not contaminated with water and debris. Replace fuel filter and drain tank every 100 hours of operation. Use No. 1 or No. 2 Heating Oil (ASTM D306) only.

**NEVER** use gasoline in your burner tank. Gasoline is more combustible than fuel oil and a serious explosion could result. **NEVER** use crankcase or waste oil in your burner. Fuel unit malfunction could result from contamination.

**Fuel Control System:**

These machines utilize a fuel solenoid valve located on the fuel pump to control the flow of fuel to the combustion chamber. This solenoid valve, which is normally closed, is activated by a flow switch when water is flowing through it. When an operator releases the trigger on the spray gun, the flow of water through the flow switch stops, turning off the current to the fuel solenoid. The solenoid then closes, shutting off the supply of fuel to the combustion chamber. Controlling the flow of fuel in this way allows for an instantaneous burn or no burn situation, thereby eliminating high and low water temperatures, and combustion smoke normally associated with machines incorporating a spray gun.

**CAUTION:** Periodic inspection is recommended to insure that the fuel solenoid valve functions properly. This can be done by operating the machine and checking to see that when the trigger on the spray gun is in the off position, the burner is not firing.

**Electrode Setting:**

(See illustration below.)

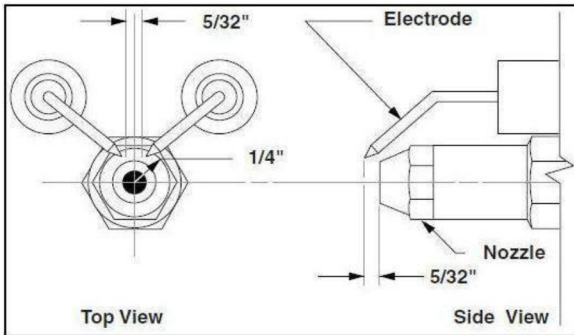

**Periodically check wiring connections. If necessary to adjust electrodes, use diagram.**



# Pump Drawing

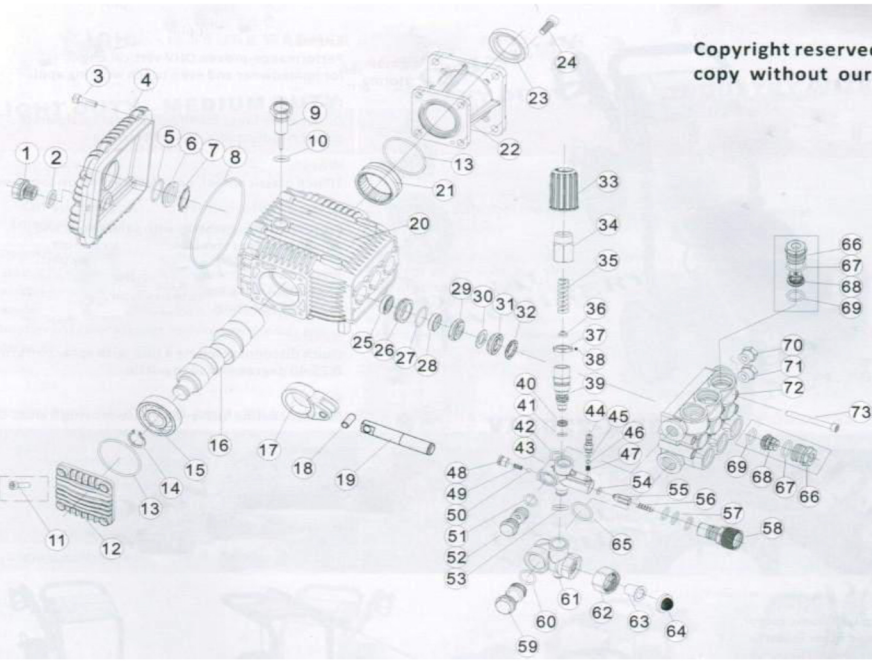

Copyright reserved do not copy without our permit

# Parts List

## PARTS LIST

Ref No.	Description	Ref No.	Description	Ref No.	Description
1	Drain plug	26	Retainer ring	51	O-ring
2	Gasket	27	O-ring	52	Outlet banjo bolt
3	Screw	28	Low pressure seal	53	O-ring
4	Crankcase cover	29	Seal compaction ring	54	O-ring
5	O-ring	30	Seal Compaction flake	55	Checking valve
6	Side glass	31	High-pressure seal	56	Spring
7	Fix clip	32	Supporting ring	57	O-ring
8	O-ring	33	Plastic cap	58	Outlet quick connector
9	Vented oil plug	34	Knob	59	Inlet banjo bolt
10	O-ring	35	Spring	60	O-ring
11	Bolt	36	Spring seat	61	By-pass housing
12	Crankshaft cover	37	Jam nut	62	Swivel nut
13	O-ring	38	Fix screw	63	Inlet connector
14	Snap ring	39	Unloader Valve	64	Inlet water filter
15	Ball bearing	40	Valve Seat	65	O-ring
16	Crankshaft	41	O-ring	66	Valve Plug
17	Connecting rod	42	O-ring	67	O-ring
18	Fix pin	43	Valve housing	68	Checking valve assy
19	Ceramic plunger	44	Soap suction nozzle	69	O-ring
20	Crankcase	45	O-ring	70	Outlet plug
21	Needle bearing	46	Steel ball	71	Inlet plug
22	Flange	47	Spring	72	Bolt
23	Oil seal	48	Valve plug	73	Manifold head
24	Bolt	49	Spring		
25	Oil seal	50	Steel ball		