

Please read through this manual before operation

INSTALLATION AND OPERATION MANUAL



Your safety our standards



RECEIVING

The shipment should be thoroughly inspected as soon as it is received. The signed Bill of Lading is acknowledgement by the shipping carrier as receipt of this product as listed in your invoice as being in a good condition of shipment.

If any of these goods listed on this Bill of Lading are missing or damaged, do not accept goods until the shipping carrier makes a notation on the freight bill of the missing or damaged goods. Do this for your own protection.

Keep this operation manual near the machine at all times. Make sure that **ALL USERS** read this manual.

BE SAFE

Your new lift was designed and built with safety in mind. However, your overall safety can be increased with proper training and thoughtful operation on the part of the operator. **DO NOT** operate or repair this equipment without reading this manual and the important safety instructions shown inside. Keep this operation manual near the lift at all times. Make sure that **ALL USERS** read and understand this manual.

IMPORTANT SAFETY INSTRUCTIONS SAVE THESE INSTRUCTIONS

PLEASE READ THE ENTIRE CONTENTS OF THIS MANUAL PRIOR TO INSTALLATION AND OPERATION. BY PROCEEDING WITH LIFT INSTALLATION AND OPERATION YOU AGREE THAT YOU FULLY UNDERSTAND THE FULL CONTENTS OF THIS MANUAL. FORWARD THIS MANUAL TO ALL OPERATORS. FAILURE TO OPERATE THIS EQUIPMENT AS DIRECTED MAY CAUSE INJURY OR DEATH.



Contents

symbols and printing characters	2
General Information	3
To The Reader	
To The Reader	4-5
Packing/Transport/Storage	6-7
Product Description	8
Technical Specification	9-11
Safety	12-14
Installation	15-19
Operation And Use	20-22
Maintenance	23-24
Troubleshooting	25
Warranty	26
Parts List	



Printing Characters And Symbols

Throughout this manual, the following symbols and printing characters are used to facilitate reading:

	Indicates the operations which need proper care
	Indicates prohibition
	Indicates a possibility of danger for the operators
	Indicates the direction of access for motor vehicles to the lift
BOLD TYPE	Important information

	WARNING: Before operating the lift and carrying out any adjustments, read Chapter 6 "Installation" carefully. All proper operations for a better functioning lift are shown.
--	---



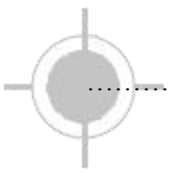

General Information

This chapter contains warning instructions to operate the lift properly and prevent injury to operators or objects. This manual has been written to be used by shop technicians in charge of the lift (operators) and routine maintenance technicians (maintenance operators). The operating instructions are considered to be an integral part of the machine and must remain with it for its whole useful life. Read every section of this manual carefully before operating the lift and unpacking it since it gives helpful information about:

- **safety of people**
- **safety of the lift**
- **safety of lifted vehicles**

The company is not liable for possible problems, damage, accidents, etc. resulting from failure to follow the instructions contained in this manual.

Only skilled technicians of AUTHORISED DEALERS or SERVICE CENTERS AUTHORISED by the manufacturer shall be allowed to carry out lifting, transport, assembling, installation, adjustment, calibration, settings, extraordinary maintenance, repairs, overhauling and dismantling of the lift.

The manufacturer is not responsible for possible damage to people, vehicles or objects if said operations are carried out by unauthorized personnel or the lift is improperly used.

Any use of the machine made by operators who are not familiar with the instructions and procedures contained herein shall be forbidden.

1.1 Manual Keeping

For a proper use of this manual, the following is recommended:

- Keep the manual near the lift, in an easily accessible place.
- Keep the manual in an area protected from dampness.
- Use this manual properly without damaging it.
- Any use of the machine made by operators who are not familiar with the instructions and procedures contained herein shall be forbidden.

This manual is an integral part of the lift: it shall be given to the new owner if and when the lift is resold.



1.2 Obligation In Case Of Malfunction



In case of machine malfunction, follow the instructions contained in the following chapters.

1.3 Cautions For The Safety Of The Operator

Operators must not be under the influence of sedatives, drugs or alcohol when operating the machine.



Before operating the lift, operators must be familiar with the position and function of all controls, as well as with the machine features shown in the chapter "Operation and use"

1.4 Warnings



Unauthorized changes and/or modifications to the machine relieve the manufacturer of any liability for possible damages to objects or people. Do not remove or make inoperative the safety devices, this would cause a violation of safety at work laws and regulations.



Any other use which differs from that provided for by the manufacturer of the machine is strictly forbidden.



The use of non genuine parts may cause damage to people or objects

Declaration Of Warranty And Limitation Of Liability

The manufacturer has paid proper attention to the preparation of this manual. However, nothing contained herein modifies or alters, in any way, the terms and conditions of manufacturer agreement by which this lift was acquired, nor increase, in any way, manufacturer's liability to the customer.

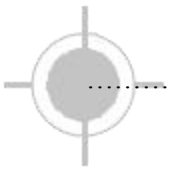

To The Reader

Every effort has been made to ensure that the information contained in this manual is correct, complete and up-to date. The manufacturer is not liable for any mistakes made when drawing up this manual and reserves the right to make any changes due the development of the product, at any time.

Machines may be updated or slightly modified from an aesthetic point of view and, as a consequence, they may present different features from these shown, this without prejudicing what has been described herein.

2.1 Technical Servicing

For all servicing and maintenance operations not specified or shown in these instructions, contact your Dealer where the machine was bought, or the Manufacturer's Commercial Department.
Only skilled personnel who are familiar with the lift and this manual shall be allowed to carry out packing, lifting, handling, transport and unpacking operations



Packing/Transport/Storage



3.1 Packing

The packing of the lift is delivered in following components:

(1) base units packed in a plywood box, including N. 8 rubber pads



(2) portable power unit packed in a plywood box.



The weight of these two packages is 600kg



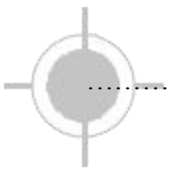

3.2 Lifting And Handling

When loading/unloading or transporting the equipment to the site, be sure to use suitable loading (e.g. cranes, trucks) and hoisting means. Be sure also to hoist and transport the components securely so that they cannot drop, taking into consideration the package's size, weight and center of gravity and its fragile parts.



Hoist and handle only one package at a time

3.3 Storage And Stacking Of Packages

Packages must be stored in a covered place, out of direct sunlight and in low humidity, at a temperature between 14°F and 104°F.

Stacking is not recommended: the package's narrow base, as well as its considerable weight and size make it difficult and hazardous.

3.4 Delivery And Check Of Packages

When the lift is delivered, check for possible damages due to transport and storage; verify that what is specified in the manufacturer's confirmation of order is included. In case of damage in transit, the customer must immediately inform the carrier of the problem.

Packages must be opened paying attention not to cause damage to people (keep a safe distance when opening straps) and parts of the lift (be careful the objects do not drop from the package when opening).



Product Description

Lift Description

The surface mounted lift has been designed for the lifting of motor-vehicles for maintenance. The maximum lifting weight is as specified on the serial plate. All mechanical frames, such as platforms, extensions, base frames and arms have been built in steel plate to make the frame stiff and strong while keeping a low weight

This chapter describes the lift's principal elements, allowing the user to be familiar with the machine. As shown in figure 1, the lift is composed of two:

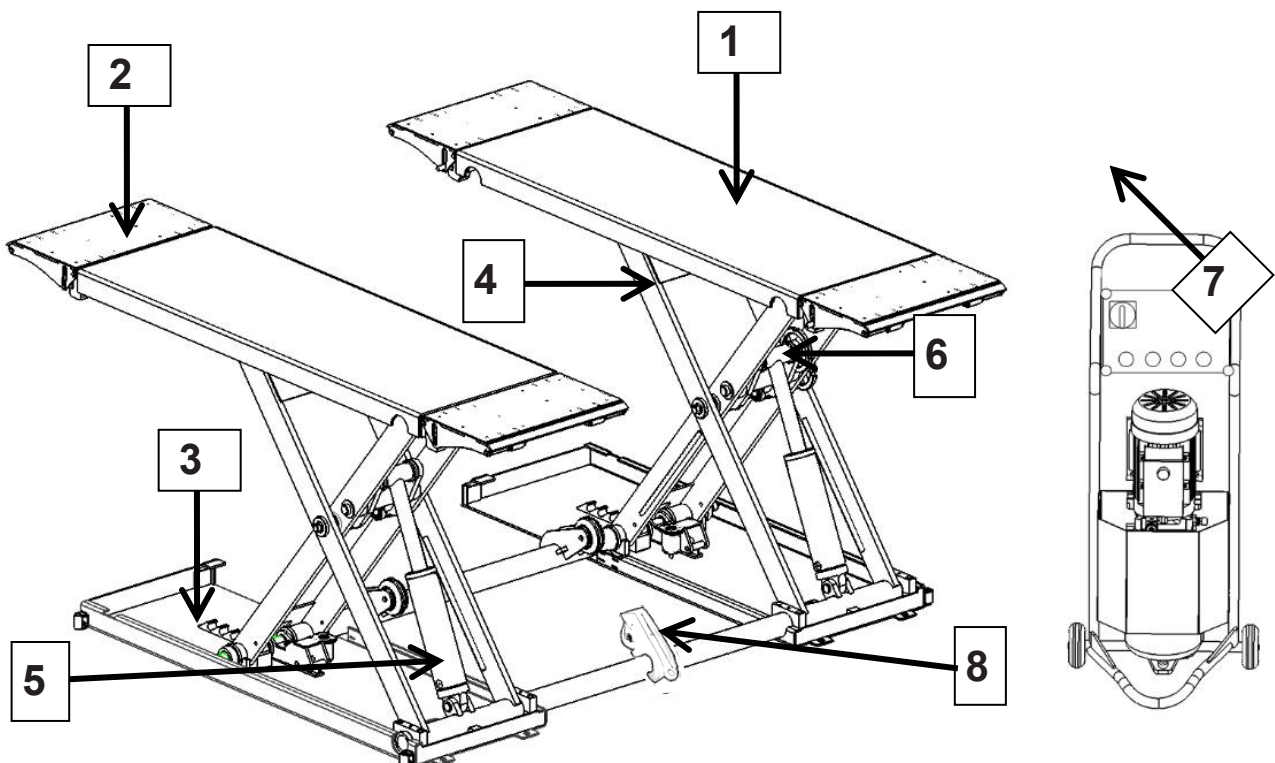

platforms (1) each equipped with N.2 ramps (2) which can be locked as the platform extensions, placed on the ground by means of base frames (3).

Platforms are linked to the base frame by means of a scissor lifting system. The lifting system of each platform is composed of arms (4) and a cylinder (5).

Motion is transmitted by a lever system, from the cylinders to the lever arm (6). Lowering and lifting are carried out by operation of the control unit (7) which is removable.

The mechanical safety locks operated by pneumatic cylinders are installed at each base and controlled by the control panel. The lift is equipped with a bolster beam in front to keep the two platforms level during lifting and lowering.

N.3 wheels (8) can be installed on the lifts so that the lift can be mobile by means of a hook on the power unit carriage.

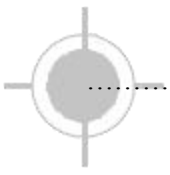

Technical Specification

4.1 Size And Main Features

CAPACITY	3500kg /7,716 LBS.
Max. lifting height	1050mm/41" (With positioning)
Min. lift height	110mm/4.33"
Length of the platform	1430-2036mm/56.3-80.16"
Width of platform	500mm/19.69"
Free width between platforms	860mm/33.86
Overall length	2036mm/80.16"
Overall width	1860mm/43.23
Lifting time	35s
Lowering time	40s
Compressed air pressure	85-120 psi.
Noise level	80 dB(A)/1m
Working temperature	14 °F - 104 °F
The weight of these two packages	600kg/1323LBS.

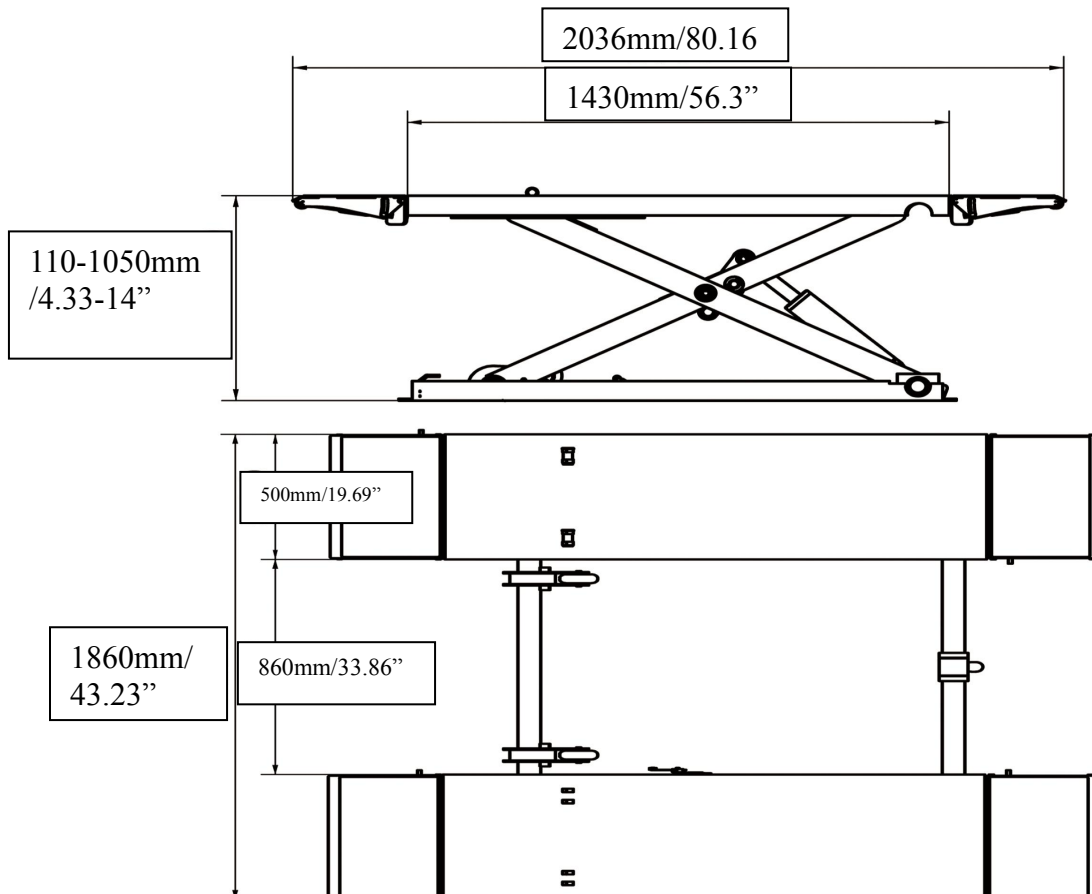

4.2 Hydraulic Power Unit

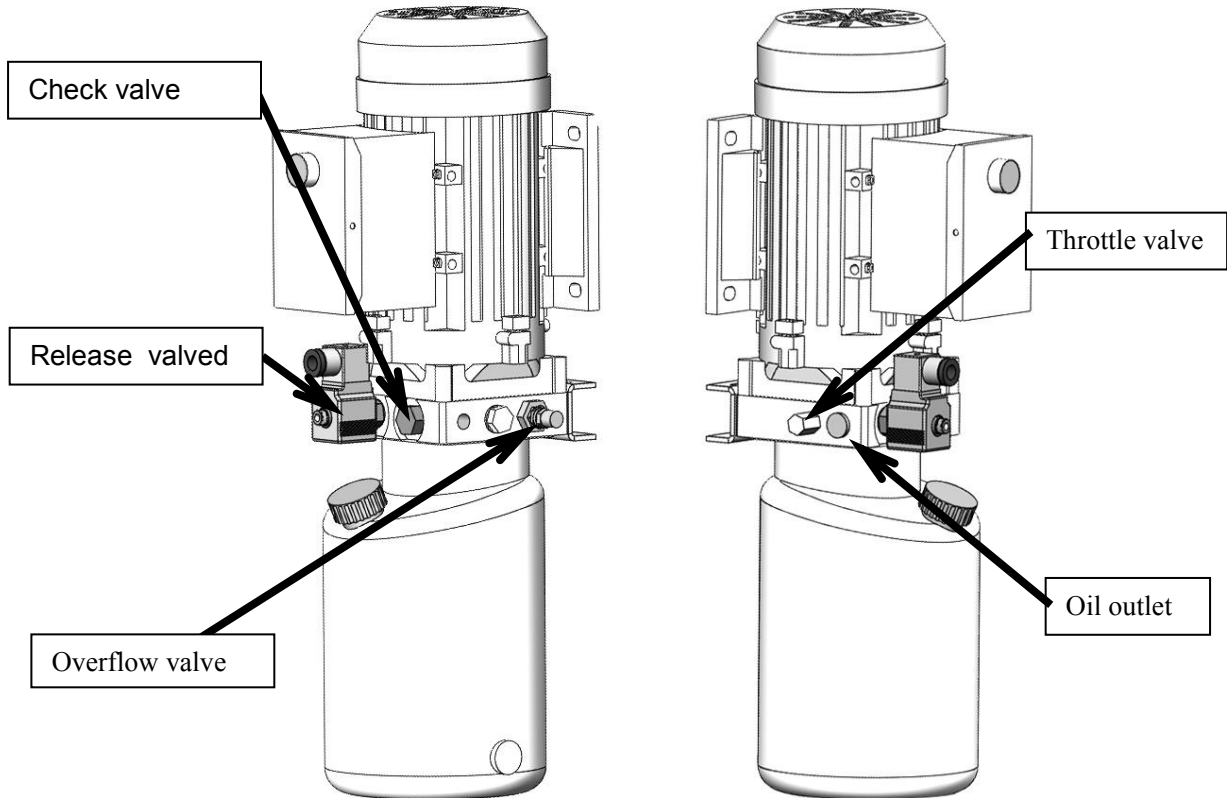

4.3 Oil

Use wear proof oil for hydraulic drive, in conformity with *ISO 6743/4* rules(HM class). The oil with features similar to those shown in the table is recommended.

Test standards	Features	Value
ASTM D 1298	Density 20°C	0.8 kg/l
ASTM D 445	Viscosity 40°C	32 cSt
ASTM D 445	Viscosity 100°C	5.43 cSt
ASTM D 2270	Viscosity index	104 N°
ASTM D 97	Pour point	~ 30 °C
ASTM D 92	Flash point	215 °C
ASTM D 644	Neutralization number	0.5 mg KOH/g



Change hydraulic oil at 1 year intervals

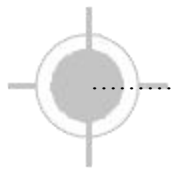

Electrical Wiring Diagram

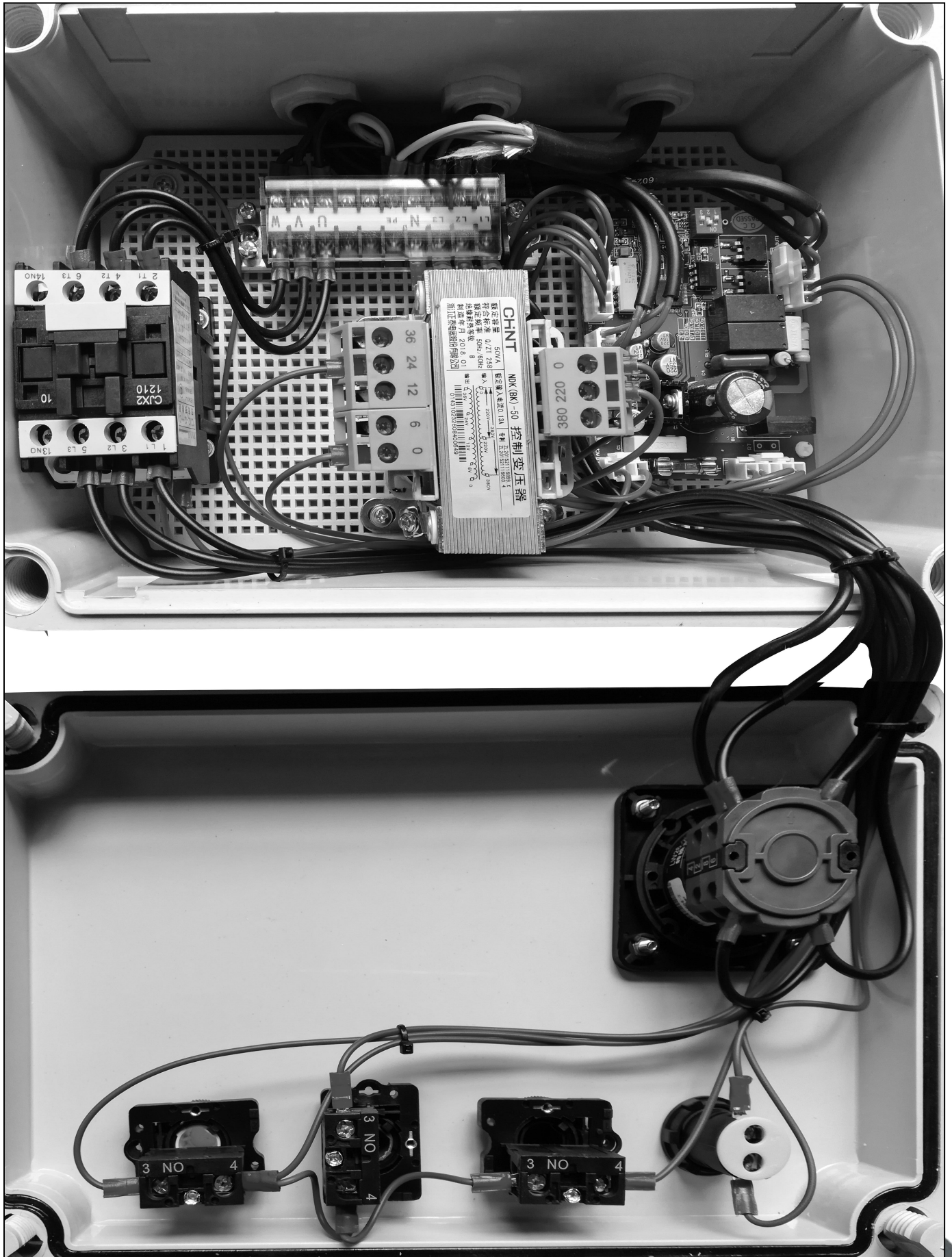



Safety

Read this chapter carefully and completely because it contains important information for the safety of the operator and the person in charge of maintenance.

	<p>The lift has been designed and built for lifting vehicles and making them stand above level in a closed area. Any other use is forbidden.</p> <p>The manufacturer is not liable for possible damages to people, vehicles or objects resulting from an improper or unauthorized use of the lift.</p>
---	--

For operator and people safety, a safety area at least 1m free away from the lift must be vacated during lifting and lowering. The lift must be operated only from the operator's control site in this safety area.

Operator's presence under the vehicle, during working, is only admitted when the vehicle is lifted and platforms are not running.

	<p>Never use the lift when safety devices are off-line. People, the lift and the vehicles lifted can be seriously damaged if these instructions are not followed.</p>
---	--

5.1 General Warnings

The operator and the person in charge of maintenance must follow accident- prevention laws and rules in force in the country where the lift is installed

They also must carry out the following:

- neither remove nor disconnect hydraulic, electric or other safety devices;
- carefully follow the safety indications applied on the machine and included in the manual;
- observe the safety area during lifting;
- be sure the motor of the vehicle is off, the gear engaged and the parking brake put on;
- be sure only authorized vehicles are lifted without exceeding the maximum lifting capacity;
- Verify that no one is on the platforms during lifting or standing.



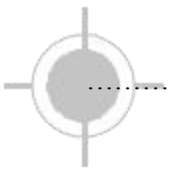

5.2 Risks During Vehicle Lifting

To avoid overloading and possible breaking, the following safety devices have been used:

- a maximum pressure valve placed inside the hydraulic unit to prevent excessive weight.
- a special design of the hydraulic system, in case of pipeline failure, to prevent sudden lift lowering.

	The maximum pressure valve has been preset by the manufacturer to a proper pressure. DO NOT try to adjust it to overrun the rated lifting capacity.
--	--

5.3 Risks For People

All risks the personnel could run, due to an improper use of the lift, are described in this section.

5.4 Personnel Crushing Risks

During lowering of runways and vehicles, personnel must not be within the area covered by the lowering trajectory. The operator must be sure no one is in danger before operating the lift.

5.5 Bumping Risk

When the lift is stopped at relatively low height for working, the risk of bumping against projecting parts occurs.

5.6 Risk Of The Vehicle Falling From The Lift

Vehicle falling from the lift can be caused when the vehicle is improperly placed on platforms, and when

its dimensions are incompatible with the lift or by excessive movement of the vehicle. In this case, keep immediately away from the working area.





5.7 Slipping Risks

The risk of slipping can be caused by oil or dirt on the floor near the lift.

	Keep the area under and around the lift clean. Remove all oil spills.
---	--

5.8 Electrocutation Risks

Avoid use of water, steam, and solvent, varnish jets in the lift area where electric cables are placed and, in particular, next to the electric panel.

5.9 Risks Resulting From Improper Lighting

Make sure all areas next to the lift are well and uniformly lit, according to local regulations.

5.10 Risks Of Breaking Component During Operation

Materials and procedures, suitable for the designed parameters of the lift, have been used by the manufacturer to build a safe and reliable product. Operate the lift only for the use it has been designed for and follow the maintenance schedule shown in the chapter "Maintenance".

5.11 Risks For Unauthorized Uses

The presence of unauthorized persons next to the lift and on the platforms is strictly forbidden during lifting as well as when the vehicle has been already lifted.

	Any use of the lift other than that herein specified can cause serious accidents to people in close proximity of the machine.
---	--



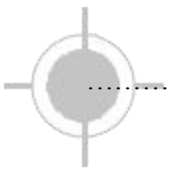

Installation



Only skilled technicians, appointed by the manufacturer, or by authorized dealers, must be allowed to carry out installation. Serious damage to people and to the lift can be caused if installations are made by unskilled personnel.

6.1 Checking For Place Suitability

The lift has been designed to be used in covered and sheltered places free of overhead obstructions.

The working place must not be next to washing areas, painting workbenches, solvent or varnish deposits. The relevant standards of the local Health and Safety at Work regulations, for instance, with respect to minimum distance to wall or other equipment, escapes and the like, must be observed.

All areas next to the lift must be well and uniformly lit.

6.2 Concrete Surface

The lift must be placed on the concrete surface sufficiently resistant. The surface must be suitable for bearing maximum stress values, also in unfavorable working conditions. The surface must be perfectly leveled.

6.3 Hydraulic System Connection

- Connect hydraulic hoses referring to
- Tighten fittings thoroughly.

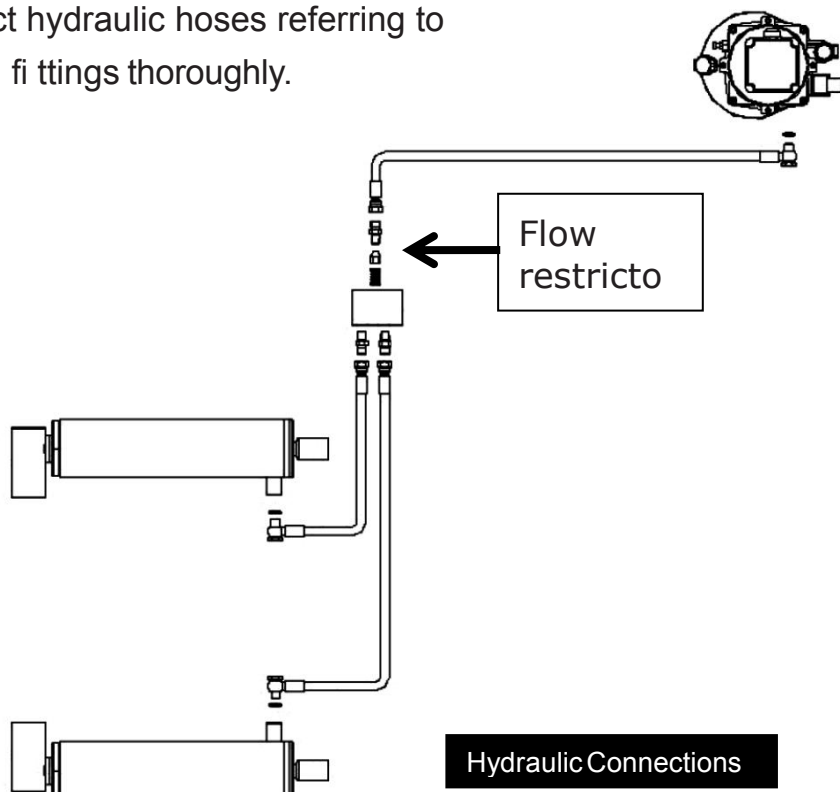

6.4 Make The Electrical Hookup To Hydraulic Power Unit



The hookup work must be carried out by a qualified electrician. Make sure that the power supply is right.

Make sure the connection of the phases is right. Improper electrical hook-up can damage motor and will not be covered under warranty.

DO NOT run the hydraulic unit with no oil. Damage to pump can occur.

The power unit must be kept dry.

- Make the electric hookup to the power unit referring to the attached using the included electric cable.
- Make sure the connection of the phases is right and lift is grounded.

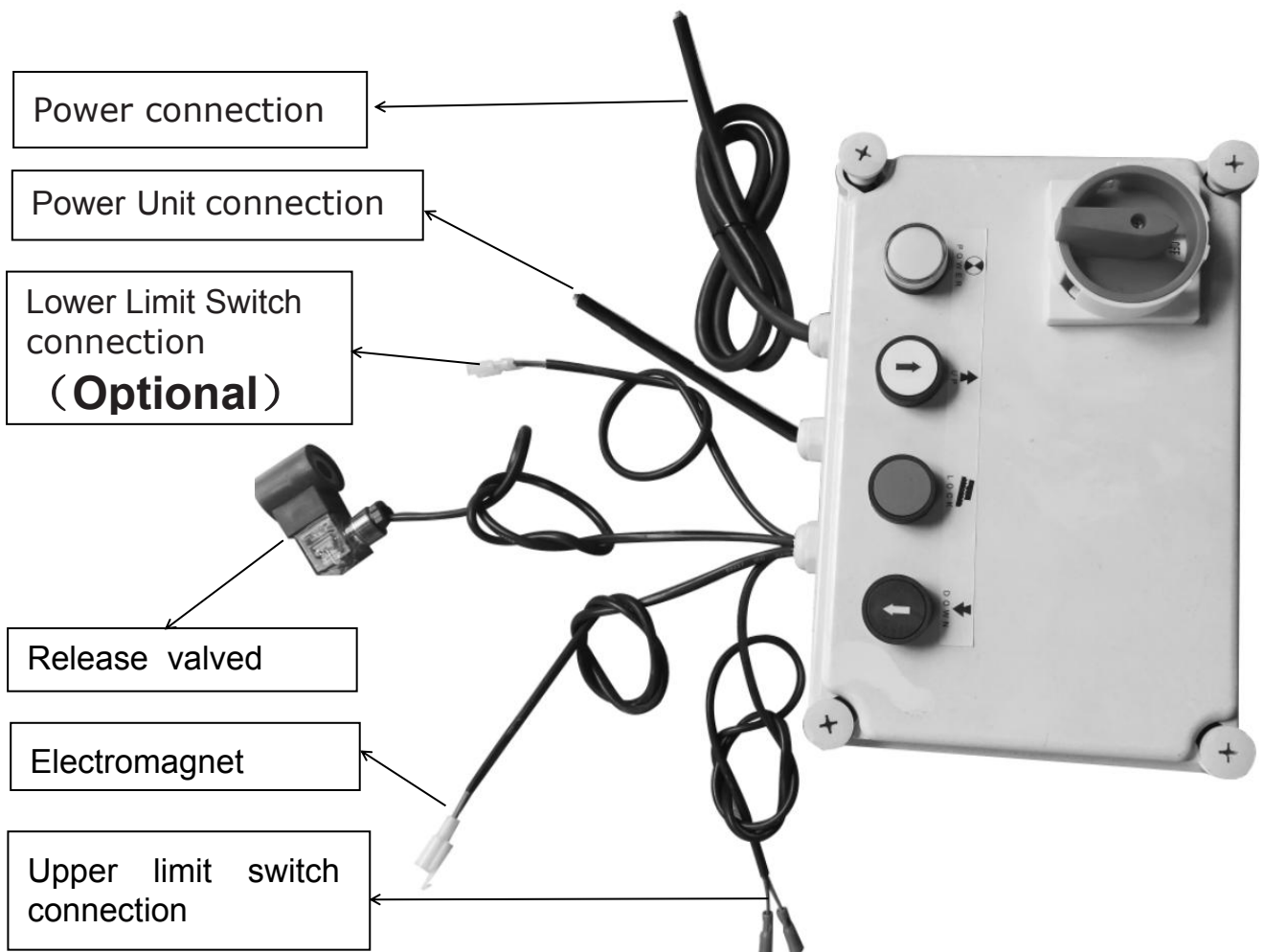

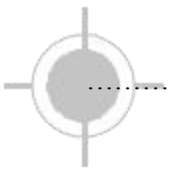

6.5 Pneumatic System Connection



When routing the pneumatic line, make sure that the line is clear of any moving part. Failure to do so may result in safety lock failure which may result in damage or personal harm.

The pneumatic supply at site (to which the pneumatic system of the lift is connected) must be equipped with a servicing unit composed of water separator, lubricator and pressure reducer. These devices can be supplied by the manufacturer on request.

For the connection of the pneumatic lines proceed as follow:

- Connect the pneumatic lines pre-assembled on the lift to the solenoid air valve in the control unit according to the pneumatic plan
- Connect the pneumatic system of the lift to the pneumatic supply at site;
- Check the pneumatic control operations for proper performance.

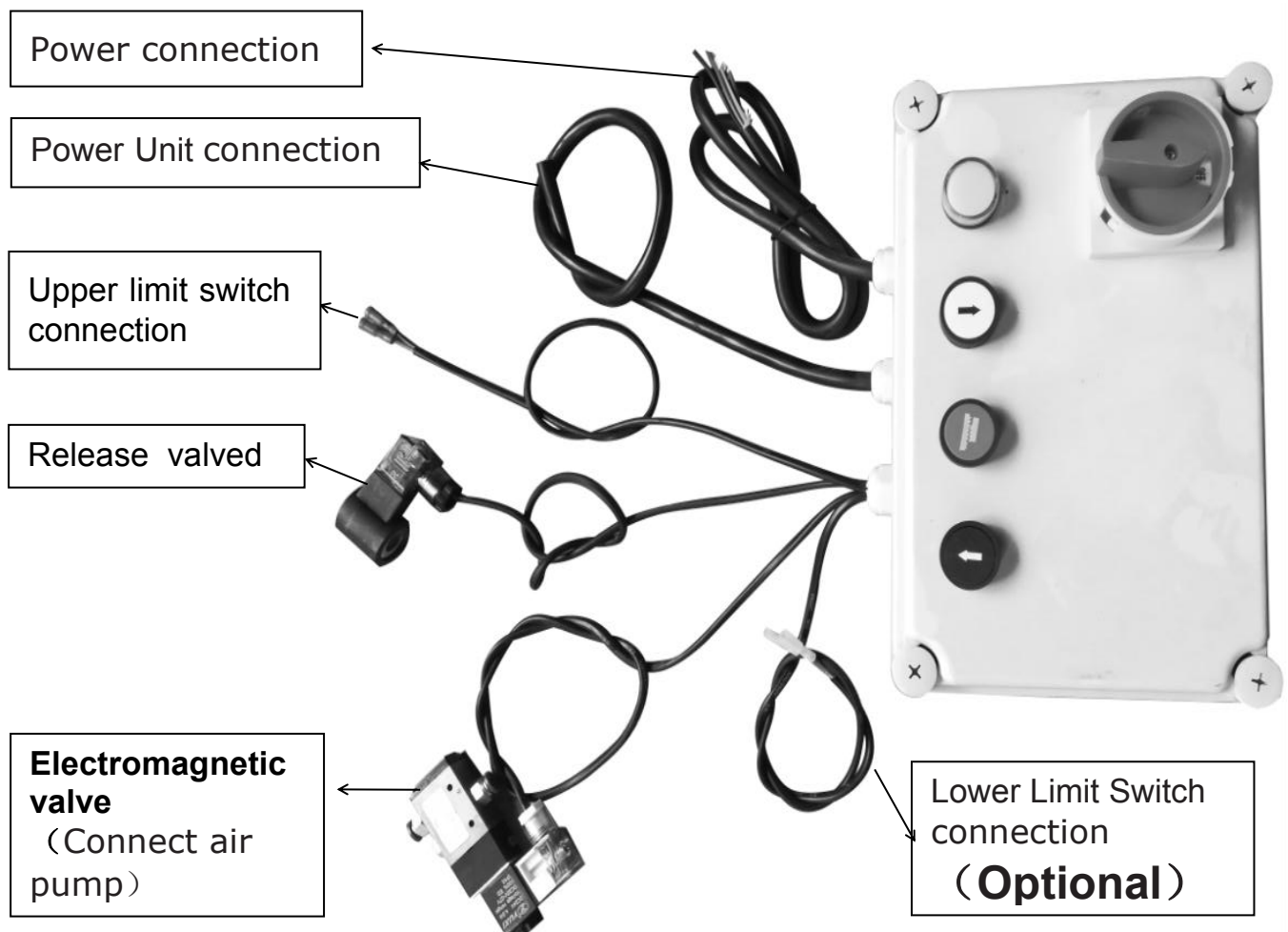



6.6 Start



During this procedure, DO NOT attempt to raise the lift with any load.

- Make sure all pins and bolts to insure proper mounting
- Make sure the electrical system feeding voltage is equal to that specified in the nameplate on the motor
- Make sure the electric connections are in compliant with diagrams
- Make sure no leakage or blow-up in hydraulic line
- Make sure the working area is free from people and objects
- Grease sliding seats of blocks placed under platforms and on bases
- Pour oil in the tank (*about 5 liters more than one time*)
- Verify that the control unit is powered
- Verify that the motor direction of rotation is that shown on the label by pressing the lifting button. IF MOTOR GETS HOT OR SOUNDS PECULIAR, STOP IMMEDIATELY AND RECHECK THE ELECTRIC CONNECTIONS
- Raising the lift slowly by pressing the lifting button until cylinders bottom out and the lift stops. DO NOT continue pressing button after lift reaches full height. Damage to motor can occur if continued.
- Repeat raise and lower the lift completely at least 3 times to equalize the oil pressure in each cylinder.

6.7 Checks Less Load



During this procedure, observe all operating components and check for proper installation and adjustment. DO NOT attempt to raise vehicle until a thorough operation check has been completed.

Carry out two or three complete cycles of lowering and lifting and check:

- the safety devices for proper operation
- proper oil level in the tank
- no leakage and blow-by in hydraulic line and pneumatic line
- cylinder for proper operation
- the lift for reaching its maximum height
- the horn/signaling light for proper operation during the final travel



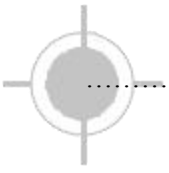

6.8 Checking With Load



WARNING: The lift must be raised at least 12" out of the ground before taking the load.



It is extremely forbidden to load the vehicle when the lift wheels are on the lift. Failure to do so can damage the lift severely.

Carry out two or three complete cycles of lowering and lifting and check:

- the safety devices for proper operation
- proper oil level in the tank
- no leakage and blow-by in hydraulic line and pneumatic line
- cylinder for proper operation
- the lift for reaching its maximum height
- the horn/signaling light for proper operation during the final travel

Check no strange noise during lifting and lowering





Operation And Use



Never operate the lift with any person or equipment below.
Never exceed the rated lifting capacity.
Do not permit the electric control unit to get wet!

7.1 Controls

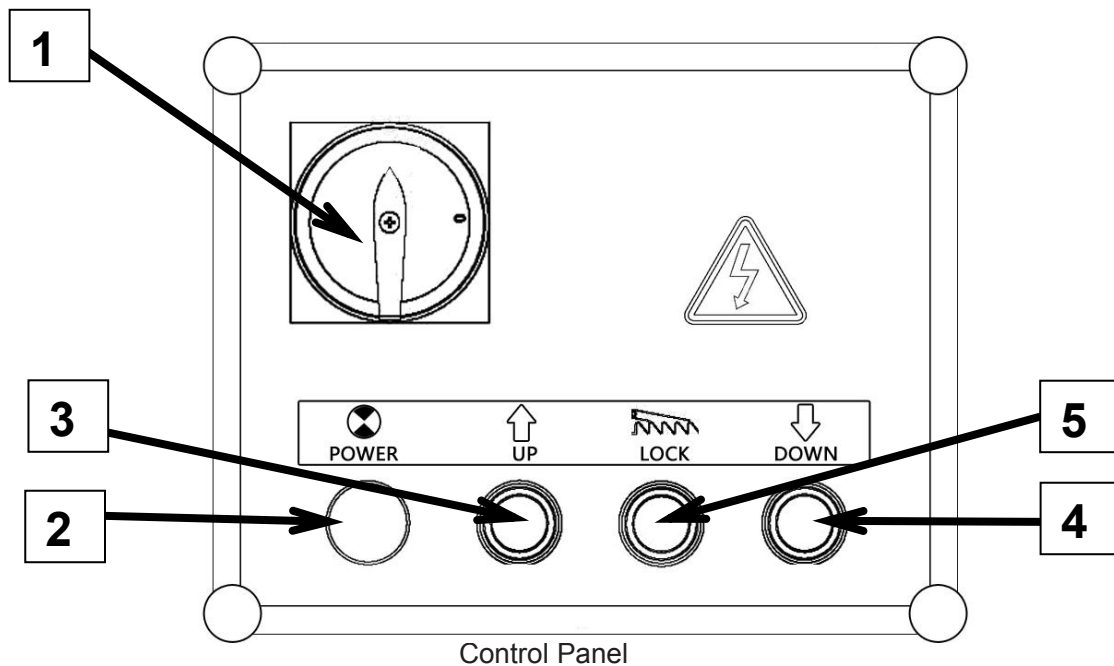

Controls for operating the lift are:

POWER SWITCH (1)

The switch can be set in two positions:

OFF: the lift electric circuit is not powered; the switch can be padlocked to prevent the use of the lift.

ON: the main electric circuit is powered



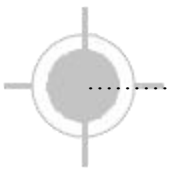

POWER (2)

- It shows that the electric circuit is powered

UP (3)

- When pressed, the electric circuit for the lift operates the motor and hydraulic circuit to raise the lift

DOWN (4)

- When pressed, the lift will be raised a little bit to release the safety, and a few seconds later the lift begins to descend under its weight and the load lifted

LOCK (5)

- When pressed, the lowering solenoid valve operates the hydraulic circuit to lower the lift to engage the nearest mechanical safeties.

7.2 To Raise The Lift



It is extremely forbidden to load the vehicle when the mobile wheels are on the lift. Failure to do so can damage the lift severely.



The lift must be raised at least 12" off of the ground before taking the load.



Raise a vehicle to a desired height, perform the necessary service work, and then lower the vehicle to the ground **WITHOUT** engaging the pneumatic positive lock bar system. The pneumatic positive locking system will automatically engage in the unlikely event of a hydraulic failure while the vehicle is in the air. If the vehicle is to be "stored" on the raised lift platforms for an **extended period of time** then the pneumatic positive lock system needs to be activated (by the user).

When the vehicle service work has been completed and the operator wants to lower the vehicle to the ground (or to a lower "locked position"), please follow these important steps and remember:

IT IS IMPERATIVE THAT THE LOCK BARS BE COMPLETELY DISENGAGED WHEN THE VEHICLE IS BEING LOWERED TO THE GROUND. FAILURE TO FULLY DISENGAGE BOTH LOCK BARS DURING THE LOWERING PROCESS WILL CAUSE FRAME DAMAGE TO THE LIFT.

When the console's DOWN Button is pressed (to lower the vehicle), it is **IMPERATIVE** for the operator to

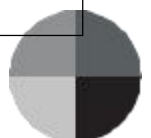

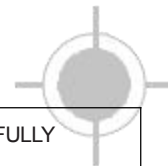

physically check to make sure that the lift platforms raise up enough to allow BOTH Safety LockBars to FULLY disengage from the Safety Lock Bars mounted on the frame. Neither of the Safety Lock Bars should engage the frame's lock bar if the lift is to be lowered all the way to the ground.

If one (but not both) of the lock bars should engage before the lift reaches the ground, (platforms will become unlevel) then damage to the lift frame may occur.

If the operator does NOT WANT TO LOWER THE VEHICLE ALL THE WAY TO THE GROUND, (perhaps only a few inches from the current raised position), then the operator must make sure that both of the Safety Lock Bars are fully disengaged during the lowering process. After pressing the "DOWN" button on the remote console, the platforms begin to move down and the lock bars release (disengage). As the lift platforms

descend to the desired lower locking position (lock bars are disengaged), the operator should make sure that when the desired position is reached that both lock bars fully engage the frame's horizontal Safety Lock Bars at the same time and at the same position so that the platforms remain LEVEL.

- Position the vehicle at the centre of the platform. Check to make sure that the vehicle is secured.
- Place the pads in the positions;
- Set the power switch to 1 position;
- Press the lifting button to raise the vehicle;
- To rest the lift in standing position at the desired height by releasing the lifting button;

7.3 To Lower The Lift

- Be sure the safety area is free of people and objects;
- Press the lowering button, the lift will be raised a little bit to assure the release of the safeties;
- Keep pressing the lowering button to lower the lift completely.

7.4 To Move The Lift

When the lift needs to be moved, proceed as below:

- Place the lift at a proper height;
- Attach the hook placed on the carriage to the hole placed universal wheel hole on the front beam
- Pull the carriage to move the lift.





Maintenance



Only trained personnel who knows how the lift works, must be allowed to service the lift.

To service properly the lift, the following has to be carried out:

- use only genuine spare parts as well as equipment suitable for the work required;
- follow the scheduled maintenance and check periods shown in the manual;
- discover the reason for possible failures such as too much noise, overheating, oil blow-by, etc.

Refer to documents supplied by the dealer to carry out maintenance:

- functional drawing of the electric/Pneumatic and hydraulic equipment
- exploded views with all data necessary for spare parts ordering
- list of possible faults and relevant solutions.



Before carrying out any maintenance or repair on the lift, disconnect the power supply, padlock the general switch and keep prevent unauthorized persons from switching on or operating the lift.

8.1 Ordinary Maintenance

The lift has to be properly cleaned at least once a month using self-cleaning clothes. Lubricate all pivot pins at least once a week.



The use of water or inflammable liquid is strictly forbidden.

Be sure the rod of the hydraulic cylinders is always clean and not damaged since this may result in leakage from seals and, as a consequence, in possible malfunctions.

8.2 Periodic Maintenance

Every 3 months	Hydraulic circuit	<ul style="list-style-type: none">• check oil tank level; refill with oil, if needed;• check the circuit for oil leakage.• check seals for proper conditions and replace them, if necessary;
	Foundation bolts	<ul style="list-style-type: none">• check bolts for proper tightening
	Hydraulic pump	<ul style="list-style-type: none">• verify that no noise changes take place in the pump when running and check fixing bolts for proper tightening
	Safety system	<ul style="list-style-type: none">• check safety devices for proper operation
Every 6 months	Oil	<ul style="list-style-type: none">• check oil for contamination or ageing. Contaminated oil is the main reason for failure of valves and shorter life of gears pumps
Every 12 months	General check	<ul style="list-style-type: none">• verify that all components and mechanisms are not damaged
	Electrical system	<ul style="list-style-type: none">• a check of the electrical system to verify that motor, limit switch and control panel operate properly must be carried out by skilled electricians
	Oil	<ul style="list-style-type: none">• empty the oil tank and change the hydraulic oil

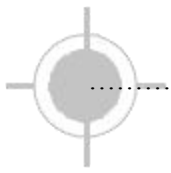

Troubleshooting

A list of possible troubles and solutions is given below

Troubl	Possible Cause:	Solution:
The lift does not work	The main switch is not turned on	Turn the switch on
	There is no power	Check Power on to restore if necessary
	The electrical wires are disconnected	Reconnect
	Fuses are blown	Replace
	The maximum height limit switch is faulty.	Check the switch and relevant connection for proper operation. Replace, if needed.
The lift does not raise	The motor direction of rotation is not correct.	Interchange the two phases on the main switch
	The oil in the hydraulic unit is not sufficient.	Add some hydraulic oil
	Presences of air in the hydraulic circuit	Bleed the hydraulic system
	The UP button is faulty.	Check UP button and connection for proper operation. Replace, if needed
	The maximum pressure valve is faulty	Check and clean if dirty or replace if needed
	The lowering solenoid valve does not open.	Check and clean if dirty or replace if faulty
	The emergency screw of lowering solenoid valve does not close	Retighten the screw
	The pump filter is dirty.	Check and clean if needed.
	The pump suction is blown	Check the seal and replace if needed
The platforms are not leveled	Oil leakages in hydraulic circuit	Check the circuit for any leakage
The lift does not lower when the DOWN button is pressed	The lowering solenoid valve does not work properly	Verify if it is powered and check magneto for damage (replace if disconnected or blown).
	The DOWN button is faulty	Check and replace if needed
	The pressure of compressed air is not sufficient to clear of the safety lock	Adjust air pressure
The lift does not lift or lower smoothly	Leakages or presences of air into hydraulic circuit	Bleed the hydraulic system
	The pump filter is dirty.	Check and clean if needed.
	The pump suction is blown	Check the seal and replace if needed

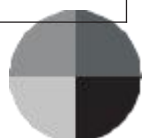



Warranty

This item is warranted for one (1) years on hydraulic power units and cylinders from invoice date.

NOTE: ALL WARRANTY CLAIMS MUST BE PRE-APPROVED BY THE MANUFACTURER TO BE VALID.

The shall repair or replace at their option for this period those parts returned to the factory freight prepaid, which prove after inspection to be defective.

This warranty will not apply unless the product is installed, used and maintained in accordance with the Manufacturers installation, operation and maintenance instructions.

This warranty applies to the ORIGINAL purchaser only, and is non-transferable. The warranty covers the products to be free of defects in material and workmanship but, does not cover normal maintenance or adjustments, damage or malfunction caused by: improper handling, installation, abuse, misuse, negligence, carelessness of operation or normal wear and tear. In addition, this warranty does not cover equipment when repairs or alterations have been made or attempted to the Manufacturer's products.

THIS WARRANTY IS EXCLUSIVE AND IS LIEU OF ALL OTHER WARRANTIES EXPRESSED OR IMPLIED INCLUDING ANY IMPLIED WARRANTY OR MERCHANTABILITY OR ANY IMPLIED WARRANTY OF FITNESS FROM A PARTICULAR PURPOSE, AND ALL SUCH IMPLIED WARRANTIES ARE EXPRESSLY EXCLUDED.

specifications are subject to change without notice

RETURNS: Products may not be returned without prior written approval from the Manufacturer.



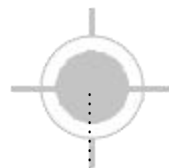

Parts List

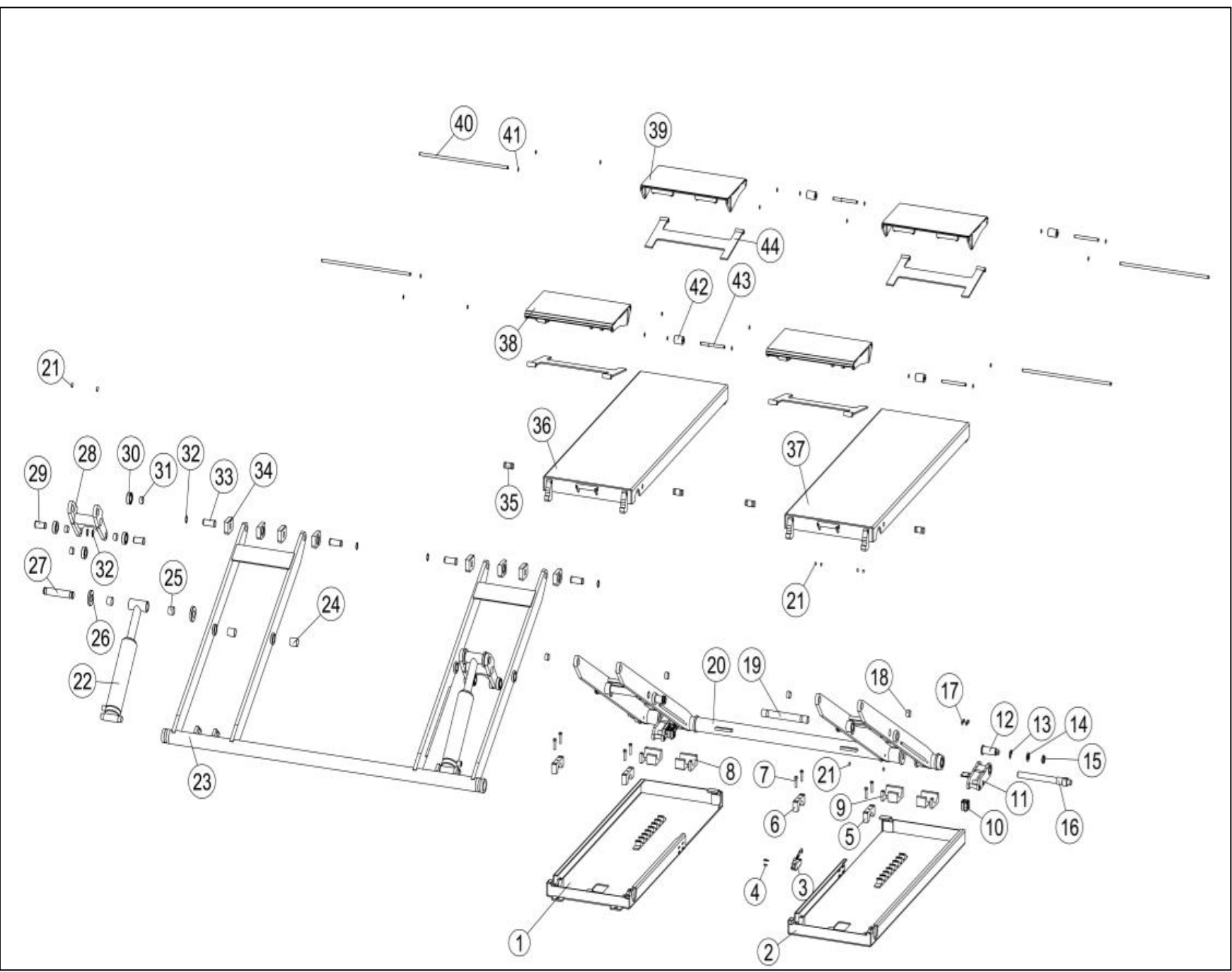



Nos.	Part Nos.	Name	Quantity
1	YL-ZWXJ-01-01-00A	Left base welding	1
2	YL-ZWXJ-01-01-00B	Right base welding	1
3	8108	Limit switch	1
4	RH000510	Snap-head bolt M5X10	4
5	YL-ZWXJ-00-01	Top tile seat (without platform)	2
6	YL-ZWXJ-00-02	Top tile seat (with platform)	2
7	IH001045	inside hexagonal bolt M10X45	8
8	YL-ZWXJ-00-03	Bottom slide block(left)	2
9	YL-ZWXJ-00-04	Bottom slide block(right)	2
10	SDA-20*15 M5	Thin cylinder	2
11	YL-ZWXJ-06-00	Lock frame	2
12	YL-ZWXJ-00-05	Middle axle	4
13	YL-ZWXJ-00-06	Flower mat	4
14	W002000	Φ20 flat washer	4
15	YL-ZWXJ-00-07	Round nut M20	4
16	YL-ZWXJ-00-08	Fixed shaft for lock frame	2
17	RH000512	Snap-head bolt M5X12	8
18	SF-2530	Oilless bearing	4
19	YL-ZWXJ-00-09	Fixed shaft for power arm	2
20	YL-ZWXJ-03-00	Internal arm welding	1
21	ST000810	Jackscrew M8X10	16
22		Oil cylinder	2
23	YL-ZWXJ-02-00	Outside arm welding	1
24	SF-3025	Oilless bearing	4
25	SF-3050	Oilless bearing	4
26	YL-ZWXJ-00-10	Oil cylinder casing	4
27	YL-ZWXJ-00-11	Fixed shaft on cylinder	2
28	YL-ZWXJ-04-00	Power arm welding	2
29	YL-ZWXJ-00-12	The fixed axis for power arm walking wheel	4
30	YL-ZWXJ-00-13	Power arm walking wheel	8
31	SF-2515	Oilless bearing	8
32	RE002500	Φ25 clamp spring	14
33	YL-ZWXJ-00-14	Upper cover slide shaft	4
34	YL-ZWXJ-00-15	Upper cover slider	4
35	YL-ZWXJ-00-16	Top cover fixed shaft	4
36	YL-ZWXJ-05-01-00A	top left cover plate welding	1
37	YL-ZWXJ-05-01-00B	top right cover plate welding	1
38	YL-ZWXJ-07-01-00A	Left mounting plate welding	2
39	YL-ZWXJ-07-01-00B	Right mounting plate welding	2
40	YL-ZWXJ-00-17	Mounting plate fixed shaft	4
41	RE001200	Φ12 clamp spring	30
42	YL-ZWXJ-00-18	Mounting plate walking wheel	8
43	YL-ZWXJ-00-19	Mounting plate walking axle	8
44	YL-ZWXJ-00-20-00	Mounting plate bracket welding	4