

# MYSTIC INSTALLATION

PROPER INSTALLATION IS IMPORTANT. IF YOU NEED ASSISTANCE, CONSULT A CONTRACTOR, ELECTRICIAN OR TELEVISION ANTENNA INSTALLER (CHECK WITH YOUR LOCAL BUILDING SUPPLY, OR HARDWARE STORE FOR REFERRALS). TO PROMOTE CONFIDENCE, PERFORM A TRIAL WIRING BEFORE INSTALLATION.

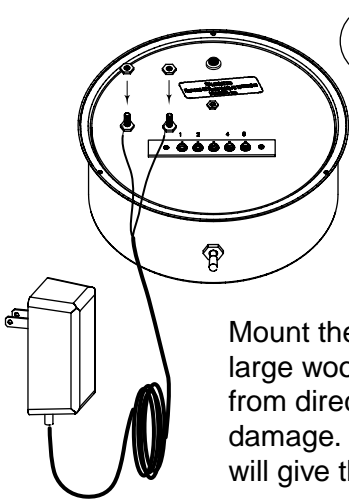

- 1 Connect the AC adapter to Mystic and plug into outlet. The display will briefly light up all the indicator lights (self test). Next the display will show the unit of measurement codes and then will show the barometer function light and the center display will show a pressure reading. **Leave Mystic in this mode for two hours. Do not activate the switch at the bottom of the case.** At the end of this two hour period, Mystic will be ready to have the pressure adjustment performed.

Mount the temperature sensor assembly with the two large wood screws. Select a location that is protected from direct sunlight and sheltered from rain and physical damage. (A north exposure, six feet above the ground will give the best results.)

Form a drip loop with the wire at least eight inches below the exit from the sensor and at least eight inches below the point of entry into the building. Anchor any exposed wire with insulated cable clips. Run the wire through the building to the location where the indicator will be located. Caulk any holes when done.

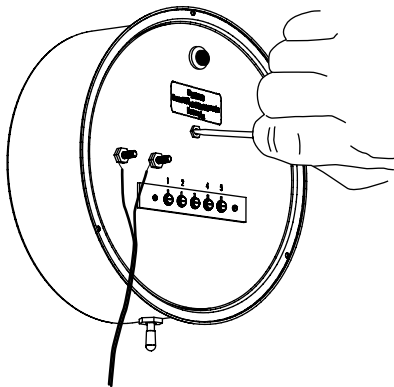
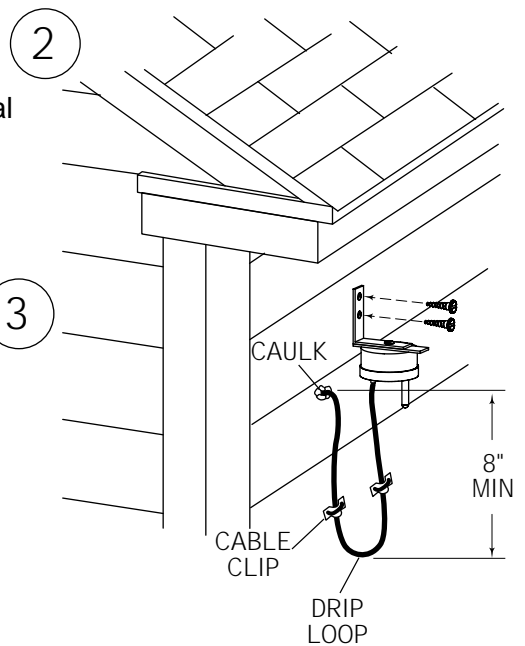

- 4 Now calibrate the barometer for your altitude. Obtain the current barometric pressure for your area by calling a near-by airport or an individual who has a properly set barometer. Insert a small screw driver into the recessed slotted screw at the back of Mystic. Turn the screw while observing the pressure read out on the front of Mystic. Due to the sensitivity of this adjustment, the numbers on the display may fluctuate during this procedure. It may take a minute to achieve the exact setting. Once the unit is set, move the toggle switch to the right (auto) one time to lock in the setting.

- 5 Unplug the AC adaptor and disconnect the wires. Mystic is now ready for the final installation. The adjustment that you have made will always remain intact.

*MAXIMUM* INC.

30 Samuel Barnet Boulevard  
New Bedford, MA 02745  
(508) 995-2200

# MYSTIC INSTALLATION (CONT.)

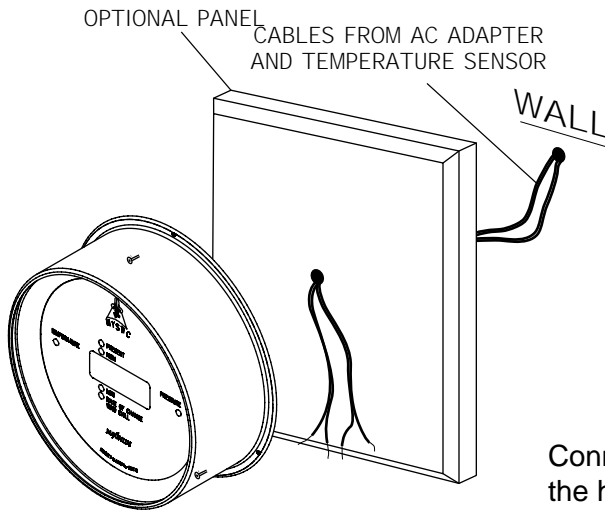

6

Feed the cables from the AC adapter and the temperature sensor through the wall to Mystic. We recommend using one of our pre-drilled panels for mounting Mystic. Take precautions to avoid crimping the wires under the lip of the brass readout.

7

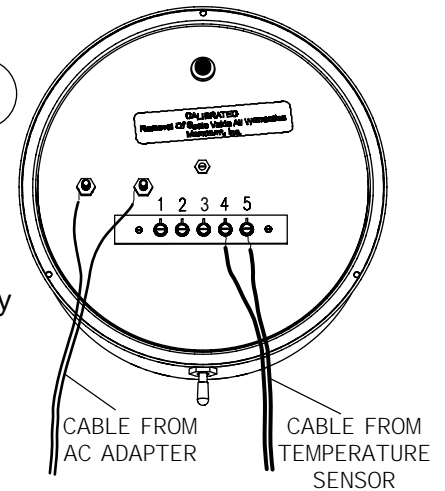

Connect the AC adapter wires with the hex nuts. The polarity does not matter. Connect the two wires from the air-temperature sensor to terminals 4 and 5. Again, the polarity does not matter.

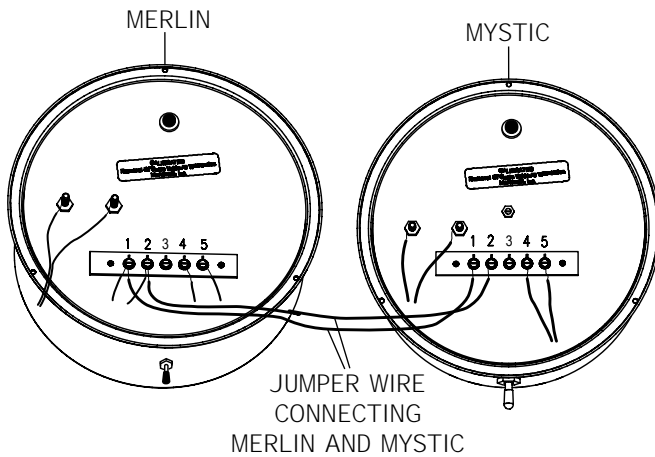

8

If you own a Merlin, connect the jumper wire (supplied) to terminals #1 and #2 on Merlin. There will now be two wires connected to terminals #1 and #2. Connect the other end of the jumper wires to terminals #1 and #2 of Mystic. Note that terminal #1 of Merlin connects to terminal #1 of Mystic and #2 connects to #2.

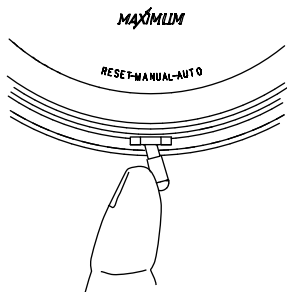

9

Plug the AC adaptor into a 110VAC outlet. Mystic will power up and self test briefly then the center display will show the pressure adjustment mode. You must exit the adjustment mode by moving the switch to Auto and releasing it.

**NOTE:** After any full reset, Mystic will display the pressure adjustment mode. It is never necessary to perform the pressure adjustment again. Simply exit this mode by moving the switch to Auto and releasing it.

*MAXIMUM* INC.

30 Samuel Barnet Boulevard  
New Bedford, MA 02745  
(508) 995-2200

# MYSTIC OPERATION

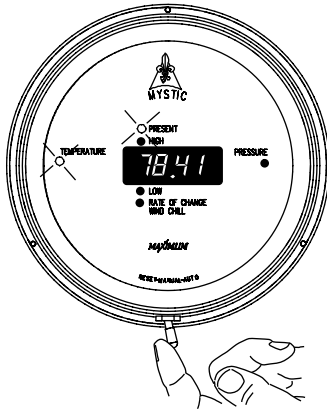

Move the toggle switch at the bottom of the case to the right (auto) and allow it to return. This manually moves the Mystic through the individual functions. The illuminated function LED's indicate which function and setting is being displayed.

Moving the toggle switch to the right (auto) and holding it for at least three seconds will put Mystic into its Auto sequencing mode. You will see each function light stay on and that particular information displayed for approximately four seconds and then move to the next function automatically.

If Mystic is Auto sequencing and you wish to turn that function off - move the toggle switch to the right (auto) and release it. You can now manually step through the functions as previously mentioned.

Any Individual function's memory can be independently reset. Move the toggle switch to the right (auto) until that particular function is displayed. Then move the toggle switch to the left (reset) and hold it for six seconds. The display will quickly blank, indicating that the memory for that function has been reset.

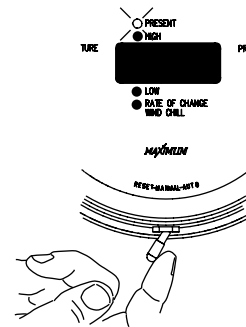

A "FULL" reset may also be done to clear all memories simultaneously or if an adjustment to the barometer setting is needed. Toggle through Mystics settings until the "Present" function is displayed. Then move the toggle switch to the left (reset) and hold it for six seconds. The display will self-test and enter into the barometer adjustment mode. If necessary the barometer may be reset at this time by adjusting the set screw on the backplate. Exit the barometer adjustment mode by moving the toggle switch to the right (auto) and releasing it.

**NOTE:** After any "FULL" reset, temperature and/or wind chill data will be displayed and stored after ten seconds. Pressure data will be displayed and stored after two minutes. However, Rate of Change/Pressure will show "HOLD" for 72 minutes following a "FULL" reset.

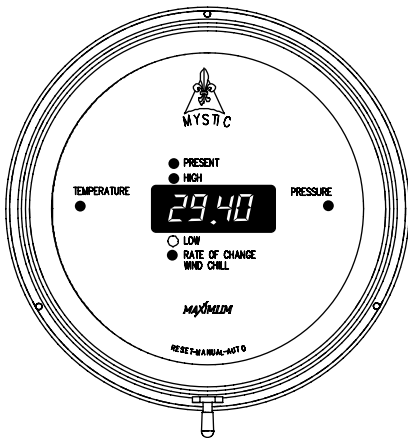

When the toggle switch is in the center position Mystic will display the information that is indicated by the function light. All the other functions data are being recorded and stored.

**MAXIMUM** INC.  
30 Samuel Barnet Boulevard  
New Bedford, MA 02745  
(508) 995-2200

# MYSTIC

## OPERATION (CONT.)

Mystic can be set to display the temperature in Fahrenheit or Celsius. The barometric pressure can be set to inches of mercury, millimeters of mercury, millibars or kilopascals. To change the units of measurement follow these steps:

1. Press the small push button switch on the back of the indicator. The display will show "F" or "C"
2. Press the push button again to advance through the available units.
3. When you have the code showing for the units of measurement you want. Press the toggle switch on the side of the case to the right (auto position). The display will now show "P" and a number. The number indicates the units of measurement for pressure.  
P0 = inches of mercury  
P1 = millimeters of mercury  
P2 = millibars  
P3 = kilopascals
4. Press the push button again to advance through the available units.
5. When you have the code showing for the units of measurement you want, press the toggle switch on the side of the case to the right (auto position). Mystic will then perform a self-test and return to normal operation.

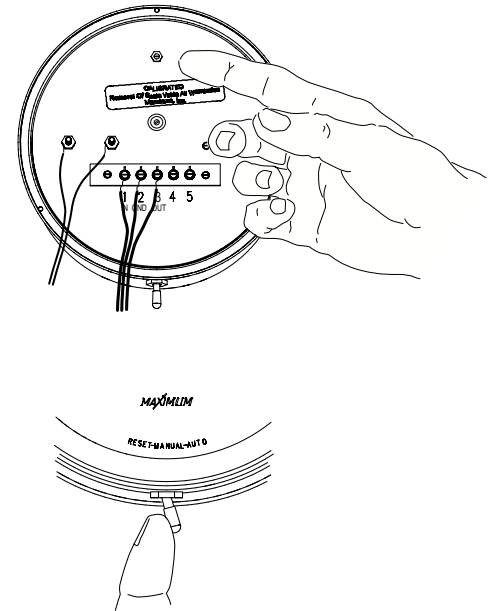

## IMPORTANT FACTS ABOUT YOUR MYSTIC

- **Latch Up-** Power Line disturbances, improper powering up or an error in wiring can cause a blank or improper display reading. If MYSTIC is "latched up" in this way proceed as follows:
  1. Unplug the AC adapter from the 110 VAC outlet.
  2. Wait 15 seconds.
  3. Plug the AC adapter in to the 110 VAC power outlet.
- During long power outages MYSTIC's display will blank out and the instrument will not continue to accumulate data. It will preserve the previously accumulated data for up to 10 years.
- Moving the switch to "Auto" does not erase stored information.
- You do not need to time the 6 second reset time. Mystic will blank out the display to indicate that the memory has been erased.
- Set barometer by obtaining an accurate reading from a source as close to your location as possible. The closest airport, weather bureau or an individual with an accurate barometer would be a few examples.
- Rate-of-Change indicates the measure of the rise or fall of the barometric pressure observed over a one hour period. It is updated every 12 minutes.

*MAXIMUM* INC.

30 Samuel Barnet Boulevard  
New Bedford, MA 02745  
(508) 995-2200

# MYSTIC

## TROUBLESHOOTING

If at any time the temperature reading seems to be giving you difficulty, proceed as follows:

- 1 Remove the instrument from the wall.

At the back of the indicator, disconnect the sensor wires from terminals #4 and #5. The current temperature reading should drop to  $-40^{\circ}\text{F}$  ( $-40^{\circ}\text{C}$ ) or below. This is the normal open circuit reading.

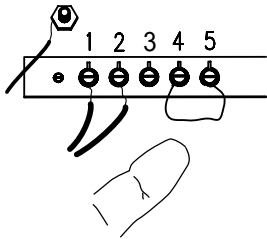
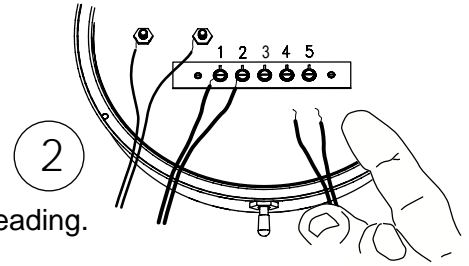

- 3 Use a jumper wire (a paper clip will do) to connect across the sensor terminals #4 and #5. The indicator should read  $122^{\circ}\text{F}$  ( $50^{\circ}\text{C}$ ). If so, disconnect this jumper and proceed to the next step.

Use a jumper to connect between terminals #3 and #4. The calibration test point has been hand-written on the back of the Indicator just above terminals #3 and #4.

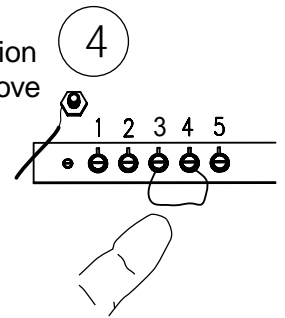

If the indicator is in proper working order, it will read within  $2^{\circ}\text{F}$  of this number. We recommend you mount the instrument back on the wall in this mode for several hours and observe it periodically. This will help detect most intermittent problems. If the indicator registers within  $2^{\circ}\text{F}$  of the test point, the problem is in your sensor or wire.

*MAXIMUM* INC.

30 Samuel Barnet Boulevard  
New Bedford, MA 02745  
(508) 995-2200

# MYSTIC

## INFORMATION FOR THE MERLIN USER

*Warning:* Changes or modifications to this unit not expressly approved by the party responsible for compliance could void the user's authority to operate the equipment.

NOTE: This equipment has been tested and found to comply with the limits for a Class B digital device, pursuant to Part 15 of the FCC Rules. These limits are designed to provide reasonable protection against harmful interference in a residential installation. This equipment generates, uses and can radiate radio frequency energy and, if not installed and used in accordance with the instructions, may cause harmful interference to radio communications. However, there is no guarantee that interference will not occur in a particular installation. If this equipment does cause harmful interference to radio or television reception, which can be determined by turning the equipment off and on, the user is encouraged to try to correct the interference by one or more of the following measures:

- Reorient or relocate the receiving antenna.
- Increase the separation between the equipment and receiver.
- Connect the equipment into an outlet on a circuit different from that to which the receiver is connected.
- Consult the dealer or an experienced radio/TV technician for help.

Shielded cables must be used with the wind sensors to ensure compliance with the Class B FCC limits.

*MAXIMUM* INC.

30 Samuel Barnet Boulevard  
New Bedford, MA 02745  
(508) 995-2200

## IMPORTANT ADDITIONAL INFORMATION

**Components:** Along with the indicator, the following components are included with this instrument:



**Air Temperature  
Sensor w/60' Cable**



**110V AC  
Adaptor**



**3 Brass  
Screws**

**AC Adaptor:** This instrument requires its own AC Adaptor. Due to the various power requirements of each Maximum instrument, attempting to run more than one instrument on a single adaptor could cause improper operation and/or damage to the instrument(s) thereby voiding your 5-year warranty.

**Brass Case:** Your brass case is solid brass A70-30 Holloware quality, with a durable lacquer finish. It is in fact a piece of jewelry and should be treated as such. It should be cleaned at least once a week to keep airborne pollutants (dust, etc...) and any moisture from collecting on the case thereby attacking the lacquer. At no time should you use an abrasive cleaner or cloth on the brass case. Simply use a soft cloth or soft paper towel with a mild glass cleaner to wipe the case clean. If your instruments are in a summer home, and you are not able to clean them regularly, simply lay a small cloth or towel across the top two-thirds so that dust cannot settle on the finish.

**Specifications:** All instrumentation or measuring devices have accuracy tolerances and specifications. Making comparisons between different pieces of equipment is appropriate provided the specified accuracies of both are known.

	<b>Measurement Range</b>	<b>Guaranteed Accuracy</b>
Temperature (Indicator)	-30 to 120°F	±1.5°F
Temperature (Sensor)		±.5°C., 1°F
Barometric Pressure	27.5 – 31.5 Inches of Hg	±0.08 Inches of Hg