

Ice Maker

Instruction Manual

SKU: IM-03D

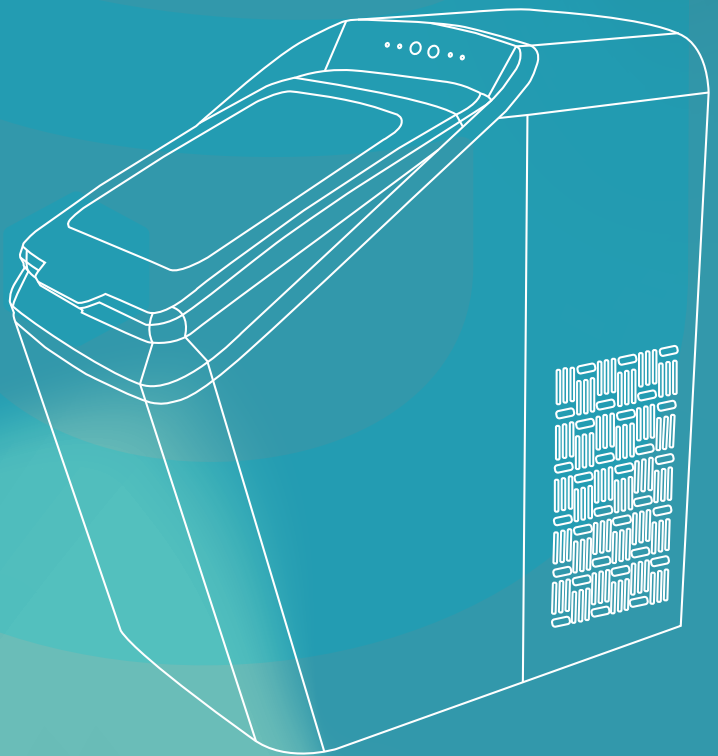

Congratulations

Dear Customer:

we are so lucky to meet you guys!!! Thanks for making a purchase on Euhomy!

We hope to provide you with sincere service. If there is anything missing or wrong with your order, If you have any question about using our Ice Maker. PLEASE reach out to us.

Email: support@euhomy.com

Facebook: @Euhomy

The Euhomy team will answer your doubts online for 24 hours. Your satisfaction is our ultimate goal. We' d appreciate if you could share your experience with other shoppers on Amazon. We' d love to make it right for you! If you just want to see the problem description, you can directly see the tenth page, or contact us directly. Email: support@euhomy.com

If you experience any problems, please send an email to support@euhomy.com.

Our mission:

* To be the most trusted appliance brand, create compact and practical appliance to better your life.

Be sure to register at
www.euhomy.com/register
for updates, warranty, and other relevant information.

I Q&A

1. How often do I need to clean my ice maker?

Depending on whether you use it frequently, it is recommended that you clean it at least once a week. Failure to clean the machine will cause scale accumulation, which will eventually block the pump and cause the product to stop working.

2. How should I clean the machine?

It is recommended to use lemon water or weak acid vinegar for cleaning. Drain immediately after cleaning, and then clean it with pure water.

It is recommended to drain the water at least once every three days. Draining will not only ensure that the hardness of the water is not too high, but also ensure that impurities can be discharged well, and it is not easy to produce scale in the water tank.

3. Why is my ice cube cloudy?

It means that your water quality is turbid. It is recommended to use drinking water or distilled water. If your water quality problem is serious, it is recommended that you install a water filter kit.

4. Can I put milk and juice into the water tank to make ice cubes?

It is recommended that you do not do that. Our research has found that the high concentration of milk and beverages can easily block the pump and reduce the lifespan of the pump. At the same time, the protein in milk is prone to calcification, which chemically reacts with the PU water pipe inside the machine, which easily breaks it, making the product unable to continue working.

5. Why does my ice cube melt easily?

Because the ice maker is not a refrigerator, it does not have a heat preservation function. The high ambient temperature in summer will accelerate the melting of ice cubes. You can close the lid of the machine to keep the internal temperature. Some customers also put electric fans on the side of the machine to blow away the hot air around, thus solving the problem. However, if you are not using ice cubes for a long time, we recommend removing them from the ice basket and storing them in the refrigerator.

6. Why is my ice so thick and difficult to fall from the ice tray? What should I do?

It may be that your ice making time is set for too long, or it may be that the temperature of your environment is low. You can reduce the time to 0 or -6 by pressing the minus key on the touch panel.

7. Why does the ice cube I made have a plastic smell?

The ice cube itself has no taste. If you feel there is a plastic smell, try to clean the inside of the machine with lemon water, then run a few cycles, and finally rinse with distilled water.

8. Why does the ice cube I made have a plastic smell?

There is a faint sound when the machine is running. Closing the lid can reduce the noise. If the water pump makes noise during use, it is recommended to turn off the machine first, and then turn on the machine after cleaning the filter in the water tank to observe whether the noise disappears.

9. Why is water leaking from my machine?

It may be that the PUA tube inside the machine fell off during transportation. You can remove the back cover of the machine and connect it yourself. If you don't know how to operate, please contact the Euhomy team. We will send you a professional video to help you solve the problem.

10. Why is there water flowing but not making ice?

If you make sure that the ambient temperature is not abnormal, then the refrigerant of the machine has leaked. Please provide a video or picture and send it to us, and the Euhomy team will help you.

Contents

Safety precautions	02-03
Operation & Installation	04-07
Tips & Maintenance	08
TECHNICAL PARAMETERS	09
Warranty	10
Troubleshooting-support@euhomy.com	11

I Safety Precautions

IMPORTANT SAFETY TIPS



To reduce the risk of fire, explosion, electric shock, or injury when using your ice maker, follow these important safety instructions:

- Before using, check that the voltage power corresponds to the one shown on the appliance nameplate.
- Do not remove any safety, warning, or product information labels from your ice maker.
- Plug the ice maker into an exclusive grounded outlet. No other appliance should be plugged into the same outlet. Be sure that the plug is fully inserted into the receptacle.
- This appliance must be grounded. It is equipped with a cord having a grounding plug. The plug must be plugged into an outlet that is properly installed and grounded.
- 5. Avoid the use of an extension cord because it may overheat and cause a risk of fire. However, if it is necessary to use an extension cord:
 - (a) Use only extension cords with a grounding plug.
 - (b) The marked rating of an extension cord must be equal to or greater than the rating of this appliance.
 - (c) It should be positioned in such a way that it does not drape over the counter or tabletop where it can be pulled on by children intentionally.
- Do not operate any appliance with a damage cord or plug or after the appliance has malfunctioned or been damaged in any manner. Return the appliance to the nearest authorized service facility for examination, repair or adjustment.
- Do not let the cord hang over edge of table or counter.
- Do not place on or near a hot gas or electric burner, or in a heated oven.
- Place power cord in such a way that it cannot be pulled on by children or cause a tripping hazard.
- Place power cord in such a way that it is not in contact with hot surfaces.
- The use of attachment is not recommended by manufacturer as it may cause fire, electric shock or injury.
- Do not touch the ice-making parts when using the ice maker or making ice to avoid getting frostbite.
- Do not immerse any part of the product in water.
- To disconnect, turn any control to OFF, and then remove plug from wall outlet.
- Do not plug or unplug product with wet hands.
- Unplug the product before cleaning, maintaining and when not in use.
- Do not use with water that is microbiologically unsafe or of unknown quality.
- Do not clean your ice maker with any flammable fluids. The fumes may create a fire hazard or explosion.
- Do not overturn the ice maker. If the ice maker is overturned accidentally, allow it to stand upright for 2 hours before power it on again.
- If the ice maker is brought in from outside in wintertime, do not use for a few hours, allowing the unit to warm up to the room temperature before operating.
- Never put flammable, explosive and corrosive articles into the ice maker.
- Never use the ice maker when there is flammable gas leakage.
- Never store or use gas and other flammable articles near the ice maker to avoid any fire.
- Unplug the ice maker before moving it to avoid damaging the refrigerating system.
- Do not attempt to disassemble, repair, modify, or replace any part of your product.
- This appliance is not intended for use by persons (including children) with reduced physical, sensory or mental capabilities, or lack of experience and knowledge, unless they are under supervision or have been given instructions concerning use of the appliances by a person responsible for their safety.
- Children should be supervised to ensure that they do not play with the appliance.
- Close supervision is necessary when any appliance is used by or near children.
- Do not leave the appliance unattended while in use.
- Do not use outdoors.
- Do not use the appliance for anything else than intended use.
- Please abandon the ice maker according to local regulations as it uses flammable blowing gas and refrigerant.

Safety Precautions

IMPORTANT SAFETY TIPS



When using electrical appliances, all basic safety precautions should be followed to reduce the risk of fire, electric shock, and injury to persons or property. Read all instructions before using any appliance.

- Do not attempt to disassemble, repair, modify, or replace any part of your product
- This appliance can be used by children aged from 10 years and above and persons with reduced physical, sensory or mental capabilities or lack of experience and knowledge if they are under supervision or have been given instructions concerning use of the appliance in a safe way and understand the hazards involved.
- Children shall not play with the appliance.
- Cleaning and user maintenance shall not be made by children without supervision.
- Close supervision is necessary when any appliance is used by or near children.
- Do not leave the appliance unattended while in use.
- Do not use outdoors.
- Do not use the appliance for other than intended use.
- Please abandon the ice maker according to local regulators as it uses flammable blowing gas and refrigerant
- Please according to local regulations regarding disposal of the appliance for its flammable refrigerant and blowing gas.

Risk Of Fire or Explosion- Flammable Refrigerant Used

- Do Not Use Mechanical Devices To Defrost Ice Maker. Do Not Puncture Refrigerant Tubing. To Be Repaired Only By Trained Service Personnel. Do Not Puncture Refrigerant Tubing
- Consult Repair Manual/Owner's Guide Before Attempting To Install or Service This Product. All Safety Precautions Must be Followed.
- Dispose Of Property In Accordance With Federal Or Local Regulations.
- Follow Handling Instructions Carefully.
- The ice maker should be installed in accordance with the safety standard for Refrigeration Systems, ASHRAE15. The ice maker shall not be installed in corridors or hallways of public buildings.
- If the unit is with problem need to be maintained, that replacing with like components and that servicing shall be done by factory authorized service personnel, so as to minimize the risk of possible ignition due to incorrect parts or improper service.



The wires in this mains lead are colored in accordance with the following code Green or Green with a strip

COLOR	WIRING
Yellow	Grounding
White	Neutral
Black	Live

To avoid a hazard due to instability of the appliance , it must be placed at a even or flat surface

I Operation & Installation



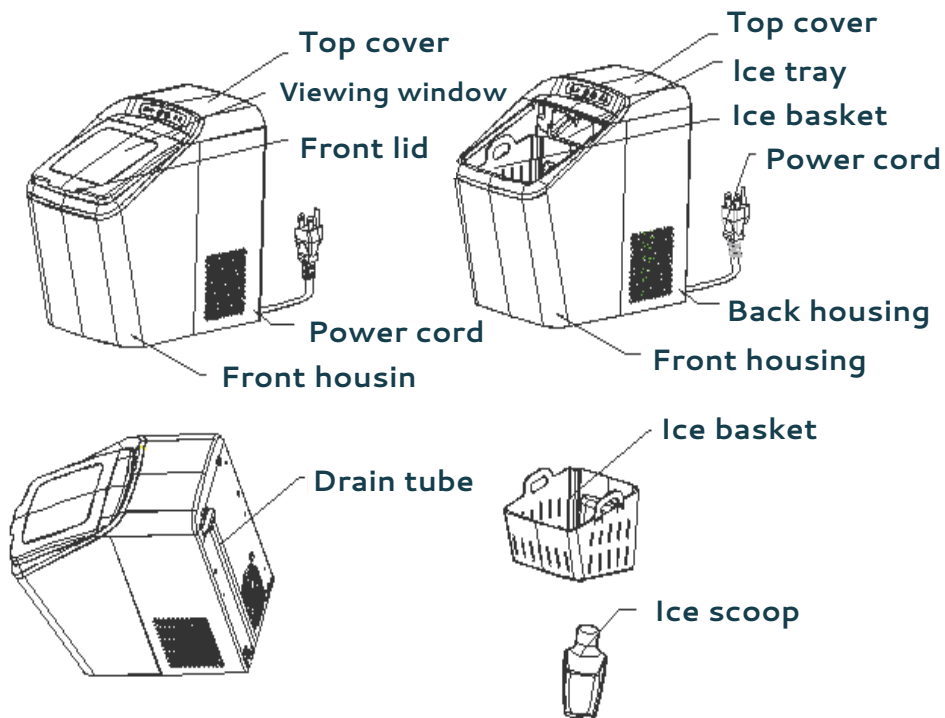



ASSEMBLY AND PARTS

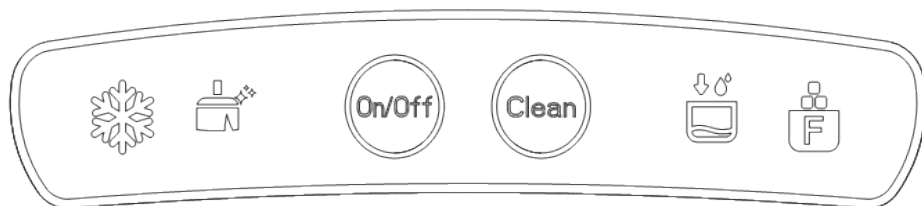

I Operation & Installation

CONTROL PANEL DISPLAY



Key (with indicator)	Function
	The "Ice-making" indicator will light solidly when the appliance is making ice.
	The "Clean" indicator will light solidly when the appliance is performing cleaning.
	Start or stop the appliance.
	"Clean" key.
	Water refill indication. The "No water" indicator will flash when the appliance needs to be refilled. The appliance will be refilled with water automatically if it has a water-refill function.
	Start or stop the appliance.

Operation & Installation

UNPACKING YOUR ICE MAKER

- Remove the exterior and interior packaging. Check that the ice basket and ice scoop are included. If any parts are missing, please contact our customer service.
- Clean the interior with lukewarm water and a soft cloth. Remove the ice basket and clean it.
- Find a place for your ice maker that is protected from direct sunlight and other sources of heat (ie., stove, furnace, radiator). Place the ice maker on a level surface. Make sure that there is at least 6 inches of space between the back and sides of your ice maker and the wall. Allow one hour for the refrigerant fluid to settle before plugging in the ice maker.
- The appliance must be positioned in such a way that the plug is accessible.

Note: Fill with pure water only.

BEFORE FIRST USE

- Unpack the appliance and check to make sure that all the accessories including ice basket and ice scoop etc. are complete. Please contact our client service department if some accessories are missing.
- Please ensure the ice maker is level and on a stable table or platform to avoid malfunction.
- The incline angle of the ice maker cabinet should not exceed 45° during transportation or use. Never turn the ice maker upside down. Doing so could cause the compressor or refrigerating system to operate incorrectly. Please allow time for the fluids in the compressor to settle after the ice maker is moved or transported. Before using the ice maker for the first time, please wait for 2 hours after the unit has been levelled and positioned in the proper place.
- The appliance must be placed on a dry and level surface with sufficient ventilation, far from heat sources such as ovens, heaters and corrosive gases. Leave a 6-inch [15cm] space on all sides of the ice maker for proper ventilation.
- Do not fill the water reservoir with hot water. This may damage the ice maker. It is best to fill the water reservoir with water of room temperature or lower.
- Do not use the appliance at a very cold environment [lower than 41°F/5°C].
- Clean the appliance by following the operation of "CLEANING AND MAINTENANCE" before operating.

Operation & Installation

USING YOUR ICE MAKER

- Ensure that the drain plug at the bottom of water reservoir is closed well.
- Plug the ice maker into the wall outlet the "❄️" indicator blinks.

Note: Please make the ice maker rests for 30 minutes before plugging it in if it has been moved.

- Open the top lid and remove the ice basket.
- **WARNING:** Fill the water reservoir with potable water only.

Note: Do not fill above the MAX water level mark.

- Replace the ice basket and close the top lid.
- Press the "ON/OFF" key and the "❄️" indicator lights solidly.
- The ice-making cycle will last approximately 20–30 minutes, depending on the ambient temperature and water temperature.
- The ice-making assembly is equipped inside of appliance, and the ice-making assembly will keep producing ice when water is being pumped into it. When the ice forms in the ice-making assembly, the ice cubes will be transferred into the ice tray and then the ice cubes will drop into the ice basket. And the above action will be repeated until the ice basket is full.
- The "🔒" indicator will light up when the ice basket is full and then the ice maker will stop the ice-making cycle automatically. Open the front lid and gently remove the ice from the ice basket with the ice scoop. And then replace the ice basket and close the front lid, then the ice maker will restart its ice-making function automatically. If the ice is not removed, after about 8 hours, the appliance will automatically work again, alternatively, you can press "ON/OFF" key to restart the appliance.
- The "💧" indicator will flash when the water reservoir is lack of water.

(a) If the appliance is connected with external water source by the 1/4PE tube shown in the section of "CLEANING AND MAINTENANCE" (see Fig.1), the water reservoir will be refilled with water automatically and the appliance will restart the ice-making cycle; alternatively, the user can remove the ice basket and refill the water reservoir with water to "MAX" mark manually, and then the appliance will restart the ice-making cycle automatically. Please remember to close the front lid after refilling water manually avoid overflow.

(b) If the appliance is not connected with external water source, firstly remove the ice basket and then manually fill the water reservoir with water. After the water reservoir is refilled with water, please close the front lid, and then the appliance will restart the ice-making cycle automatically.

- When you have got your desired amount of ice, stop the ice-making cycle by pressing the "ON/ OFF" key and unplug the unit from the wall outlet.
- Open the front lid and transfer the ice to a freezer.
- Allow the ice maker to reach room temperature.
- Suggest replacing the water every week. Please empty the water reservoir if the ice maker has not been used for a long time.
- The ice maker can be connected with external water source by the 1/4PE tube shown in the section of "CLEANING AND MAINTENANCE" if you want to add the function of refilling water automatically.

I Tips & Maintenance

CLEANING AND MAINTAINING YOUR ICE MAKER

Before using your ice maker, it is strongly recommended to clean it thoroughly.

- Remove the ice basket, add water and detergent into the water reservoir, then hold and press "Clean" key for about 3 seconds, the "🧼" indicator lights up and the appliance enters into the cleaning mode.
- After cleaning for 8 minutes, the appliance stops working and the "❄️" indicator flashes.
- Remove the drain tube at the back of the appliance and place it at the dirty water outlet. Open the drain plug, and then the dirty water will be drained from the drain tube until all the water inside the appliance is drained out.
- Close the drain plug and fill the water reservoir with water. And then press "Clean" key again, the "🧼" indicator lights up and the appliance enters into the cleaning mode.
- Repeat step 3 after the detergent inside the appliance is removed.
- Clean the inside of appliance with a piece of soft cloth soaked in warm water and vinegar.
- Rinse the drain tube and place the drain plug at the fixing groove at the back of appliance.
- Wash the ice basket and ice scoop in warm, soapy water. Rinse and dry.
- Clean the exterior of the ice maker with a soft damp cloth. Use a mild dishwashing soap, if necessary.

Note: Do not use organic solvent, boiled water, detergent, strong acid and strong alkali etc. for cleaning.

- Please empty the water reservoir and dry it for storage if the ice maker has not been used for a long time.

Note:

1. Do not use organic solvent, boiled water, detergent, strong acid and strong alkali etc. for cleaning.
2. Please empty the water reservoir and dry it for storage if the ice maker is not used for a long time.

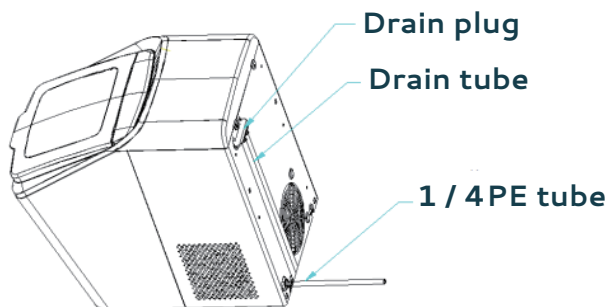

I TECHNICAL PARAMETERS

Model	IM-03D
Protection Type	I
Power	120V AC 60HZ
Ice Making Current	3.0A
Ice Harvest Current	3.0A
Refrigerant	R600a 1.13Oz/32g
Design Pressure(High Side)	200Psig
Design Pressure(Low Side)	103Psig
Net Weight	24LBS
Enclosure	Stainlessl-Blackl





Warranty

Euhomy offers a limited 1-year warranty (“warranty period”) on all of our products purchased new and unused from Euhomy company, with an original proof of purchase and where a defect has arisen, wholly or substantially, as a result of faulty manufacture, parts or workmanship during the warranty period. The warranty does not apply where damage is caused by other factors, including without limitation:

- (a) normal wear and tear;
- (b) abuse, mishandling, accident, or failure to follow operating instructions;
- (c) exposure to liquid or infiltration of foreign particles;
- (d) servicing or modifications of the product other than by Euhomy;
- (e) commercial or non-household use.

The Euhomy warranty covers all costs related to restoring the proven defective product through repair or replacement of any defective part and necessary labor so that it conforms to its original specifications. A replacement product may be provided instead of repairing a defective product. Euhomy’s exclusive obligation under this warranty is limited to such repair or replacement. A receipt indicating the purchase date is required for any claim, so please keep all receipts in a safe place. Although greatly appreciated, the product registration is not required to activate any warranty and product registration does not eliminate the need for the original proof of purchase. The warranty becomes void if attempts at repair are made by non-authorized third parties and/or if spare parts, other than those provided by Euhomy, are used.

You may also arrange for service after the warranty expires at an additional cost. These are our general terms for warranty service, but we always urge our customers to reach out to us with any issue, regardless of warranty terms. If you have an issue with a Euhomy product, please contact us (supportl@euhomy.com), and we will do our best to resolve it for you.

PROBLEM	POSSIBLE CAUSES	SOLUTION
<p>Indicator on</p> 	<ul style="list-style-type: none"> • Be lack of water. • The water screen at the bottom of water reservoir is blocked. • Pump malfunction. <p>There is foreign objects blocked the float of water reservoir.</p> <ul style="list-style-type: none"> • Ice basket is full and the infrared 	<ul style="list-style-type: none"> • Stop making ice, refill water and then press "ON/OFF" key to restart ice-making cycle. • Remove the water screen at the bottom for cleaning. • Send it to the authorized department for repair. • Check the foreign objects and restart the appliance.
<p>Indicator on</p> 	<ul style="list-style-type: none"> • Ice basket is full. • Malfunction of infrared ray. 	<ul style="list-style-type: none"> • Remove the ice from ice basket and then press "ON/OFF" key to restart the ice-making cycle. • The sensor is damaged, please send it to the authorized department for repair.
<p>Lights solidly flashes</p> 	<ul style="list-style-type: none"> • The ice-making assembly is defrosting. 	<ul style="list-style-type: none"> • No need to deal with it, the appliance e will deal with it automatically, and i t will return to normal operation after about 30–45 minutes. Alternatively, you can hold and press the "Clean" key for 3 seconds, and then press the "ON /OFF" key again to restart the appliance after the cleaning procedure is finished.
<p>Indicator flashes</p> 	<ul style="list-style-type: none"> • The ice-making assembly is frozen. 	<ul style="list-style-type: none"> • No need to deal with it. Under this condition, let the appliance be defrosted automatically for about 20 minutes, at that time, the press keys cannot be operated. The appliance can be used again after the defrosting is finished. If this problem occurs repeatedly, it can be considered as refrigerant leakage. Please send the appliance to the authorized department for maintenance.
<p>Poor ice-making result. The ice-making process is normal but the ice produced is broken, which lasts for more than 2 hours.</p>	<ul style="list-style-type: none"> • The ice-making assembly is frozen. 	<ul style="list-style-type: none"> • No need to deal with it. Under this condition, let the appliance be defrosted automatically for about 20 minutes, at that time, the press keys cannot be operated. The appliance can be used again after the defrosting is finished. If this problem occurs repeatedly, it can be considered as refrigerant leakage. Please send the appliance to the authorized department for maintenance.

EUHOMY

Refresh Every Moment!



Email: support@euhomy.com



Facebook: [@Euhomy.Official](https://www.facebook.com/Euhomy.Official)