

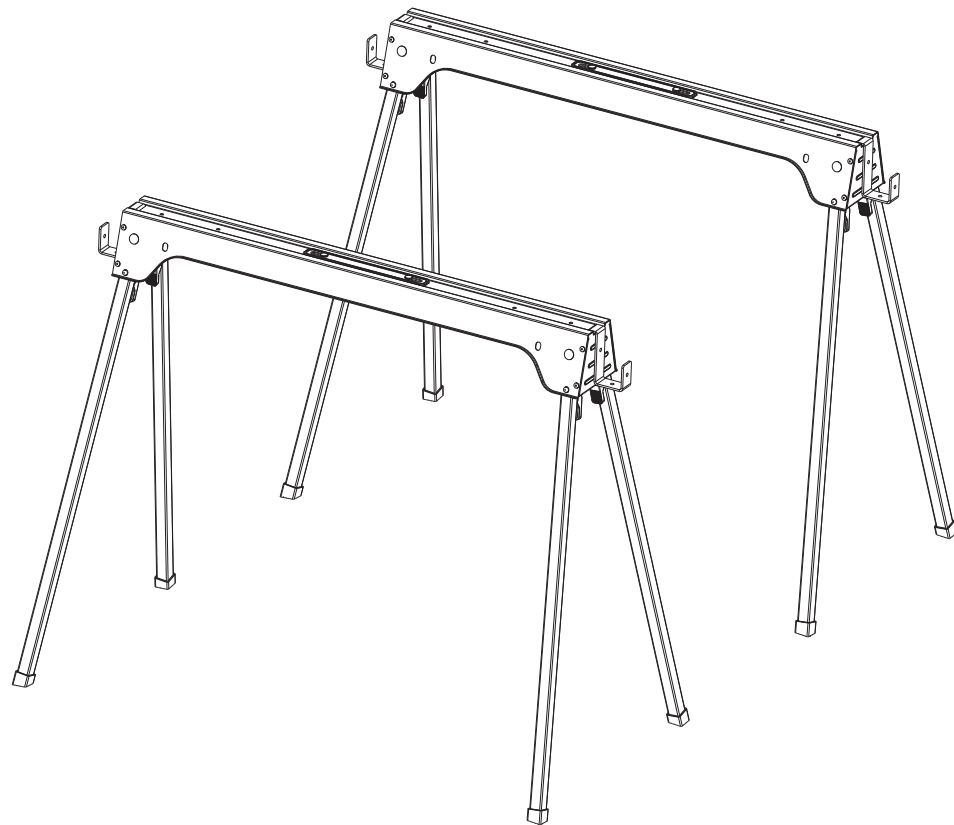

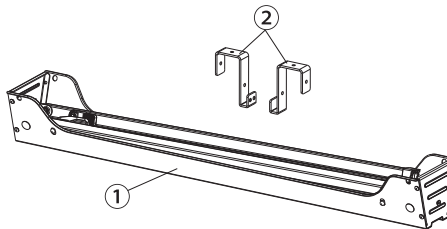
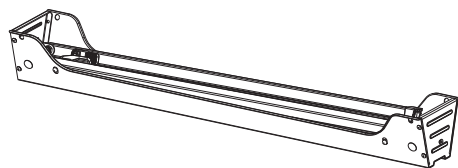
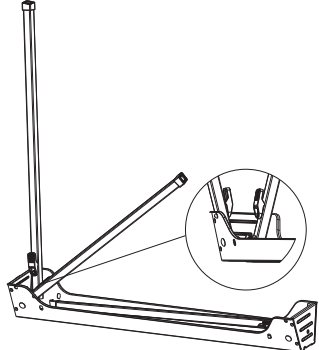

size:14.5x21cm

EXCEL

SAW HORSE (TWIN PACK)

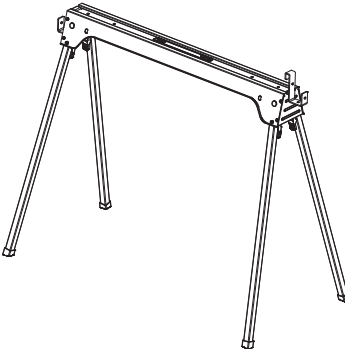

<p>1</p> 	<p>2</p> 
<p>1. Components 1-Sawhorse 2-2pcs Support arms</p>	<p>2. Place the sawhorse on a flat surface with the folded legs facing up.</p>
<p>3</p> 	<p>4</p> 
<p>3. Depress the release lever and rotate the leg until it clicks and locks into the open position. Repeat for each leg.</p>	<p>4. Place the sawhorse in the upright position on a flat surface.</p>
<p>5</p> 	<p>6</p> 
<p>5. Set up the support arms on the hole at the table edge</p>	<p>6. When paired together with a second unit and properly joined by 45x90mm in support arms, a work table can support up to 1000 lbs.</p>