

# ***EXCEL***

## **Operating Instructions**

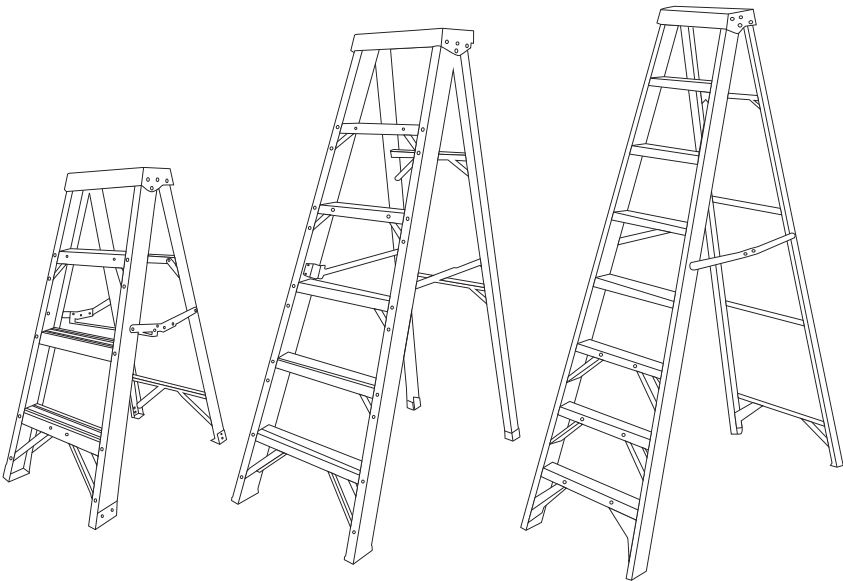

# **HEAVY DUTY ELECTRICIANS FIBREGLASS STEP LADDER**

Please read through this instruction manual carefully before use!

**Exceltools.co.uk**

# Operating & Safety Instructions



Warning!  
Fall from the ladder

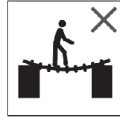

Do not use the ladder as a bridge



Read the instructions



Be aware of electrical hazards when transporting ladder



Maximum total load

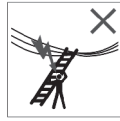

Correct erection angle  
(65°-75°)



Face ladder when ascending or descending ladder



Do not use the ladder on an unlevel or unfirm base



Ensure standing ladder is fully opened before use



Do not overreach



Maximum number of users on ladder



Do not erect ladder on contaminated ground

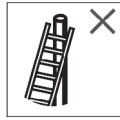

Do not lean the ladder against unsuitable surfaces



Ladders used for access to a higher level shall be extended at least 1m above the landing point and secured, if necessary

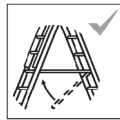

Use the ladder with restraint devices engaged only



Do not step off the side of a ladder

# INTRODUCTION

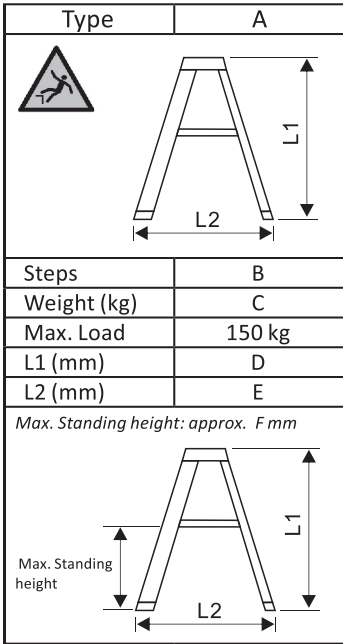

| A    | B | C     | D    | E    | F    |
|------|---|-------|------|------|------|
| 7403 | 2 | 4.2   | 764  | 632  | 253  |
| 1655 | 3 | 5.36  | 1025 | 813  | 253  |
| 6414 | 4 | 6.65  | 1287 | 993  | 514  |
| 1656 | 5 | 7.61  | 1548 | 1173 | 775  |
| 1657 | 7 | 10.10 | 2071 | 1533 | 1298 |

## Professional use



## 1. Check before using the ladder



a) Ensure that you are fit enough to use a ladder. Certain medical conditions or medication, alcohol or drug abuse could make ladder use unsafe;

b) Prevent damage of the ladder when transporting e.g. by fastening and, ensure they are suitably placed to prevent damage;



c) Inspect the ladder after delivery. Before every use visually check the ladder is not damaged and is safe to use. Do not use a damaged ladder.

d) Visually check the ladder at the start of each working day when the ladder is to be used;

e) For professional users regular periodic inspection is required;

f) Ensure the ladder is suitable for the task;

g) Do not use a damaged ladder;

h) Do not use the ladder if contaminated, e.g. with wet paint, mud, oil or snow;

i) For professional use a risk assessment shall be carried out respecting the legislation in the country of use.

j) Do not modify the ladder design.

## 2. Positioning and erecting the ladder

a) Locking devices, if fitted, shall be fully secured before use;

b) The ladder shall be on an even, level and unmovable base;

c) The ladder shall never be repositioned from above;

d) When positioning the ladder take into account risk of collision with the ladder e.g. from pedestrians, vehicles or doors; Secure doors (not fire exits) and windows where possible in the work area.

e) Identify any electrical risks in the work area, such as overhead lines or other exposed electrical equipment;



f) The ladder shall be stood on its feet, not the rungs or treads;

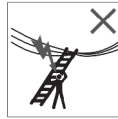

g) Ladders shall not be positioned on slippery surfaces (such as ice, shiny surfaces or significantly contaminated solid surfaces) unless additional effective measures are taken to prevent the ladder slipping or ensuring contaminated surfaces are sufficiently clean.

h) Ladder shall never be moved from the top.

## 3. Using the ladder

a) Do not exceed the maximum permissible load for the type of ladder;

b) Do not overreach; users should keep their belt buckle (navel) inside the stiles and both feet on the same step/rung throughout the task;

c) Do not use standing ladders for access to another level;

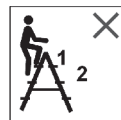

d) Do not stand on the top two steps/rungs of a standing ladder without a platform and hand/knee rail.

e) Ladders should only be used for light work of short duration;

f) Use non-conductive ladders for unavoidable live electrical work;

g) Do not use the ladder outside in adverse weather conditions, such as strong wind;

h) Take precautions against children playing on the ladder;

i) Secure doors (not fire exits) and windows where possible in the work area;



j) Do not ascend or descend unless you are facing the ladder;



k) Keep a secure grip on the ladder when ascending and descending; Maintain a handhold whilst working from a ladder or take additional safety precautions if you cannot.



l) Do not use the ladder as a bridge;



m) Do not wear unsuitable footwear when climbing a ladder;

n) Avoid excessive side loadings e.g. drilling brick and concrete;

o) Do not spend long periods on a ladder without regular breaks (tiredness is a risk);



p) Do not carry equipment which is heavy or difficult to handle while using a ladder.



q) Avoid work that imposes a sideways load on ladders, such as side-on drilling through solid materials (e.g. brick or concrete);

r) Maintain a handhold whilst working from a ladder or take additional safety precaution if you cannot;



s) Standing ladders shall not be used as leaning ladders unless they are designed for that purpose.

t) Do not move a ladder while standing on it.

u) For outdoor use caution to the wind.



v) Only use the ladder in the direction as indicated, only if necessary due to design of ladder.



w) Any horizontal surface which looks like a platform on a standing ladder that is not designed for standing on (e.g. a plastic work tray) shall be clearly indicated on that surface, only if necessary due to design of ladder. The rated load of plastic work tray is 8kg.

#### 4.Repair, maintenance and storage

Repairs and maintenance shall be carried out by a competent person and be in accordance with the producer's instruction.

For repair and replacement of parts, e.g. feet, if necessary contact the producer or distributor.

Ladders should be stored in accordance with the producer's instructions.

Ladders made of or using thermoplastic, thermosetting plastic and reinforced plastic materials should be stored out of direct sunlight.

Ladders made of wood should be stored in a dry place and shall not be coated with opaque and vapour-tight paints.

The important considerations when storing a ladder (not in use) should include the following:

-Is the ladder stored away from areas where its condition could deteriorate more rapidly (e.g. dampness, excessive heat, or exposed to the elements)?

-Is the ladder stored in a position which helps it to remain straight (e.g. hung by the stiles on proper ladder brackets or laid on a flat clutter free surface)?

-Is the ladder stored where it cannot be damaged by vehicles, heavy objects, or contaminants?

-Is the ladder stored where it cannot cause a trip hazard or an obstruction?

-Is the ladder stored securely where it cannot be easily used for criminal purposes?

-If the ladder is permanently positioned (e.g. on scaffolding), is it secured against unauthorized climbing (e.g. by children)?

## **MAINTENANCE AND STORING YOUR LADDER:**

- Keep the ladder in a clean, dry place.
- Hold the ladder firmly when carrying it.
- Never store materials on your ladder.
- Keep your ladder clean and free from any foreign matter.
- Clean the ladder after each use.  
Regularly check the parts and hinges of the ladder. Oil the hinges regularly, but do so carefully to ensure no oil drips on the rungs or side rails.

For regular inspection, the following items shall be taken into account:

— check that the stiles/legs (uprights) are not bent, bowed, twisted, dented, cracked, corroded or rotten;

— check that the stiles/legs around the fixing points for other components are in good condition;

— check that fixings (usually rivets, screws or bolts) are not missing, loose, or corroded;

— check that rungs/steps are not missing, loose, excessively worn, corroded or damaged;

— check that the hinges between front and rear sections are not damaged, loose or corroded;

— check that the locking stays horizontal, back rails and corner braces are not missing, bent, loose, corroded or damaged;

— check that the rung hooks are not missing, damaged, loose or corroded and engage properly on the rungs;

— check that guide brackets are not missing, damaged, loose or corroded and engage properly on the mating stile;

— check that ladder feet / end caps are not missing, loose, excessively worn, corroded or damaged;

— check that the entire ladder is free from contaminants (e.g. dirt, mud, paint, oil or grease);

— check that locking catches (if fitted) are not damaged or corroded and function correctly;

— check that the platform (if fitted) has no missing parts or fixings and is not damaged or corroded.

If any of the above checks cannot be fully satisfied, you should NOT use the ladder.

For special ladder types, further items identified by the manufacturer shall be taken into account.

## **Reasons for accidents**

The following list of hazards and examples of their causes, which is not exhaustive, are common reasons for accidents encountered when using ladders and are the basis on which the information in this manual has been developed:

### **a) Loss of stability:**

- 1) Incorrect positioning of the ladder (such as incorrect angle for leaning ladder or not fully opening a standing ladder);
- 2) slide outwards at the bottom (such as bottom of leaning ladders sliding away from the wall)
- 3) side slip, falling sideways and top flip (such as overreaching or fragile top contact surface);
- 4) falling sideways
- 5) condition of the ladder (such as missing anti-slip feet);

- 6) stepping off an unsecured ladder at height;
- 7) ground conditions (such as unstable soft ground, sloping ground, slippery surfaces or contaminated solid surfaces);
- 8) adverse weather conditions (such as windy conditions);
- 9) collision with the ladder (such as vehicle or door);
- 10) incorrect choice of ladder (such as too short, unsuitable task).

**b) From handling:**

- 1) Transferring the ladder to the work position;
- 2) erecting and dismantling the ladder;
- 3) carrying items up the ladder.

**c) Slip trip and fall of user:**

- 1) Inappropriate footwear;
- 2) contaminated rungs or Steps;
- 3) unsafe user practices (such as climbing 2 rungs at a time, sliding down stiles).
- 4) ground conditions (such as unstable soft ground, sloping ground, slippery surfaces or contaminated solid surfaces).

**d) Structural failure of ladder:**

- 1) condition of the ladder (such as damaged stiles);
- 2) overloading the ladder.
- 3) unintended use.

**e) Electrical hazards:**

- 1) Unavoidable live working (e. g. fault finding);

- 2) positioning ladders too close to live electrical equipment (such as overhead power lines);
- 3) ladders damaging electrical equipment (such as covers or protective insulation);
- 4) incorrect selection of type of ladder for electrical work.

For more detailed information  
(e.g. for inspection of items) please contact us.

# ***EXCEL***

---

**CONTACT US:**

**Tools4Trade Ltd.  
6 Fitzhamon Court,  
Bradwell Wolverton,  
Milton Keynes, MK12 6LB**

**PHONE:**

**01908 969966**

**Email:**

**[sales@tools4trade.co.uk](mailto:sales@tools4trade.co.uk)**