

MINI ORBITAL-GENIE™

VARIABLE SPEED BENCHTOP ORBITAL SHAKER

OPERATING INSTRUCTIONS

Models SI-M100 through SI-M106 and SI-M1500 through SI-1706



80 Orville Drive, Ste. 102, Bohemia, NY 11716 U.S.A.
Phone: (631) 567-4700 • Fax: (631) 567-5896 Toll Free: 888-850-6208
Customer Service: custsvc@scientificindustries.com
www.scientificindustries.com

The **MINI ORBITAL-GENIE™** is designed to provide variable speed, multi vessel orbital shaking in a compact, durable and user friendly unit. Models SI-M100 thru SI-M105 have speed ranges of 20-100 RPM. Models SI-M1500 thru SI-M1505, SI-M1600 thru SI-M1605 and SI-M1700 thru SI-M1705 have speed ranges of 35-300 RPM.

OPERATING INSTRUCTIONS

We recommend you retain the original packaging for 90 days in case you need to return the product for any reason to your distributor or Scientific Industries.

Plug the line cord into a properly grounded electrical outlet.

120 VAC for the SI-M100, SI-M1500, SI-M1600 and SI-M1700 models;

220-240 VAC for the SI-M101, SI-M102, SI-M103, SI-M104, SI-M106, SI-M1501, SI-M1502, SI-M1503, SI-M1504, SI-M1506, SI-M1601, SI-M1602, SI-M1603, SI-M1604, SI-M1606, SI-M1701, SI-M1702, SI-M1703, SI-M1704 and SI-M1706 models;

100 VAC for the SI-M105, SI-M1505, SI-M1605 and SI-M1705 models..

The work surface on which the shaker is placed must be level, stable and non-slip.

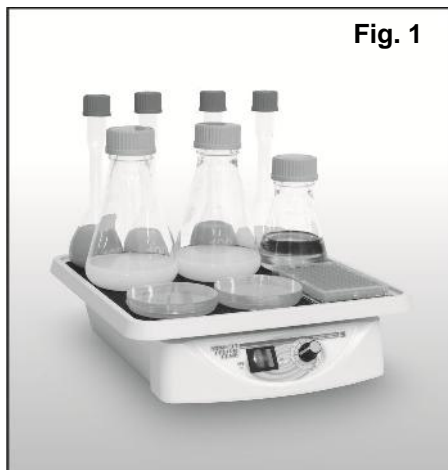

Fig. 1



Fig. 2

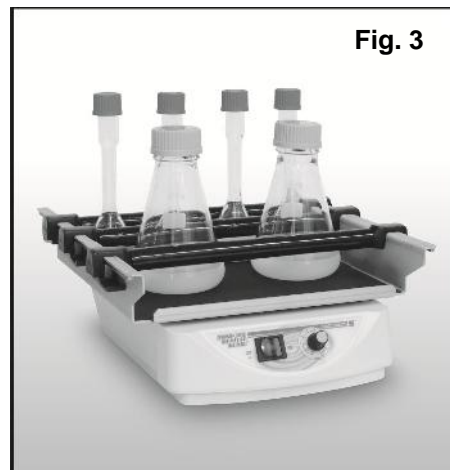

Fig. 3

MINI-100 ORBITAL-GENIE™ with Standard Platform (SI-M100)

The shaker is supplied with a durable thermoplastic platform with an anti-slip rubber mat (Fig.1). The platform has a molded raised edging that contains minor spills and keeps the work surface dry and clean. Place the vessels so that they do not touch each other. Position vessels evenly distributed on the platform. Uneven loading may result in excessive vibrating of the shaker and support table. Should this occur, reduce the speed or turn the shaker off and redistribute the vessels. The platform can accommodate up to 2 liter vessels with a 5 lbs load capacity. Stacking trays are available that increase the capacity of vessels that can be utilized (Fig.2). These trays also have an anti-slip rubber mat and raised molded edge.

MINI-300 ORBITAL-GENIE™ with Universal Ratcheting Clamps (SI-M1500)

The shaker is supplied with two ratcheting cushioned clamps (Fig.3) Position the two ratcheting clamps on the platform with sufficient space to fit the vessels. It is very important to regularly monitor shaking cycles to ensure that the vessels remain firmly secure. Press the ratcheting clamps until the foam is compressed against the vessels (Fig.7). To release the ratcheting clamps, press the release arm and slide away (Fig.8).

MINI-300 ORBITAL-GENIE™ with Standard Flask Clamps (SI-M1600)

The shaker is supplied with a platform for accepting various size flasks or beakers (Fig.4). Flask clamps attach to the platform with captive mounting screws. Flask clamps are sold separately. Position clamps evenly distributed on the platform. Uneven loading may result in excessive vibrating of the shaker and support table. Should this occur, reduce the mixing speed or turn the shaker off and redistribute the load of the vessels.

MINI-300 ORBITAL-GENIE™ with Adhering Mat (SI-M1700)

The shaker is supplied with an adhering rubber mat for use with bottles and dishes that cannot be held with conventional clamps (Fig.5). Patented material is naturally adhering. Rinse the rubber clean to renew adhering properties. Flasks clamps can be used on this unit by removing the adhering mat (Fig.6).

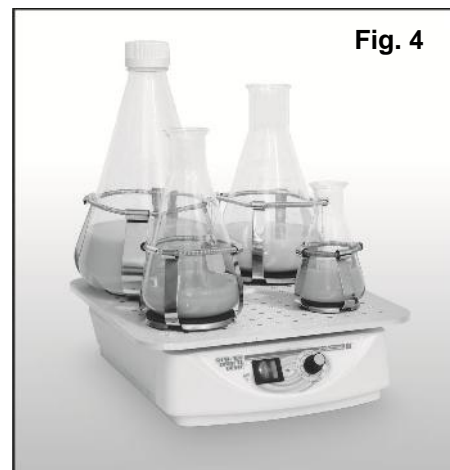

Fig. 4



Fig. 6

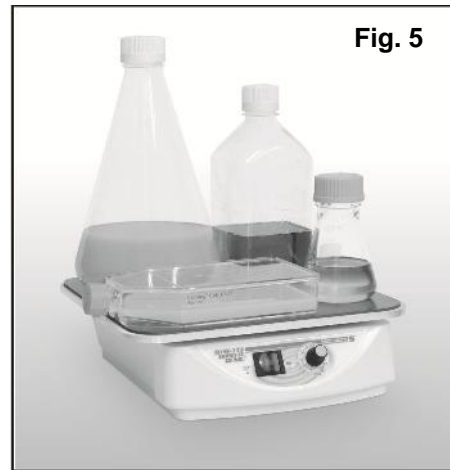

Fig. 5

OPERATION

Power ON the **MINI ORBITAL-GENIE™** (rocker switch on front of housing). Select the speed by turning the speed control knob until the desired speed is attained.

SPECIFICATIONS

The **MINI ORBITAL-GENIE™** is classified as "Installation Category 2", "Overvoltage Category 2" and "Pollution Degree 2".
 Environmental: 0°C - 38°C (32°F-100°F), 95% Humidity max. Indoor use only in elevation up to 2000m of altitude.

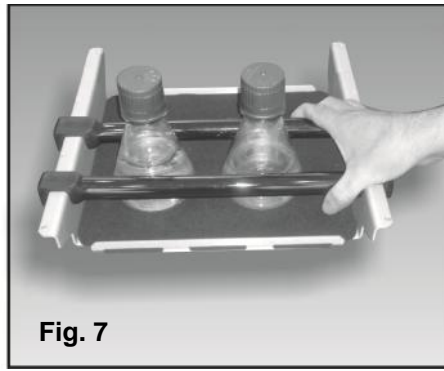

Fig. 7

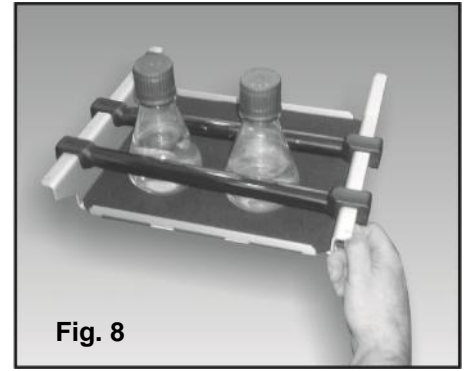

Fig. 8

SI-M100		60HZ	0.50A	SI-M104		1.0	0.25A
SI-M1500		60HZ	0.50A	SI-M1504		1.0	0.25A
SI-M1600		60HZ	0.50A	SI-M1604		1.0	0.25A
SI-M1700		60HZ	0.50A	SI-M1704		1.0	0.25A
SI-M101		50HZ	0.25A	SI-M106		1.0	0.25A
SI-M1501		50HZ	0.25A	SI-M1506		1.0	0.25A
SI-M1601		50HZ	0.25A	SI-M1606		1.0	0.25A
SI-M1701		50HZ	0.25A	SI-M1706		1.0	0.25A
SI-M102		50HZ	0.25A	SI-M105		50/60HZ	0.50A
SI-M1502		50HZ	0.25A	SI-M1505		50/60HZ	0.50A
SI-M1602		50HZ	0.25A	SI-M1605		50/60HZ	0.50A
SI-M1702		50HZ	0.25A	SI-M1705		50/60HZ	0.50A
SI-M103		50HZ	0.25A				
SI-1503		50HZ	0.25A				
SI-1603		50HZ	0.25A				
SI-1703		50HZ	0.25A				

MINI-100 ORBITAL-GENIE™

Weight: 3.5 Kg (7.8 lbs)
 Dimensions: (DxW) 350 x 350mm, (14 x 14in)
 Orbit: 19mm diameter

MINI-300 ORBITAL-GENIE™

Weight: 10.25 Kg (22.6 lbs)
 Dimensions M1500: (DxW) 350 x 350mm, (14 x 14in)
 Dimensions M1600 & M1700: (DxW) 330 x 330mm, (13 x 13in)
 Orbit: 19mm diameter

- CAUTION! Do not lift your **MINI ORBITAL-GENIE™** Shaker by the clamping platform.
- CAUTION! If this equipment is used in a manner not specified by the manufacturer, the protection provided by the equipment may be impaired.
- CAUTION! Unplug from power before cleaning. Do not immerse.
- CAUTION! Do not position the equipment so that it is difficult to disconnect the power cord.
- CAUTION! This equipment has been tested and found to comply with the limits for a Class A digital device, pursuant to Part 15 of the FCC Rules. These limits are designed to provide reasonable protection against harmful interference when the equipment is operated in a commercial environment. This equipment generates, uses, and can radiate radio frequency energy and, if not installed and used in accordance with the instruction manual, may cause harmful interference to radio communications. Operation of this equipment in a residential area is likely to cause harmful interference in which case the user will be required to correct the interference at his own expense.

Care and Handling

Your **MINI ORBITAL-GENIE™** should be given the care normally required for any electrical appliance. Unplug unit and wipe housing with damp cloth and detergent. Blot any spills immediately.

Parts Assembly List

To order parts for the MINI ORBITAL GENIE™ Shaker:

Contact your local distributor or visit www.scientificindustries.com. Please specify Part No., quantity and electric voltage.

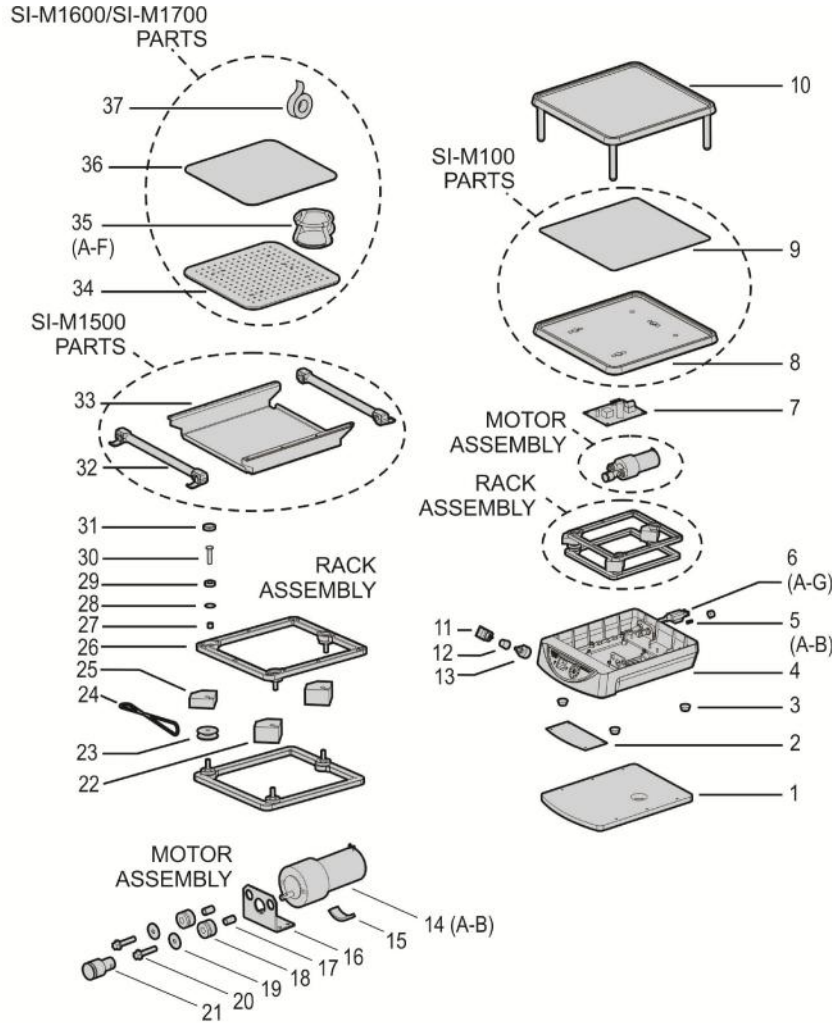

Item No.	Part No.	Description	Item No.	Part No.	Description
1	0M-M1500-200	External Weight	18	HWP0135	Grommet
2	0M-M100-208	Cover	19	WAP0051	Fender Washer
3	HWP0133	Feet	20	SCP0130	Cap Screw
4	Enclosure	PP-M100-400	21	0M-M100-204	Pulley motor
5A	EFP0001	5 x 20mm 'F' Fuse .50 amp	22	0M-M100-202	Offset Idler
5B	EFP0002	5 x 20mm 'F' Fuse .25 amp	23	0M-M100-209	Drive Pulley
6A	318-0510-02	120V Line Cord	24	0M-M100-203	Belt
6B	OK-0246-901	230V Line Cord, No Plug	25	0M-M100-201	Offset Drive
6C	OK-0256-901	230V Line Cord, Euro Plug	26	PP-M100-401	Bearing Cage
6D	OK-0266-901	230V Line Cord, British Plug	27	HWP0131	Spacer, Bearing
6E	OK-0276-901	230V Line Cord, Swiss Plug	28	WAP0050	Washer, Neoprene
6F	OK-0286-901	100V Line Cord	29	BRP0001	Bearing
6G	ECP0021	Australian Plug (only)	30	SCP0105	Screw, Bearing
7	EB-1100-501	Power Supply Board	31	WAP0049	Washer, Nylon
8	PP-M100-402	Top Platform	32	SI-M1510	Universal Ratcheting Clamp
9	0M-M100-200	Rubber Pad	33	0A-M1500-002	Top Platform Assembly
10	SI-M150	Stacking Tray	34	0A-M1600-001	Top Platform/Mask
11A	ESP0001	100, 120V DPST Switch-Red	35A	SI-1610	100mL Flask Clamp
11B	ESP0002	230V DPST Switch-Green	35B	SI-1611	125/150mL Flask Clamp
12	KBP0006	Speed Control Knob	35C	SI-1612	250mL Flask Clamp
13	0A-1100-060	Potentiometer	35D	SI-1613	500 mL Flask Clamp
14A	EM0014	Motor, MINI-100	35E	SI-1614	1 L Flask Clamp
14B	EM0015	Motor, MINI-300	35F	SI-1615	2 L Flask Clamp
15	0M-M100-206	Motor Pad	36	SI-M1617	Adhering Mat
16	0M-M100-207	Motor Bracket	37	SI-1616	Double Sided Adhesive Roll
17	HWP0134	Motor Spacer			