

MULLET®

READY. SET. FLOW.

YOUR 12-STEP DUST RECOVERY PROGRAM

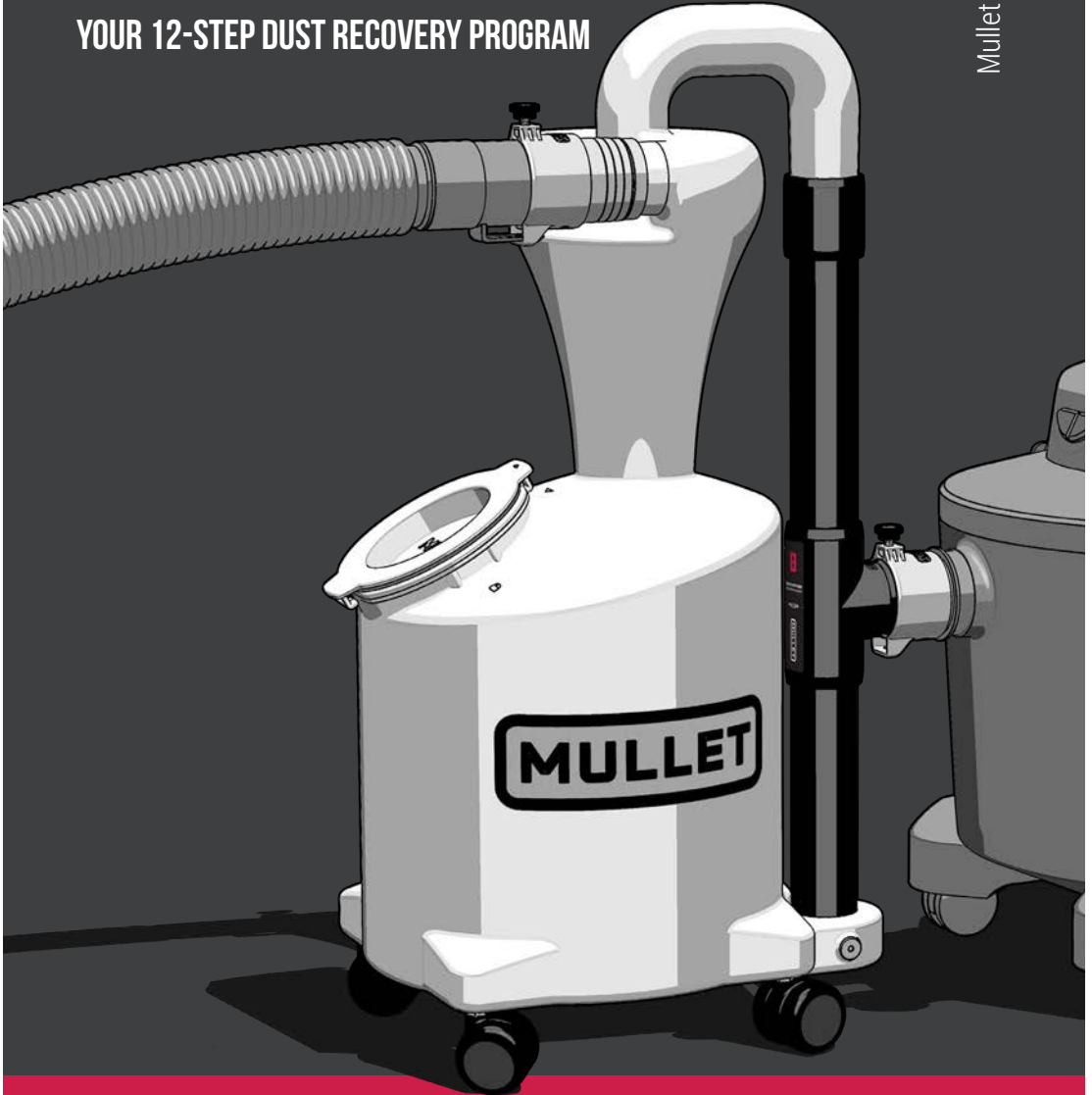

Mullet Cyclonopedia / Owners Guide

M5

The Mullet® High-Speed Cyclone Dust Collector

M5



WARNING

Messes come in all shapes and sizes, and the Mullet® High-Speed Cyclone Dust Collector helps dispose of virtually all of them. But that doesn't mean you should use it in all situations.

Be sure to read and follow all safety instructions below and that of your vacuum before getting started.

- Don't vacuum anything that is hot, burning or smoking, such as cigarettes, matches or hot ashes.
- Never vacuum explosive liquids (e.g., gasoline, paint thinner, etc.), acids or solvents, or operate in areas where flammable or explosive liquids are present.
- Don't vacuum combustible explosive materials, such as coal, grain, or other finely divided combustible material.
- To avoid spontaneous combustion, empty dump bin after each use.
- Don't vacuum hazardous, toxic or carcinogenic materials, such as asbestos or pesticides.
- Observe all warnings and safety instructions from your vacuum, including disconnecting the power source before servicing your Mullet and wearing proper safety equipment while operating.



WARRANTY

We're dedicated to making quality tools that perform day in and day out. But sometimes the unexpected happens. So, if there's an issue with your Mullet Tools product, we provide the below warranty.

LIMITED WARRANTY

The Mullet High-Speed Cyclone Dust Collector is warranted against defects in materials and workmanship for 1 year after the original date of purchase from a Mullet Tools authorized dealer and only applies to non-commercial use by the original owner. Structural alterations and use inconsistent with that outlined in this owners manual would not be covered under this warranty. Additionally, normal wear and tear is not warranted.

The Mullet High-Speed Cyclone Dust Collector must be returned directly to Mullet Tools. For details, reach out to gus@mulletools.com. Mullet Tools will repair or replace, at our discretion, the defective product or part.

There are no express warranties other than the warranty set forth herein. **ANY IMPLIED WARRANTIES, INCLUDING ANY IMPLIED WARRANTIES OF MERCHANTABILITY OR FITNESS FOR ANY PARTICULAR PURPOSE, ARE LIMITED TO THE DURATION OF THIS EXPRESS WARRANTY.** Some States do not allow limitations on how long an implied warranty lasts, so the above limitation may not apply to you.

UNDER NO CIRCUMSTANCES, WHETHER FOR BREACH OF WARRANTY, BREACH OF CONTRACT, NEGLIGENCE, OR OTHER TORT, OR ANY STRICT LIABILITY THEORY, WILL MULLET TOOLS BE LIABLE FOR ANY INCIDENTAL OR CONSEQUENTIAL DAMAGES. Some States do not allow the exclusion or limitation of incidental or consequential damages, so the above limitation or exclusion may not apply to you. This warranty gives you specific legal rights, and you may also have other rights which vary from state to state. The warranty is only available in the United States. No Mullet Tools reseller, agent, or employee is authorized to make any modification, extension, or addition to this warranty.

M5

WHAT YOU GOT

Herein lies the contents of the powerful Mullet High-Speed Cyclone Dust Collector. And some swag, which you should display with pride everywhere legally allowed.



Clear Polycarbonate
Lid & O-ring



Swivel Casters



3 1/2" Bolt



1 1/2" Blind Tee

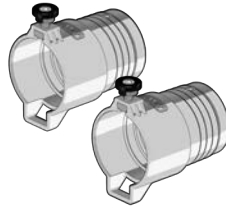

Mullet® Wet Dry Shop
Vacuum Hose Adapters



PVC Cut Sticker

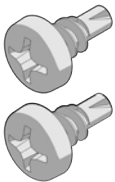

5/16" Self-Drilling Screws

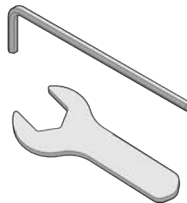

4mm Hex Wrench
14mm Flat Wrench

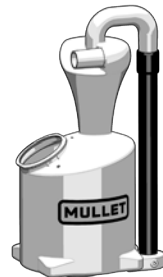

Cyclone and Dump Bin
1 1/2" Coupling
1 1/2" PVC Pipe

ANATOMY

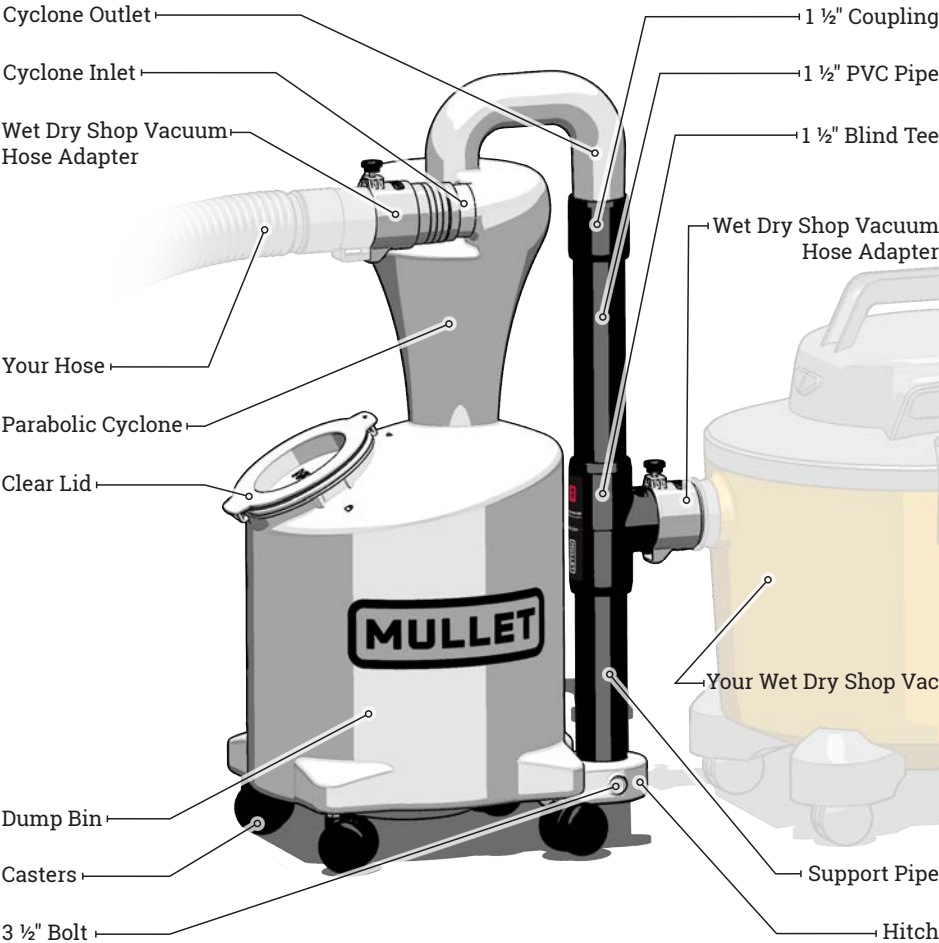

MISSING SOMETHING?

Think we might have shorted you? Our man Gus will get you sorted. gus@mullettools.com



M5

WHAT YOU NEED



TOOLS

- Hack saw (or preferred tool for cleanly cutting PVC)
 - Phillips screwdriver
 - Work bench (instead of floor) to work at eye level
-



TIME: 1 BEER OR 20 MINUTES

And we mean that. Our advice is to follow the instructions, finish early and enjoy those last minutes responsibly.



A VACUUM

Your vac might not exactly resemble the fine illustrations in this guide, but don't fret. The Mullet doesn't discriminate ... we serve all kinds here.

DOES YOUR VAC HAVE AN ANGLED INLET?

In the unlikely case that it does, we have a free 3D printed Hose Adapter to get you hooked up in no time.

Get in touch with gus@mullettools.com.





A LITTLE SPACE

Your Mullet is designed to combine with your wet dry vacuum so that they function and move as a single integrated unit, resulting in a footprint roughly twice the size of your wet dry vacuum alone.

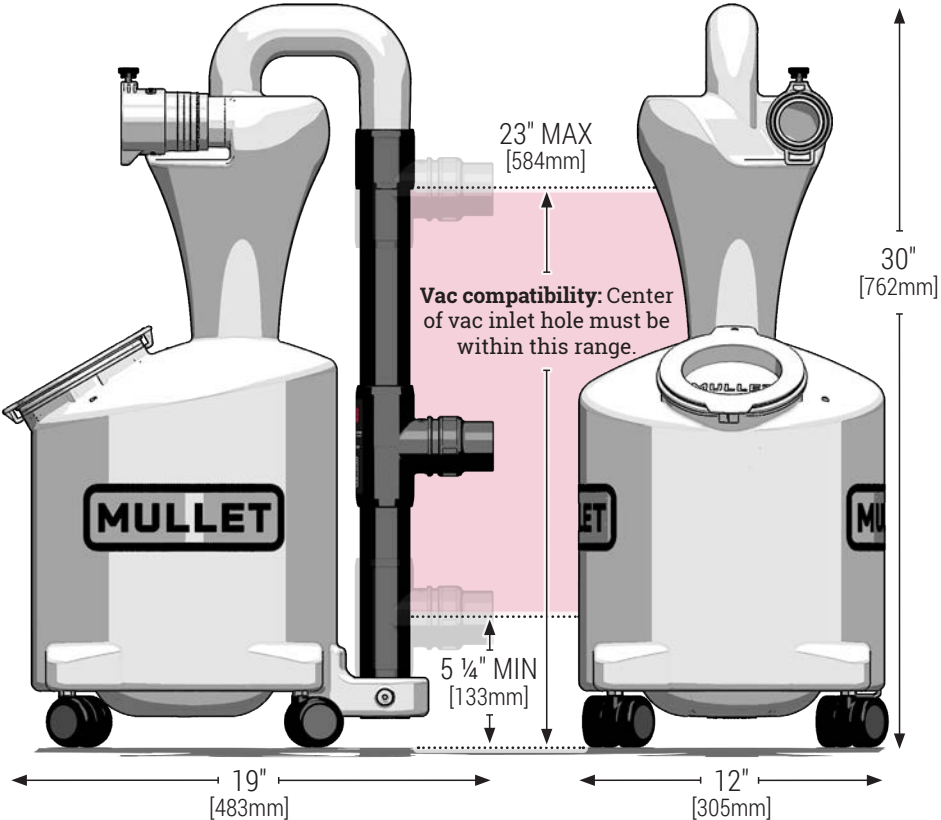

M5

PUT IT TOGETHER

1. MAKE IT MOBILE

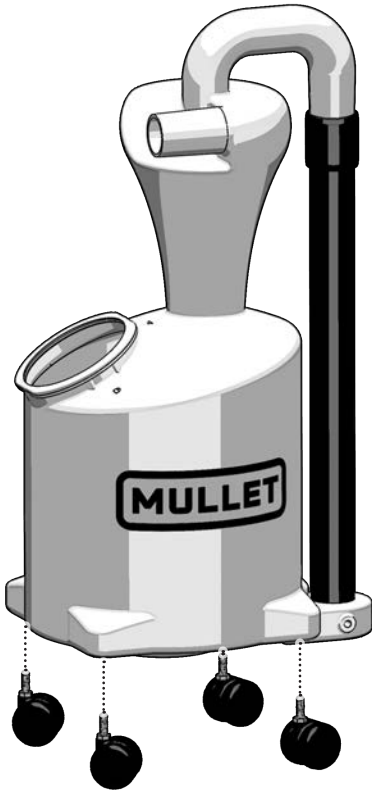

Use included 14mm flat wrench to tighten casters to base. **DO NOT OVERTIGHTEN.**

2. INSTALL LID

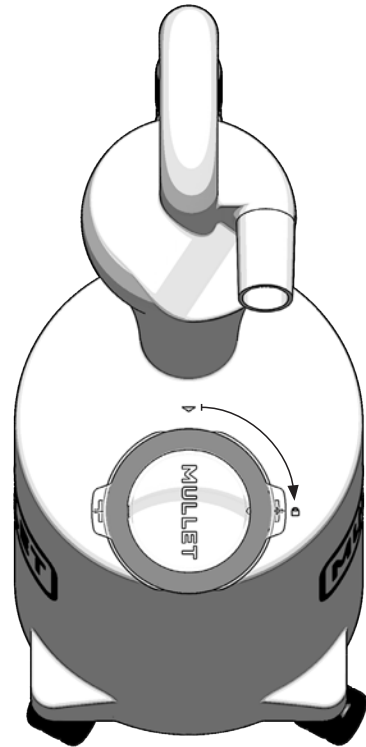

Align clear lid with markings on neck of dump bin. Rotating lid 90 degrees secures it in place for the bumpiest rides.

3. PREP YOUR VAC

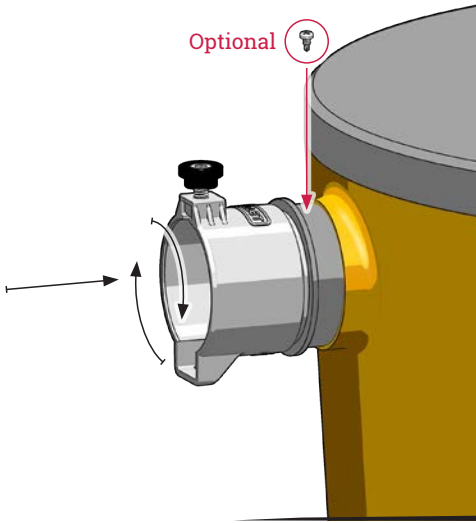

Insert smaller end of either hose adapter into vac inlet and **MAKE SURE IT IS FULLY SEATED**. Twist and push as needed.

Lightly tap with a rubber mallet, if necessary.

If hose adapter remains loose or doesn't fully seat, see Troubleshooting Tip 1.

Optional: Secure hose adapter to vac inlet with included self-drilling screw for a more permanent connection. Hand tighten with a Phillips screwdriver to ensure you don't strip the plastic.

4. TEE IT UP

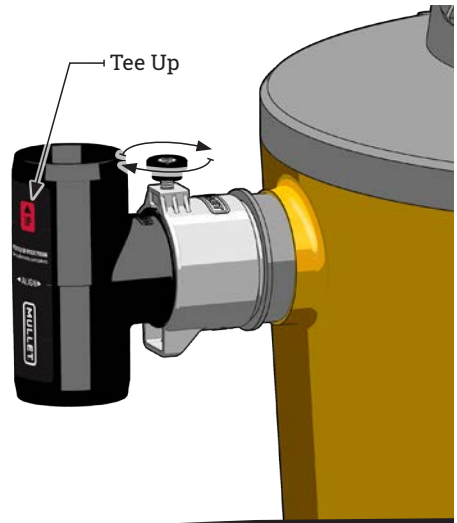

Fully insert tee into hose adapter.

ENSURE ARROW ON TEE IS POINTING UP.

Tighten hose adapter thumb screw onto tee.

DO NOT OVERTIGHTEN.

M5

AND NOW THE FUN PART

5. MARK YOUR CUT

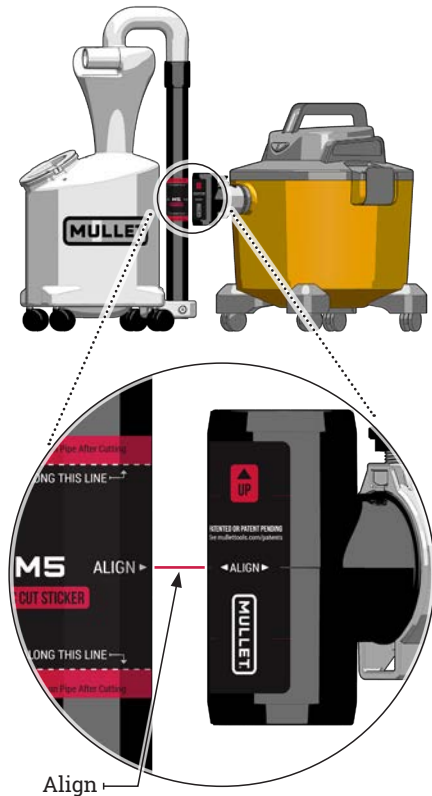

On a flat surface, bring vac up alongside your Mullet. Place PVC cut sticker on pipe so that center marks **ALIGN** on tee and PVC stickers.

6. REMOVE BOLT

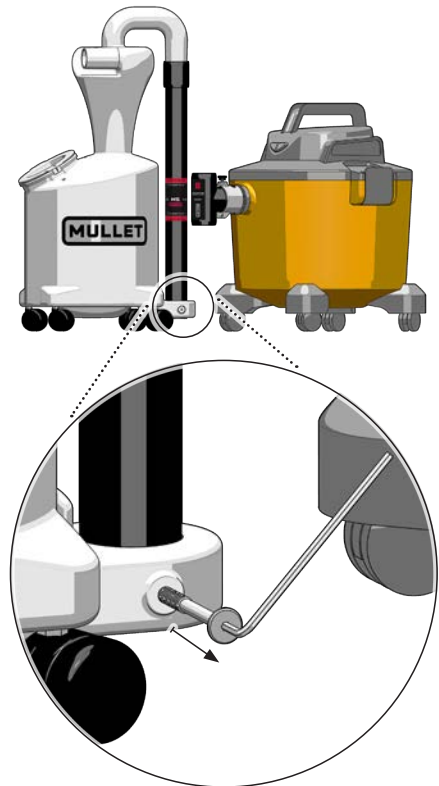

Back out bolt from Mullet hitch using included hex wrench, and remove PVC pipe from your Mullet.

7. CUT PVC PIPE

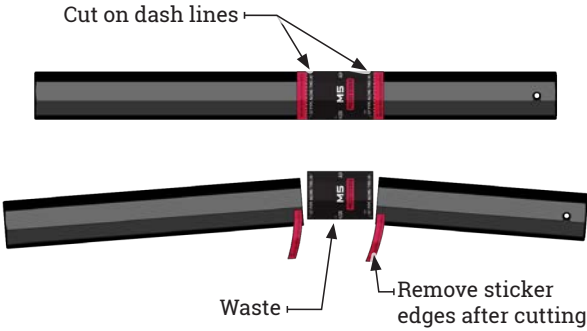

Lay PVC pipe out horizontally and make straight cuts on dash lines of PVC cut sticker. Clean any shavings from pipe.

Remove any sticker left on pipe after cutting.

8. ASSEMBLE PVC PIPE

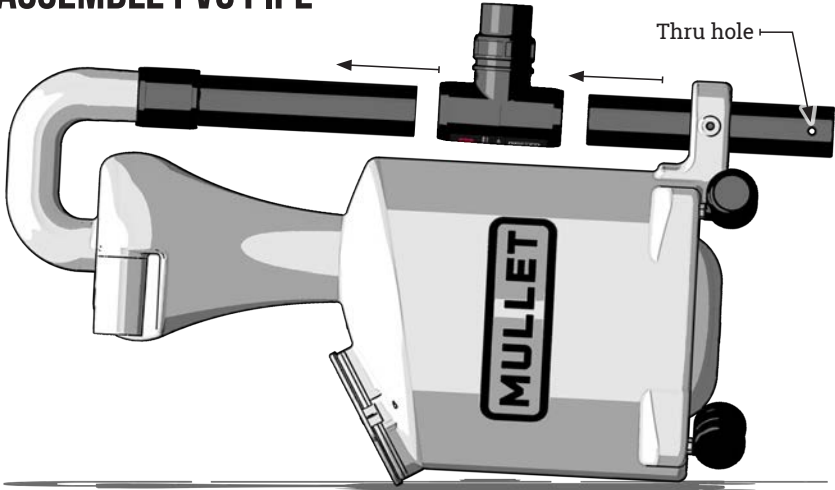

Insert top section of pipe along with tee. Twist and push until pipe is fully seated into coupling and tee. Next, insert support pipe section (with pre-drilled hole) up through hitch on your Mullet and connect to bottom of tee by twisting/pushing together until fully seated.

M5

THE MOMENT OF TRUTH

9. INSTALL BOLT

Insert bolt through hitch and holes in support pipe. Tighten bolt with included hex wrench.

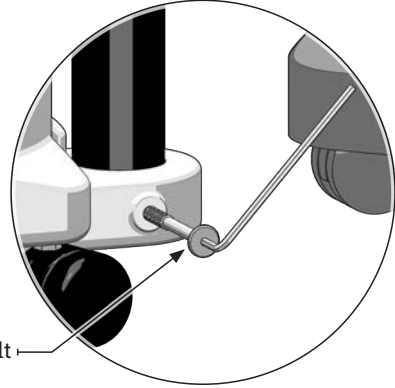

Install 3/2" bolt

10. CHECK FIT



Good to go

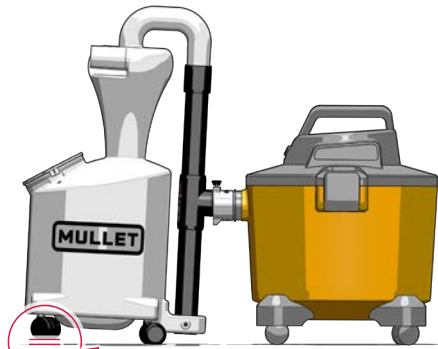

Give it another go

Bring your Mullet and vac together on a flat surface. Insert tee on Mullet into hose adapter on vac. If they don't line up [see Troubleshooting Tip 2](#).

11. CONNECT THEM

Once everything aligns, ensure tee is fully inserted into hose adapter and tighten thumb screw. **AGAIN, HERCULES, DON'T OVERTIGHTEN.**

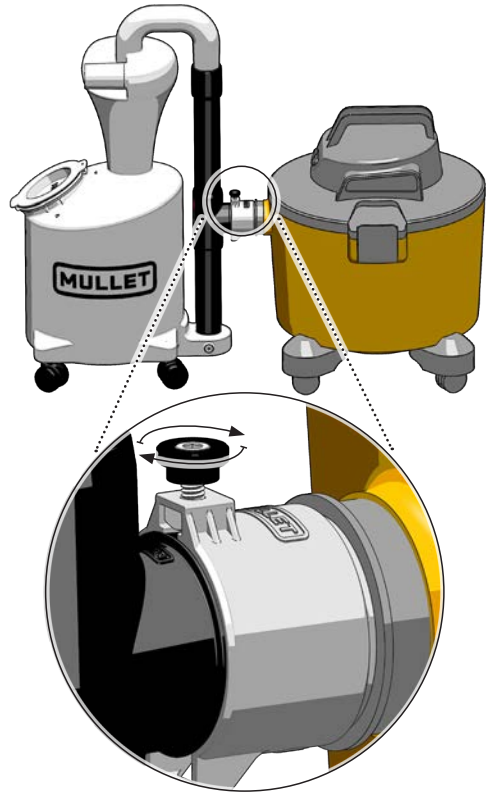

12. INSTALL HOSE ADAPTER

Install second hose adapter on Mullet inlet, as shown.

Optional: Secure hose adapter to Mullet inlet with included self-drilling screw for a more permanent connection. Hand tighten with a Phillips screwdriver to ensure you don't strip the plastic.

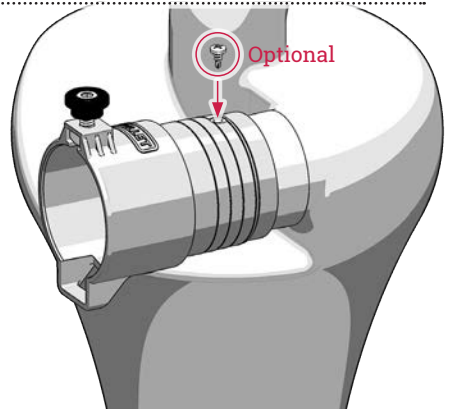

M5

NOW, LET'S EAT SOME DUST

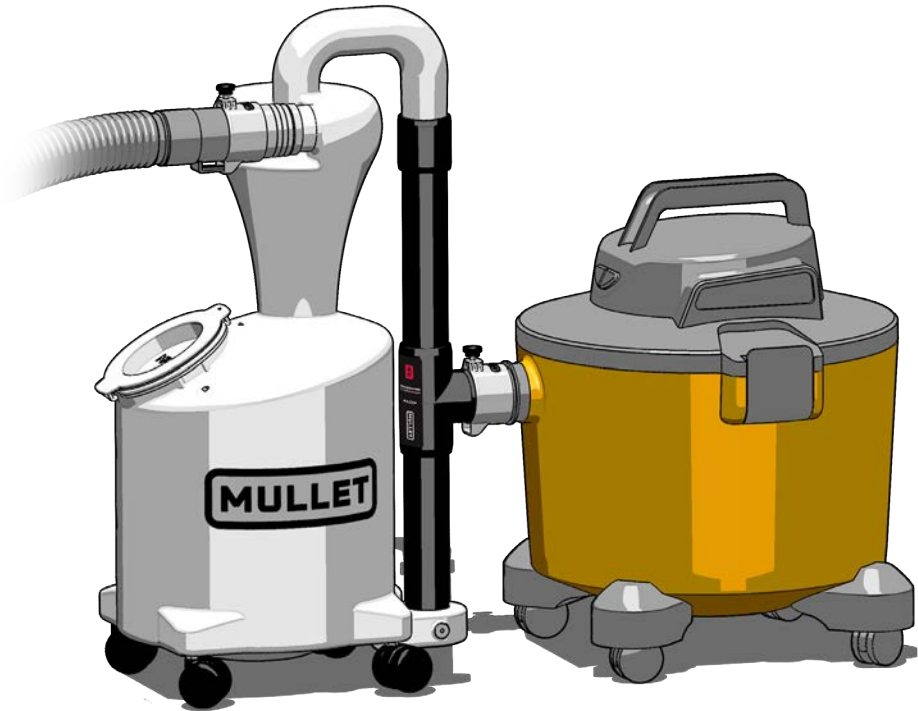

Connect a vacuum hose to hose adapter on Mullet inlet, tightening the thumb screw to ensure a solid and stable connection.

You're now ready to flip on that vac and test out the power of the Mullet cyclone.

DUMPING

When it's time for a dump, remove the vac hose and disconnect Mullet from vac by loosening adapter thumb screw. Beat the bottom like a drum to get rid of the last bit of dust. Before you re-attach, clean the neck area of the dump bin to ensure the o-ring can fully seat.



PRO TIP REDUCE DUST WHEN DUMPING

Fine dust can become airborne when dumping your Mullet. The best way to combat this is to add water to the dump bin before dumping, in effect creating a slurry. Learn more Pro Tips and techniques at www.mullettools.com.

M5

ALTERNATIVE INSTALLATIONS

HARD PLUMBED VAC DROP

The Mullet inlet can be hard plumbed to your shop's dust collection system with other fittings/hoses.

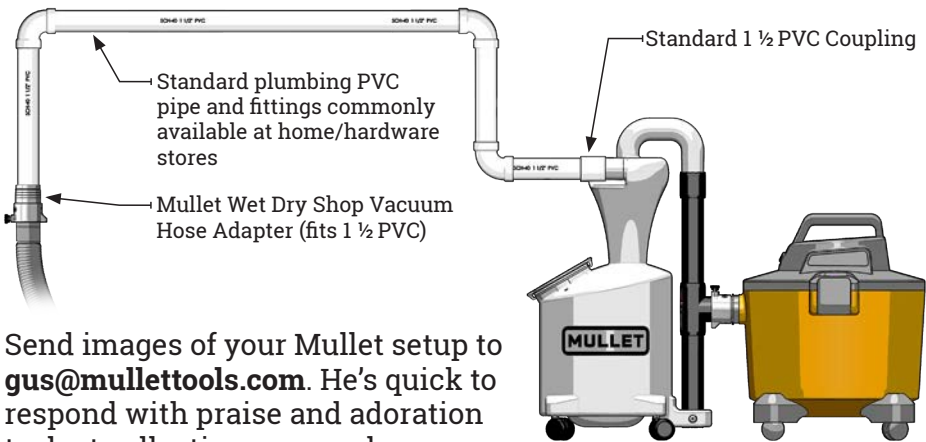

Send images of your Mullet setup to gus@mullettools.com. He's quick to respond with praise and adoration to dust collection eye candy.

PRO TIP HOSE ADAPTER COMPATIBILITY

The Mullet® Wet Dry Shop Vacuum Hose Adapter is compatible with all major OEM wet dry vacs and hoses. So, don't worry about swapping out vacuums and hoses in the future should you want to upgrade your vac.

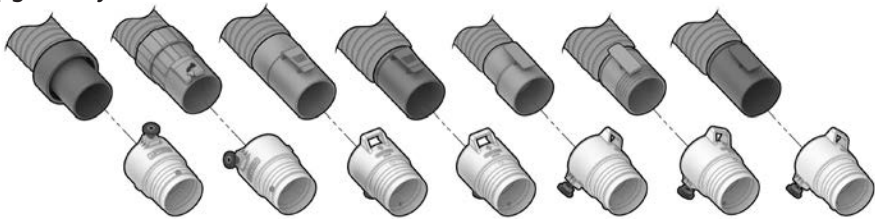

PRO TIP A WORD ABOUT STATIC

Although the Mullet is manufactured using an anti-static resin, you may still experience some amount of static electricity buildup. If this becomes an issue, there are numerous helpful articles and videos online for how to ground your dust collection system. Learn more at www.mullettools.com.

SUPERCHARGE YOUR BLAST CABINET

Capture fine blasted media before it clouds up your view and gets to your dust collector. The Mullet can be hard plumbed between the blast cabinet and dedicated dust collector using PVC pipe/fittings and common rubber plumbing boots.

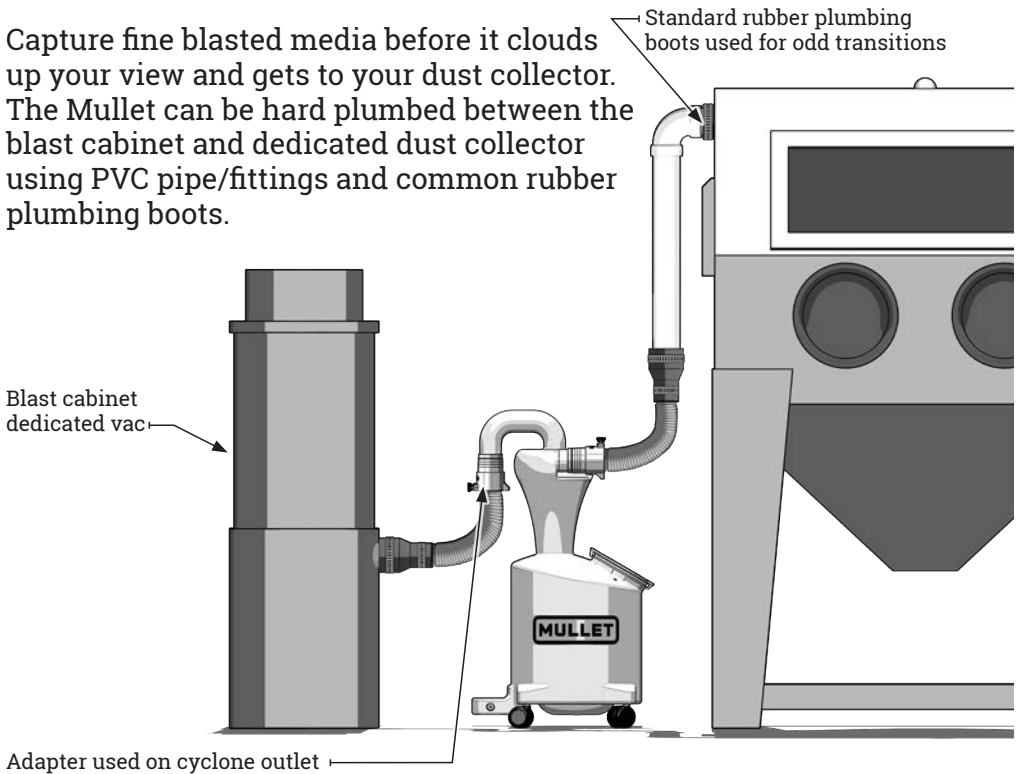

M5

ALTERNATIVE INSTALLATIONS (CONTINUED)

TAKE IT VERTICAL

Who doesn't want to free up more floor space in the shop? The Mullet is built to be re-configured easily. Take the casters off and use the threaded inserts as your starting point. Send pics to gus@mullettools.com. He'd love to see the configuration you come up with.

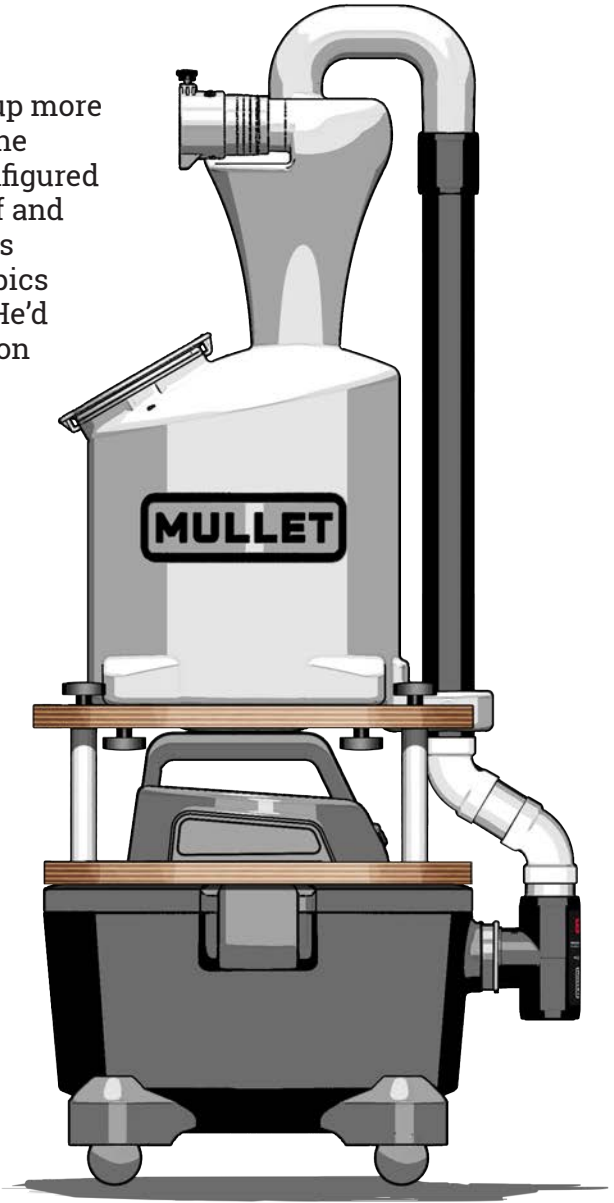

WALL MOUNT IT

Looking for a more permanent mounted position? Head to your local hardware store and pick up a PVC compression coupling. You can use this to attach your Mullet inlet to PVC. If your ducting has a little flex in it, you may be able to connect the Mullet inlet to it using a standard coupling instead. Don't forget to send pics to gus@mullettools.com, as shop envy isn't on his list of seven deadly sins.

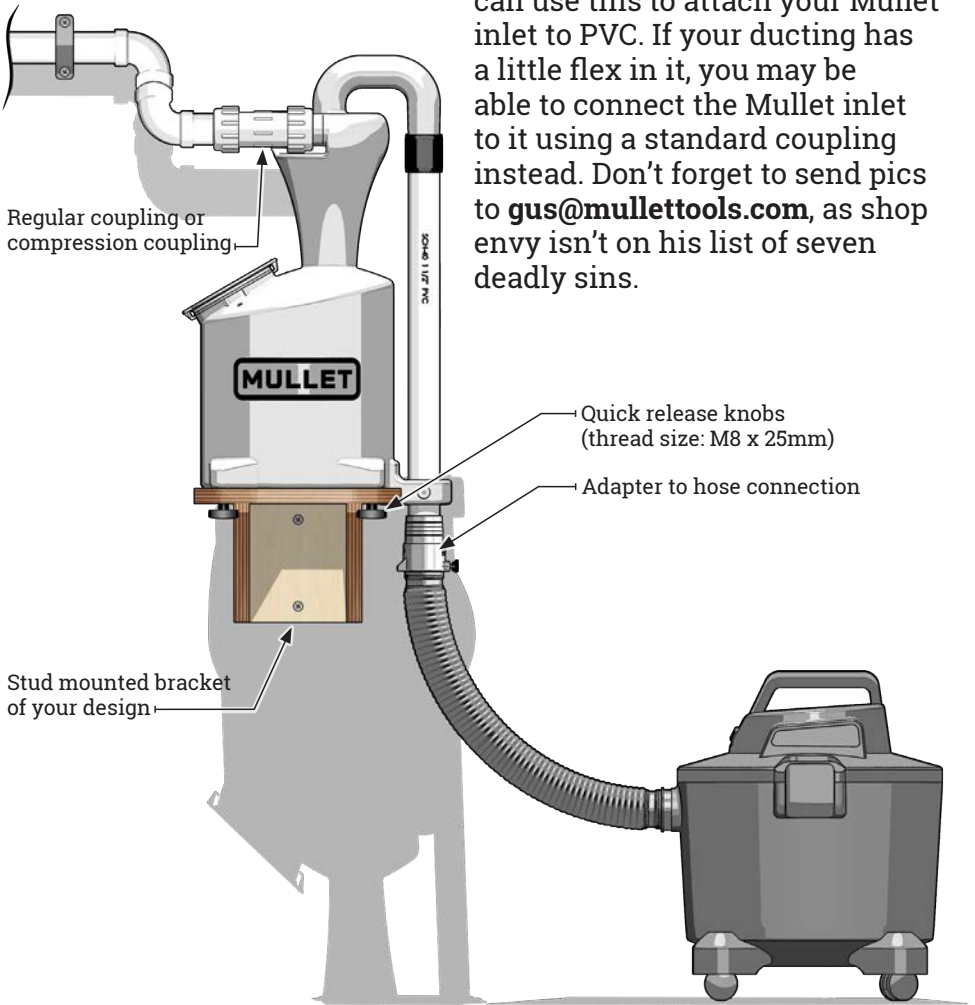

M5

DUMP BIN BASE DIMENSIONS

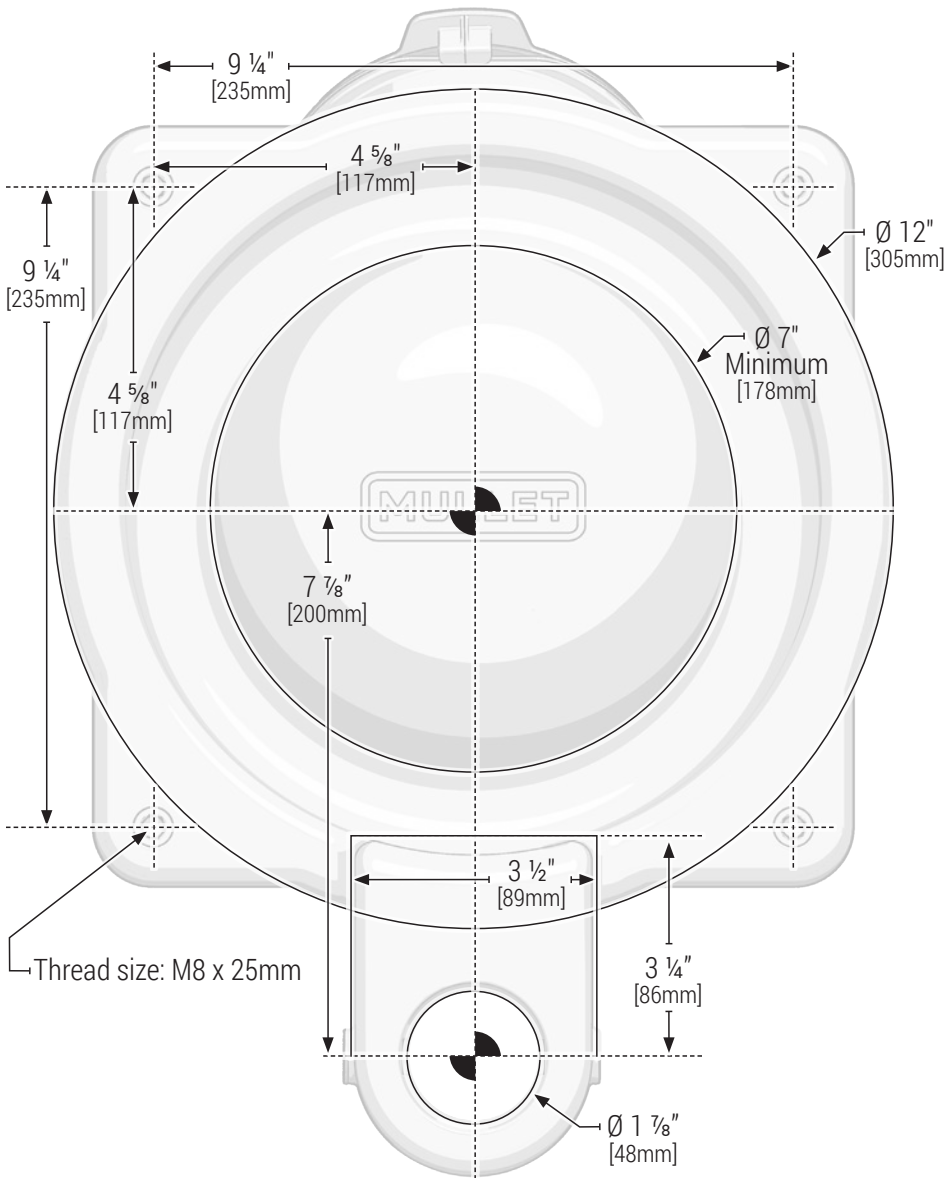

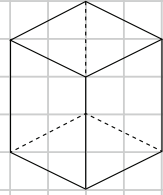

SCALE  =

TROUBLESHOOTING TIPS

1) The hose adapter isn't getting a tight fit on my vac inlet.

Easy peasy. The hose adapter just needs a little flashing added to the outside where it inserts into your vac. A round or two of electrical tape should do the trick. If not, get in touch with gus@mullettools.com.

2) My pipe assembly doesn't fit/line up OR The wheels on the Mullet don't all touch the ground.

Your top and support pipes likely need adjusting. Try disconnecting and reconnecting to the coupling and tee first. Adjust pipe up or down in fittings to create a level fit from tee to adapter in vac. Should you need to trim a bit more pipe, go back through the prior steps to verify where to cut. Be sure to remove any PVC shavings before re-inserting pipe into fittings and ensure cut sticker is fully removed from pipe.

3) Oh \$#@%! I cut the pipe too short.

Don't sweat it. We have replacement pipe you can order from us. And if you can't wait that long, run to your local hardware store and get a couple feet of 1 ½" Schedule 40 PVC pipe.

4) There's little/no suction.

- Double-check tee orientation. Ensure "UP" is on the top side, which allows air to pass through to the vac.
- Check to see if any of the cut sticker is still on the pipe. If so, remove.
- Check for leaks – hose connections, pipe connections, the lid. Check anywhere two pieces are joined together, as even small gaps can compromise performance.
- Check for a blockage. Large chunks of debris can get stuck in hoses or pipes. Use a wire or plumbers snake to dislodge.
- Check the filter on your vac. Even with the Mullet extending the life of your filter, you'll eventually need to clean or replace it.



5) Debris is getting through to the vac.

- Could be time to empty the dump bin. Take a peek through the clear lid.
- Check for an air leak at the lid. Ensure it's installed snugly to the dump bin with the o-ring securely in place and no debris between it and the Mullet.
- It is possible for large, lightweight objects (e.g., EPS foam pieces) to remain suspended in the air stream rather than dropping into the dump bin. Try to sweep or pickup larger debris before vacuuming.
- Some microscopic particles (think drywall dust) can be too light and small for the cyclone action to take effect. Try a filter bag if some slip through the exhaust on your vac.

6) My vac has an angled inlet.

- In the unlikely case that it does, we have a free 3D printed Hose Adapter to get you hooked up in no time. Contact gus@mullettools.com.

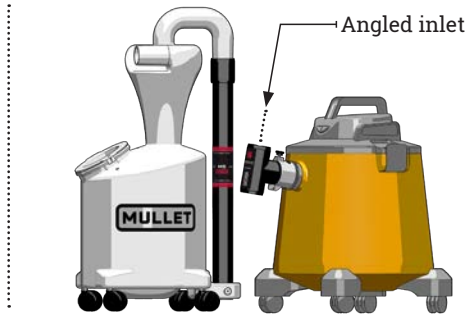
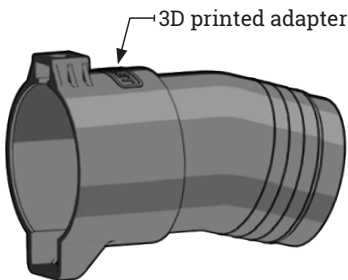

Your question not answered here? Get in touch with our man, Gus.
gus@mullettools.com



Mullet Tools, LLC
PO Box 1106
Dripping Springs, TX 78620
mullettools.com