



# **MB160**

## Pushchair

**GB** Instruction Manual

**ES** Manual de instrucciones



**IMPORTANT, RETAIN FOR FUTURE REFERENCE: READ CAREFULLY**

# Welcome to the familiee

Your trust in our product means the world to us, and we're thrilled to be a part of your parenting journey. Our team has worked tirelessly to ensure that this product provides comfort, safety, and style for you and your little one. We're confident it will exceed your expectations. Should you have any questions or require assistance in the future, please don't hesitate to reach out. Thank you for choosing My Babiie; we wish you and your family countless wonderful strolls ahead.

## Get to know your MB160 Pushchair

Scan the QR code below on your camera app to be linked off to our page to get all the information you need for using your Pushchair. From setting it up to how to fold it down, it's all there!



# Safety & care notes

---

## IMPORTANT - READ CAREFULLY AND KEEP THESE INSTRUCTIONS FOR FUTURE REFERENCE

Remove all packaging and non-permanent labels and dispose of safely before using this product. The safety of your child could be put at risk if you do not follow these instructions. This stroller is designed for 1 child from 0 months up to a weight of 22 kg.

**WARNING:** Never leave the child unattended.

**WARNING:** Uneven or excessive loading of items on or in the stroller may cause the product to tip and may cause injury.

**WARNING:** Maximum intended weight within the shopping basket is 3kg.

**WARNING:** Ensure that all the locking devices are engaged before use.

**WARNING:** To avoid injury ensure that the child is kept away when unfolding and folding this stroller.

**WARNING:** Do not let the child play with this product.

**WARNING:** Always use the restraint system.

**WARNING:** Check that the stroller body is correctly engaged before use.

**WARNING:** Do not put hot drinks or liquids in the cup holder.

**WARNING:** This product is not suitable for running or skating.

**WARNING:** Do not insert any additional mattresses into the stroller.

**WARNING:** Accessories which are not approved by the manufacturer shall not be used.

**WARNING:** This pushchair has been designed for one child and shall be used for the transport for only one child!

**WARNING:** Always use the crotch strap in combination with the waist belt.

**WARNING:** This stroller does not replace a cot or a bed. Should your child need to sleep, then it should be placed in a suitable cot or bed.

**WARNING:** Only replacement parts supplied or recommended by My Babiie shall be used.

**WARNING:** Any load attached to the handle and on the back of the backrest and on the sides of the stroller will affect the stability of the stroller.

**WARNING:** The parking device shall be engaged when placing and removing the children.

EN 1888-1:2018+A1:2022 and EN 1888-2:2018+A1:2022 approved

## Care and Maintenance

- Please check on a regular basis that the brakes, wheels, latches, connecting elements, belt systems and seams are properly functional.
- Do not expose the stroller to strong sunshine.
- Sponge clean only.
- After use in rain or snow, the wheels should be lubricated and the stroller dried to prevent rust.
- Care for, clean and check this stroller regularly.

---

## Your child's safety is your responsibility

If you have a problem with this product or require replacement parts, please visit [www.mybabiie.com/support](http://www.mybabiie.com/support)

Register your product at: [www.mybabiie.com/warranties](http://www.mybabiie.com/warranties)

# What's in the box

---

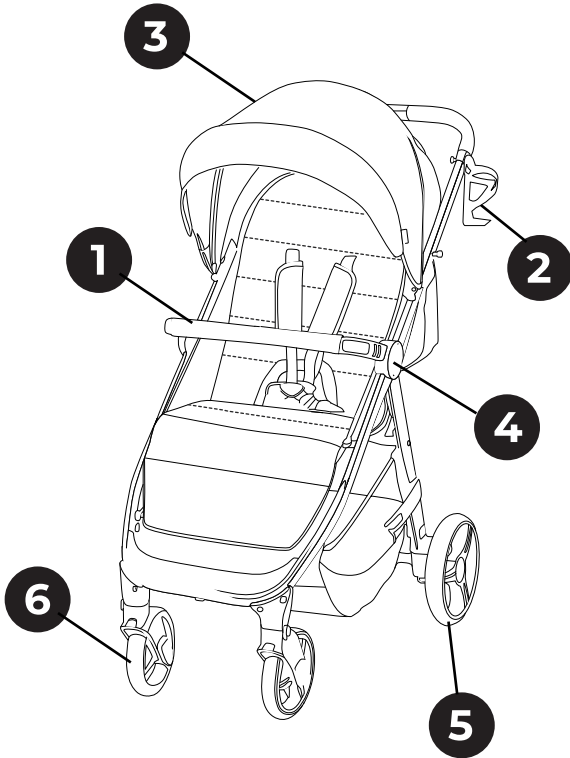

1. Bumper bar
2. Cup holder
3. Canopy
4. Frame
5. Rear wheels (x2)
6. Front wheels (x2)
7. Footmuff
8. Raincover

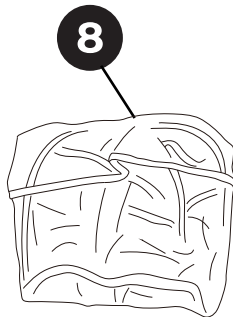
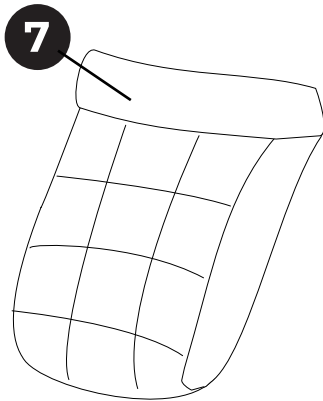

# Assembly instructions

## Opening the pushchair

- Unhook the latch on the outside of the stroller as shown below, while pulling the handle with your other hand to unfold the stroller.
- Push the lock to the outside of the stroller as shown below and at the same time pull up the handle with the other hand to unfold the stroller.

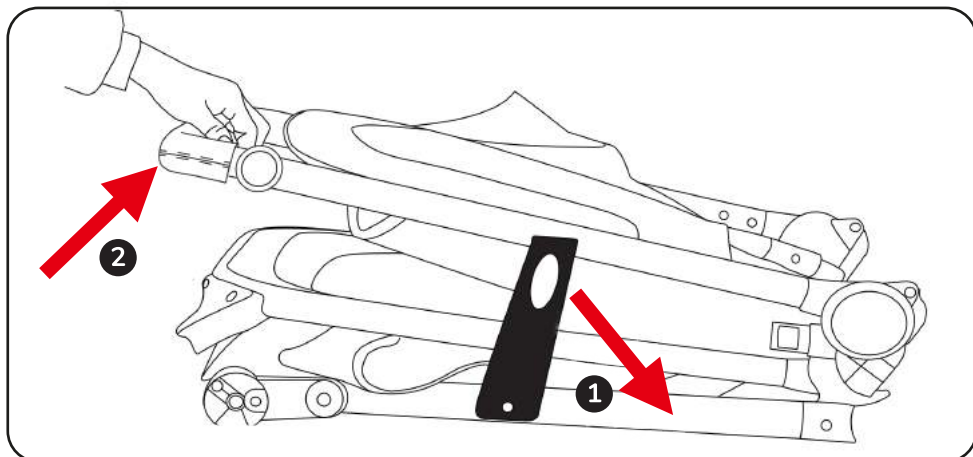

- When the stroller is opened, you should hear "click" sounds on both sides of the stroller, please examine if the stroller is locked in safety position before you use it.

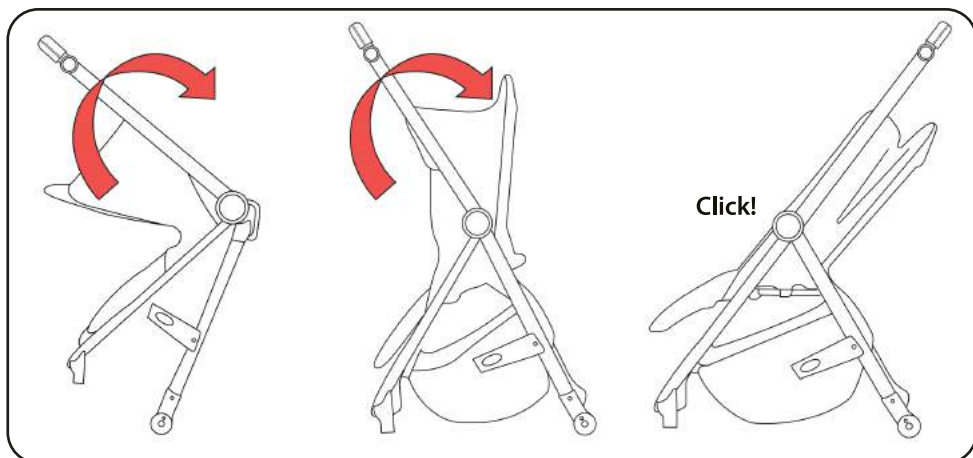

# Assembly instructions

---

## Attaching the bumper bar

Insert the bumper on both sides of the seat as shown. Note: Please make sure to lock the bumper in place when you heard a "click" sound.

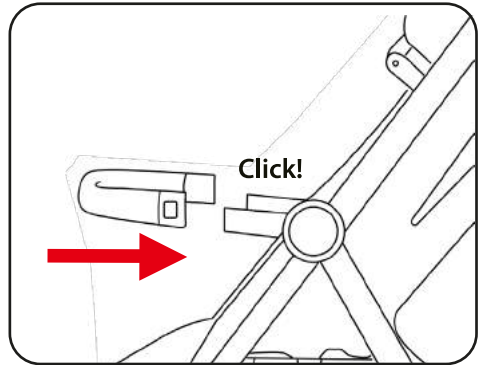

## Attaching the hood

Insert the hood plastic into the seat as shown.

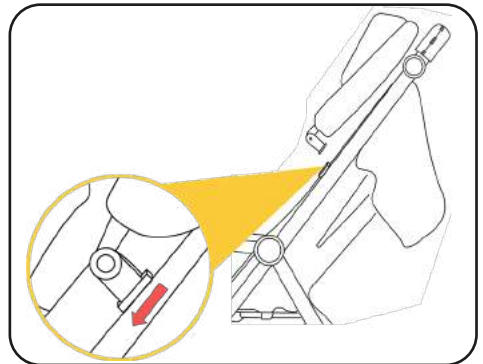

## Attaching the front wheels

Take out the front wheels, insert the vertical shaft into the plastic hole on the wheel seat as shown, until it is locked, install the other side of the front wheel in the same way.

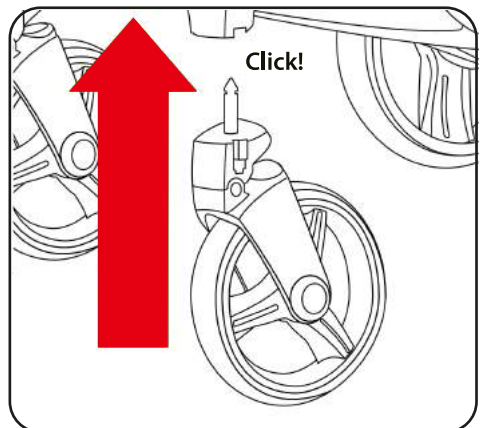

# Assembly instructions

## Attaching the rear wheels

Take one side of rear wheels, Insert the rear axle into the plastic hole as shown, until it is locked, install the other side of the rear wheel in the same way.

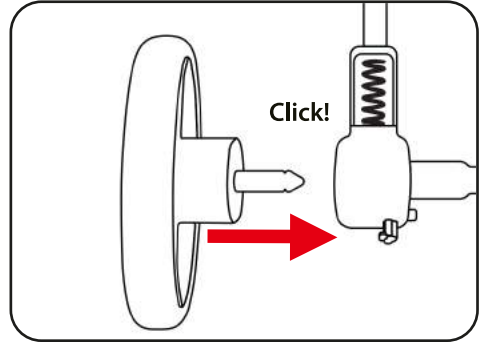

The bumper bar can be detached on one side and rotated up or down to make getting the child in or out the pushchair easy. Push the button on the side of the bumper bar to release it.

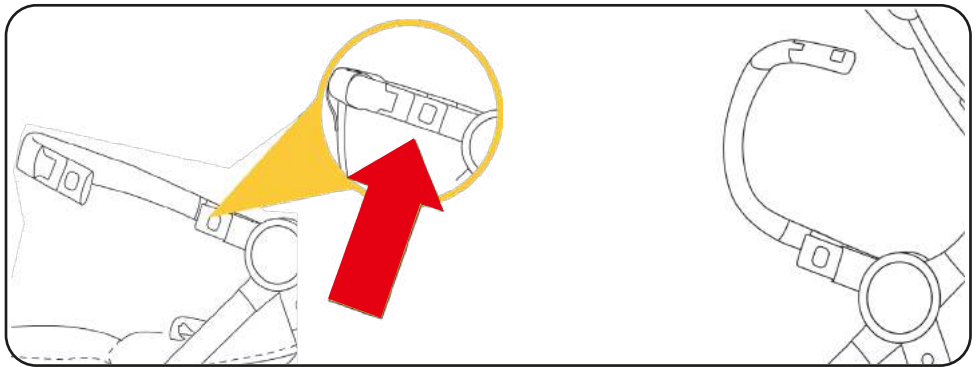

The canopy can be fully extended as shown.

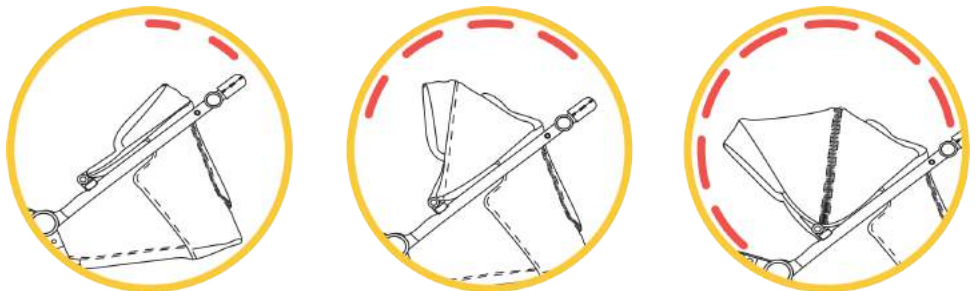

# Assembly instructions

## Adjusting the backrest

Pull up the plastic button on the back of the backrest and adjust the backrest to any of 3 available positions (sleeping or seated).

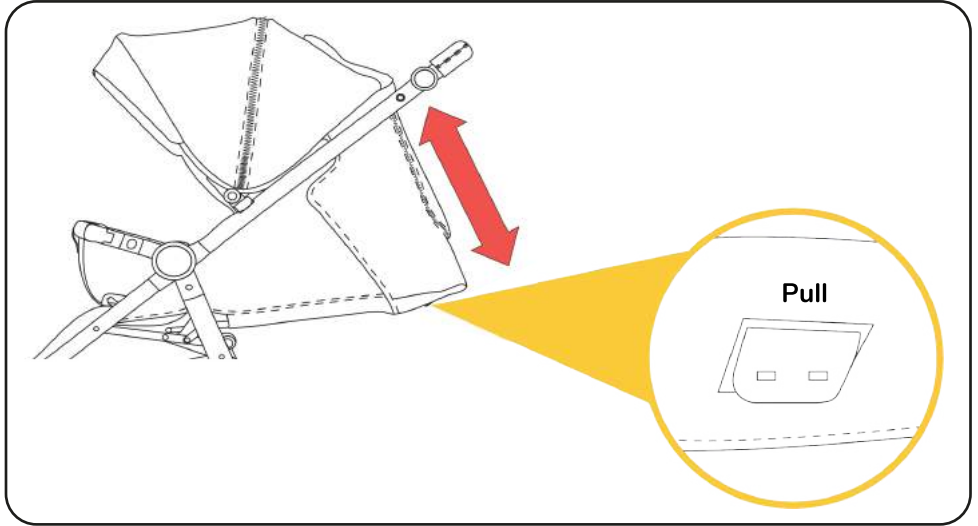

## Swivel front wheels

Lift up the plastic button on the front wheels to lock the wheels in position, press down the plastic button to release it so the wheel can be rotated 360 degrees.

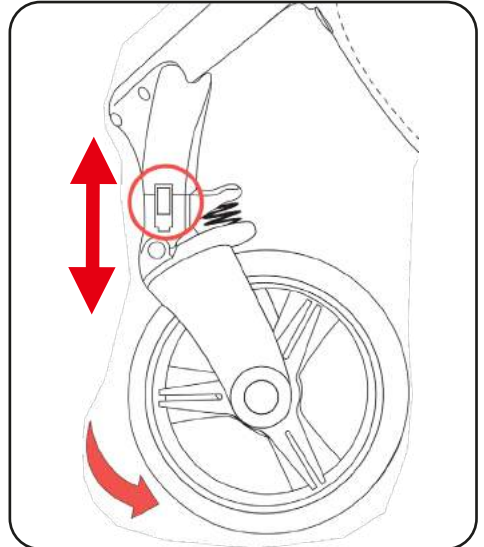



# Assembly instructions

---

## Releasing the front wheels

Press the small metal pins, at the same time use your hand to pull out the front wheel.

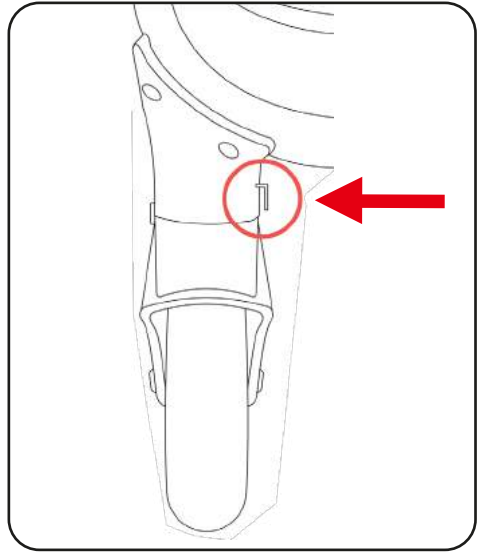

## Releasing the rear wheels

Pull the rear wheel release catch down, remove the rear wheel in the direction of arrow left.

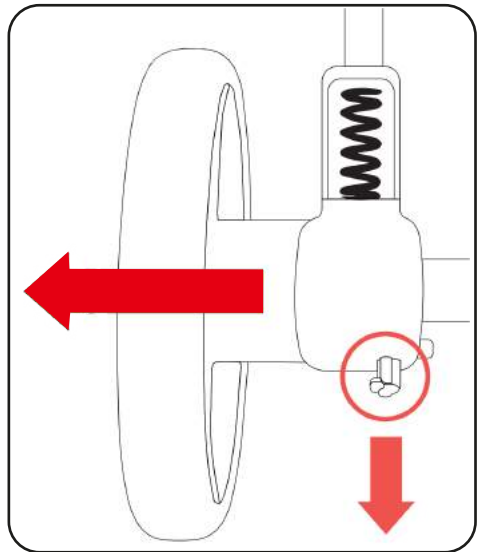

# Assembly instructions

## Using the brake

Step down the brake pedal to brake the stroller, lift up the pedal to release the brake.

**Warning:** Always lock the brake when putting in or taking out the child!

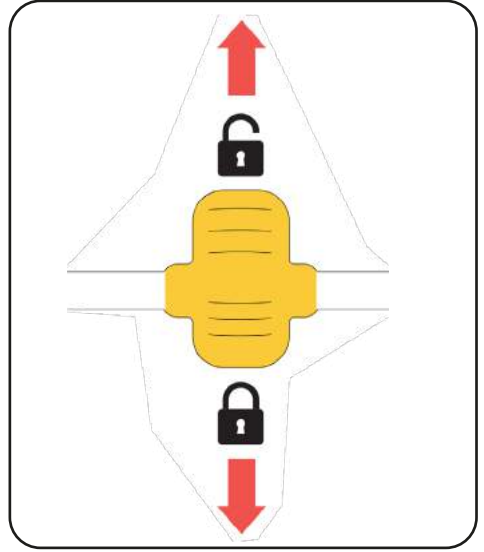

## Using the leg rest

Pull the button on the side of the leg rest to adjust the footrest. There are 3 footrest positions.

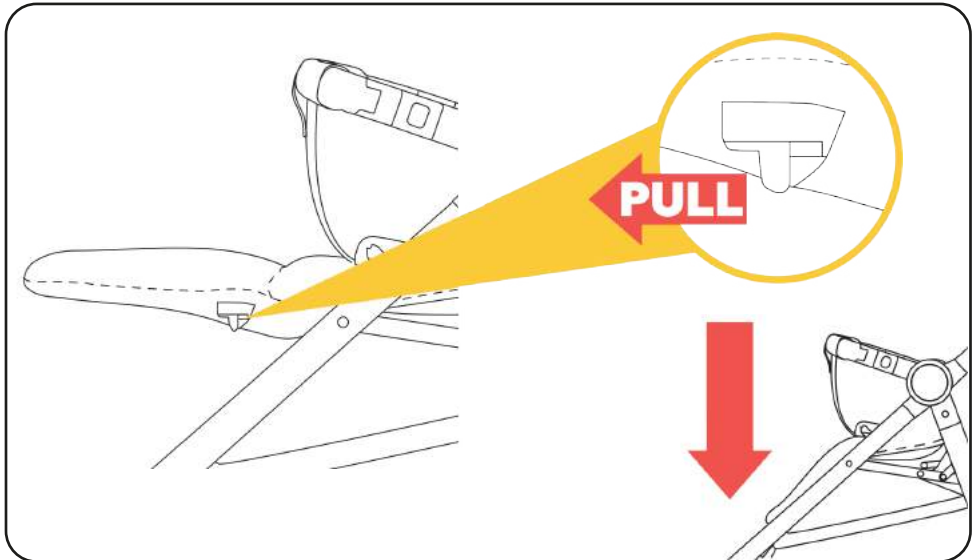

# Assembly instructions

---

## Folding the pushchair

Press the second lock and at the same time press the folding button on the handle as shown (b) to unlock the stroller, then push the handle forward (c). With your other hand grab the folding tube under the seat as shown (d), pull the stroller up by holding the folding tube under the seat to fold the stroller.

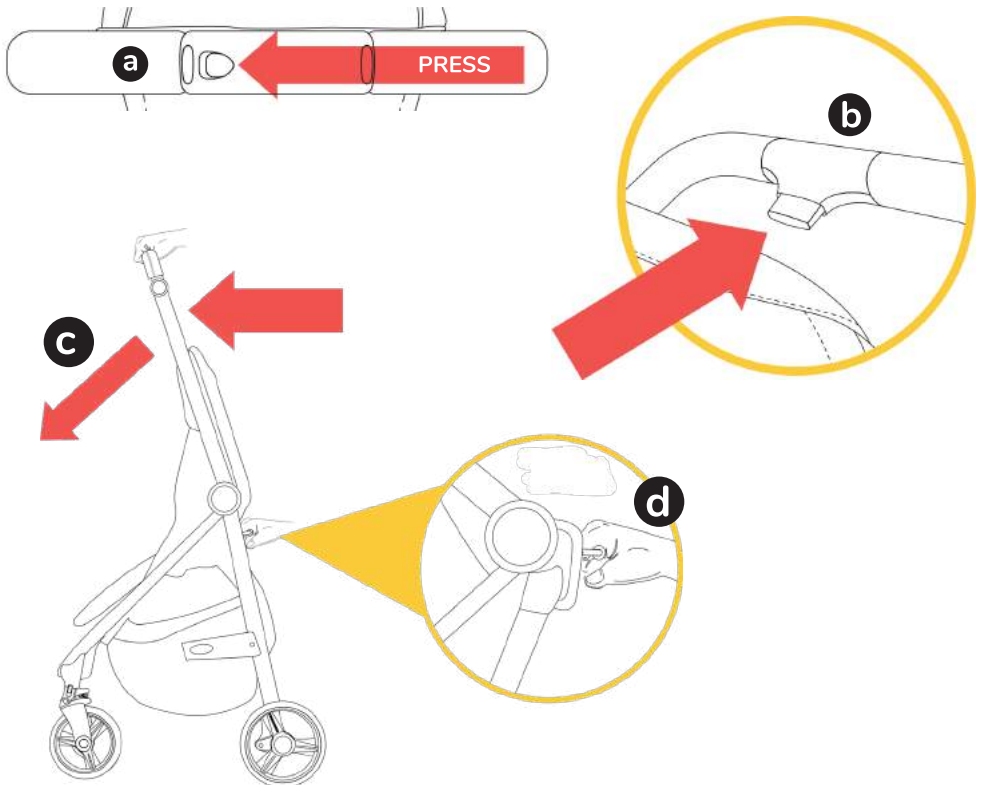

# Assembly instructions

---

## Folding the pushchair

After the stroller is fully folded the folding lock will automatically lock the pushchair into the closed position.

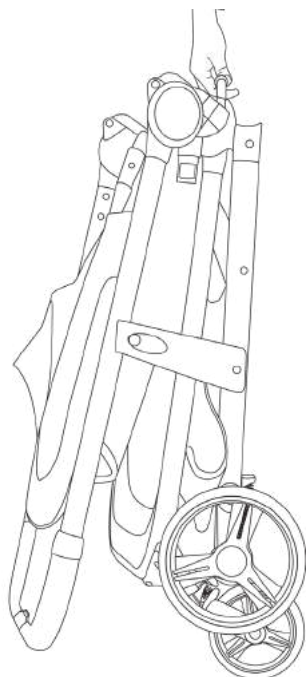

## Using the harness

Click the buckles together to lock together the safety belt on both sides.  
Press the middle button to release the safety harness buckles.

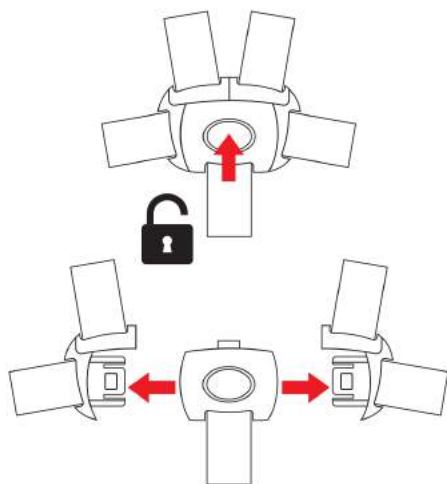
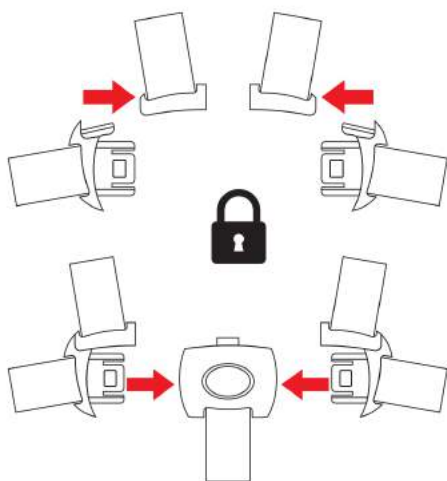

# Pushchair do's & don'ts



## Do use your brakes!

Ensure the parking brake is engaged during the loading and unloading of children & when the pushchair is stationary.

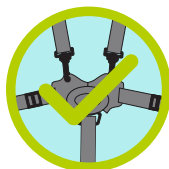

## Do always use the restraint system!

Ensure that the child restraint system is correctly fitted at all times.



## Do keep your pushchair clean and dirt free.

Use a clean white cloth, warm water and a mild detergent to keep your pushchair clean.

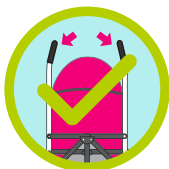

## Do always keep two hands on the handles when pushing.

You could lose control of your pushchair if not steering with both hands.



## Do follow manufacturers instructions when assembling and using your pushchair.

For safety, please refer to our instruction manuals or contact customer support if you're unsure.



## Don't use your pushchair up and down stairs!

Don't use your pushchair up or down stairs or to bump kerbs.



## Don't hang bags off the handles!

Bags and other items should not be hung from the handles as this can affect the stability of the pushchair.



## Don't run or skate with your pushchair!

Our products are not suitable for running or skating.



## Don't carry the stroller with baby inside!

Our pushchairs are not designed to be carried with your baby inside them.



## Don't put hot drinks in the cup holder.

Hot drinks burn and can easily spill from the bottle holder.



## Don't jetwash your pushchair.

Some jet washers are very powerful and could damage parts of your pushchair!



## Don't leave your child un-attended in their pushchair.

Always keep your child and pushchair in view to avoid accidents.



## Don't treat your pushchair like a trolley.

Don't load your pushchair up with all your shopping as they are not built for this purpose and could cause damage.



## Don't use your pushchair as a bumper cart!

Damage can easily occur if your pushchair is knocked into other things.



## Don't smoke around your pushchair.

We wouldn't want your pushchair or little one getting hurt or damaged!



## Don't leave your pushchair unattended on extreme gradients.

Even with your brakes on your pushchair is at risk from tipping or sliding on extreme gradients!



## Don't sit in the pushchair unless the user is under the guideline weight.

Our pushchairs are designed to hold a maximum weight. If exceeded this will cause damage!



## Do enjoy your My Babie product!

Go out and have fun adventures with your little one!

# Notas de seguridad y cuidado

---

## IMPORTANTE - LEA CUIDADOSAMENTE Y GUARDE ESTAS INSTRUCCIONES PARA FUTURAS CONSULTAS

Retire todo el embalaje y las etiquetas no permanentes y deséchelos de manera segura antes de usar este producto. La seguridad de su hijo podría correr peligro si no sigue estas instrucciones.

Este cochecito está diseñado para 1 niño desde 0 meses hasta un peso de 22 kg.

**ADVERTENCIA:** Nunca deje al niño desatendido.

**ADVERTENCIA:** La carga desigual o excesiva de artículos sobre o dentro de la carriola puede hacer que el producto se vuelque y cause lesiones.

**ADVERTENCIA:** El peso máximo previsto dentro de la cesta de la compra es de 3 kg.

**ADVERTENCIA:** Asegúrese de que todos los dispositivos de bloqueo estén activados antes de su uso.

**ADVERTENCIA:** Para evitar lesiones, asegúrese de que el niño se mantenga alejado al desplegar y plegar este cochecito.

**ADVERTENCIA:** No permita que el niño juegue con este producto.

**ADVERTENCIA:** Utilice siempre el sistema de retención.

**ADVERTENCIA:** Verifique que el cuerpo del cochecito esté correctamente acoplado antes de su uso.

**ADVERTENCIA:** No coloque bebidas o líquidos calientes en el portavasos.

**ADVERTENCIA:** Este producto no es apto para correr o patinar.

**ADVERTENCIA:** No inserte colchones adicionales en la carriola.

**ADVERTENCIA:** No se deben utilizar accesorios que no estén aprobados por el fabricante.

**ADVERTENCIA:** ¡Este cochecito ha sido diseñado para un niño y debe usarse para el transporte de un solo niño!

**ADVERTENCIA:** Utilice siempre la correa de la entrepierna en combinación con el cinturón.

**ADVERTENCIA:** Este cochecito no reemplaza una cuna o una cama. Si su hijo necesita dormir, debe colocarlo en una cuna o cama adecuada.

**ADVERTENCIA:** Solo se deben utilizar piezas de repuesto suministradas o recomendadas por My Babiie.

**ADVERTENCIA:** Cualquier carga adherida a la manija y en la parte posterior del respaldo y en los costados de la carriola afectará la estabilidad de la carriola.

**ADVERTENCIA:** El dispositivo de estacionamiento debe estar activado al colocar y retirar a los niños.

EN 1888-1:2018+A1:2022 y EN 1888-2:2018+A1:2022 aprobado

## Cuidado y mantenimiento

- Compruebe periódicamente que los frenos, las ruedas, los pestillos, los elementos de conexión, el cinturón

los sistemas y las costuras funcionan correctamente.

- No exponga el cochecito a la luz solar intensa.
- Solo limpie con esponja.
- Después de su uso bajo la lluvia o la nieve, se deben lubricar las ruedas y secar la carriola para evitar la oxidación.
- Cuide, limpie y revise este cochecito regularmente.

---

La seguridad de tu hijo es tu responsabilidad

Si tiene un problema con este producto o necesita piezas de repuesto, visite [www.mybabiie.com/support](http://www.mybabiie.com/support)

Registre su producto en: [www.mybabiie.com/warranties](http://www.mybabiie.com/warranties)

# Qué hay en la caja

---

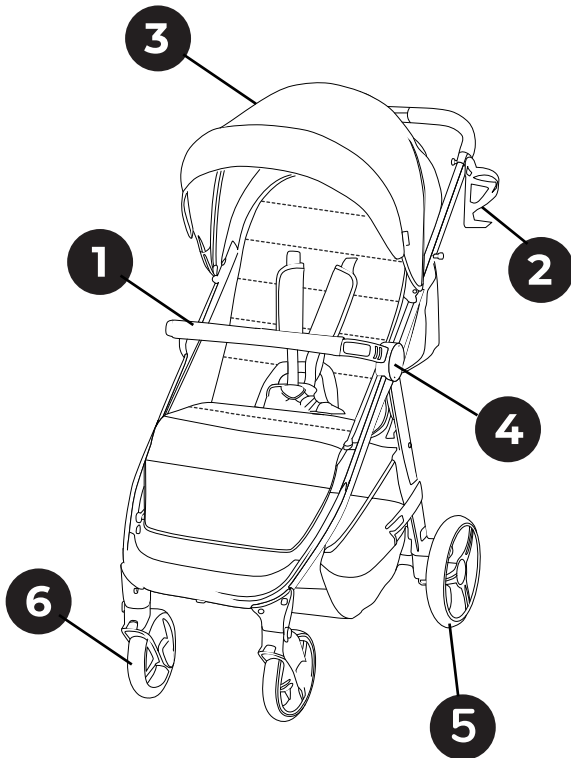

1. Barra de parachoques
2. P|osavastos
3. Pabellón
4. Marco
5. Ruedas traseras (x2)
6. Ruedas frontales (x2)
7. Cubrepiés
8. protector de lluvia

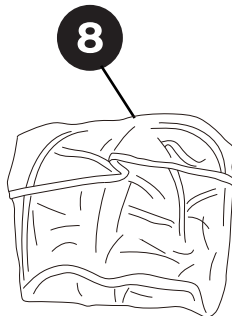
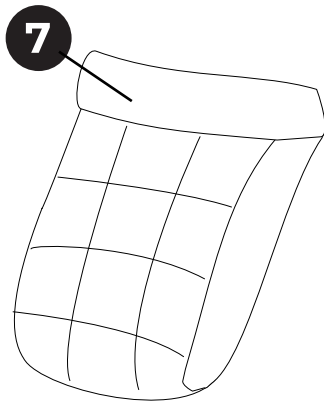

# Instrucciones de montaje

## Abriendo la silla de paseo

- Desenganche el pestillo en el exterior de la carriola como se muestra a continuación, mientras tira de la manija con la otra mano para desplegar el cochecito.
- Empuje el bloqueo hacia el exterior de la carriola como se muestra a continuación y al mismo tiempo levante el empuñadura con la otra mano para desplegar la carriola.

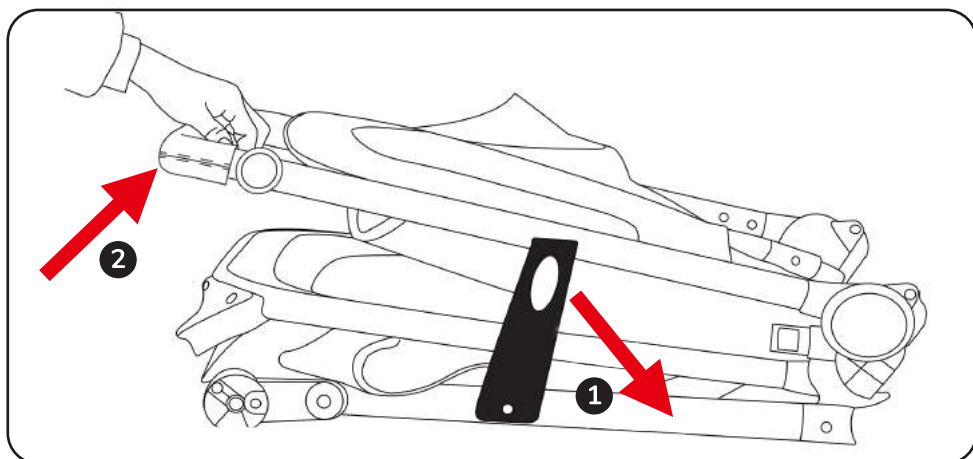

- Cuando se abre la carriola, debe escuchar sonidos de "clic" en ambos lados de la carriola, compruebe si la carriola está bloqueada en la posición de seguridad antes de usarla.

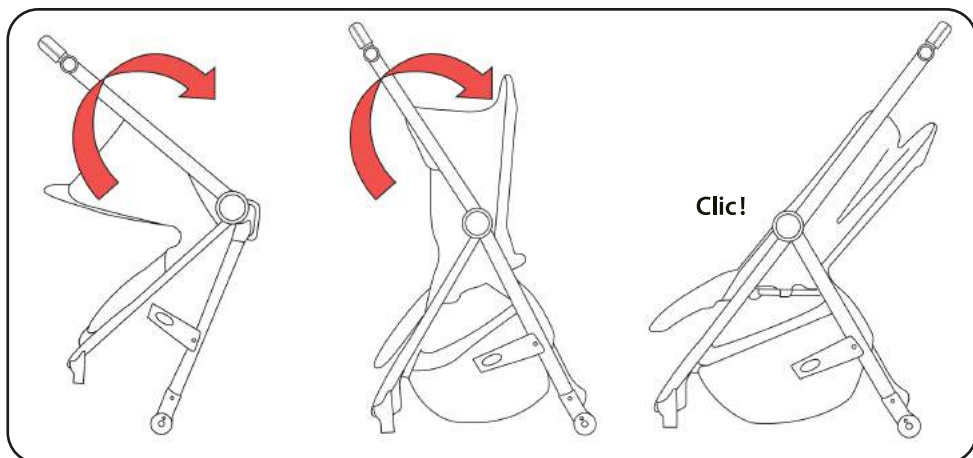



# Instrucciones de montaje

## Fijación de la barra de parachoques

Inserte el parachoques en ambos lados del asiento como se muestra. Nota: asegúrese de bloquear el parachoques en su lugar cuando escuche un "clic".

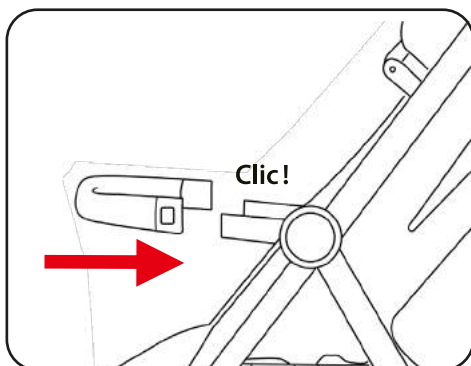

## Colocación de la capucha

Inserte el plástico de la capota en el asiento como se muestra.

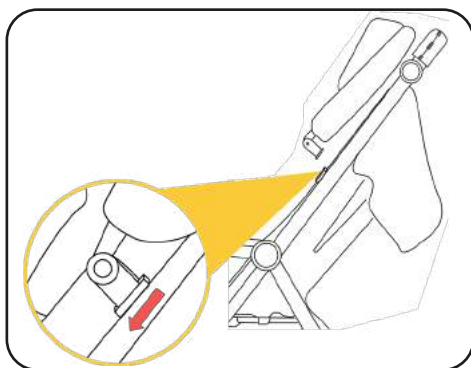

## Colocación de las ruedas delanteras

Saque las ruedas delanteras, inserte el eje vertical en el orificio de plástico en el asiento de la rueda como se muestra, hasta que quede bloqueado, instale el otro lado de la rueda delantera de la misma manera.

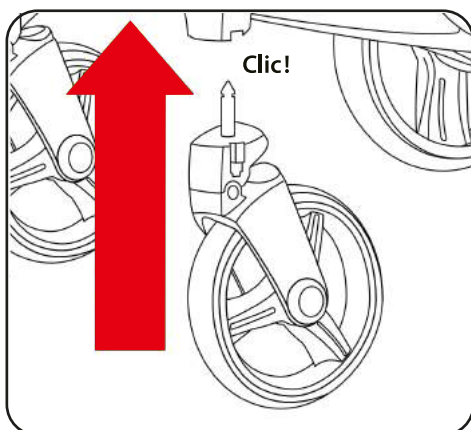

# Instrucciones de montaje

## Colocación de las ruedas traseras

Tome un lado de las ruedas traseras, inserte el eje trasero en el orificio de plástico como se muestra, hasta que quede bloqueado, instale el otro lado de la rueda trasera de la misma manera.

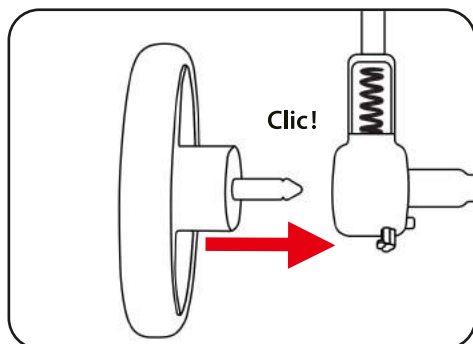

La barra protectora se puede desmontar por un lado y girar hacia arriba o hacia abajo para facilitar la entrada o salida del niño del cochecito. Presione el botón en el lado de la barra de parachoques para liberarlo.

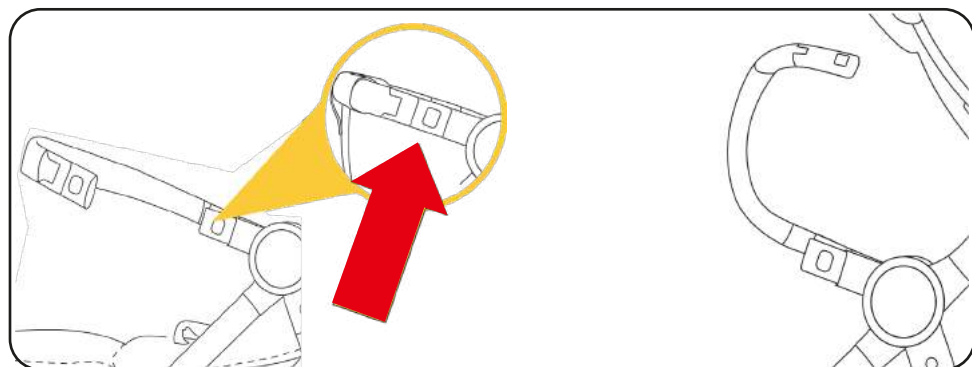

El dosel se puede extender completamente como se muestra.

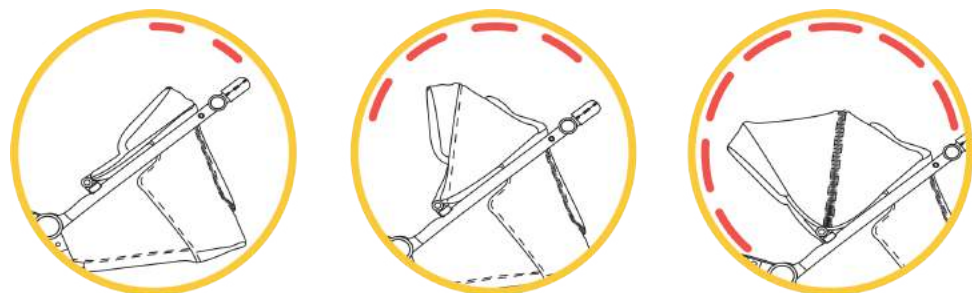

# Instrucciones de montaje

## Ajuste del respaldo

Tire hacia arriba del botón de plástico en la parte posterior del respaldo y ajuste el respaldo en cualquiera de las 3 posiciones disponibles (dormido o sentado).

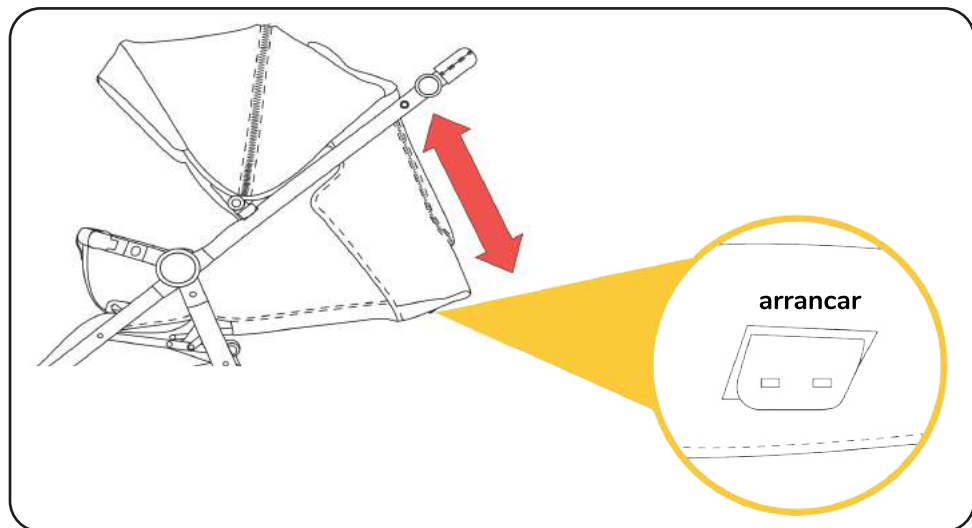

## Ruedas delanteras giratorias

Levante el botón de plástico de las ruedas delanteras para bloquear las ruedas en su posición, presione el botón de plástico hacia abajo para soltarlo y que la rueda pueda girar 360 grados.

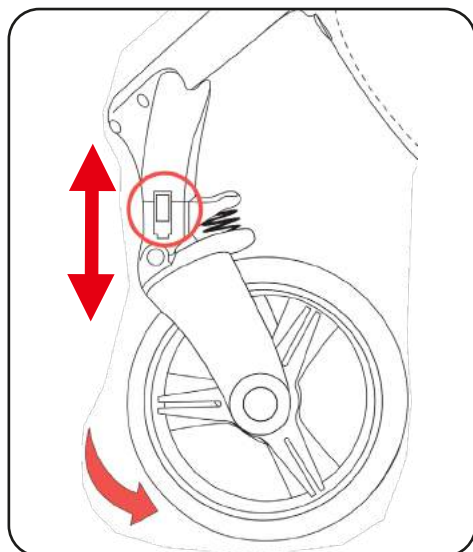

# Instrucciones de montaje

## Liberación de las ruedas delanteras

Presione los pasadores de metal pequeños, al mismo tiempo use su mano para sacar la rueda delantera.

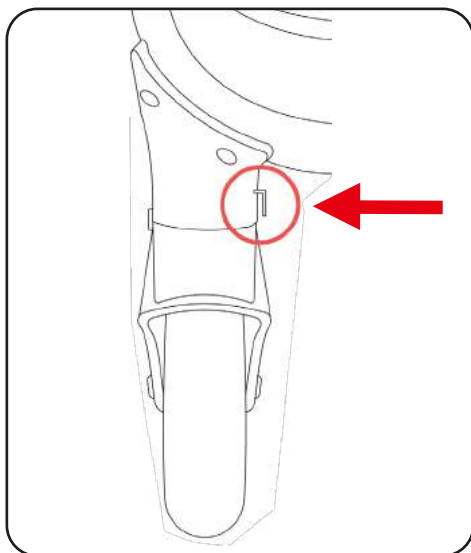

## Soltar las ruedas traseras

Tire hacia abajo del pestillo de liberación de la rueda trasera, retire la rueda trasera en la dirección de la flecha hacia la izquierda.

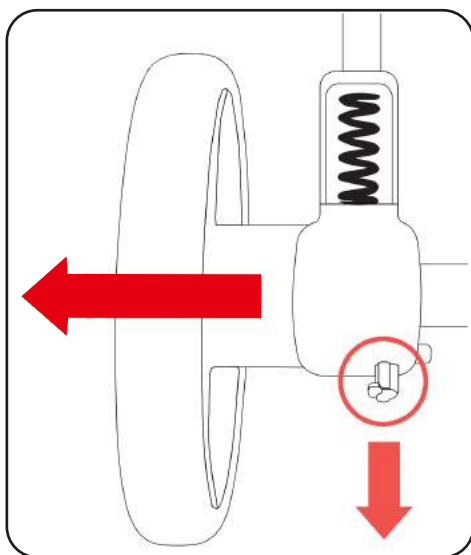

# Instrucciones de montaje

## Usando el freno

Baje el pedal del freno para frenar la carriola, levante el pedal para soltar el freno.

Advertencia: ¡Siempre bloquee el freno cuando suba o saque al niño!

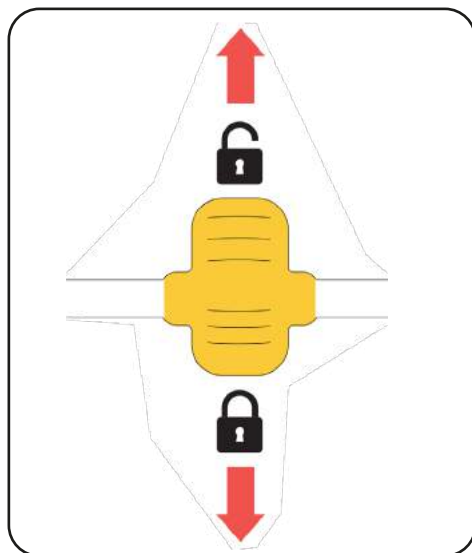

## Uso del reposapiés

Jale el botón en el costado del reposapiés para ajustar el reposapiés. Hay 3 posiciones de reposapiés.

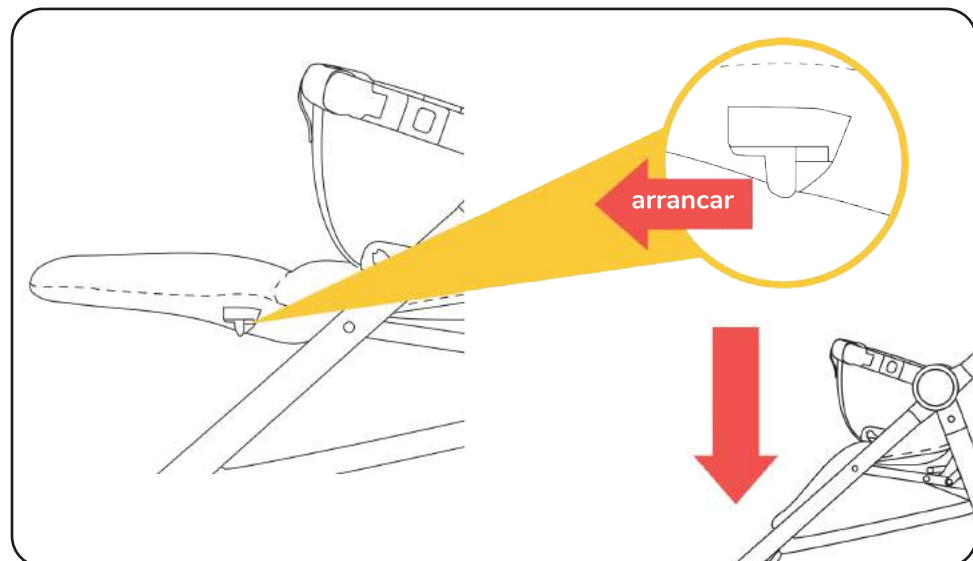

# Instrucciones de montaje

## plegar la silla de paseo

Presione el segundo bloqueo y, al mismo tiempo, presione el botón de plegado en la manija como se muestra (b) para desbloquear la carriola, luego empuje la manija hacia adelante (c). Con la otra mano, tome el tubo plegable debajo del asiento como se muestra (d), tire del cochecito hacia arriba sujetando el tubo plegable debajo del asiento para plegar el cochecito.

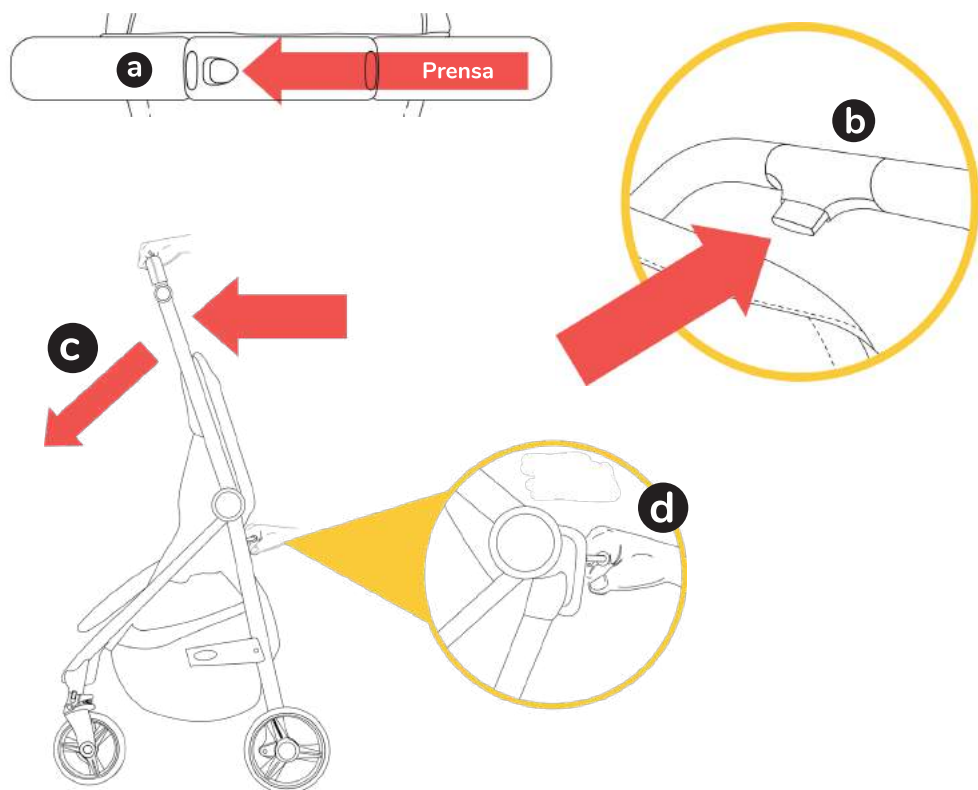

# Instrucciones de montaje

## plegar la silla de paseo

Una vez que la carriola esté completamente plegada, el bloqueo de plegado bloqueará automáticamente la carriola en la posición cerrada.

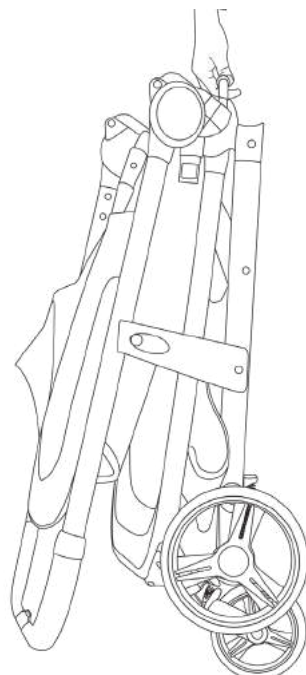

## Usando el arnés

Haga clic en las hebillas para unir el cinturón de seguridad en ambos lados.  
Presione el botón central para liberar las hebillas del arnés de seguridad.

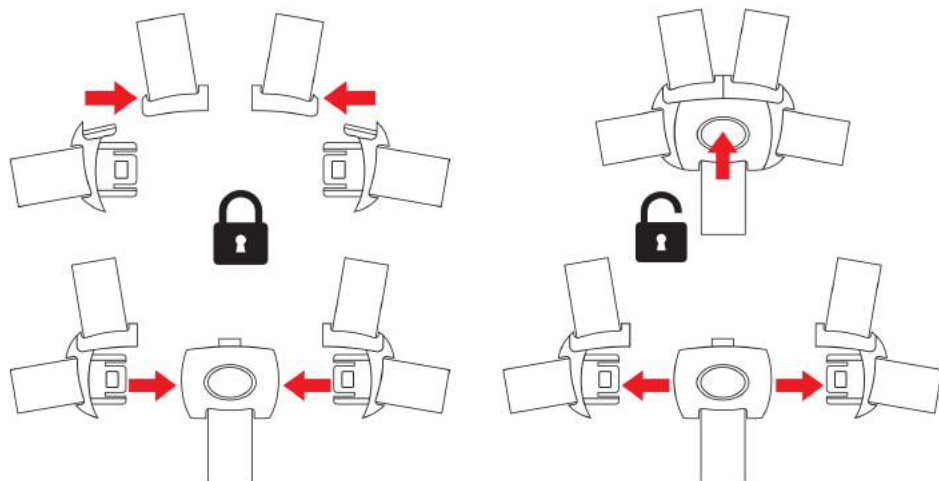

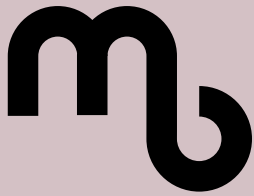

## Register your product

[www.mybabiie.com/warranties](http://www.mybabiie.com/warranties)

In the first instance of needing assistance please contact your original place of purchase.

This product qualifies for 12 month warranty when registered through our website

[mybabiie.com](http://mybabiie.com)



My Babiie



@MyBabiieOfficial



My Babiie



@mybabiie\_official



@MyBabiie

My Babiie Ltd, Paddock Wood, Kent, TN12 6EN

My Babiie EU , Generaal Vetterstraat 76A, 1059 BW Amsterdam, The Netherlands