

UPRIGHT COLOR OPTIONS



PLATINUM



SATIN BLACK

Model number	XCW-1M
Footprint	36.7" x 53.9" (93 cm x 136 cm)
Height	Frame 95.8" (243 cm)
Minimum Required Live Area	11' x 8.5' (3.37 m x 2.59 m)
Warranty	10 year frame and welds/1 year parts/90 days misc.

TOP VIEW

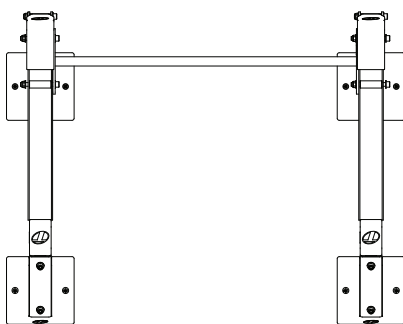

MODULE OPTIONS

- STORAGE MODULE
- BALL & HANGING STORAGE
- STALL BARS
- BALL TARGET WALL PAD
- MODULE EXTENSION

ATTACHMENT OPTIONS

- BALL TARGET
- BATTLE ROPE ANCHOR
- BALL & HANGING STORAGE EXTENSION
- GROUND ROTATIONAL TRAINER
- BAR/WEIGHT STORAGE
- DIP ATTACHMENT
- PLYO-STEP ATTACHMENT
- 3D HEAVY BAG SWIVEL
- RELENTLESS ROPE

NOTE: X-Create systems are required to be bolted to a concrete sub-floor. Accessories shown sold separately.



UPRIGHT COLOR OPTIONS



PLATINUM



SATIN BLACK

Model number	XCW-2M
Footprint	36.7" x 99" (93 cm x 251cm)
Height	Frame 95.8" (243 cm)
Minimum Required Live Area	11' x 12.3' (3.37 m x 3.75 m)
Warranty	10 year frame and welds/1 year parts/90 days misc.

TOP VIEW

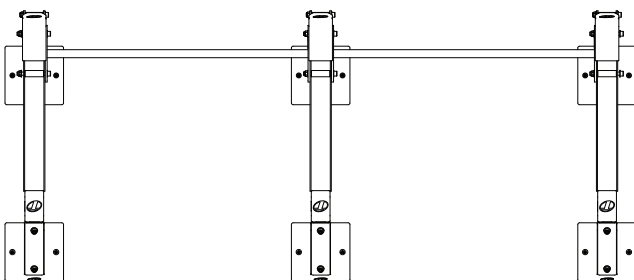

MODULE OPTIONS

- STORAGE MODULE
- BALL & HANGING STORAGE
- STALL BARS
- BALL TARGET WALL PAD
- MODULE EXTENSION

ATTACHMENT OPTIONS

- BALL TARGET
- BATTLE ROPE ANCHOR
- BALL & HANGING STORAGE EXTENSION
- GROUND ROTATIONAL TRAINER
- BAR/WEIGHT STORAGE
- DIP ATTACHMENT
- PLYO-STEP ATTACHMENT
- 3D HEAVY BAG SWIVEL
- RELENTLESS ROPE

NOTE: X-Create systems are required to be bolted to a concrete sub-floor.



Model number	XCW-3M
Footprint	36.7" x 144.1" (93 cm x 366 cm)
Height	Frame 95.8" (243 cm)
Minimum Required Live Area	11' x 16.0' (3.37 m x 4.88 m)
Warranty	10 year frame and welds/1 year parts/90 days misc.

TOP VIEW

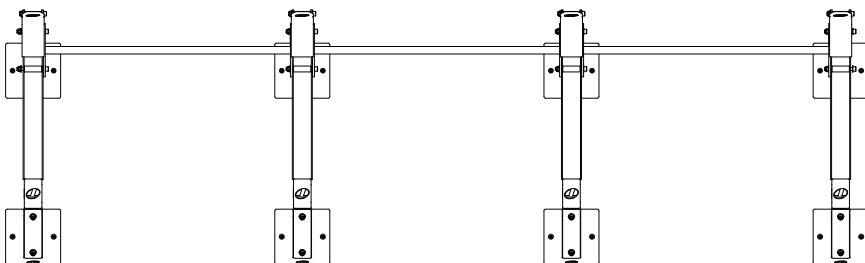

MODULE OPTIONS

- STORAGE MODULE
- BALL & HANGING STORAGE
- STALL BARS
- BALL TARGET WALL PAD
- MODULE EXTENSION

ATTACHMENT OPTIONS

- BALL TARGET
- BATTLE ROPE ANCHOR
- BALL & HANGING STORAGE EXTENSION
- GROUND ROTATIONAL TRAINER
- BAR/WEIGHT STORAGE
- DIP ATTACHMENT
- PLYO-STEP ATTACHMENT
- 3D HEAVY BAG SWIVEL
- RELENTLESS ROPE

NOTE: X-Create systems are required to be bolted to a concrete sub-floor. Accessories shown sold separately.

(4) Pull-up Stations

Urethane boots that cover anchoring hardware



UPRIGHT COLOR OPTIONS



PLATINUM



SATIN BLACK

Model number	XCW-4M
Footprint	36.7" x 189.1" (93 cm x 480 cm)
Height	Frame 95.8" (243 cm)
Minimum Required Live Area	11' x 19.8' (3.37 m x 6.04 m)
Warranty	10 year frame and welds/1 year parts/90 days misc.

TOP VIEW

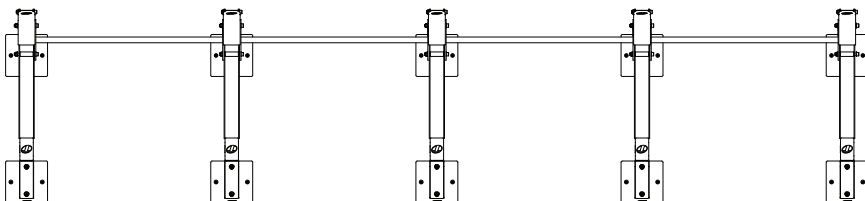

MODULE OPTIONS

- STORAGE MODULE
- BALL & HANGING STORAGE
- STALL BARS
- BALL TARGET WALL PAD
- MODULE EXTENSION

ATTACHMENT OPTIONS

- BALL TARGET
- BATTLE ROPE ANCHOR
- BALL & HANGING STORAGE EXTENSION
- GROUND ROTATIONAL TRAINER
- BAR/WEIGHT STORAGE
- DIP ATTACHMENT
- PLYO-STEP ATTACHMENT
- 3D HEAVY BAG SWIVEL
- RELENTLESS ROPE

NOTE: X-Create systems are required to be bolted to a concrete sub-floor. Accessories shown sold separately.

©2022 Torque Fitness | Toll Free 1-877-867-7835 |
sales@torquefitness.com | www.torquefitness.com

**DON'T QUIT.
EVER.™**

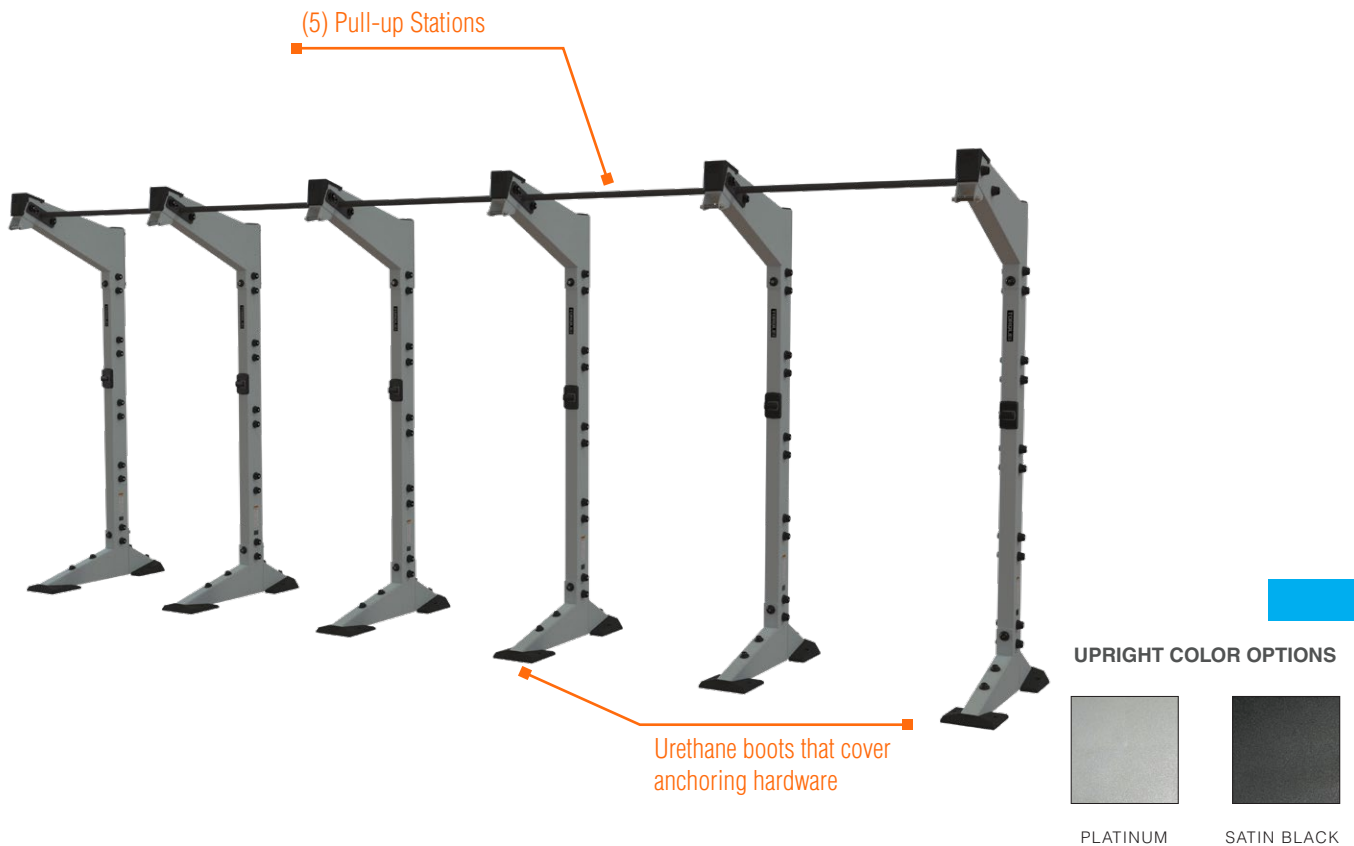

Model number	XCW-5M
Footprint	36.7" x 234.2" (93 cm x 594 cm)
Height	Frame 95.8" (243 cm)
Minimum Required Live Area	11' x 23.5' (3.37 m x 7.16 m)
Warranty	10 year frame and welds/1 year parts/90 days misc.

TOP VIEW

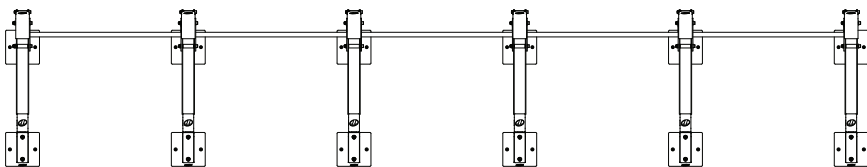

MODULE OPTIONS

- STORAGE MODULE
- BALL & HANGING STORAGE
- STALL BARS
- BALL TARGET WALL PAD
- MODULE EXTENSION

ATTACHMENT OPTIONS

- BALL TARGET
- BATTLE ROPE ANCHOR
- BALL & HANGING STORAGE EXTENSION
- GROUND ROTATIONAL TRAINER
- BAR/WEIGHT STORAGE
- DIP ATTACHMENT
- PLYO-STEP ATTACHMENT
- 3D HEAVY BAG SWIVEL
- RELENTLESS ROPE

NOTE: X-Create systems are required to be bolted to a concrete sub-floor. Accessories shown sold separately.

©2022 Torque Fitness | Toll Free 1-877-867-7835 |
sales@torquefitness.com | www.torquefitness.com

**DON'T QUIT.
EVER.™**

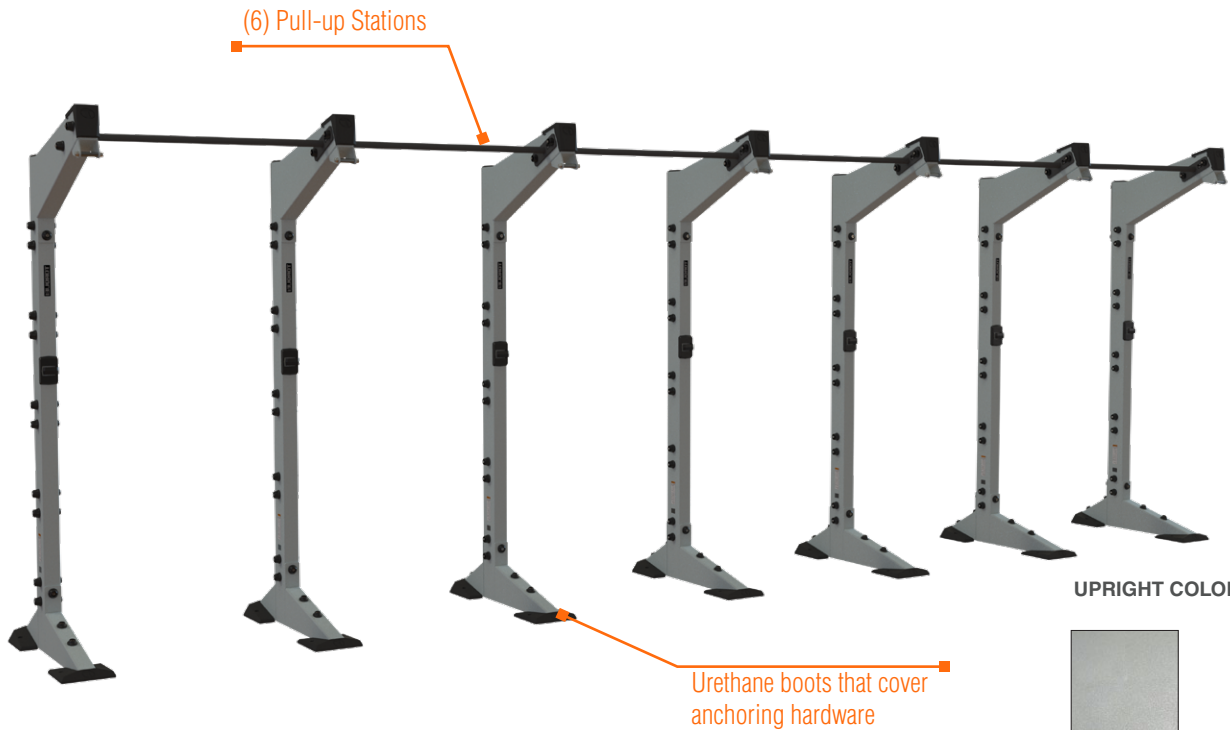

UPRIGHT COLOR OPTIONS



PLATINUM



SATIN BLACK

Model number	XCW-6M
Footprint	36.7" x 279.7" (93 cm x 710 cm)
Height	Frame 95.8" (243 cm)
Minimum Required Live Area	11' x 27.3' (3.37 m x 8.32 m)
Warranty	10 year frame and welds/1 year parts/90 days misc.

TOP VIEW

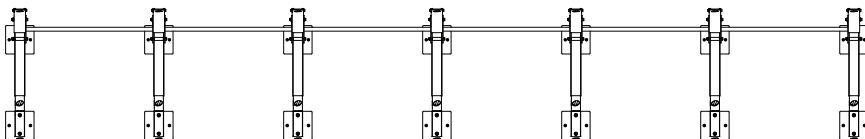

MODULE OPTIONS

- STORAGE MODULE
- BALL & HANGING STORAGE
- STALL BARS
- BALL TARGET WALL PAD
- MODULE EXTENSION

ATTACHMENT OPTIONS

- BALL TARGET
- BATTLE ROPE ANCHOR
- BALL & HANGING STORAGE EXTENSION
- GROUND ROTATIONAL TRAINER
- BAR/WEIGHT STORAGE
- DIP ATTACHMENT
- PLYO-STEP ATTACHMENT
- 3D HEAVY BAG SWIVEL
- RELENTLESS ROPE

NOTE: X-Create systems are required to be bolted to a concrete sub-floor. Accessories shown sold separately.

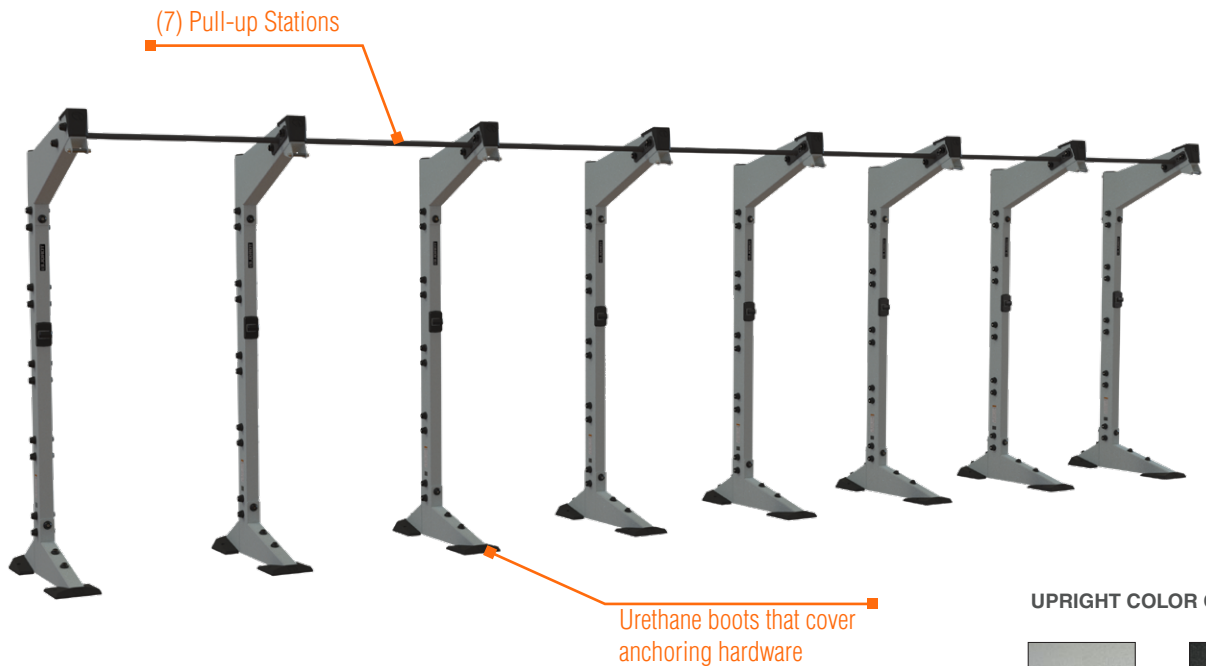

UPRIGHT COLOR OPTIONS



PLATINUM

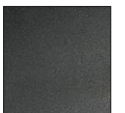

SATIN BLACK

Model number	XCW-7M
Footprint	36.7" x 324.8" (93 cm x 825 cm)
Height	Frame 95.8" (243 cm)
Minimum Required Live Area	11' x 31.1' (3.37 m x 9.48 m)
Warranty	10 year frame and welds/1 year parts/90 days misc.

TOP VIEW

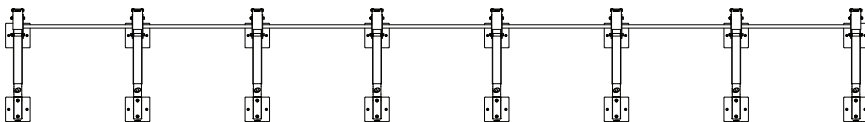

MODULE OPTIONS

- STORAGE MODULE
- BALL & HANGING STORAGE
- STALL BARS
- BALL TARGET WALL PAD
- MODULE EXTENSION

ATTACHMENT OPTIONS

- BALL TARGET
- BATTLE ROPE ANCHOR
- BALL & HANGING STORAGE EXTENSION
- GROUND ROTATIONAL TRAINER
- BAR/WEIGHT STORAGE
- DIP ATTACHMENT
- PLYO-STEP ATTACHMENT
- 3D HEAVY BAG SWIVEL
- RELENTLESS ROPE

NOTE: X-Create systems are required to be bolted to a concrete sub-floor. Accessories shown sold separately.

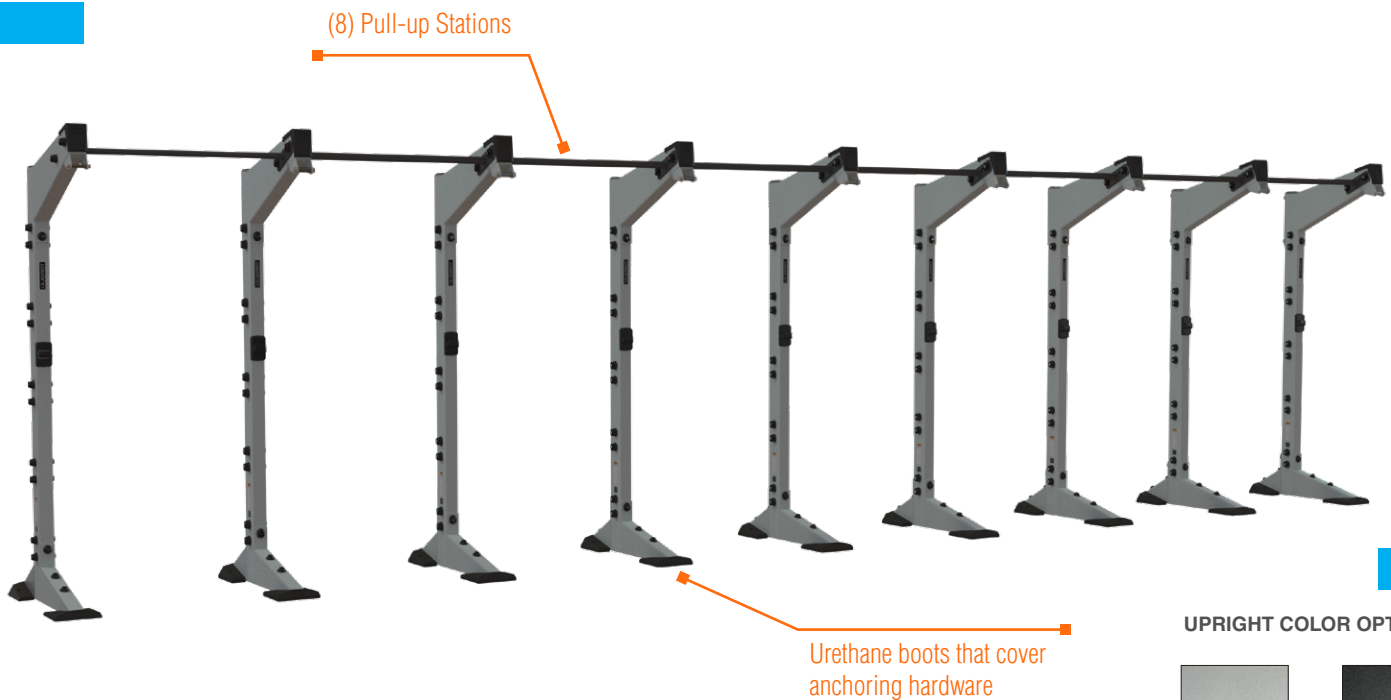

UPRIGHT COLOR OPTIONS



PLATINUM

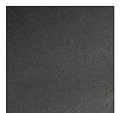

SATIN BLACK

Model number	XCW-8M
Footprint	36.7" x 369.8" (93 cm x 939 cm)
Height	Frame 95.8" (243 cm)
Minimum Required Live Area	11' x 34.8' (3.37 m x 10.61 m)
Warranty	10 year frame and welds/1 year parts/90 days misc.

TOP VIEW

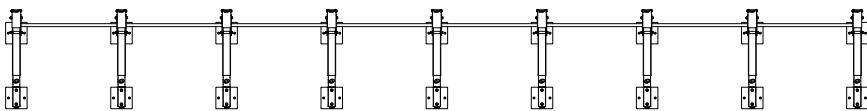

MODULE OPTIONS

- STORAGE MODULE
- BALL & HANGING STORAGE
- STALL BARS
- BALL TARGET WALL PAD
- MODULE EXTENSION

ATTACHMENT OPTIONS

- BALL TARGET
- BATTLE ROPE ANCHOR
- BALL & HANGING STORAGE EXTENSION
- GROUND ROTATIONAL TRAINER
- BAR/WEIGHT STORAGE
- DIP ATTACHMENT
- PLYO-STEP ATTACHMENT
- 3D HEAVY BAG SWIVEL
- RELENTLESS ROPE

NOTE: X-Create systems are required to be bolted to a concrete sub-floor. Accessories shown sold separately.

©2022 Torque Fitness | Toll Free 1-877-867-7835 |
sales@torquefitness.com | www.torquefitness.com

**DON'T QUIT.
EVER.™**

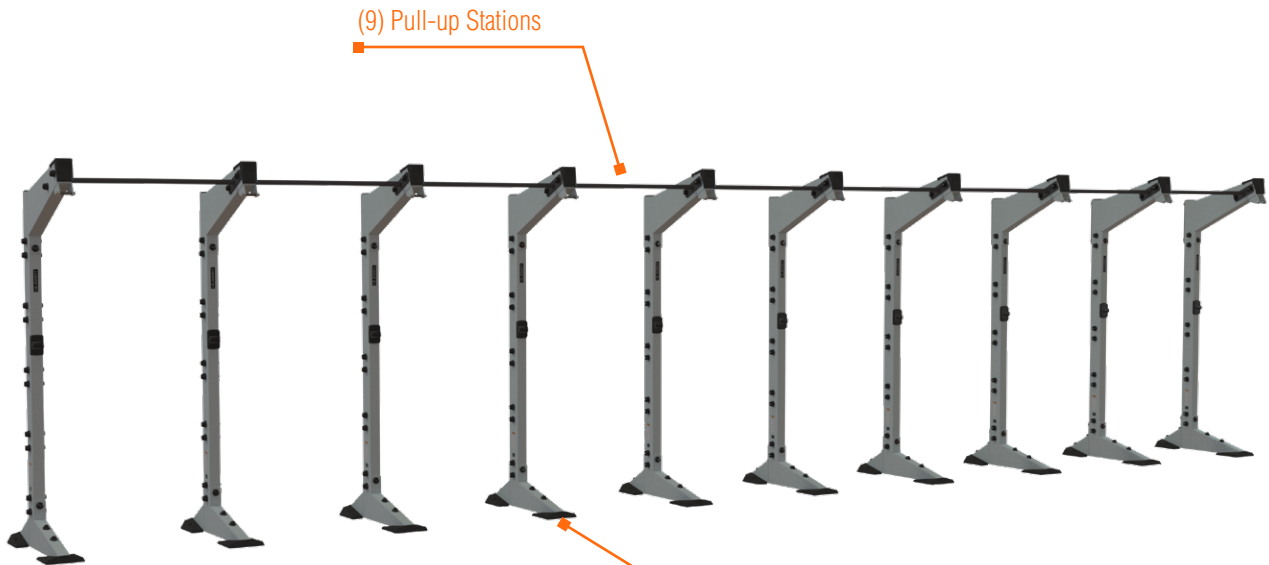

UPRIGHT COLOR OPTIONS



PLATINUM



SATIN BLACK

Model number	XCW-9M
Footprint	36.7" x 414.9" (93 cm x 1054 cm)
Height	Frame 95.8" (243 cm)
Minimum Required Live Area	11' x 38.6' (3.37 m x 11.77 m)
Warranty	10 year frame and welds/1 year parts/90 days misc.

TOP VIEW

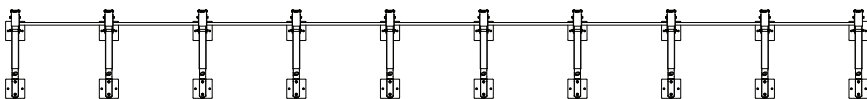

MODULE OPTIONS

- STORAGE MODULE
- BALL & HANGING STORAGE
- STALL BARS
- BALL TARGET WALL PAD
- MODULE EXTENSION

ATTACHMENT OPTIONS

- BALL TARGET
- BATTLE ROPE ANCHOR
- BALL & HANGING STORAGE EXTENSION
- GROUND ROTATIONAL TRAINER
- BAR/WEIGHT STORAGE
- DIP ATTACHMENT
- PLYO-STEP ATTACHMENT
- 3D HEAVY BAG SWIVEL
- RELENTLESS ROPE

NOTE: X-Create systems are required to be bolted to a concrete sub-floor. Accessories shown sold separately.

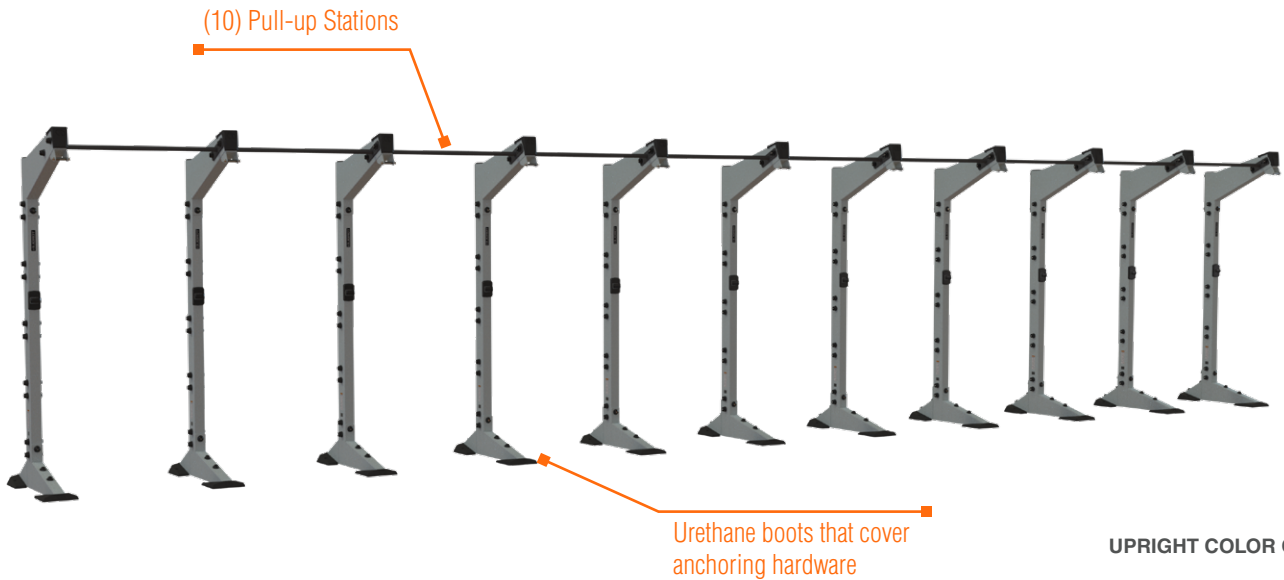

UPRIGHT COLOR OPTIONS



PLATINUM



SATIN BLACK

Model number	XCW-10M
Footprint	36.7" x 460.0" (93 cm x 1168 cm)
Height	Frame 95.8" (243 cm)
Minimum Required Live Area	11' x 42.3' (3.37 m x 12.89 m)
Warranty	10 year frame and welds/1 year parts/90 days misc.

TOP VIEW

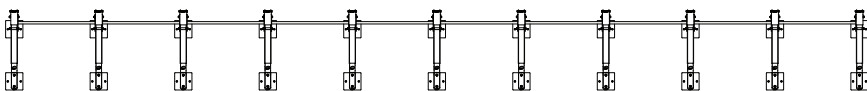

MODULE OPTIONS

- STORAGE MODULE
- BALL & HANGING STORAGE
- STALL BARS
- BALL TARGET WALL PAD
- MODULE EXTENSION

ATTACHMENT OPTIONS

- BALL TARGET
- BATTLE ROPE ANCHOR
- BALL & HANGING STORAGE EXTENSION
- GROUND ROTATIONAL TRAINER
- BAR/WEIGHT STORAGE
- DIP ATTACHMENT
- PLYO-STEP ATTACHMENT
- 3D HEAVY BAG SWIVEL
- RELENTLESS ROPE

NOTE: X-Create systems are required to be bolted to a concrete sub-floor. Accessories shown sold separately.