



OPERATING INSTRUCTIONS

P.O. Box 68323, Bryanston 2021
14 Susan Str. Strydompark. Randburg
South Africa
Tel: (011) 792-1731 Fax (011) 791-0727



HELPFUL HINTS

1. Always make sure TENT is dry when stored - away from RATS and MICE.
2. Do not wash TENT with detergent. ONLY wipe with CLEAN CLOTH.



OPERATING INSTRUCTIONS - TO OPEN

P.O. Box 68323, Bryanston 2021
200 Cussonia Park, 3 Ridge Road,
Laser Park, Honeydew, South Africa.
Tel: (011) 794-6311 • Fax: (011) 794-6233

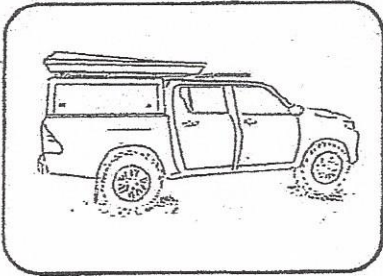

Stealth in the closed position

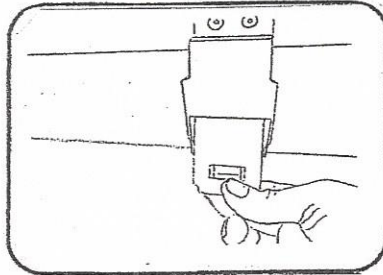

Loosen securing latch at the front end of the Stealth.

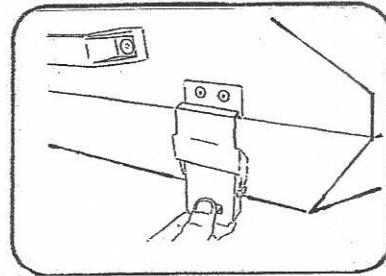

Loosen securing latches at the back of the Stealth NB (It is very important to make sure that the front securing latches have been released before lifting or the hinge mechanism may get bent in the process).

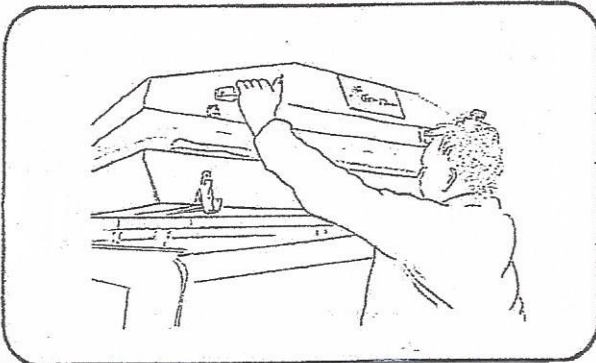

As soon as you have made absolute certain that all securing latches have been released take hold of handle and lift Stealth Lid in order to open.

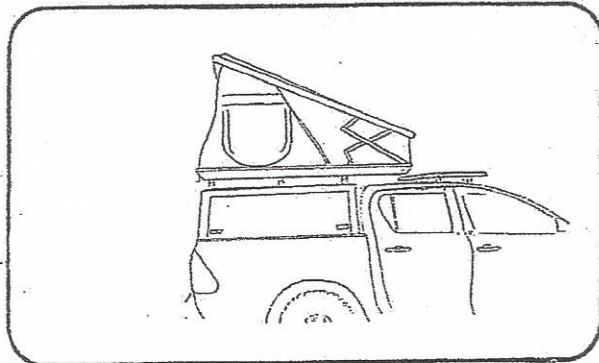

Stealth in the open position.

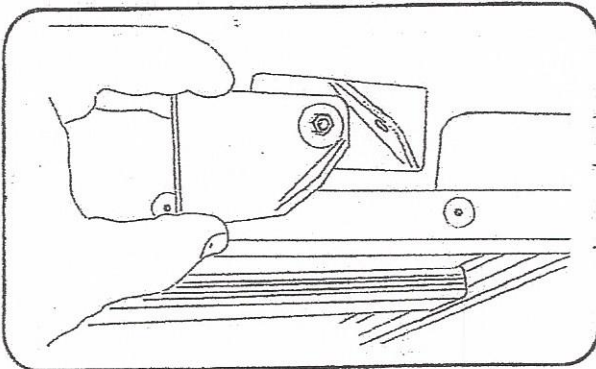

Turn ladder lock in order to gain access to ladder.

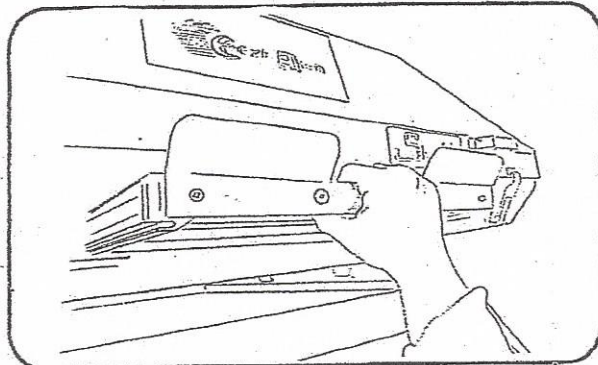

Take hold of ladder and pull and slide out.



P.O. Box 68323, Bryanston 2021
200 Cussonia Park, 3 Ridge Road,
Laser Park, Honeydew, South Africa.
Tel: (011) 794-6311 • Fax: (011) 794-6233

OPERATING INSTRUCTIONS

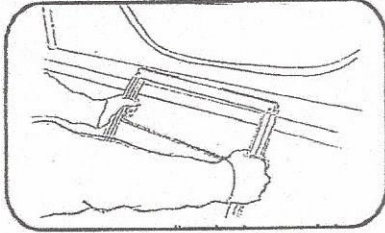

Place ladder in line with door and secure.

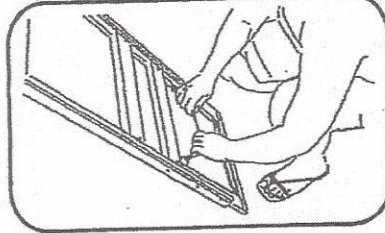

Adjust ladder foot piece to required height by pulling on the rope. Make sure pins are located before climbing up.

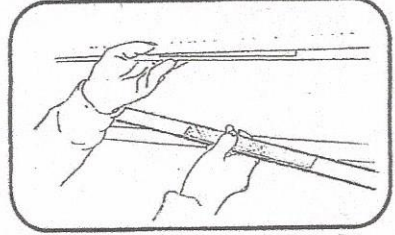

In order to deploy window arms by pulling velcro apart.

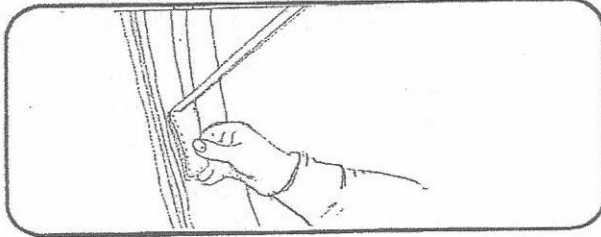

Place window arm at 45 degree angle onto Velcro next to window.

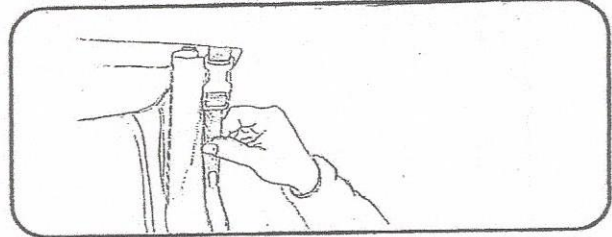

Pull down on strap to secure window arm in place.

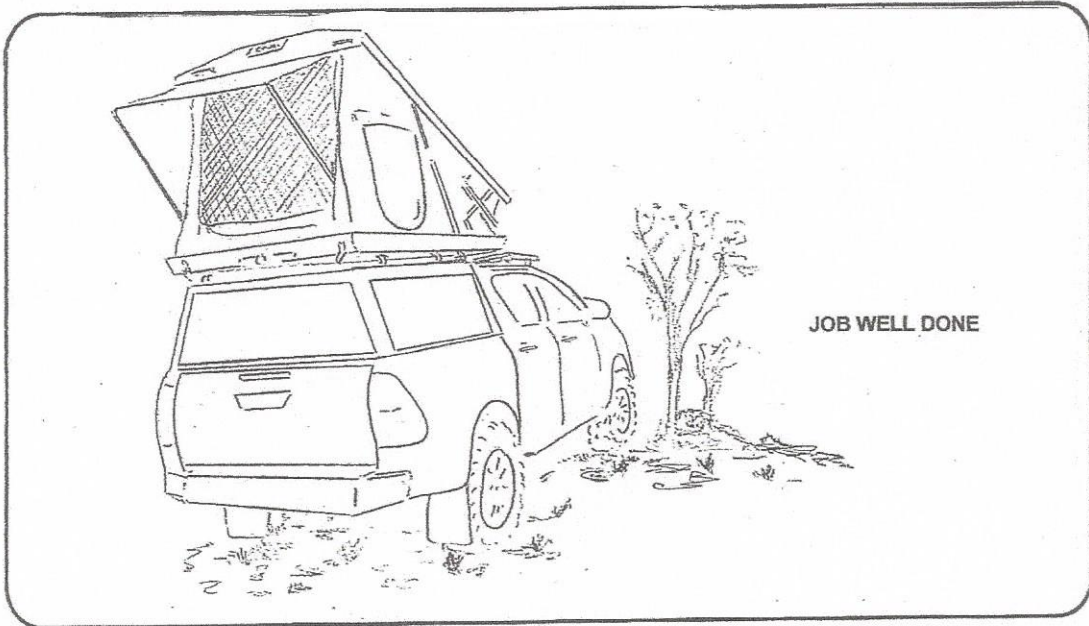

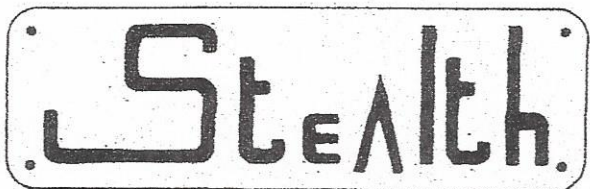

OPERATING INSTRUCTIONS - TO CLOSE

P.O. Box 68323, Bryanston 2021
200 Cussonia Park, 3 Ridge Road,
Laser Park, Honeydew, South Africa.
Tel: (011) 794-6311 • Fax: (011) 794-6233

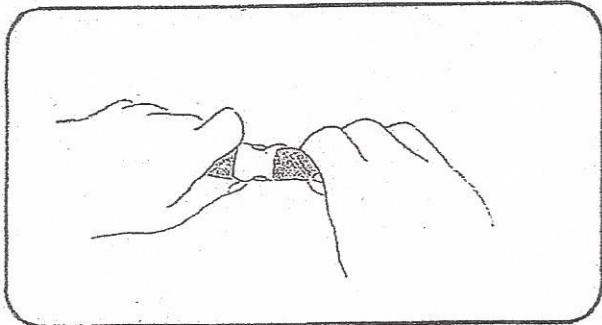

Secure all retaining straps together.

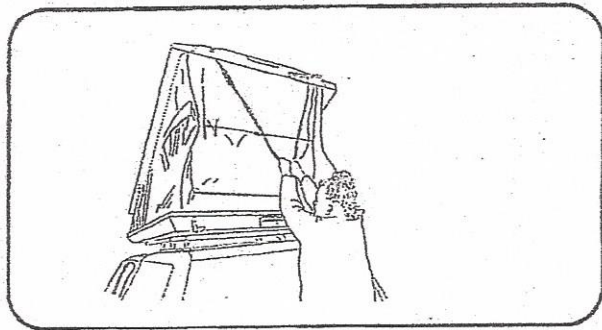

Pull down on pull strap in order to close Stealth.

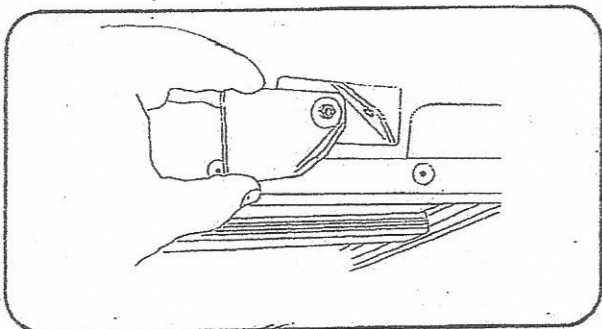

Slide ladder back into position and secure by turning ladder lock.

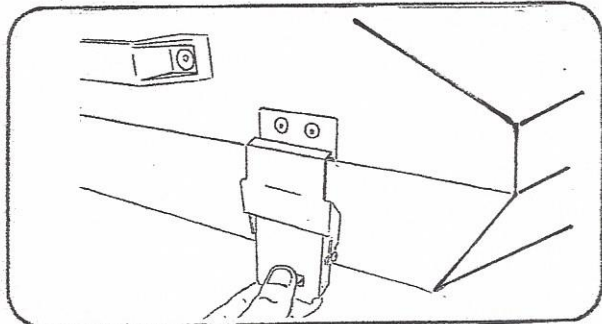

Secure latches at the back and front of the Stealth. A line locking tab with hole in securing latch with your finger.

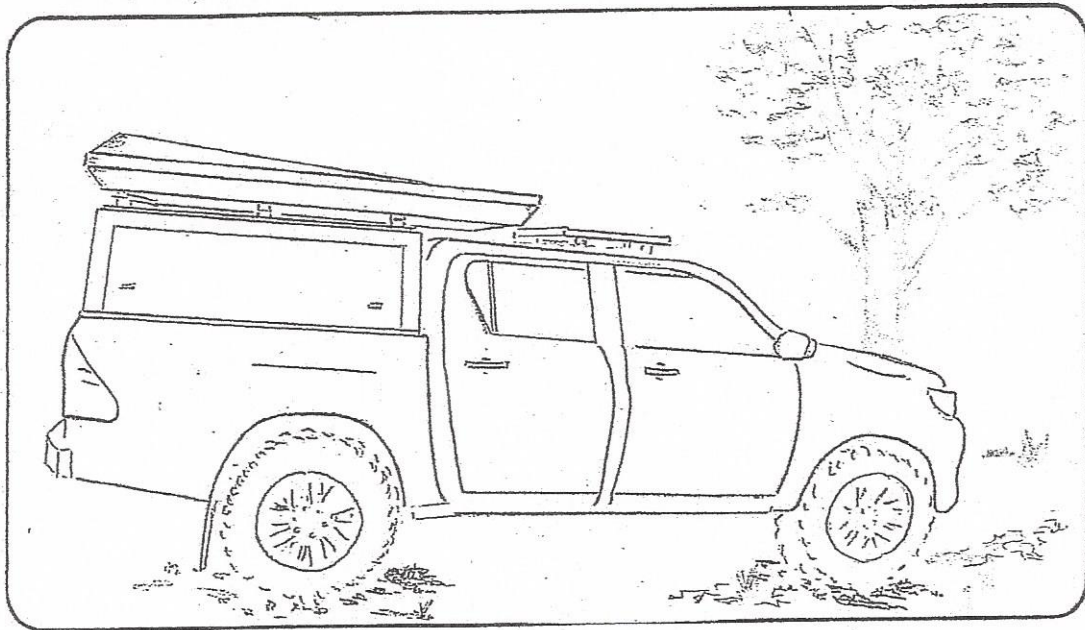

ON THE ROAD AGAIN!! - ENJOY THE RIDE!!



INSTALLATION INSTRUCTIONS

P.O. Box 68323, Bryanston 2021
14 Susan Str. Strydompark, Randburg
South Africa
Tel: (011) 792-1731 Fax (011) 791-0727

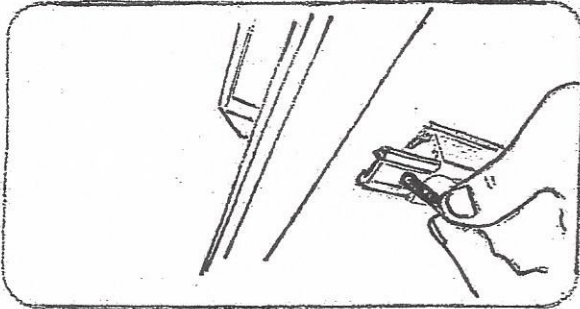

Slide fitting kit plates into tent rails and secure.

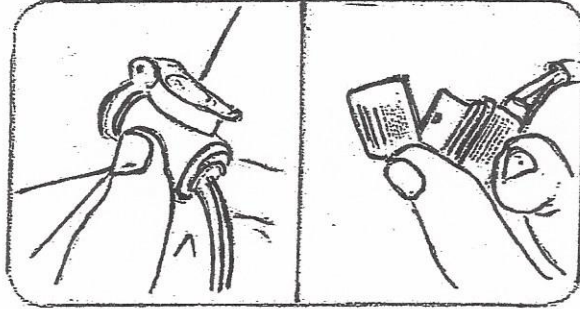

Internal Light.

If the tent is fitted with an internal light the extension cord should be connected to the tent first in order to prevent a short circuit. If a short circuit has occurred replace 15 Amp inline fuse with a new one.

PLAN VIEW ROOFTENT BASE RAIL CENTRES

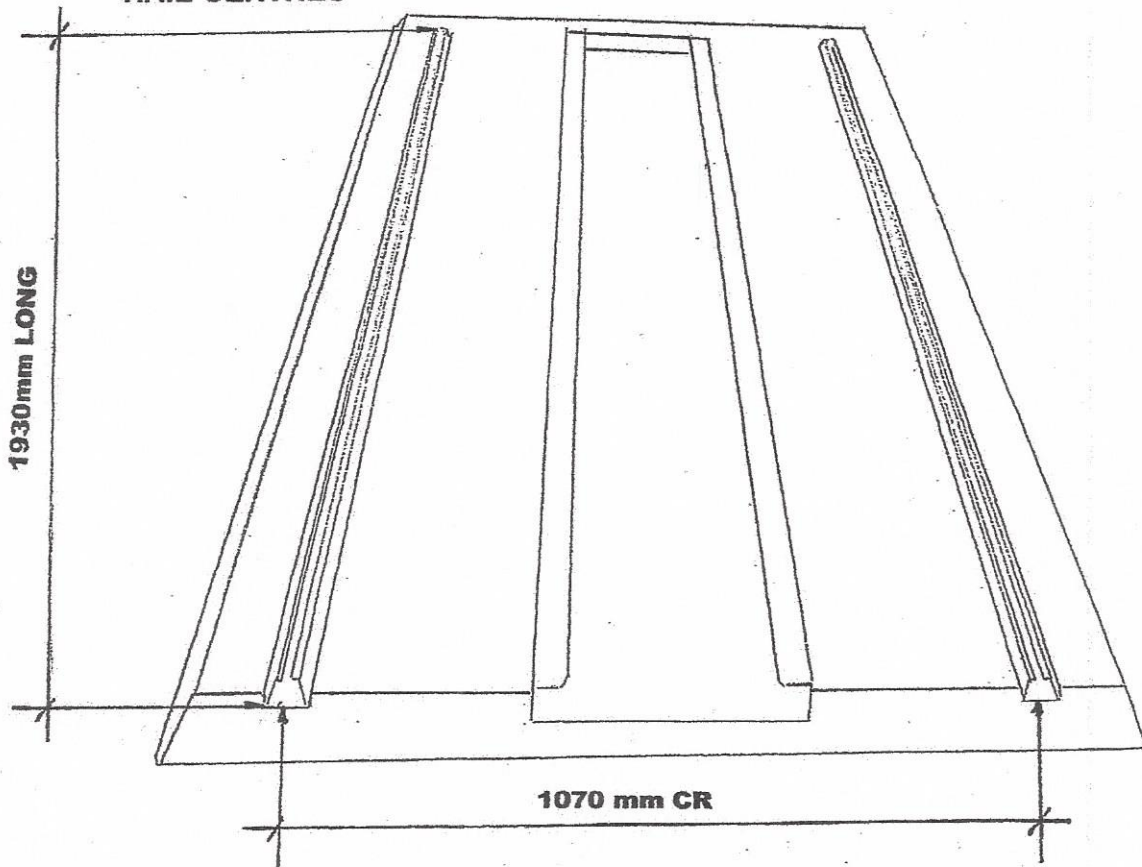

Eezi-Awn reserves the right to modify their equipment at their own discretion.