

Directional spool valves, direct operated, with solenoid actuation

Type WE

RE 23178

Edition: 2019-01

Replaces: 2013-06,
23183, 23208
and 23178-00

H7564

- ▶ Size 6
- ▶ Component series 6X
- ▶ Maximum operating pressure 350 bar [5076 psi]
- ▶ Maximum flow: 80 l/min [21 US gpm] – DC
60 l/min [15.8 US gpm] – AC



Features

- ▶ 4/3-, 4/2- or 3/2-way version
- ▶ Porting pattern according to ISO 4401-03-02-0-05 (with or without locating hole) and NFPA T3.5.1 R2-2002 D03
- ▶ High-power solenoid, optionally rotatable by 90°
- ▶ Electrical connection as individual or central connection
- ▶ Manual override, optional
- ▶ Spool position monitoring, optional
- ▶ CE conformity according to the Low-Voltage Directive 2014/35/EU for electrical voltages > 50 VAC or > 75 VDC
- ▶ Solenoid coil as approved component with UR marking according to UL 906, edition 1982, optional
- ▶ Approval according to CSA C22.2 No. 139-1982, optional

Contents

Features	1
Ordering code	2 ... 8
Symbols	9
Function, section	10
Technical data	11 ... 13
Characteristic curves	14
Performance limits	15 ... 17
Dimensions	18 ... 23
Electrical connections, assignment	24 ... 26
Accessories	27
Project planning information	28
Further information	28

Ordering code

01	02	03	04	05	06	07	08	09	10	11	12	13	14	15	16	17	18	19	20	21	
	WE	6		6X	/		E					/									*

01	3 main ports	3
	4 main ports	4
02	Directional valve	WE
03	Size 6	6
04	Symbols; possible version see page 9	
05	Component series 60 ... 69 (60 ... 69: unchanged installation and connection dimensions)	6X
06	With spring return	no code
	Without spring return	O
	Without spring return with detent	OF
07	High-power wet-pin solenoid with detachable coil	E

Electrical voltages

08	For ordering code see page 5 ... 8	e.g. G24
----	------------------------------------	-----------------

Manual override ¹⁾ (see page 20)

09	Without manual override	no code
	With manual override	N ³⁾
	With manual override "mushroom button" (small)	N2 ³⁾
	With lockable manual override "mushroom button" (small)	N4 ^{2; 3)}
	With lockable manual override "mushroom button" (large)	N5 ^{2; 3; 4)}
	With manual override "mushroom button" (large), not lockable	N6 ^{3; 4)}
	With lockable manual override "nut"	N7 ^{2; 3)}
	With concealed manual override (standard)	N9

Corrosion resistance (outside) (for the availability, refer to the following table)

10	None (valve housing primed)	no code
	Improved corrosion protection (240 h salt spray test according to EN ISO 9227)	J3
	High corrosion protection (720 h salt spray test according to EN ISO 9227)	J5

Electrical connection

11	Individual connection or central connection	
	For ordering code see page 5 ... 8	e.g. K4

¹⁾ Operation of the manual override only possible up to 50 bar [725 psi] tank pressure. Avoid damage to the bore of the manual override. (Special tool for the operation, separate order, material no. **R900024943**). If the manual override is blocked, operation of the opposite solenoid is to be excluded. The manual override cannot be allocated a safety function.

²⁾ With tank pressures higher than 50 bar, it is not guaranteed that the valve remains in the position into which it was switched by the lockable manual override ("N4", "N5", "N7").

³⁾ Only direct voltage; not for version "= UR"

⁴⁾ Only direct voltage; not for version "SO407"

Available corrosion resistance

	Electrical connection							Manual override	
	"K4"		"DL"		"K40", "C4"			Without	"N"
	"G12"	"G24"	"G24"	"G48"	"G12"	"G24"	"G26"		
"J3"	✓	✓	✓	✓	-	-	-	✓	✓
"J5"	-	-	-	-	✓	✓	✓	✓	✓

Ordering code

01	02	03	04	05	06	07	08	09	10	11	12	13	14	15	16	17	18	19	20	21	
	WE	6		6X	/		E					/									*

Spool position monitoring (For more information, see data sheet 24830)

12	Without position switch	no code
	– Inductive position switch type QM (valves with 2 spool positions)	
	Monitored spool position "a"	QMAG24
	Monitored spool position "b"	QMBG24
	Monitored rest position	QM0G24
	– Inductive position switch type QR (valves with 3 spool positions)	
	Monitored rest position	QR0G24S
	Monitored spool position "a" and "b"	QRABG24E
	– Inductive position switch type QS	
	Monitored spool position "a"	QSAG24W
	Monitored spool position "b"	QSBG24W
	Monitored spool position "0"	QS0G24W
	Monitored spool position "0" and "a"	QS0AG24W
	Monitored spool position "0" and "b"	QS0BG24W
	Monitored spool position "a" and "b"	QSABG24W

Switching time increase

13	Without switching time increase	no code
	With switching time increase (only with direct voltage and only with version "N9" and symbol "73")	A12

Throttle insert

14	Without throttle insert (standard)	no code								
	With throttle insert (when the admissible valve performance limit is exceeded, refer to page 15 ... 17):									
	Port	Throttle Ø in mm [inch]								
		0.6 [0.024]	0.8 [0.031]	1.0 [0.039]	1.2 [0.047]	1.5 [0.059]	2.0 [0.079]	2.5 [0.098]	3.0 [0.120]	4.0 [0.160]
	P	= B06	= B08	= B10	= B12	= B15	= B20	= B25	= B30	= B40
	A	= H06	= H08	= H10	= H12	= H15	= H20	= H25	= H30	= H40
	B	= R06	= R08	= R10	= R12	= R15	= R20	= R25	= R30	= R40
	A and B	= N06	= N08	= N10	= N12	= N15	= N20	= N25	= N30	= N40
	T	= X06	= X08	= X10	= X12	= X15	= X20	= X25	= X30	= X40

Clamping length

15	42 mm [1.65 inch] (standard)	no code
	22 mm [0.87 inch]	Z

Control spool play

16	Standard (recommended)	no code
	Minimum (selection for reduced leakage values; higher oil cleanliness required)	T06
	Increased (selection with high temperature difference hydraulic fluid/environment; leads to higher internal leakage values)	T12

Seal material (observe compatibility of seals with hydraulic fluid used, see page 12)

17	NBR seals	no code
	FKM seals	V
	Recommended for operation with HFC hydraulic fluids together with high temperatures	MH
	Low-temperature version (only with version "Without manual override")	MT

Ordering code

01	02	03	04	05	06	07	08	09	10	11	12	13	14	15	16	17	18	19	20	21
	WE	6		6X	/		E					/								*

18	Standard	no code
	Solenoid coil as approved component with UR marking according to UL 906, edition 1982 ⁵⁾	= UR
	Approval according to CSA C22.2 No. 139-1982	= CSA
	Porting pattern according to ANSI B93.9 ⁶⁾	= AN
19	Without locating hole	no code
	With locating hole and locking pin ISO 8752-3x8-St	/62
20	Standard	no code
	With reduced electric power consumption (only versions "G24" as well as "K4", "DL" and "DKL")	SO407
21	Further details in the plain text	*

⁵⁾ Only for version "K4" with "G12", "G24" and "W110"

⁶⁾ With power supply to

- ▶ solenoid "a", channel P is connected to a
- ▶ solenoid "b", channel P is connected to B

Ordering code: DC voltage – individual connection**Electrical connections and available voltages**

(special voltages upon request)

Connector	Ordering code	Electrical voltages									Protection class according to DIN EN 60529 ¹⁾	Protection class according to VDE 0580	
		12 V	24 V	26 V	48 V	96 V	110 V	125 V	205 V	220 V			
		G12	G24	G26	G48	G96	G110	G125	G205	G220			
Connector 3-pole (2 + PE) according to DIN EN 175301-803	<ul style="list-style-type: none"> ▶ Standard ▶ With potted-in plug base and sealing element 	K4	✓	✓	-	✓	✓	✓	✓	✓	✓	IP65	I ²⁾
		K4K	✓	✓	✓	-	-	-	-	-	-	IP65	I ²⁾
Connector 2-pole, DT04-2PA (Deutsch type)		K40	✓	✓	✓	-	-	-	-	-	-	IP69K	III ³⁾
Connector, 4-pole, M12x1 according to DIN EN 61076-2-101 with suppressor diode, coding A	<ul style="list-style-type: none"> ▶ Pin assignment according to DESINA ▶ Standard 	K72L	-	✓	-	-	-	-	-	-	-	IP65	III ³⁾
		K73L	-	✓	-	-	-	-	-	-	-	IP65	III ³⁾
Connector 2-pole (Junior-Timer type)	▶ Connector parallel to the valve axis	C4	✓	✓	✓	-	-	-	-	-	-	IP66	III ³⁾
Maximum admissible overvoltages according to DIN EN 60664-1:2008-01 (VDE 0110-1) (overvoltage category II):													
Nominal voltage U_{Nom}	in V	12	24	26	48	96	110	125	205	220			
Rated current I_{Nom}	in A	2.5	1.25	1.17	0.66	0.33	0.25	0.17	0.16	0.14			
Maximum admissible switch-off overvoltage according to VDE 0580	in V	500	500	500	500	500	500	500	500	500			
Recommended interference protection circuit with 2 x mains voltage	in V	24	48	52	96	192	220	250	410	440			

- 1) Only with correctly mounted valve with a mating connector suitable for the protection class.
- 2) Protection class I with properly connected protective grounding conductor (PE) and valve mounting surface connected to the protective grounding conductor system.
- 3) With protection class III, a protective extra-low voltage with isolation transformer (PELV, SELV) is to be provided.

Notice:

Solenoid valves induce voltage peaks during switch-off. In order to prevent electro-magnetic interference at the system and damage to the valve control, an interference protection circuit has to be provided on the system side. Alternatively, you can also select a connector with integrated interference protection circuit.

Ordering code: Direct voltage – central connection**Electrical connections and available voltages**

(special voltages upon request)

Connector		Ordering code	Electrical voltages							Protection class according to DIN EN 60529 ¹⁾	Protection class according to VDE 0580
			12 V	24 V	48 V	96 V	110 V	125 V	220 V		
			G12	G24	G48	G96	G110	G125	G220		
Cable gland, terminal area 6 ... 12 mm [0.23... 0.47 inch]	▶ With indicator light	DL	✓	✓	✓	✓	✓	✓	✓	IP65	I ²⁾
	▶ With indicator light and interference protection circuit	DL1	✓	✓	✓	✓	✓	✓	✓	IP65	I ²⁾
Cable gland, threaded connection 1/2"-14 NPT	▶ With indicator light	DAL	✓	✓	-	-	-	✓	-	IP65	I ²⁾
	▶ With indicator light and interference protection circuit	DAL1	✓	✓	-	-	-	✓	-	IP65	I ²⁾
Connector 7-pole (6 + PE) according to DIN EN 175201-804	▶ With indicator light	DK6L	-	✓	✓	-	✓	✓	✓	IP65	I ²⁾
	▶ With indicator light and interference protection circuit	DK6L1	-	✓	✓	-	✓	✓	✓	IP65	I ²⁾
Connector according to ANSI/B93.55M-1981 (Brad Harrison Mini-Change)	▶ With indicator light, 3-pole	DK23L	-	✓	-	-	-	-	-	IP65	I ²⁾
	▶ With indicator light, 5-pole	DK25L	-	✓	-	-	-	-	-	IP65	I ²⁾
Connector, 4-pole, M12x1 according to DIN EN 61076-2-101	▶ With indicator light	DK24L	-	✓	-	-	-	-	-	IP65	III ³⁾
	▶ With indicator light and interference protection circuit	DK24L1	-	✓	-	-	-	-	-	IP65	III ³⁾
	▶ With indicator light and interference protection circuit	DK35L	-	✓	-	-	-	-	-	IP65	III ³⁾
Maximum admissible overvoltages according to DIN EN 60664-1:2008-01 (VDE 0110-1) (overvoltage category II):											
Nominal voltage U_{Nom}	in V		12	24	48	96	110	125	220		
Rated current I_{Nom}	in A		2.5	1.25	0.66	0.33	0.25	0.17	0.14		
Maximum admissible switch-off overvoltage according to VDE 0580	in V		500	500	500	500	500	500	500		
Recommended interference protection circuit with 2 x mains voltage	in V		24	48	96	192	220	250	440		

- ¹⁾ Only with correctly mounted valve with a mating connector suitable for the protection class or suitable Conduit system.
- ²⁾ Protection class I with properly connected protective grounding conductor (PE) and valve mounting surface connected to the protective grounding conductor system.
- ³⁾ With protection class III, a protective extra-low voltage with isolation transformer (PELV, SELV) is to be provided.

Notice:

Solenoid valves induce voltage peaks during switch-off. In order to prevent electro-magnetic interference at the system and damage to the valve control, an interference protection circuit has to be provided on the system side. Alternatively, you can also select a connector with integrated interference protection circuit.

Ordering code: Alternating voltage – individual connection**Electrical connections and available voltages**

(special voltages upon request)

Connector	Ordering code	Electrical voltages										Protection class according to DIN EN 60529 ¹⁾	Protection class according to VDE 0580
		100 V 50/60 Hz	100 V 50/60 Hz	110 V 50/60 Hz	110 V 50/60 Hz	120 V 60 Hz	120 V 60 Hz	200 V 50 Hz	200 V 50 Hz	230 V 50/60 Hz	230 V 50/60 Hz		
		Ordering code											
		G96	W100	G96	W110	G110	W110	G180	W200	G205	W230		
Connector 3-pole (2 + PE) according to DIN EN 175301-803	K4	✓	✓	✓	✓	✓	✓	✓	✓	✓	✓	IP65	1 ²⁾
Rectifier required (see page 27)		✓	-	✓	-	✓	-	✓	-	✓	-		
Maximum admissible overvoltages according to DIN EN 60664-1:2008-01 (VDE 0110-1) (overvoltage category II):													
Nominal voltage U_{Nom}	in V	100	100	110	110	120	120	200	200	230	230		
Rated current I_{Nom}	▶ 50 Hz	in A	0.31	0.56	0.34	0.52	-	-	0.18	0.29	0.16	0.23	
	▶ 60 Hz	in A	0.31	0.44	0.34	0.39	0.30	0.45	-	-	0.16	0.17	
Lower rated current I_1	▶ 50 Hz	in A	-	0.65	-	0.6	-	-	-	0.33	-	0.27	
	▶ 60 Hz	in A	-	0.51	-	0.45	-	0.52	-	-	-	0.2	
Upper rated current I_2	▶ 50 Hz	in A	-	0.9	-	0.9	-	-	-	0.6	-	0.36	
	▶ 60 Hz	in A	-	0.9	-	0.6	-	0.9	-	-	-	0.36	
Maximum admissible switch-off overvoltage according to VDE 0580	in V	500	500	500	500	500	500	500	500	500	500		
Recommended interference protection circuit with 2 x mains voltage	in V	200	200	220	220	240	240	400	400	460	460		

- 1) Only with correctly mounted valve with a mating connector suitable for the protection class.
- 2) Protection class I with properly connected protective grounding conductor (PE) and valve mounting surface connected to the protective grounding conductor system.

Notes:

- ▶ Solenoid valves induce voltage peaks during switch-off. In order to prevent electro-magnetic interference at the system and damage to the valve control, an interference protection circuit has to be provided on the system side. Alternatively, you can also select a connector with integrated interference protection circuit.
- ▶ Depending on the rated current I_{Nom} , circuit breakers according to tripping characteristic "K" are to be provided. The tripping current must lie within a time interval of 0.6 s with 8 to 10 times the nominal power supply. The required non-tripping current of the fuse must not fall below the "lower rated current" value I_1 (see preceding table). The maximum tripping current must not exceed the "upper rated current" value I_2 (see preceding table). The temperature dependence of the tripping behavior of the circuit breakers has to be considered according to the manufacturer's specifications.

Ordering code: Alternating voltage – central connection**Electrical connections and available voltages**

(special voltages upon request)

Connector		Ordering code	Electrical voltages							Protection class according to DIN EN 60529 ¹⁾	Protection class according to VDE 0580	
			100 V 50/60 Hz	110 V 50/60 Hz	110 V 50/60 Hz	120 V 60 Hz	120 V 60 Hz	200 V 50 Hz	230 V 50/60 Hz			230 V 50/60 Hz
			W100	W110R	W110	W120R	W110	W200	W230R			W230
Cable gland, terminal area 6 ... 12 mm	▶ With indicator light	DL	✓	✓	✓	✓	✓	✓	✓	✓	IP65	1 ²⁾
	▶ With indicator light and interference protection circuit	DL1	✓	✓	✓	✓	✓	✓	✓	✓	IP65	1 ²⁾
	▶ With indicator light and interference protection circuit ³⁾	DJL	✓	-	-	-	-	✓	-	-	IP65	1 ²⁾
Cable gland, threaded connection 1/2"-14 NPT	▶ With indicator light	DAL	✓	✓	✓	✓	✓	-	✓	✓	IP65	1 ²⁾
	▶ With indicator light and interference protection circuit	DAL1	-	✓	✓	✓	✓	-	✓	✓	IP65	1 ²⁾
Connector 7-pole (6 + PE) according to DIN EN 175201-804	▶ With indicator light	DK6L	-	✓	✓	✓	✓	-	-	-	IP65	1 ²⁾
	▶ With indicator light and interference protection circuit	DK6L1	-	✓	✓	✓	✓	-	-	-	IP65	1 ²⁾
Connector according to ANSI/B93.55M-1981 (Brad Harrison Mini-Change)	▶ With indicator light, 3-pole	DK23L	-	✓	✓	✓	✓	-	-	-	IP65	1 ²⁾
	▶ With indicator light, 5-pole	DK25L	-	✓	✓	✓	✓	-	-	-	IP65	1 ²⁾
Maximum admissible overvoltages according to DIN EN 60664-1:2008-01 (VDE 0110-1) (overvoltage category II):												
Nominal voltage U_{Nom}	in V		100	110	110	120	120	200	230	230		
Rated current I_{Nom}	▶ 50 Hz	in A	0.56	0.34	0.52	-	-	0.29	0.16	0.23		
	▶ 60 Hz	in A	0.44	0.34	0.39	0.30	0.45	-	0.16	0.17		
Lower rated current I_1	▶ 50 Hz	in A	0.65	-	0.6	-	-	0.33	-	0.27		
	▶ 60 Hz	in A	0.51	-	0.45	-	0.52	-	-	0.2		
Upper rated current I_2	▶ 50 Hz	in A	0.9	-	0.9	-	-	0.6	-	0.36		
	▶ 60 Hz	in A	0.9	-	0.6	-	0.9	-	-	0.36		
Maximum admissible switch-off overvoltage according to VDE 0580	in V		500	500	500	500	500	500	500	500		
Recommended interference protection circuit with 2 x mains voltage	in V		200	220	220	220	240	400	460	460		

- 1) Only with correctly mounted valve with a mating connector suitable for the protection class or suitable Conduit system.
- 2) Protection class I with properly connected protective grounding conductor (PE) and valve mounting surface connected to the protective grounding conductor system.
- 3) Wire bridge between pin 2- and 4-.

Notice:

- ▶ Solenoid valves induce voltage peaks during switch-off. In order to prevent electro-magnetic interference at the system and damage to the valve control, an interference protection circuit has to be provided on the system side. Alternatively, you can also select a connector with integrated interference protection circuit.
- ▶ Depending on the rated current I_{Nom} , circuit breakers according to tripping characteristic "K" are to be provided. The tripping current must lie within a time interval of 0.6 s with 8 to 10 times the nominal power supply. The required non-tripping current of the fuse must not fall below the "lower rated current" value I_1 (see preceding table). The maximum tripping current must not exceed the "upper rated current" value I_2 (see preceding table). The temperature dependence of the tripping behavior of the circuit breakers has to be considered according to the manufacturer's specifications.

Symbols

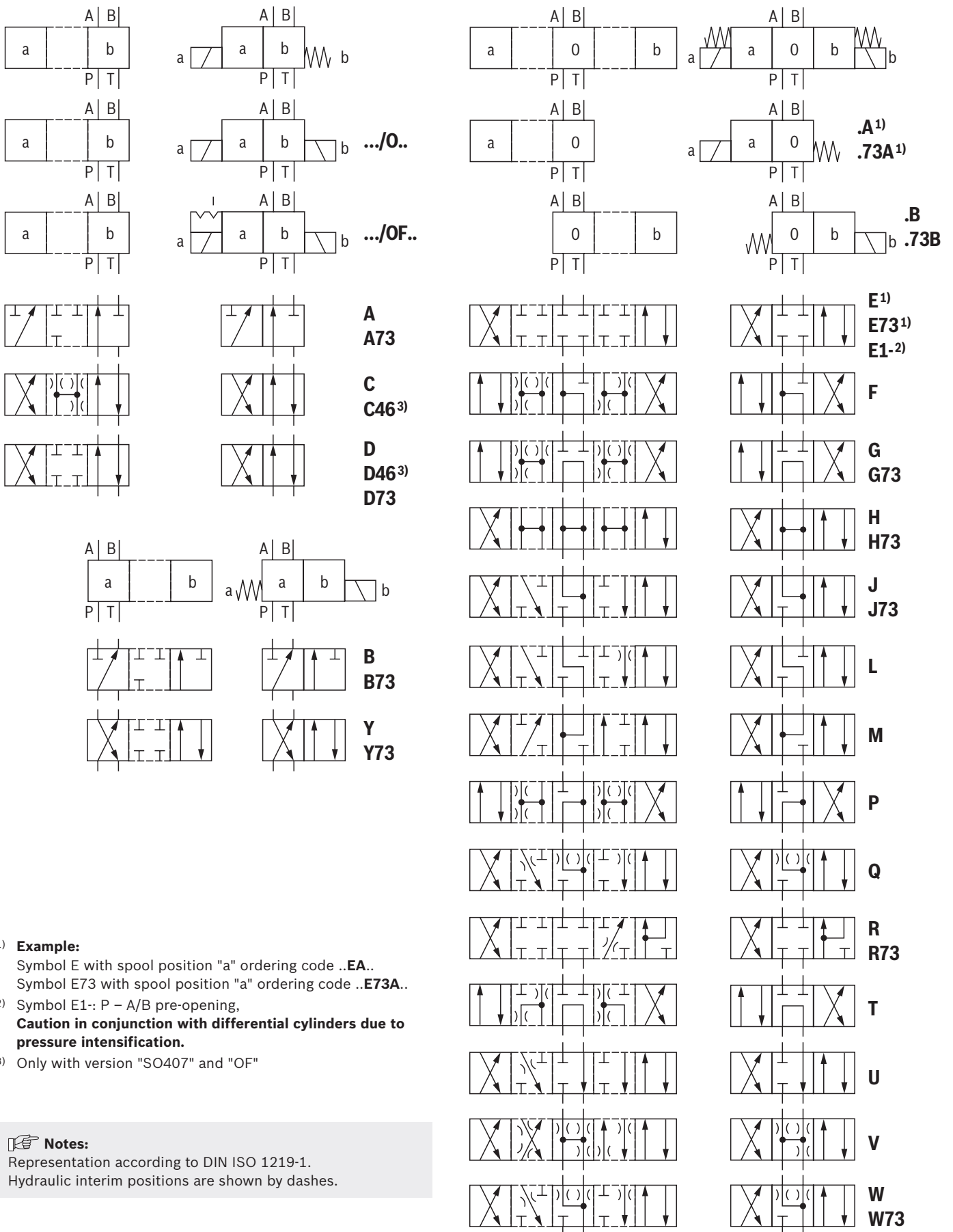

- 1) **Example:**
 Symbol E with spool position "a" ordering code **..EA..**
 Symbol E73 with spool position "a" ordering code **..E73A..**
- 2) Symbol E1-: P – A/B pre-opening,
Caution in conjunction with differential cylinders due to pressure intensification.
- 3) Only with version "SO407" and "OF"

Notes:

Representation according to DIN ISO 1219-1.
 Hydraulic interim positions are shown by dashes.

Function, section

The directional valves of type WE are solenoid-actuated directional spool valves that can be used as electro-magnetic component. They control start, stop and direction of a flow.

The directional valves basically consist of the housing (1), one or two electronic solenoids (2), the control spool (3), and the return springs (4).

In the de-energized condition, the control spool (3) is held in the central position or in the initial position by the return springs (4) (except for version "O").

If the wet-pin electronic solenoid (2) is supplied with power, the control spool (3) moves out of its rest position into the required end position. In this way, the required direction of flow according to the selected symbol is released.

After the electronic solenoid (2) has been switched off, the control spool (3) is pushed back into its central position or into its initial position (except for valves with "OF" detent and valves without type "O" spring).

A manual override (5) allows for the manual switching of the valve without solenoid energization.

For unobjectionable functioning, the hydraulic system has to be bled properly.

Without spring return "O" (only possible with symbols A, C and D)

This version is a directional valve with two spool positions and two electronic solenoids **without** detent. The valve without spring return at the control spool (3) has no defined basic position in the de-energized condition.

Without spring return with "OF" detent (only possible with symbols A, C and D)

This version is a directional valve with two spool positions and two electronic solenoids **with** detent. The detents are used to fix the control spool (3) in the relevant spool position. During operation, continuous application of current to the electronic solenoid can thus be omitted which contributes to energy-efficient operation.

Version ".73...A12" (smooth switching behavior)

By means of structural design of the control spools and solenoids, switching shocks occurring when activating and deactivating the valves are significantly reduced.

The switching shocks, measured as acceleration values **a**, can be reduced by up to approx. 85% when compared to the standard valve depending on the design of the control spool (for this, see "Acceleration values" on page 13).

Notes:

Pressure peaks in the tank line to two or several valves can result in unintended movements of the control spool in the case of version with detent. We therefore recommend that separate return lines be provided or a check valve installed in the tank line.

Due to the design principle, internal leakage is inherent to the valves, which may increase over the life cycle.

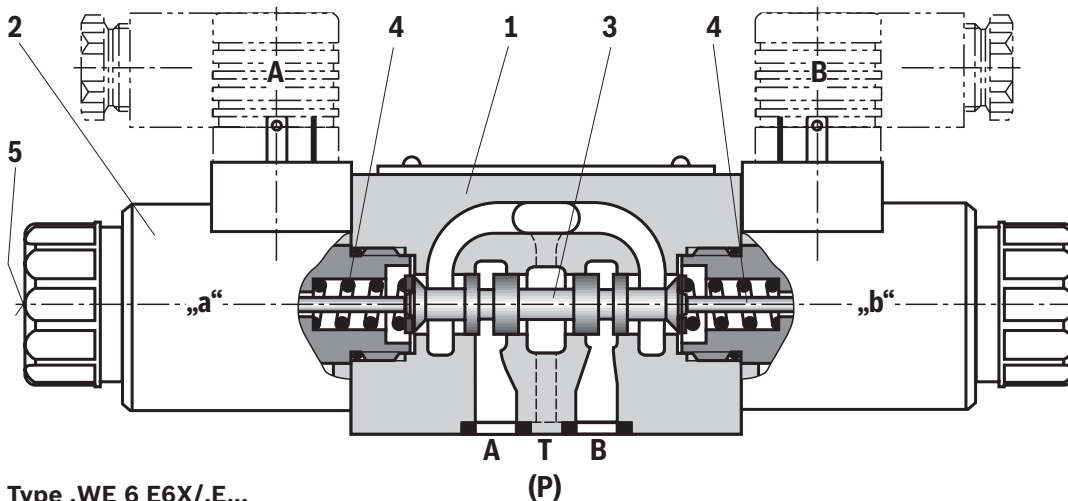

Type .WE 6 E6X/.E...

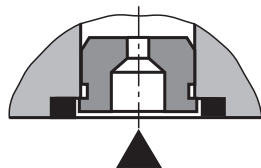

Throttle insert

The use of a throttle insert is required when, due to prevailing operating conditions, flows occur during the switching processes which exceed the performance limit of the valve.

Technical data

(For applications outside the stated values, please ask us!)

general			
Weight	▶ Valve with one solenoid	kg [lbs]	1.45 [3.2]
	▶ Valve with two solenoids	kg [lbs]	1.95 [4.3]
Installation position			any
Ambient temperature range	▶ Standard version	°C [°F]	-20 ... +50 [-4 ... +122] (NBR seals) -15 ... +50 [+5 ... +122] (FKM seals)
	▶ Version for HFC hydraulic fluid	°C [°F]	-20 ... +50 [-4 ... +122]
	▶ Low-temperature version ¹⁾	°C [°F]	-40 ... +50 [-40 ... +122]
Storage temperature range		°C [°F]	+5 ... +40 [41 ... +104]
MTTF _D values according to EN ISO 13849		Years	300 (for further details see data sheet 08012)

hydraulic			
Maximum operating pressure	▶ Port A, B, P		
	– Standard version	bar [psi]	350 [5076]
	– Version "SO407"	bar [psi]	315 [4550]
	▶ Port T	bar [psi]	210 [3050] (DC); 160 [2320] (AC) With symbols A and B, port T must be used as leakage oil connection if the operating pressure exceeds the maximum admissible tank pressure.
Maximum flow	▶ Direct voltage DC		
	– Standard version	l/min [US gpm]	80 [21]
	– Version "SO407"	l/min [US gpm]	60 [15.8]
	▶ Alternating voltage AC	l/min [US gpm]	60 [15.8]
Flow cross-section (spool position 0)	▶ Symbol Q	mm ²	approx. 6% of nominal cross-section
	▶ Symbol W	mm ²	approx. 3% of nominal cross-section
Hydraulic fluid			see table page 12
Hydraulic fluid temperature range (at the valve working ports)		°C [°F]	-20 ... +80 [-4 ... +176] (NBR seals) -15 ... +80 [+5 ... +176] (FKM seals) -20 ... +50 [-4 ... +122] (HFC hydraulic fluid) -40 ... +50 [-40 ... +122] (low-temperature version)
Viscosity range		mm ² /s [SUS]	2.8 ... 500 [35 ... 2320]
Maximum admissible degree of contamination of the hydraulic fluid; cleanliness class according to ISO 4406 (c)			Class 20/18/15 ²⁾

¹⁾ In case of use at low temperatures, see project planning information on page 28.

²⁾ The cleanliness classes specified for the components must be adhered to in hydraulic systems. Effective filtration prevents faults and simultaneously increases the life cycle of the components.

Available filters can be found at www.boschrexroth.com/filter.

Technical data

(For applications outside the stated values, please ask us!)

Hydraulic fluid	Classification	Suitable sealing materials	Standards	Data sheet
Mineral oils	HL, HLP, HLPD, HVLP, HVLPD	NBR, FKM	DIN 51524	90220
Bio-degradable	▶ Insoluble in water	HETG	ISO 15380	90221
		HEES		
	▶ Soluble in water	HEPG	ISO 15380	
Flame-resistant	▶ Water-free	HFDD (glycol base)	ISO 12922	90222
		HFDD (ester base)		
		HFDR		
	▶ Containing water	HFC (Fuchs: Hydrotherm 46M, Fuchs Renosafe 500; Petrofer: Ultra Safe 620; Houghton: Safe 620; Union: Carbide HP5046)	NBR	ISO 12922



Important notices on hydraulic fluids:

- ▶ For further information and data on the use of other hydraulic fluids, please refer to the data sheets above or contact us.
- ▶ There may be limitations regarding the technical valve data (temperature, pressure range, life cycle, maintenance intervals, etc.).
- ▶ The ignition temperature of the hydraulic fluid used must be 50 K higher than the maximum surface temperature.
- ▶ **Bio-degradable and flame-resistant – containing water:** If this hydraulic fluid is used, small amounts of dissolved zinc may get into the hydraulic system.

▶ Flame-resistant – containing water:

- Due to increased cavitation tendency with HFC hydraulic fluids, the life cycle of the component may be reduced by up to 30% as compared to the use with mineral oil HLP. In order to reduce the cavitation effect, it is recommended - if possible specific to the installation - to back up the return flow pressure in ports T to approx. 20% of the pressure differential at the component.
- Dependent on the hydraulic fluid used, the maximum ambient and hydraulic fluid temperature must not exceed 50 °C. In order to reduce the heat input into the component, a maximum duty cycle of 50% in continuous operation has to be set for on/off valves (measuring period 300 s). If this is not possible due to the function, an energy-reducing control of these components is recommended, e.g. via a PWM plug-in amplifier.

electric				
Voltage type			Direct voltage	Alternating voltage 50/60 Hz
Nominal voltages according to VDE 0580	V		see page 5 and 6	see page 7 and 8
Voltage tolerance (nominal voltage)	%	±10		
Nominal power according to VDE 0580	▶ Standard version	W	30	–
	▶ Version "SO407"		8	–
	▶ Version "= UR"		34	–
Holding power	VA		–	50
Switch-on power	VA		–	220
Duty cycle (ED)	%		100 (S1 according to VDE 0580)	
Switching time according to ISO 6403 ³⁾	▶ ON	ms	25 ... 45	10 ... 20
	▶ OFF	ms	10 ... 25	15 ... 40
Maximum switching frequency ⁴⁾	▶ Standard version	1/s	4.2	2
	▶ Version "SO407"	1/s	2	–

³⁾ Measured without flow.

The **switching times** were determined for a hydraulic fluid temperature of 40 °C [104 °F] and a viscosity of 46 cSt. Switching times change dependent on hydraulic fluid temperatures, operating time and application conditions.

⁴⁾ In order to prevent damage to the interference protection diode, the admissible switching frequency has to be limited to 1 Hz for valves with interference protection circuit ("K72L", "K73L", "DL1", "DAL1", "DK24L1", "DK35L").

Technical data

(For applications outside the stated values, please ask us!)

electric			Direct voltage	Alternating voltage 50/60 Hz
Voltage type				
Maximum surface temperature of the coil ⁵⁾	► Standard version	°C [°F]	120 [248]	120 [248]
	► Version "SO407"	°C [°F]	85 [185]	-
	► Version "= UR"	°C [°F]	120 [248]	-
Insulation class VDE 0580	► Standard			
	- Direct voltage		F	
	- AC voltage		H	
	► Version "= UR"			
	- Version "G12", "G24"		H	
	- Version "G110", "W120R"		F	
Protection class according to DIN EN 60529	see page 5 ... 8			
Protection class according to VDE 0580	see page 5 ... 8			
Electrical protection	Maximum admissible switch-off overvoltage see page 5 ... 8 Every solenoid must be protected individually, using a suitable fuse with tripping characteristics K (inductive loads).			
Protective grounding conductor and screening	The valve must be installed on a surface that is included in the equipotential bonding. Connector pin assignment (CE-compliant installation) see page 24 ... 26			
Conformity	CE according to Low-Voltage Directive 2014/35/EU checked according to EN 60204-1:2006-01 and DIN VDE 0580, classified as component			

⁵⁾ Due to the **temperatures occurring at the surfaces** of the solenoid coils, the standards ISO 13732-1 and ISO 4413 need to be adhered to!

The specified surface temperature in AC solenoids is valid for fault-free operation. In the error case (e.g. blocking of the control spool), the surface temperature may increase above 180 °C [356 °F]. Thus, the system must be checked for possible dangers considering the ignition temperature of the hydraulic fluid used.

As fuse protection, circuit breakers

(see table on page 5 ... 8) must be used, unless the creation of an ignitable atmosphere can be excluded in a different way. In this way, the surface temperature in an error case can be limited to a maximum of 220 °C [428 °F].

You have to use cables that have been approved of for a working temperature of more than 50 °C [122 °F] (individual connection) and/or 90 °C [194 °F] (central connection).

Notes:

- The solenoid coils must not be painted.
- Any simultaneous actuation of 2 solenoids of one valve must be ruled out
- **Fast switch-on**
For accelerated switching on the solenoid side, valves with individual connection and a nominal voltage of 12 V or 24 V can be controlled with two times the voltage for a maximum of 100 ms (pulse width modulation see data sheet 30362). In this connection, the maximum admissible switching frequency is reduced to 3 1/s.
- **Dampened switching**
With valves of version "A12", damping of the switch-on and switch-off process is possible (smoothly switching). In this way, switching shocks in the system are considerably reduced.

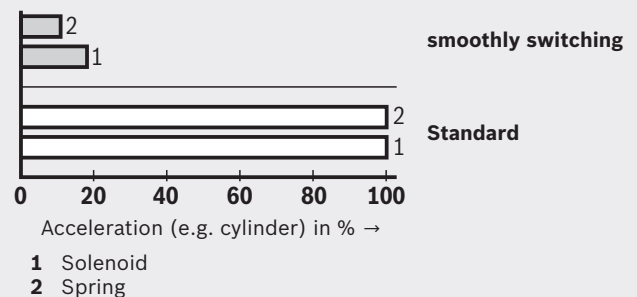

Electrical connections and available voltages see page 5 ... 8.

Characteristic curves

(measured with HLP46, $\vartheta_{oil} = 40 \pm 5 \text{ }^\circ\text{C} [104 \pm 9 \text{ }^\circ\text{F}]$)

Δp - q_v characteristic curves

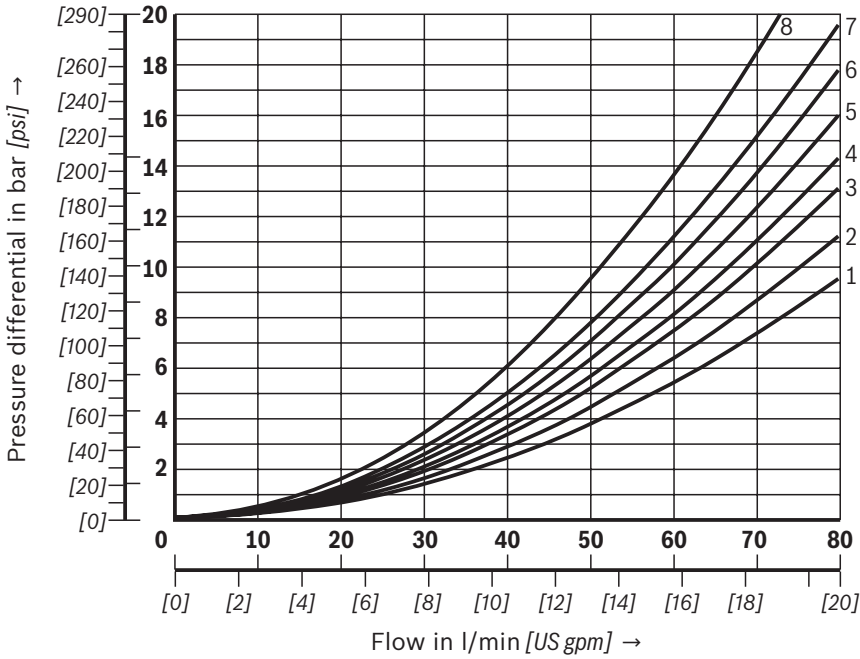

Symbol	Direction of flow			
	P - A	P - B	A - T	B - T
A; B	5	5	-	-
C; C46	3	3	5	3
D; D46; Y	6	6	5	5
E	5	5	3	3
F	3	5	3	3
T	8	8	4	4
H	2	1	2	2
J; Q	3	3	2	3
L	5	5	1	4
M	2	1	5	5
P	5	3	3	3
R	6	6	1	-
V	3	2	3	3
W	3	3	2	2
U	5	5	4	1
G	7	7	4	4

- 4 Symbol "H" in central position P - T
- 7 Symbol "R" in spool position B - A
- 8 Symbol "G" and "T" in central position P - T

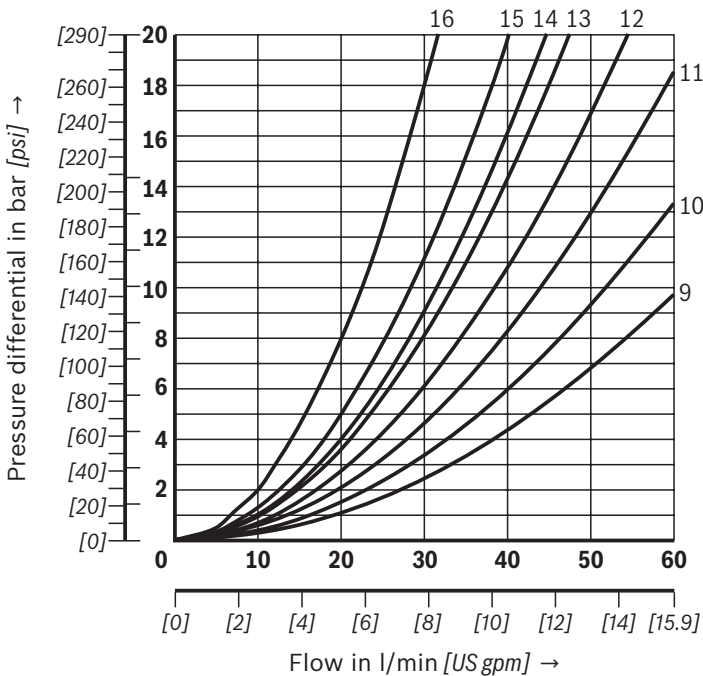

Symbol	Direction of flow					
	P - A	P - B	A - T	B - T	P - T	B - A
E73	11	11	11	11	-	-
J73	13	13	9	9	-	-
H73	11	11	11	11	12	-
A73; B73	15	15	-	-	-	-
D73; Y73	14	14	14	14	-	-
G73	16	16	16	16	12	-
R73	10	15	10	-	-	15
W73	10	10	10	10	-	-

Performance limits: DC voltage
 (measured with HLP46, $\vartheta_{oil} = 40 \pm 5 \text{ °C}$ [$104 \pm 9 \text{ °F}$])

Notice:

The specified performance limits are valid for operation with two directions of flow (e.g. from P to A and simultaneous return flow from B to T). Due to the flow forces acting within the valves, the achievable performance limit may be considerably lower

with only one direction of flow

(e.g. from P to A while port B is blocked)!

The performance limits were determined when the solenoids were at operating temperature, at 10% undervoltage and without tank preloading.

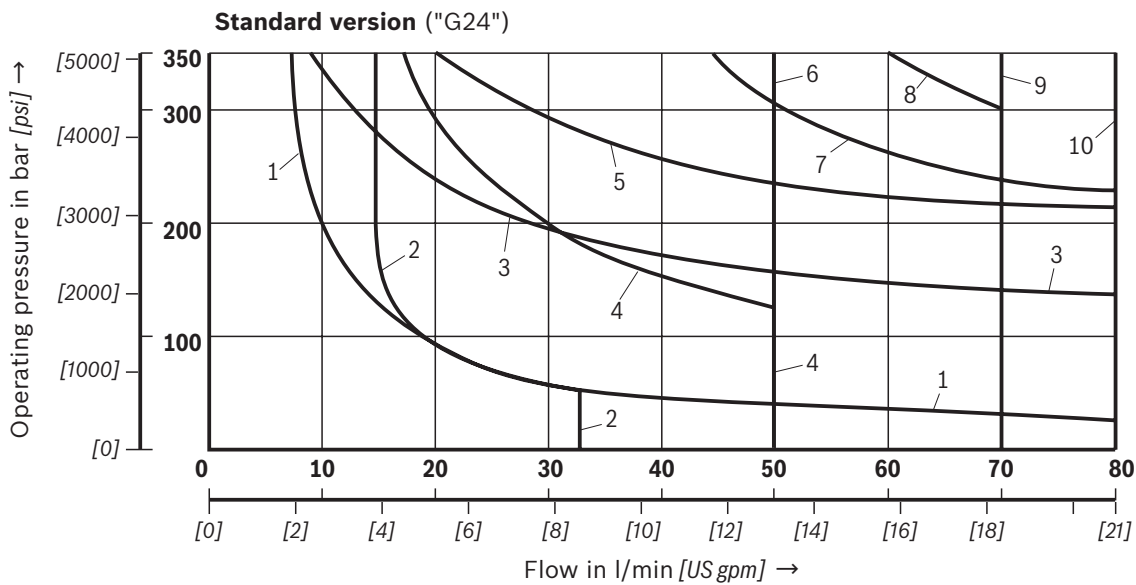

Characteristic curve	Symbol
1	A; B ¹⁾
2	V
3	A; B
4	F; P
5	J
6	G; H; T
7	A/O; A/OF; L; U
8	C; D; Y
9	M
10	E; E1- ²⁾ ; R ³⁾ ; C/O; C/OF; D/O; D/OF; Q; W

¹⁾ With manual override

²⁾ P – A/B pre-opening

³⁾ Return flow from actuator to tank

Performance limits: DC voltage
 (measured with HLP46, $\vartheta_{oil} = 40 \pm 5 \text{ }^\circ\text{C}$ [$104 \pm 9 \text{ }^\circ\text{F}$])

see notice on page 15.

Version "A12" ("G24")

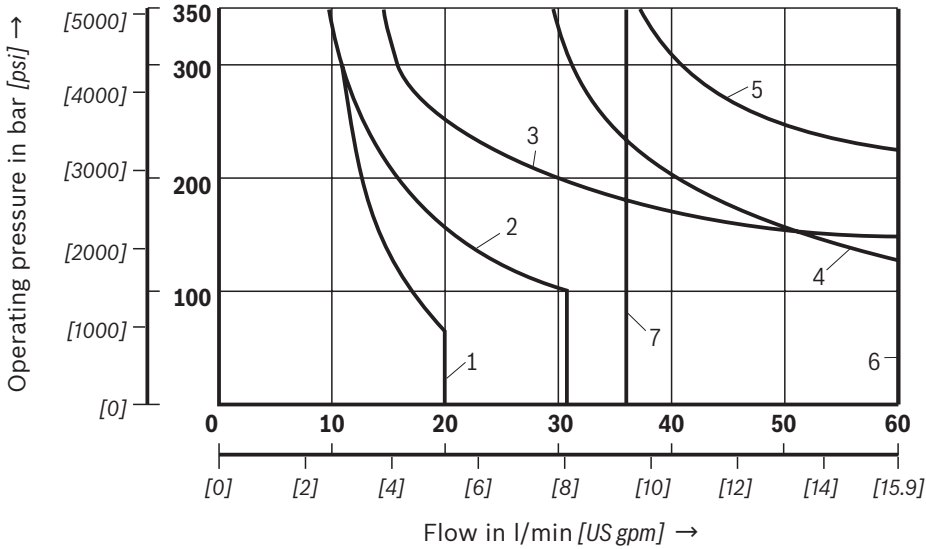

Characteristic curve	Symbol
1	A73, B73
2	G73
3	D73, Y73
4	J73
5	R73
6	E73, W73, D73/OF
7	H73

Version "SO407" ("G24")

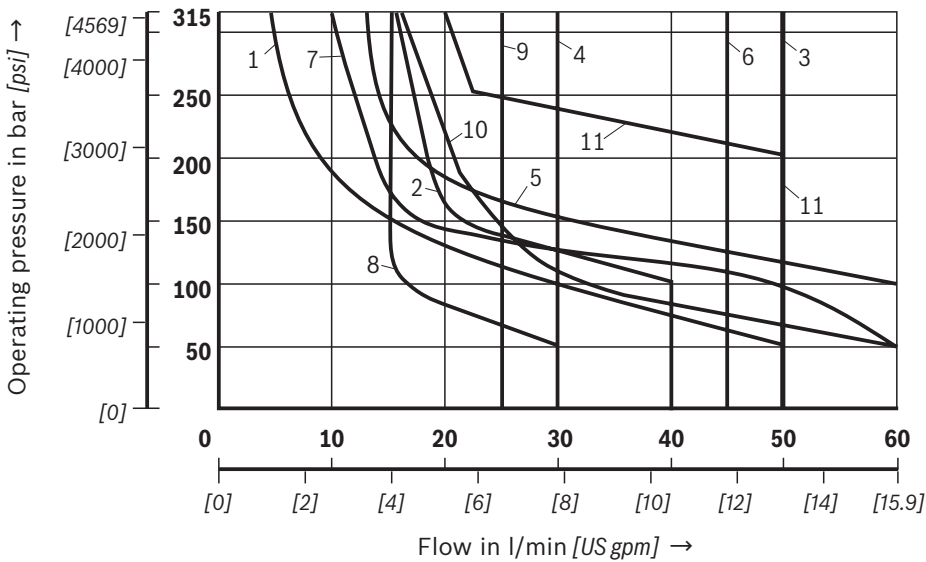

Characteristic curve	Symbol
1	A
2	C, D, Y
3	M
4	G
5	E
6	H
7	J
8	V
9	T
10	R ⁴⁾
11	C46/OF; D46/OF

⁴⁾ Return flow from actuator to tank

Performance limits: AC voltage
 (measured with HLP46, $\vartheta_{oil} = 40 \pm 5 \text{ °C}$ [$104 \pm 9 \text{ °F}$])

see notice on page 15.

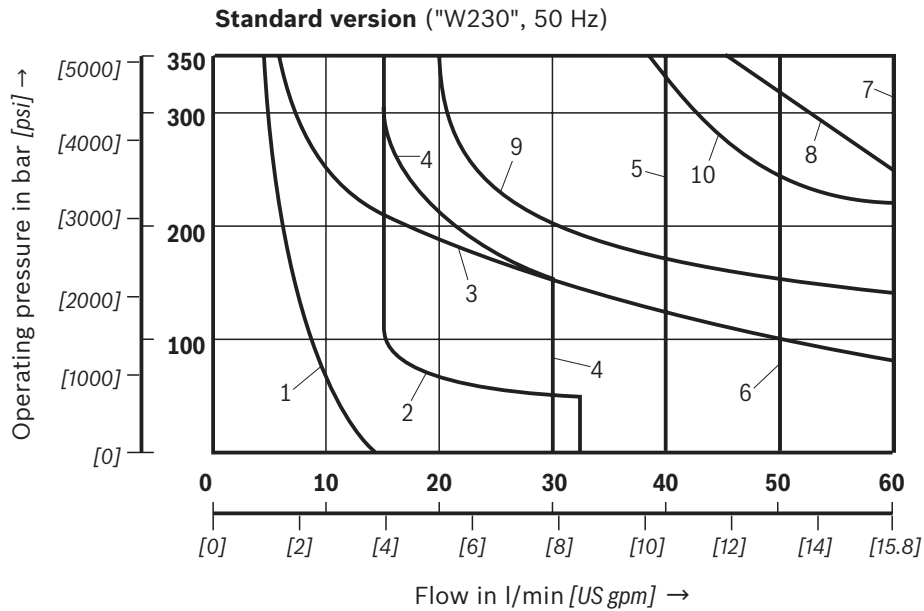

Characteristic curve	Symbol
1	A; B ¹⁾
2	V
3	A; B
4	F; P
5	G; T
6	H
7	C/O; C/OF; D/O; D/OF; E; E1 ⁻²⁾ ; J; M; R ³⁾
8	C; D; Y
9	J; L; U
10	A/O; A/OF; Q; W

Voltages see page 7 and 8.

- 1) With manual override
- 2) P – A/B pre-opening
- 3) Return flow from actuator to tank

Dimensions: Direct voltage – individual connection
(dimensions in mm [inch])

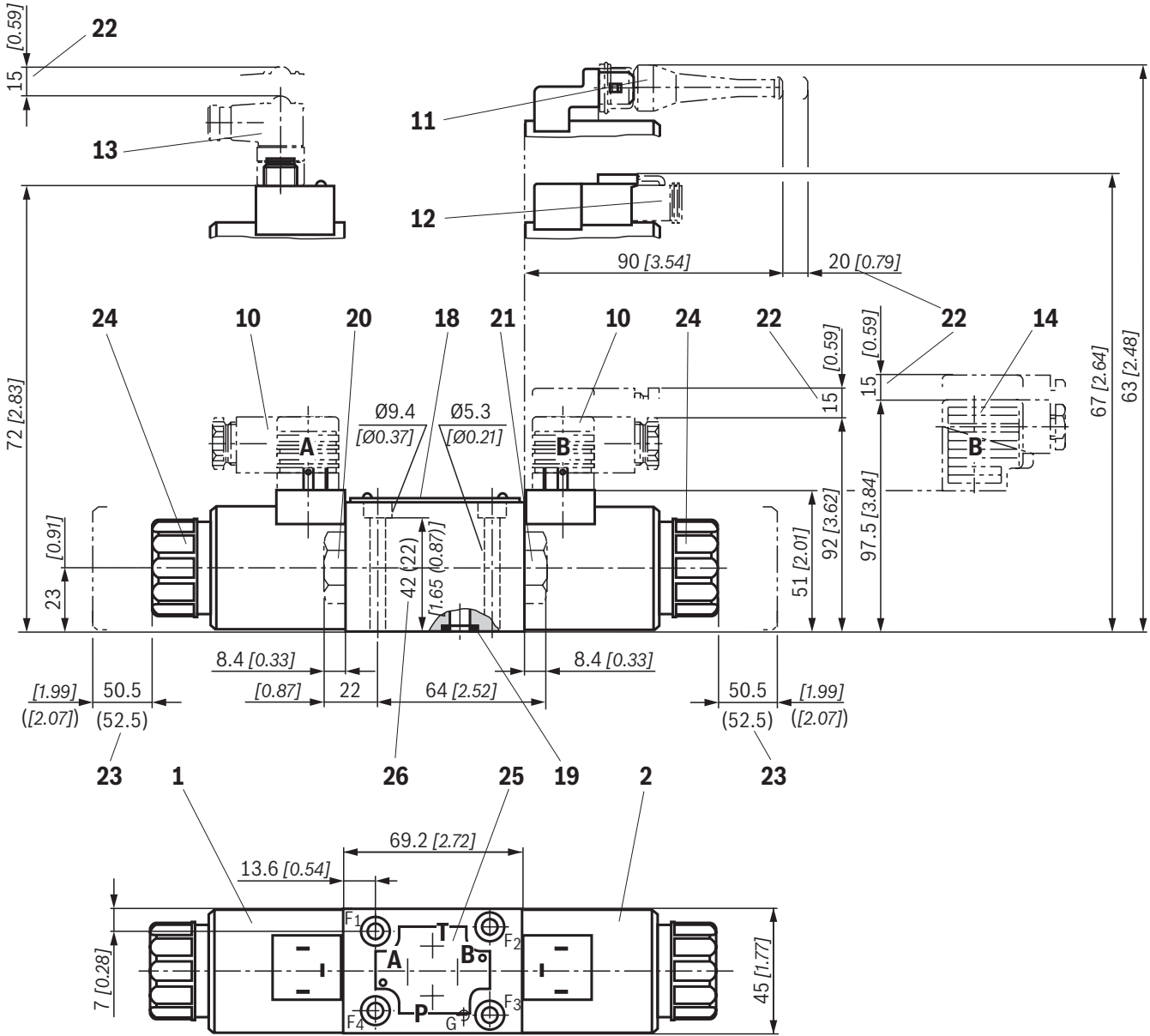

Dimensions for manual overrides see page 20.
For **item explanations**, **valve mounting screws** and **subplates** see page 23.

Notice:
The dimensions are nominal dimensions which are subject to tolerances.

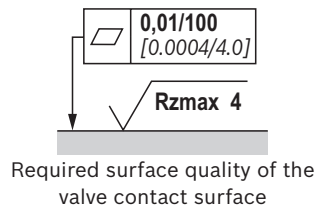

Dimensions: Direct voltage – central connection
(dimensions in mm [inch])

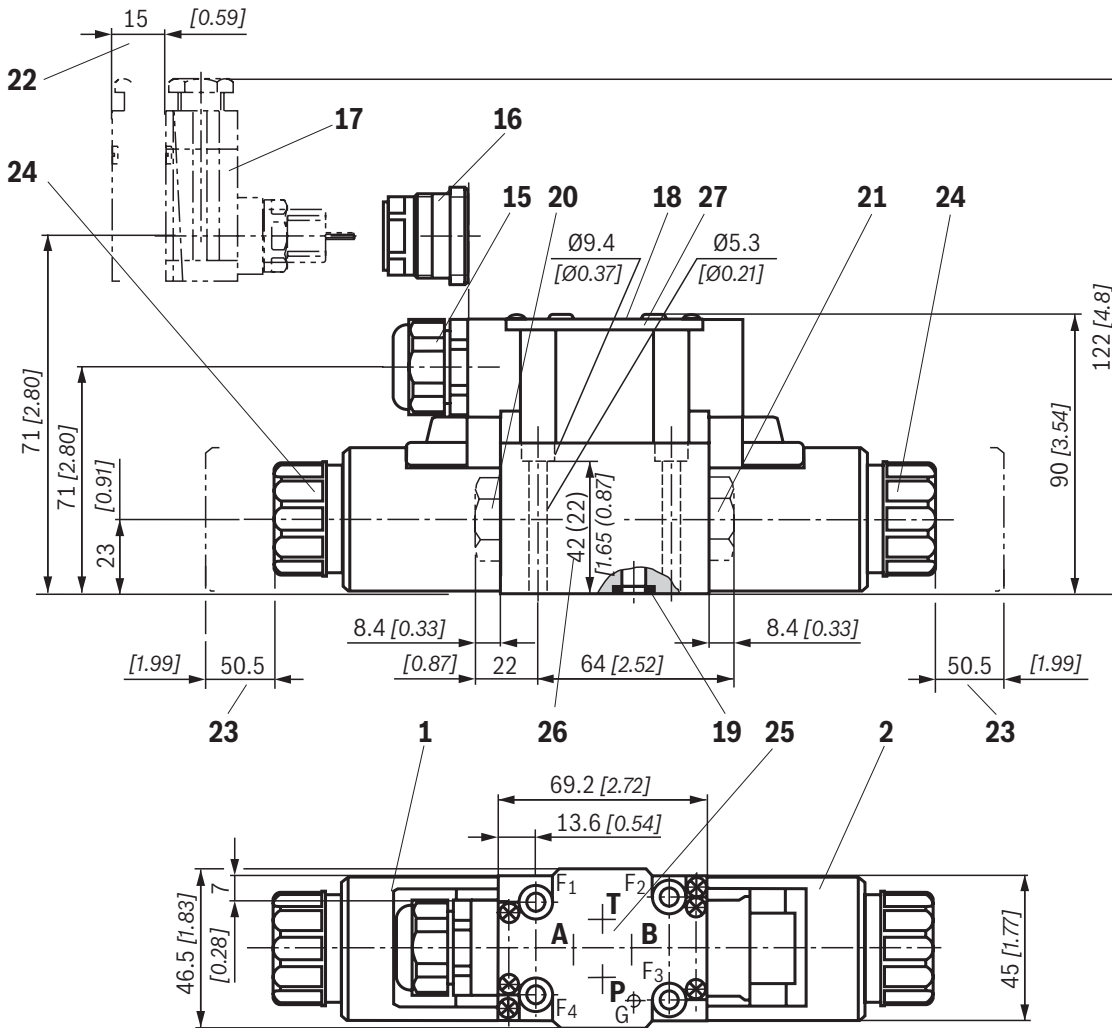

Dimensions for manual overrides see page 20.
For **item explanations**, **valve mounting screws** and **subplates** see page 23.

$\sqrt{0.01/100}$
[0.0004/4.0]

Rzmax 4

Required surface quality of the valve contact surface



Notice:

The dimensions are nominal dimensions which are subject to tolerances.

Dimensions: Direct voltage – manual overrides
(dimensions in mm [inch])

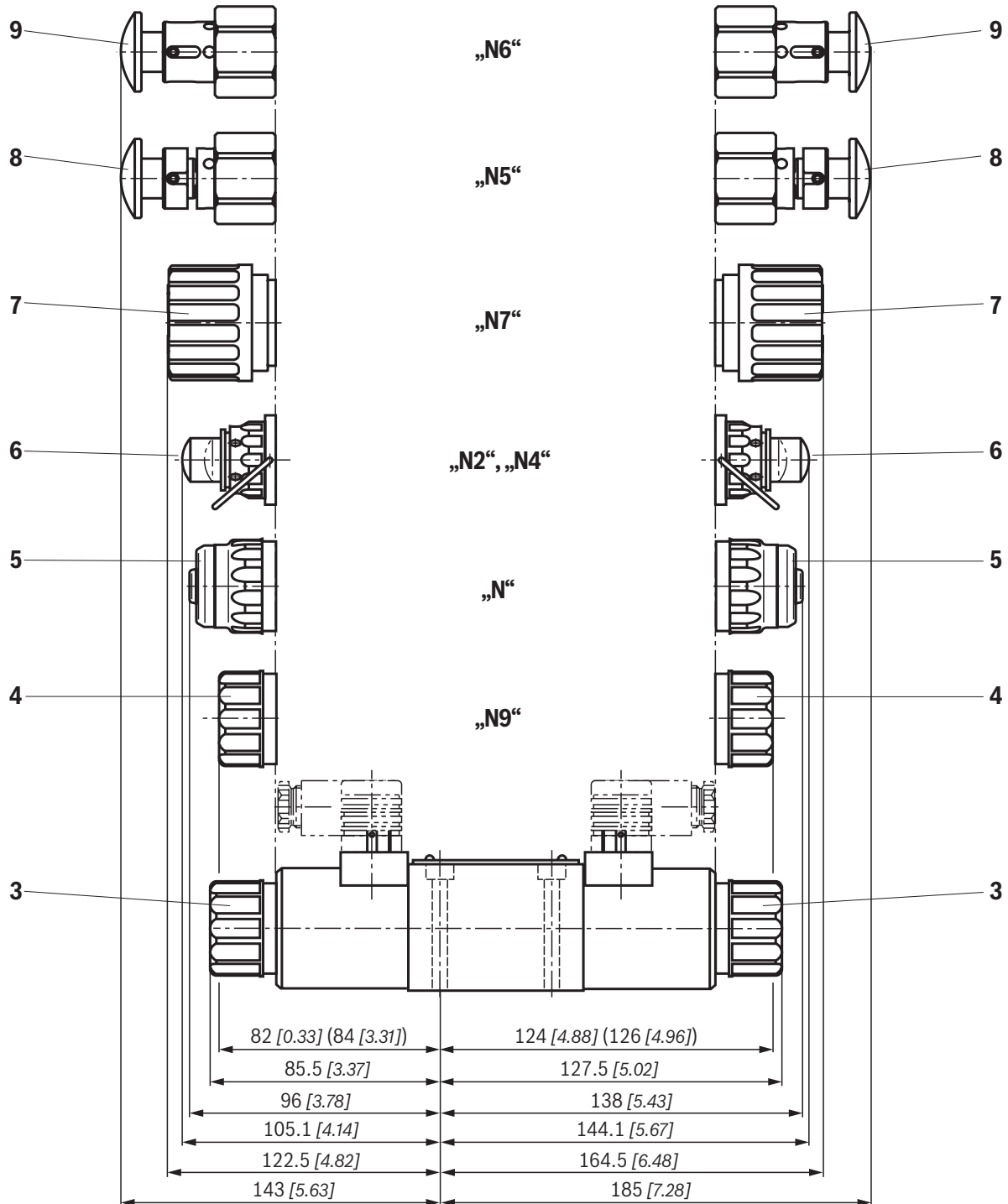

For item explanations, valve mounting screws and subplates see page 23.



Notice:

The dimensions are nominal dimensions which are subject to tolerances.

0,01/100
[0.0004/4.0]

Rzmax 4

Required surface quality of the valve contact surface

Dimensions: Alternating voltage – individual connection
(dimensions in mm [inch])

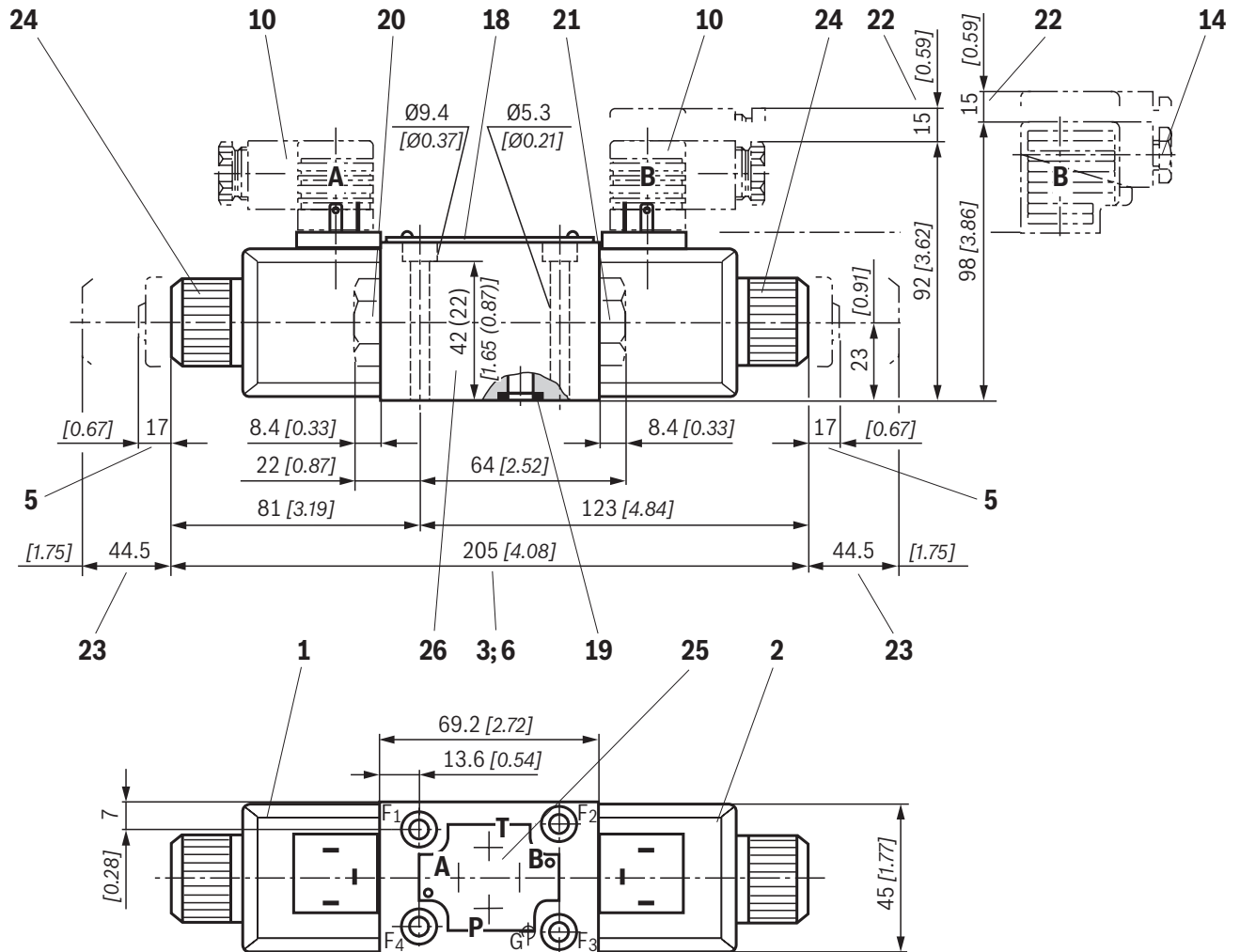

For item explanations, valve mounting screws and subplates see page 23.

Notice:

The dimensions are nominal dimensions which are subject to tolerances.

0,01/100
[0.0004/4.0]

Rzmax 4

Required surface quality of the valve contact surface

Dimensions: Alternating voltage – central connection
 (dimensions in mm [inch])

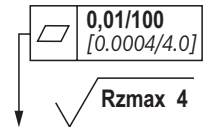
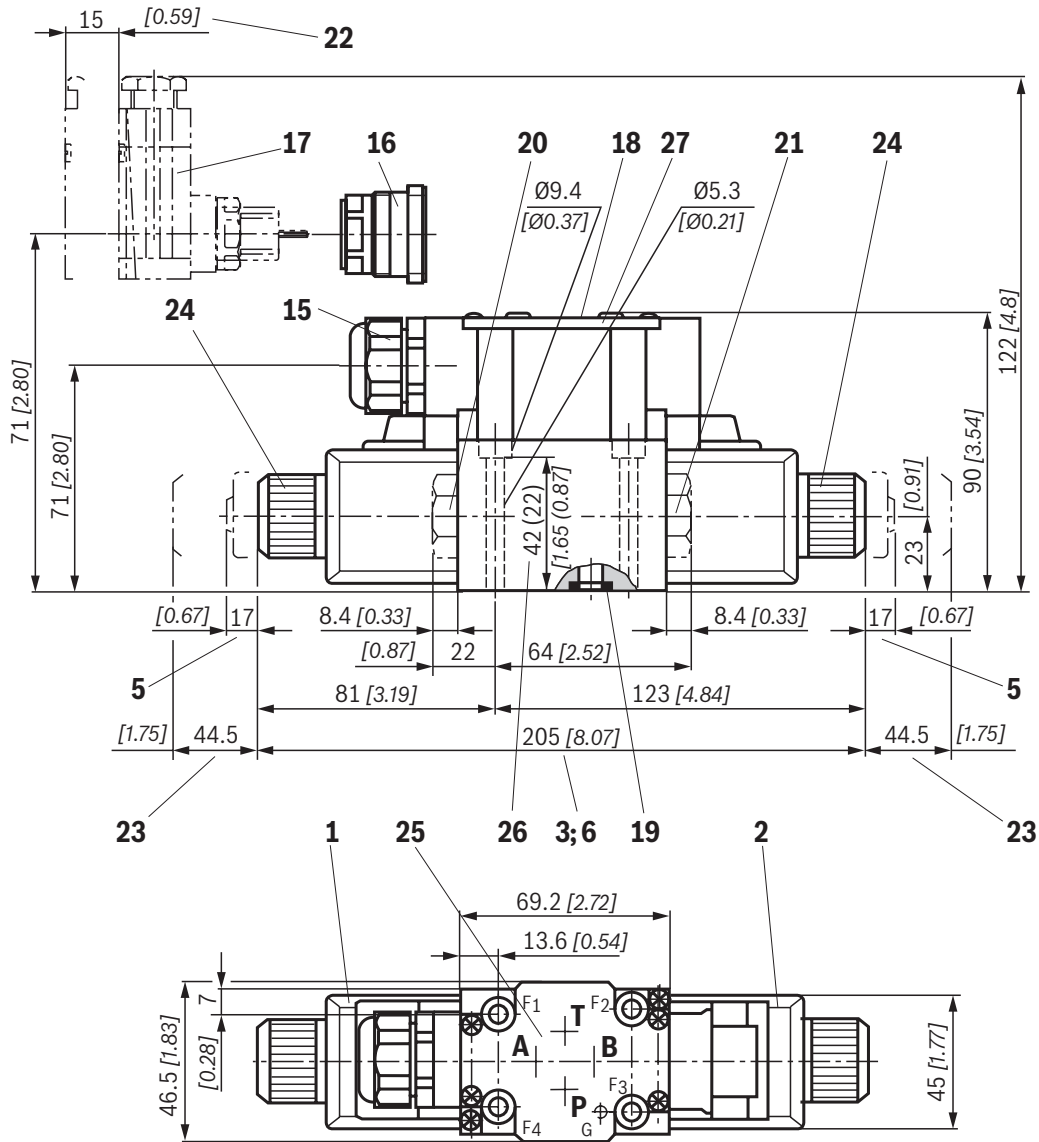

Required surface quality of the valve contact surface

Notice:
 The dimensions are nominal dimensions which are subject to tolerances.

For **item explanations, valve mounting screws and subplates** see page 23.

Dimensions



- 1 Solenoid "a"
- 2 Solenoid "b"
- 3 **Without** manual override
- 4 **Concealed** manual override "**N9**" (standard); dimensions () version "= UR"
- 5 Manual override "**N**"
- 6 Lockable manual override "mushroom button" (small) "**N4**"
- 7 Lockable manual override "nut" "**N7**"
- 8 Lockable manual override "mushroom button" (large) "**N5**"
- 9 Manual override "mushroom button" (large), not lockable "**N6**"
- 10 Mating connector **without** circuitry for connector "K4", tightening torque M3 maximum $M_{A \max} = 0.5 \text{ Nm}$ [0.37 ft-lbs] (separate order, see page 27 and data sheet 08006)
- 11 Mating connector (AMP Junior Timer) with connector "C4"(separate order, see page 27 and data sheet 08006)
- 12 Mating connector DT 04-2PA (Deutsch plug) with connector "K40" (separate order, see page 27 and data sheet 08006)
- 13 Mating connector angled with M12x1 plug-in connection with status LED "K72L" (separate order, see page 27 and data sheet 08006)
- 14 Mating connector **with** circuitry for connector "K4" (separate order, see page 27 and data sheet 08006)
- 15 Cable gland "DL"
- 16 Central plug-in connection "DK6L"
- 17 Mating connectors for valves with central connection with connector "DK6L" (separate order, see page 27 and data sheet 08006)
- 18 Name plate
- 19 Identical seal rings for ports A, B, P, T
 **Notice:** The ports are clearly determined according to their tasks and must not be arbitrarily interchanged or closed.
- 20 Plug screw for valves with one solenoid on B side
- 21 Plug screw for valves with one solenoid on A side
- 22 Space required to remove the mating connector/angled socket
- 23 Space required to remove the coil; dimensions () version "= UR"
- 24 Mounting nut, tightening torque $M_A = 4^{+1} \text{ Nm}$ [2.95^{+0.74} ft-lbs]
- 25 Porting pattern according to ISO 4401-03-02-0-05 (with or without locating hole) and NFPA T3.5.1 R2-2002 D03 (with locating hole for locking pin ISO 8752-3x8-St, material no. **R900005694**, separate order)
- 26 Alternative clamping length (): 22mm [0.87 inch]
- 27 Cover
Notice:
 The valve may only be operated with properly mounted cover.

Subplates (separate order) with porting pattern according to ISO 4401-03-02-0-05 and NFPA T3.5.1 R2-2002 D03 see data sheet 45100.

Valve mounting screws (separate order)

Clamping length	Quantity	Hexagon socket head cap screws	Material number
42 mm [1.65 inch]	4	ISO 4762 - M5 x 50 - 10.9-fIZn-240h-L Friction coefficient $\mu_{\text{total}} = 0.09 \dots 0.14$; tightening torque $M_A = 7 \text{ Nm}$ [5.2 ft-lbs] $\pm 10 \%$	R913043758
	or		
	4	ISO 4762 - M5 x 50 - 10.9 Friction coefficient $\mu_{\text{total}} = 0.12 \dots 0.17$; tightening torque $M_A = 8.1 \text{ Nm}$ [6 ft-lbs] $\pm 10 \%$	Not included in the Rexroth delivery range
or			
22 mm [0.87 inch]	4	UNC 10-24 UNC x 2" ASTM-A574 Friction coefficient $\mu_{\text{total}} = 0.19 \text{ to } 0.24$; tightening torque $M_A = 11 \text{ Nm}$ [8.2 ft-lbs] $\pm 15 \%$ Friction coefficient $\mu_{\text{total}} = 0.12 \text{ to } 0.17$; tightening torque $M_A = 8 \text{ Nm}$ [5.9 ft-lbs] $\pm 10 \%$	R978800693
	or		
	4	ISO 4762 - M5 x 30 - 10.9 Friction coefficient $\mu_{\text{total}} = 0.12 \dots 0.17$; tightening torque $M_A = 8.1 \text{ Nm}$ [6 ft-lbs] $\pm 10 \%$	Not included in the Rexroth delivery range
	or		
	4	UNC 10-24 UNC x 1 1/4" Friction coefficient $\mu_{\text{total}} = 0.19 \dots 0.24$; tightening torque $M_A = 11 \text{ Nm}$ [8.2 ft-lbs] $\pm 15 \%$ Friction coefficient $\mu_{\text{total}} = 0.12 \dots 0.17$; tightening torque $M_A = 8 \text{ Nm}$ [5.9 ft-lbs] $\pm 10 \%$	R978802879

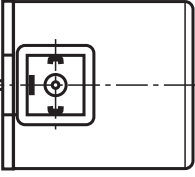
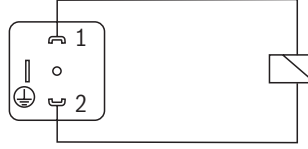
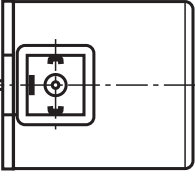
Electrical connections, assignment – individual connection

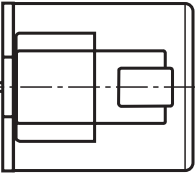
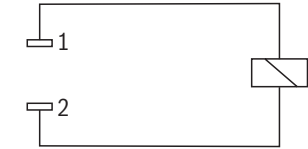
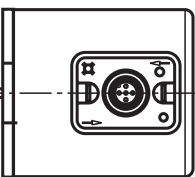
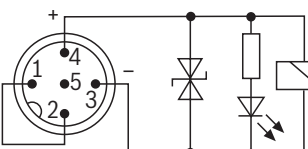
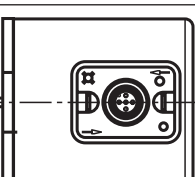
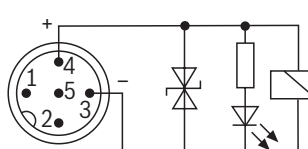
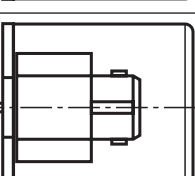
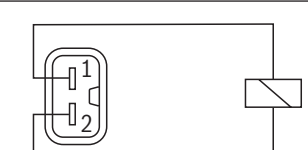
Ordering code connector	Top view	Circuit diagram	Pin	Connections, assignment	
Connector 3-pole (2 + PE) according to DIN EN 175301-803			1	Solenoid coil, polarity-independent	
			2		
Connector 3-pole (2 + PE) according to DIN EN 175301-803 (with potted-in plug base and sealing element)				Grounding	
Connector 2-pole, DT04-2PA (Deutsch type)			1	Solenoid coil, polarity-independent	
			2		
Connector, 4-pole, M12x1 according to DIN EN 61076-2-101 with suppressor diode, pin assignment according to DESINA			1	Internal bridge	
			2		
			3	Solenoid coil GND	
			4		Solenoid coil 24 V DC supply voltage
			5		
Connector, 4-pole, M12x1 according to DIN EN 61076-2-101 with suppressor diode			1	Without function	
			2		
			3	Solenoid coil GND	
			4		Solenoid coil 24 V DC supply voltage
			5		
Connector 2-pole, parallel to the valve axis (Junior-Timer type)			1	Solenoid coil, polarity-independent	
			2		

1) Coil with potted-in connector base and sealing element to valve housing (IP67)



2) Plug-in system suitable for mobile applications

When establishing the electrical connection, the protective grounding conductor (PE ) must be connected correctly.

Notes:

- ▶ Electric lines must be routed in a strain-relieved manner.
- ▶ Cable glands are only suitable for permanently installed cables.
- ▶ Connectors are to be locked during operation. Not intended to be plugged in or disconnected during normal operation under load.
- ▶ Use of finely stranded conductors with cross-section 0.75 mm² (AWG 20), 1 mm² (AWG 18), 1.5 mm² (AWG16) with suitable wire end ferrules without flange with a length of 8 mm [0.31 inch] based on DIN 46228-1.
- ▶ Crimping after stripping 9⁺¹ mm [0.35... 0.039 inch] by means of tool, e.g. "PZ 6/5", company Weidmüller.
- ▶ Proper connection of the protective grounding conductor at .
- ▶ Protective grounding conductor cross-section equal to or greater than the line cross-section of the voltage supply.
- ▶ The valve mounting surface must be connected to the protective grounding conductor system.

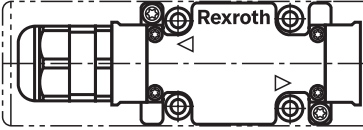
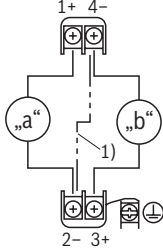
Electrical connections, assignment – central connection

Ordering code connector		Top view	Circuit diagram	Pin	Connections, assignment
Cable gland, terminal area 6 ... 12 mm [0.23... 0.47 inch], with indicator light, interference protection circuit optional	DL, DL1, DJL ¹⁾			1+	Valve solenoid "a"
				2-	
Cable gland, threaded connection 1/2"-14 NPT, with indicator light, interference protection circuit optional	DAL ²⁾ , DAL1 ²⁾			3+	Valve solenoid "b"
				4-	
					Grounding

1) Wire bridge with version "DJL"

2) Cable gland according to Conduit system with NPT thread; tightening torque $M_A = 5 \pm 0.5$ Nm

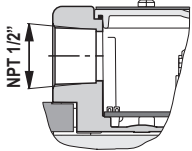

When establishing the electrical connection, the protective grounding conductor (PE ) must be connected correctly.

 See notes page 24.

Electrical connections, assignment – central connection

Ordering code connector	Top view	Circuit diagram	Pin	Connections, assignment
Connector 7-pole (6 + PE) according to DIN EN 175201-804, with indicator light			1	Valve solenoid "a"
			2	"a"
			3	Valve solenoid "b"
			4	"b"
			5	Not used
			6	Grounding
Connector 3-pole according to ANSI/B93.55M-1981 (Brad Harrison Mini-Change), with indicator light			2	Valve solenoid "a"
			3	Valve solenoid "b"
			Grounding	
Connector 5-pole according to ANSI/B93.55M-1981 (Brad Harrison Mini-Change), with indicator light			1	Valve solenoid "a"
			5	"a"
			2	Valve solenoid "b"
			4	"b"
3	Grounding			
Connector, 4-pole, M12x1 according to DIN EN 61076-2-101, with indicator light			1	Valve solenoid "a"
			3	"a"
			4	Valve solenoid "b"
			3	"b"
Connector, 4-pole, M12x1 according to DIN EN 61076-2-101, with indicator light and interference protection circuit			2	Valve solenoid "a"
			3	"a"
			4	Valve solenoid "b"
			3	"b"

When establishing the electrical connection, the protective grounding conductor (PE) must be connected correctly.

See notes page 24.

Accessories (separate order)

Mating connectors and cable sets

Item ¹⁾	Designation	Version	Short designation	Material number	Data sheet
10, 14	Mating connector; for valves with "K4" connector, 2-pole + PE, design A	Without circuitry, M16 x 1.5, 12 ... 240 V, "a"	Z4	R901017010	08006
		Without circuitry, M16 x 1.5, 12 ... 240 V, "b"		R901017011	
		Without circuitry, NPT 1/2", 12 ... 240 V, "a"	Z45	R900004823	
		Without circuitry, NPT 1/2", 12 ... 240 V, "b"		R900011039	
		With indicator light, M16 x 1.5, 12 ... 240 V	Z5L	R901017022	
		With indicator light, NPT 1/2", 12 ... 240 V	Z55L	R900057453	
		With rectifier, M16 x 1.5, 80 ... 240 V	RZ5	R901017025	
		With rectifier, NPT 1/2", 80 ... 240 V	RZ55	R900842566	
		With indicator light and Z-diode-suppressor, M16 x 1.5, 24 V	Z5L1	R901017026	
		With indicator light and rectifier, M16 x 1.5, 80 ... 240 V	RZ5L	R901017029	
With indicator light and rectifier, NPT 1/2", 80 ... 240 V	RZ55L	R900057455			
11	Mating connectors; for directional valves with "C4" connector (AMP Junior-Timer)	10 ... 32 V, 5 A	2P JUNIOR D2 2	R901022127	
		10 ... 32 V, 5 A	2P D1.2 JUNIOR	R900313533	
12	Mating connectors; for directional valves with "K40" connector (Deutsch plug)	10 ... 32 V, 5 A	2P DT06 K40AWG14	R900733451	
		10 ... 32 V, 5 A	2P DT06 K40AWG16	R901017847	
13	Mating connectors; for sensors and valves with "K24", "K35" and "K72" connectors, 4-pole	M12 x 1, angled, PG 7	4PZ24	R900779509	
		M12 x 1, angled, PG 7		R900082899	
17	Mating connectors; for valves with central connection with "DK6L" connector	250 V, 10 A, PG 11	7PZ6	R900002803	

¹⁾ See dimensions page 6 ... 23.

Energy savings and fast switching ¹⁾

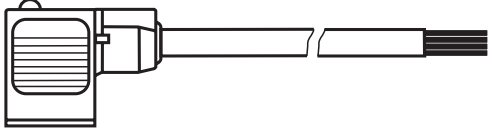
Details see data sheet 30362			
		Material number	
		Type VT-SSBA1-PWM-1X/V001/5 as fast switching amplifier (switching time reduction by approx. 50%) ²⁾	Type VT-SSBA1-PWM-1X/V002/5 for energy reduction (energy savings of approx. 40%) ³⁾
a/b	black	R901265633	R901290194

¹⁾ Only with symbols C, D, E, J, G, L and M

²⁾ Only for version "G12" and "K4"

³⁾ Only for version "G24" and "K4"

Cartridge with PWM connector according to data sheet 30362:

- ▶ Depending on the control spool, increasing the performance limit is possible.
- ▶ With version "G24" (energy saving), the coil temperature is reduced by ≥ 30 °C for 100% duty cycle.

Project planning information

Temperature range and maximum operating pressure in case of use at low temperatures

Port	Pressure	Temperature range in °C [°F]
- P, A, B, T	static 100 bar [1450 psi]	-40 ... -35 [-40 ... -31]
- P, A, B	dynamic from 100 bar [1450 psi] to 350 bar [5076 psi] in linear form as a function of the temperature	-35 ... -30 [-31 ... -22]
- T	dynamic from 100 bar [1450 psi] to 210 bar [3050 psi] in linear form as a function of the temperature	-35 ... -30 [-31 ... -22]
- P, A, B, T	Maximum operating pressure	-30 ... +50 [-22 ... 122]

Further information

- ▶ Subplates Data sheet 45100
- ▶ Inductive position switch and proximity sensors (contactless) Data sheet 24830
- ▶ Hydraulic fluids on mineral oil basis Data sheet 90220
- ▶ Environmentally compatible hydraulic fluids Data sheet 90221
- ▶ Flame-resistant, water-free hydraulic fluids Data sheet 90222
- ▶ Flame-resistant hydraulic fluids - containing water (HFAE, HFAS, HFB, HFC) Data sheet 90223
- ▶ Reliability characteristics according to EN ISO 13849 Data sheet 08012
- ▶ Connector switching amplifier with pulse width modulation (PWM) Data sheet 30362
- ▶ Hydraulic valves for industrial applications Data sheet 07600-B
- ▶ CE declaration of conformity according to Low-Voltage Directive 2014/35/EU upon request
- ▶ Selection of filters www.boschrexroth.com/filter
- ▶ Information on available spare parts www.boschrexroth.com/spc

Bosch Rexroth AG
 Industrial Hydraulics
 Zum Eisengießer 1
 97816 Lohr am Main, Germany
 Phone +49 (0) 93 52/ 40 30 20
my.support@boschrexroth.de
www.boschrexroth.de

© All rights reserved to Bosch Rexroth AG, also regarding any disposal, exploitation, reproduction, editing, distribution, as well as in the event of applications for industrial property rights.
 The data specified above only serve to describe the product. No statements concerning a certain condition or suitability for a certain application can be derived from our information. The information given does not release the user from the obligation of own judgment and verification.
 It must be remembered that our products are subject to a natural process of wear and aging.