



Nexvoo DoubleView Pro All-In-One Video Bar



User Manual (Model: N120W)

Packing List



DoubleView Pro N120W



Remote control



12V/2A
Power Adapter

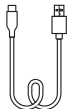

5m USB-C to
USB-A Cable

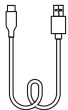

1.5m USB-C to
USB-A Cable



1.8m HDMI Cable

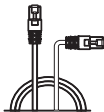

1.5m Ethernet Cable

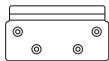

Mounting Bracket
and Accessories



Warranty Card



User Manual

1. DoubleView Pro N120W
2. Remote Control
3. 12/2A Power Adapter
4. 5m USB-C to USB-A Cable
5. 1.5m USB-C to USB-A Cable
6. 1.8m HDMI Cable
7. 1.5m Ethernet Cable
8. Mounting Bracket and Accessories
9. Warranty Card
10. User Manual

Note: We recommend that you use the accessories provided or approved by Nexvoo, using uncertified accessories may cause uncertain problems.

Product Introduction

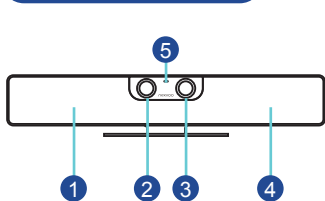

- 1 Mic Arrays
- 2 Telephoto Camera
- 3 4K Ultra-Wide Camera
- 4 Speaker
- 5 Camera LED
- 6 Power Connector(12V/2A)
- 7 3.5mm Audio Output

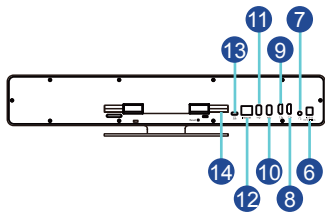

- 8 HDMI Output 2
- 9 HDMI Output 1
- 10 USB-A Input 2
- 11 USB-A Input 1
- 12 RJ45 Ethernet Port
- 13 USB-C Output
- 14 Reset Port

Camera Indicator

LED Color	LED Status	Function Description
●	Always on	Camera is off.
	Blink slowly	The microphone is muted.
	Blink quickly	The device is being restored to factory Settings. The device is updating the firmware.
●	Always on	Camera is on.

Remote Control

1. The remote control shall be equipped with two AAA batteries.
2. You can press and hold "VOL-" and "ZOOM-" for 3 seconds at the same time, while the indicator light flashes. DoubleView Pro N120W will be connected to the remote control automatically. Once connected, the indicator light of the remote control will be off and the display interface will prompt "Remote Control Connected".

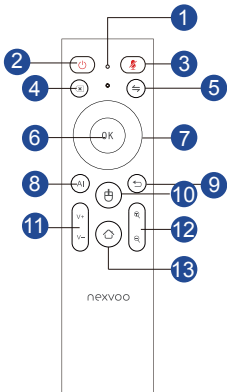

NO.	Button Name	Function Description
1	Indicator	Press any button, the indicator light is on.
		Open the mouse function, the indicator light remains on.
		When the remote control is in pairing mode, the indicator light flashes quickly.
2	Sleep	Press the button to close the screen display, press the button again to open the screen display.
3	Mute	Press the button to turn off the microphone, press the button again to turn on the microphone.
4	Delete	Press the button to delete the text in the input box.
5	Switch control	Press the button to switch the remote control to control Video mode or USB mode.
6	OK	Press the button to confirm the selection or open the APP in Video mode.
		Press the button to switch wide angle lens or telephoto lens in USB mode.
7	Direction	Press the up, down, left or right direction button to move the cursor in Video mode.
		Press the direction button to pan and tilt camera when the AI function is turned off in USB mode.
8	AI	Press the button to open or close the AI function (Auto frame and Speaker Tracking).
9	Return	Press the button, return to the previous interface or exit App.
10	Mouse	Press the button to open the mouse function (Default is closed), the red indicator of the remote control remains on.
11	VOL +/-	Increase/decrease speaker volume.
12	ZOOM +/-	Press ZOOM + / - button to zoom in/out when the AI function is turned off.
13	Home	Press the button to return to home interface.
14	VOL- and ZOOM -	Press and hold "VOL-" and "ZOOM-" for 3 seconds at the same time, while the indicator light flashes, the remote control is in pairing mode.

Installation Instructions

Put on a flat surface

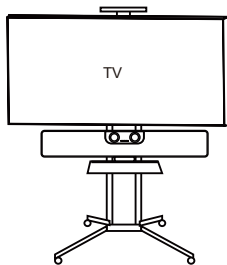
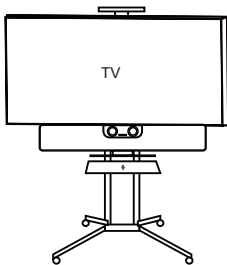
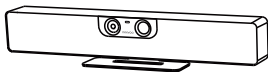

Mount on a wall

Placing DoubleView Pro N120W

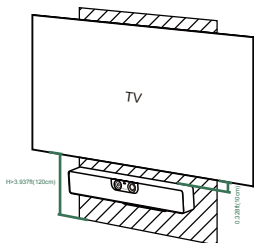

Mount the DoubleView Pro N120W below the TV when the mounting height of the lower side of the TV is higher than 3.937ft(120cm).

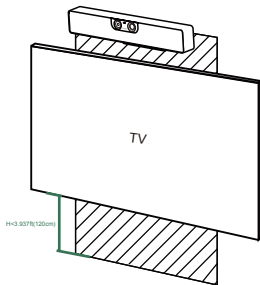

Mount the DoubleView Pro N120W above the TV when the mounting height of the upper side of the TV is lower than 3.937ft(120cm).

Wall Mounting

Use the bracket to mount your endpoint on a wall. The mounting height affects your camera view. The recommended height is 1.1m above the ground.

Step1: Assemble the mounting bracket

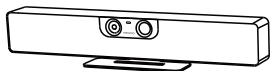

Step2: Mount the DoubleView Pro N120W on the wall

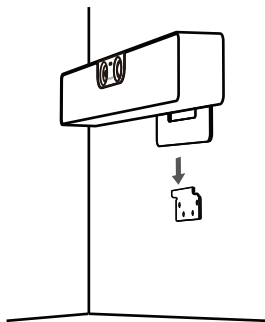
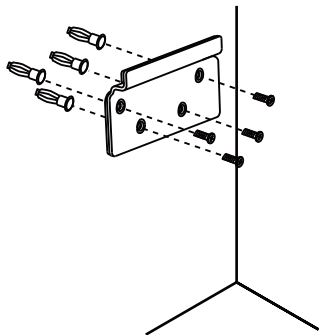

Adjusting The Camera Tilt

Adjust the device angle after switching to the telephoto camera.

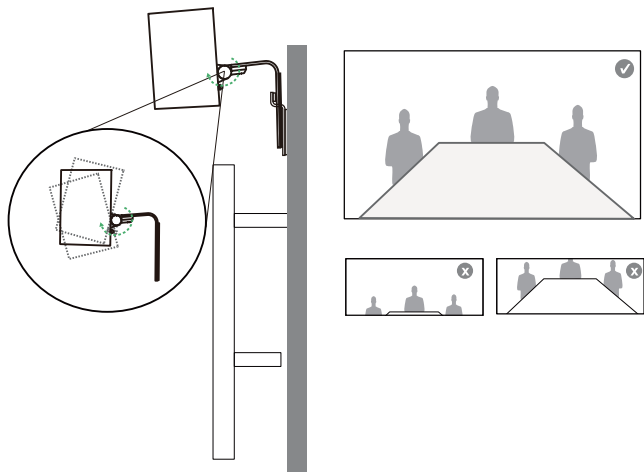

Powering On and Off

DoubleView Pro N120W doesn't have a power button. When you plug in the power cord, the device turns on.

Connection and Usage

1. Connecting to the displayer

- Connecting DoubleView Pro and displayer through HDMI 1 Output port.
- Connecting DoubleView Pro to power adapter, the device turns on.
- Network can be connected through Ethernet cable or WIFI.
- Open video conference platform (for example Microsoft Teams, Zoom, ...), successfully connected to the meeting achieved and turned on the camera when green light remains on.
- Short press Sleep button of remote control to turn off screen display when meeting is over.
- Disconnect the power and turn off DoubleView Pro, if necessary.

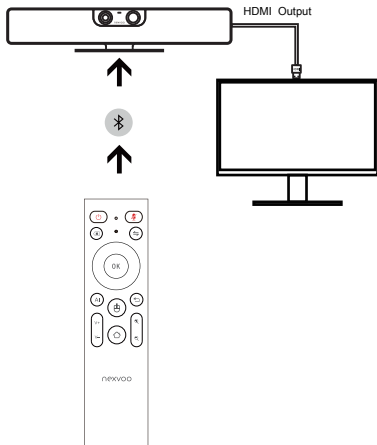

Notes: The default display connected to HDMI1 or HDMI2 output port is the same, whether different displays can be output depends on the video conferencing platform used.

Join the meeting quickly through DoubleView Pro's Web Server:

- Connect DoubleView Pro and your computer to the same LAN network.
- Start the browser on your computer, enter the IP address of DoubleView Pro and open the Web Server (such as <http://192.168.1.100>).
- Enter the meeting link on the Web Server page and click "**Send**" (for example, enter the Zoom meeting link).
- After DoubleView Pro receives the Zoom meeting link, it automatically opens the meeting link through the browser, selects and clicks "Launch App" via the remote control on the browser page, DoubleView Pro launches the Zoom App and automatically joins the Zoom meeting.

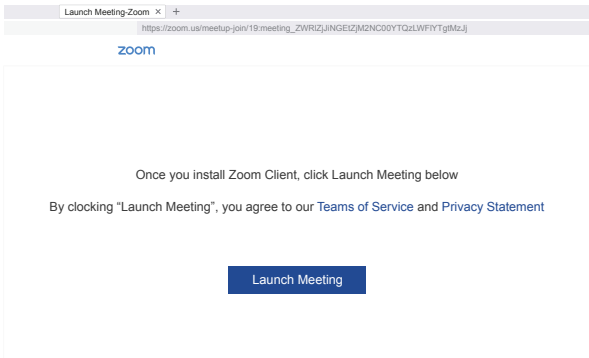
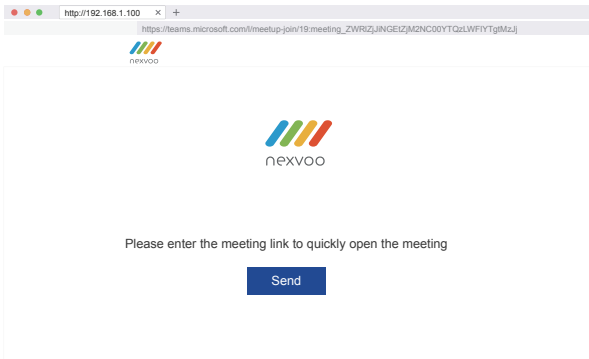

2. Connecting to computer

- Connecting DoubleView Pro to power adapter, the device turns on.
- Connecting DoubleView Pro to computer through USB-C Output port
- Open video conference platform on your computer (for example Microsoft Teams, Zoom, ...), successfully connected to the meeting achieved and turned on the camera when green light remains on.
- Disconnect the Doubleview Pro from the computer after the meeting.

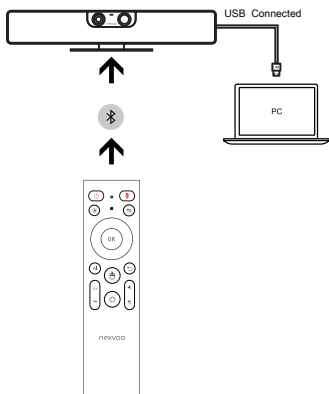

Notes: During usage by connecting to the computer, there is no output from HDMI.

3. System Update

- Connecting DoubleView Pro and displayer through HDMI port to ensure network connected. System will pop up update notification, click "Update" button to update.

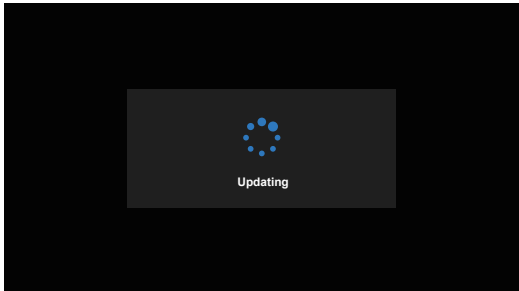
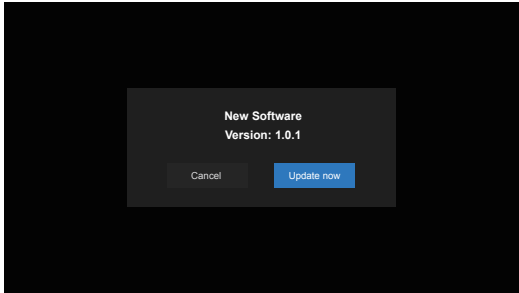

1. Operating Ambient Temperatures

Operating temperature: +32 to 104°F (0 to 40°C)

Storage temperature: -13 to +160°F (-25 to +70°C)

Relative humidity: 5% to 90%, non-condensing

2. Warranty

Our product warranty is limited only to the unit itself, when used normally in accordance with the operating instructions and the system environment. We are not liable for damage or loss resulting from the use of this product, or for any claim from a third party. We are not liable for problems with Nexvoo device arising from the use of this product; we are not liable for financial damages, lost profits, claims from third parties, etc., arising from the use of this product.

3. Explanation Of The Symbols DC



·Symbol is the DC voltage symbol.



·WEEE Warning symbol

To avoid the potential effects on the environment and human health as a result of the presence of hazardous substances in electrical and electronic equipment, end users of electrical and electronic equipment should understand the meaning of the crossed-out wheeled bin symbol.

Do not dispose of WEEE as unsorted municipal waste and have to collect such WEEE separately.

4. Restriction Of Hazardous Substances Directive (ROHS)

This device complies with the requirements of the EU ROHS Directive.

Statements of compliance can be obtained by contacting support@nexvoo.com.

5. Safety Instructions

Save these instructions. Read these safety instructions before use!



General Requirements

Before you install and use the device, read the safety instructions carefully and observe the situation during operation.

During the process of storage, transportation, and operation, please always keep the device dry and clean, avoid collision and crash.

Please attempt not to dismantle the device by yourself. In case of any discrepancy, please contact the appointed maintenance center to repair.

Please refer to the relevant laws and statutes while using the device. Legal rights of others should be respected as well.

Environmental Requirements

Place the device at a well-ventilated place. Do not expose the device under direct sunlight.

Keep the device dry and free of dusts.

Do not place the device on or near any inflammable or fire-vulnerable object, such as rubber-made materials.

Keep the device away from any heat source or bare fire, such as a candle or an electric heater.

Operating Requirements

- Do not let a child operate the device without guidance.
- Do not let a child play with the device or any accessory to avoid accidental swallowing.
- Please use the accessories provided or authorized by the manufacturer only.
- Please use the provided surge protection power socket only.
- Before plugging or unplugging any cable, make sure that your hands are completely dry.
- Do not spill liquid of any kind on the product or use the equipment near water, for example, near a bathtub, washbowl, kitchen sink, wet, and basement or near a swimming pool.
- During a thunderstorm, stop using the device and disconnect the power supply and USB connection line to avoid lightning strike.
- If the device is left unused for a rather long time, disconnect it from the power supply and unplug the power plug.
- When there is smoke emitted from the device, or some abnormal noise or smell, disconnect the device from the power supply, and unplug the power plug immediately.
- Contact the specified maintenance center for repair.
- Do not insert any object into equipment slots that is not part of the product or auxiliary product.
- Before connecting a cable, connect the grounding cable of the device first.
- Do not disconnect the grounding cable until you disconnect all other cables.

Cleaning Requirements

- Before cleaning the device, disconnect it from the power supply.
- Use a piece of soft, dry and anti-static cloth to clean the device.
- Keep the power plug clean and dry.

6. Troubleshooting

Q: The unit cannot supply power to Nexvoo device.

A1: There is a bad connection with the plug.

- (1) Clean the plug with a dry cloth.
- (2) Connect it to another wall outlet.

A2: The usage environment is out of operating temperature range.

(1) Use in the operating temperature range.

A3: The cable between the unit and the Nexvoo device is connected incorrectly

(1) Connect the cable correctly.

A4: You cannot connect the cable properly.

(1) You may have connected a wrong Nexvoo device.

(2) Use the correct power supply.

A5: Some dust, etc., may be in the port

(1) Clean the port

Contact your dealer or authorized service facility for any further questions.

7. FCC Caution

This device complies with part 15 of the FCC Rules. Operation is subject to the following two conditions:

(1) This device may not cause harmful interference, and

(2) this device must accept any interference received, including interference that may cause undesired operation.

Any Changes or modifications not expressly approved by the party responsible for compliance could void the user's authority to operate the equipment.

Note: This equipment has been tested and found to comply with the limits for a Class B digital device, pursuant to part 15 of the FCC Rules. These limits are designed to provide reasonable protection against harmful interference in a residential installation. This equipment generates uses and can radiate radio frequency energy and, if not installed and used in accordance with the instructions, may cause harmful interference to radio communications. However, there is no guarantee that interference will not occur in a particular installation. If this equipment does cause harmful interference to radio or television reception, which can be determined by turning the equipment off and on, the user is encouraged to try to correct the interference by one or more of the following measures:

-Reorient or relocate the receiving antenna.

-Increase the separation between the equipment and receiver.

-Connect the equipment into an outlet on a circuit different from that to which the receiver is connected.

-Consult the dealer or an experienced radio/TV technician for help.

8. RF warning for Portable device

The device has been evaluated to meet general RF exposure requirement. The device can be used in portable exposure condition without restriction.

9. Copyright

Except where expressly stated otherwise, no use should be made of the Documentation, Software, Hosted Service, or hardware provided by Nexvoo.

All content the documentation, Hosted Service, and the product provided by Nexvoo including the selection, arrangement and design of the content is owned either by Nexvoo or its licensors and is protected by copyright, and other intellectual property laws including the sui generis rights relating to the protection of databases. You may not modify, copy, reproduce, republish, upload, post, transmit or distribute in any way any content, in whole or in part, including any code and software unless expressly authorized by Nexvoo.

Unauthorized reproduction, transmission, dissemination, storage, and or use without the express written consent of Nexvoo can be a criminal, as well as a civil offense.

10. Third Party Components

“Third Party Components” means certain software programs or portions thereof included in the Software or Hosted Service may contain software (including open source software) distributed under third party agreements (“Third Party Components”), which contain terms regarding the rights to use certain portions of the Software (“Third Party Terms”). As required, information regarding distributed Android source code (for those products that have distributed Android source code) and identifying the copyright holders of the Third Party Components and the Third Party Terms that apply are available in the products, Documentation or such successor site as designated by Nexvoo. The open source software license terms provided as Third Party Terms are consistent with the license rights granted in these Software License Terms, and may contain additional rights benefiting you, such as modification and distribution of the open source software. The Third Party Terms shall take precedence over these Software License Terms, solely with respect to the applicable Third Party Components to the extent that these Software License Terms impose greater restrictions on you than the applicable Third Party Terms.

Any Changes or modifications not expressly approved by the party responsible for compliance could void the user's authority to operate the equipment.

Product Information

Package Includes

- DoubleView Pro N120W
- Cable package
- Remote Control
- Wall mount
- User manual

Video Standards and Protocols

- H.264, H.265, MJPEG, YUV

Video Output

- 2 x HDMI
- Compatible with touch screen
- 1080p@60fps video output

Dual Camera System

- Ultra wide-angle camera
 - 8M pixels
 - f/1.8 aperture
 - 5x digital zoom / EPTZ
 - 120° FOV
 - Ultra HD 2160p (4K) capture resolution
- Telephoto camera
 - 2M pixels
 - f/2.0 aperture
 - 3x digital zoom
 - 58° FOV
- AI smart framing
 - Auto Framing
 - Speaker Tracking
 - Face Recognition
- Camera indicator

Audio

- Audio processing technology
 - Background noise elimination technology
 - Beamforming directional pickup technology
 - Multi-channel echo cancellation processing technology
 - Multi-channel de-reverberation technology
 - Long-distance full-duplex pickup technology
 - Automatic gain control
- Mute/unmute control
- Audio codec: G.711, G.729AB, G.729A, G.722.2 (AMR-WB)

Audio Input

- 8 MEMS microphone arrays
- 8 m / 26 feet high-quality pickup distance

Audio Output

- Speakers, 100dB@1m
- 1 x 3.5mm line-out

Operating System

- Video Mode
 - Android 9.0
 - Multimedia desktop design
 - Support video conferencing systems, including: Zoom, Microsoft Teams, etc.
- USB Mode
 - Provide USB camera for PC, up to 4K@30fps
 - Provide USB Audio for PC

Other Physical Properties

- Power adapter: AC100~240V input, DC12V/2A
- RAM/ROM: 4G / 32G
- USB output: DC 5V/500mA
- Dimensions (H.W.D):
 - 78 x 503 x 53 (MM)
 - 3.07 x 19.8 x 2.09 (Inches)
- Weight: 1.8 kg / 3.97 lbs
- Operating environment humidity: 15~80%, non-condensing
- Operating environment temperature: 0~40°C
- Storage temperature: -30~70°C

Network and Security

- IPv4/IPv6
- Automatic MDIX
- Dynamic bandwidth allocation
- Simple Certificate Enrollment Protocol (SCEP)
- Active Directory external authentication

Other Interfaces

- 2 x USB-A (2.0)
- 1 x USB-C
- 1 x Ethernet port
- Bluetooth 4.2
- WIFI 802.11b/g/n/ac
- 1 x DC Power
- 1 x Reset key
- Kensington security lock

Warranty Information

- 2-year limited hardware

The specifications above are subject to changes without notice.



FC CE RoHS

Nexvoo, Inc.

Asia office:

No.56-58, North 5F, Huoju Plaza, Huoju Road, Huli district
Xiamen city, Fujian province
China

support@nexvoo.com

USA office:

9325 Uptown Drive, Suite 900
IN 46256 Indianapolis
USA

support@nexvoo.com

EMEA office:

Poort van Midden Gelderland Rood 22
6666 LT Heteren
The Netherlands

info@nexvoo.eu