

Ambientec

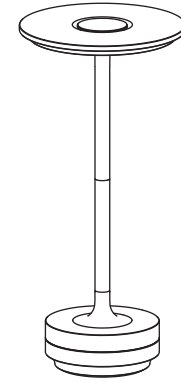

TURN
Design: Nao Tamura

TURN Stainless Steel TN001-01SS	TURN Brass TN001-01BS	TURN Aluminum Black TN001-01AB
---------------------------------------	-----------------------------	--------------------------------------

Instructions

Thank you for purchasing the Ambientec TURN.
Please read these instructions thoroughly before using the product.

Contents

- 1 Safety Precautions
- 2 Package Contents and Nomenclature
- 3 Before Using the Product
- 4 USB AC Adapter
- 5 Operation
- 6 Dustproof and Waterproof Specifications
- 7 Care and Maintenance
- 8 Disposing of This Product
- 9 Product Specifications

1 Safety Precautions

- To use the product correctly and safely, be sure to read the Safety Precautions before use. The Safety Precautions include critical information for safety. Be sure to heed them.
- The following symbols indicate the degree of risk or damage that may result if the information given after each symbol is ignored and the product is used improperly.

	DANGER Indicates an imminently hazardous situation which, if not avoided, will result in death or serious injury.
	WARNING Indicates a potentially hazardous situation which, if not avoided, could result in death or serious injury.
	CAUTION Indicates a potentially hazardous situation which, if not avoided, may result in minor/moderate injury or equipment damage.

If the product is used improperly and any of the following DANGER, WARNING, or CAUTION information is ignored, there is potential for fire, heat generation, damage, or leakage that may cause burns, injury, or loss of sight.

	Indicates "prohibited" actions that must not be performed.
	Indicates "compulsory" actions that must be performed.

DANGER

- Do not put the product in a fire or heat it in an oven.
- Do not expose the product to high temperatures or leave it in a place where it is subject to direct sunlight.
- Do not place the product within reach of infants and children.
- Do not open or modify the product.
- Do not apply an impact to the product by dropping it, throwing it, etc.
- Do not look directly at the LED light source when it is illuminated.
- Never open the base except when you are going to dispose of the rechargeable lithium-ion battery.
- Disconnect the product immediately if you notice smoke or smell something burning.

WARNING

- Do not short-circuit the recharging terminal of the main body or charger stand with a metal pin or other metallic object.
- Do not cover the product with cloth, paper, or any other easily flammable material.
- Keep water and other liquids away from the AC adapter and charger stand and do not use them while they are wet. Also do not plug or unplug the AC adapter and other connectors with a wet hand.
- Do not use the USB cable if it is damaged.
- Do not swing or throw the main body.
- Always supply power within the rated voltage range (100 to 240 V AC) of the AC adapter.
- Inspect the AC adapter, household power outlet, and the recharging terminals periodically to ensure that they are free of accumulated dust.
- Insert the plug of the AC adapter into the power outlet all the way.
- Hold the handle as shown on the right when carrying the main body.

CAUTION

- Do not place the product on an unstable or tilted surface.
- Do not leave the product outdoors for a long period to avoid damage from weather and strong sunlight.
- Do not hold two products together.
- When the product is not to be used for a long period, disconnect the AC adapter and USB cable.
- Use and store the product under an ambient temperature between 0°C and 40°C.

2 Package Contents and Nomenclature

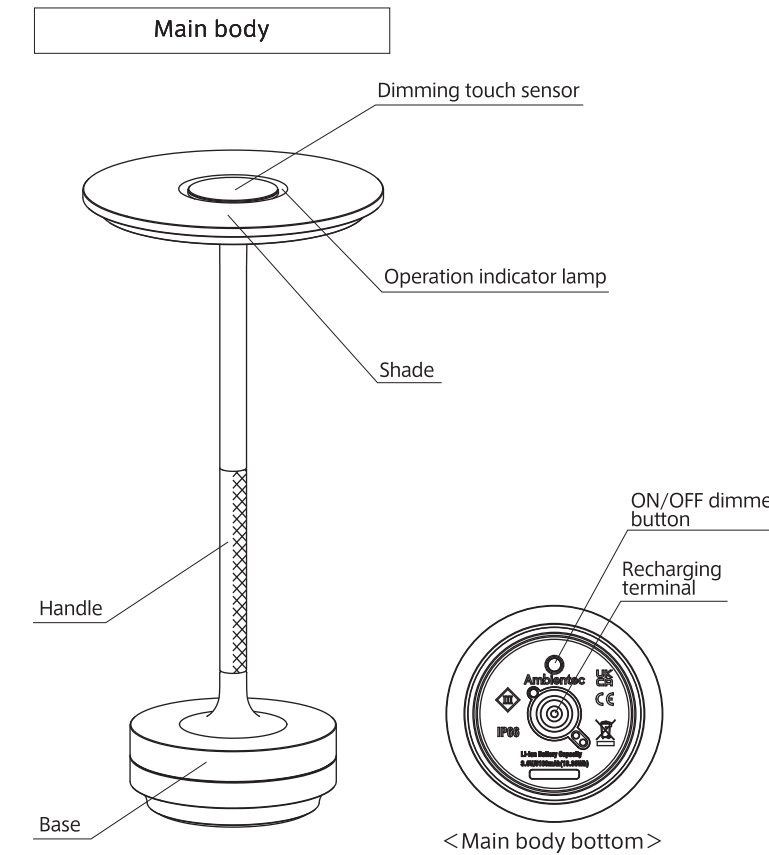

3 Before Using the Product

[1] External appearance

< TURN Stainless Steel >

- High-grade material with excellent corrosion resistance property helps maintain the condition of the product's surface for the long term.
- Minor processing marks may be present on the surface.

< TURN Brass >

- To reduce changes in the external color due to the normal corrosion of brass, a special coating has been applied to protect the surface of the product.
- The color may be slightly uneven and minor machining marks may be present on the surface.

[2] Connecting and charging the charger stand

- Connect the smaller connector (Type-C side) of the USB cable to the USB connection terminal on the charger stand (①).
Note: Although a commercially available USB Type-C cable can also be used, it may sometimes not be used depending on its configuration.

- Connect the larger connector (USB side) of the USB cable to the AC adapter (②) and plug the AC adapter into the wall outlet (③).
Note: Be sure to use the provided AC adapter (AMB-AC02) to charge the product.

- Place the main body on the charger stand. Charging starts, and the operation indicator lamp illuminates (④). When charging is complete, the operation indicator lamp goes out. To turn the light on and off while charging the product, use the dimming touch sensor. (If the LED on the main body is lit, it goes out when the main body is placed on the charger stand.)

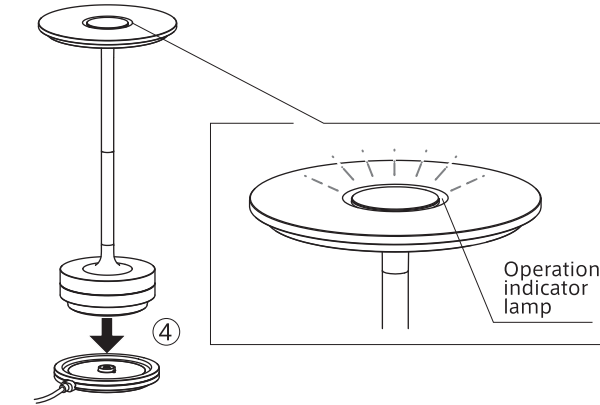

[3] Error warning

If the product detects heat generation from the battery and control circuit board or an abnormality in the power supply, the protection function may be activated, in which case the operation indicator lamp starts blinking and charging is not possible. Should this be the case, remove the main body from the charger stand, wait for a while, and replace the main body on the charger stand to resume charging.

4 USB AC Adapter

< How to attach the plug >

- While pushing the plug into the plug mount on the AC adapter's main body, slide the plug towards the PUSH button until it clicks. The mounting direction of the plug can be changed by 90 degrees in 4 ways to suit the location of use.

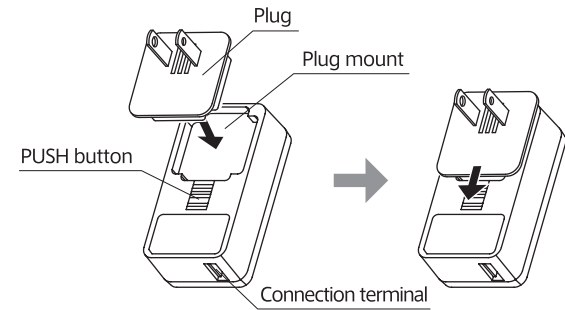

In case the AC adapter does not work

CAUTION

- If the plug is not securely attached to the AC adapter's main body, the AC adapter will not work. As a result, it may not be possible to charge the battery, adjust the brightness, or turn on the light.

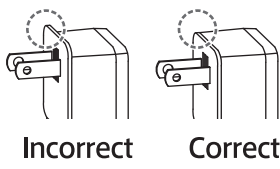

< How to detach the plug >

- While pushing the PUSH button, slide the plug away from the PUSH button and pull it out.

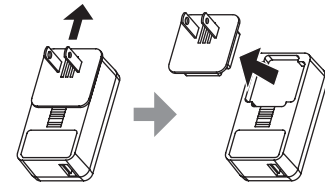

If only the plug remains attached to the wall outlet, reattach the AC adapter's main body to the plug in the order shown on the right and then remove the AC adapter from the wall outlet.

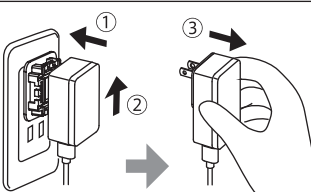

WARNING

- Never use a metallic tool to remove the plug from the wall outlet.
- Do not touch the electrical contacts; electrical shock may result.

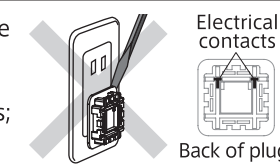

5 Operation

[1] Activating the operation of the dimming touch sensor

The dimming touch sensor is deactivated when the product is shipped from the factory.

Press the ON/OFF dimmer button on the bottom of the product's main body to activate the operation of the dimming touch sensor.

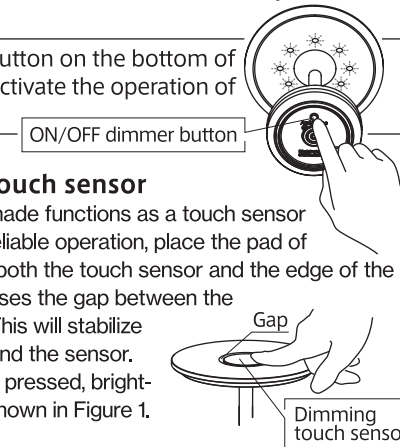

[2] Using the dimming touch sensor

- The center of the top of the shade functions as a touch sensor to adjust the brightness. For reliable operation, place the pad of your finger simultaneously on both the touch sensor and the edge of the shade so that your finger crosses the gap between the touch sensor and the shade. This will stabilize contact between your finger and the sensor.
- Every time the touch sensor is pressed, brightness is adjusted in the order shown in Figure 1.

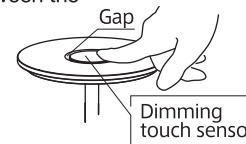

[Figure 1]

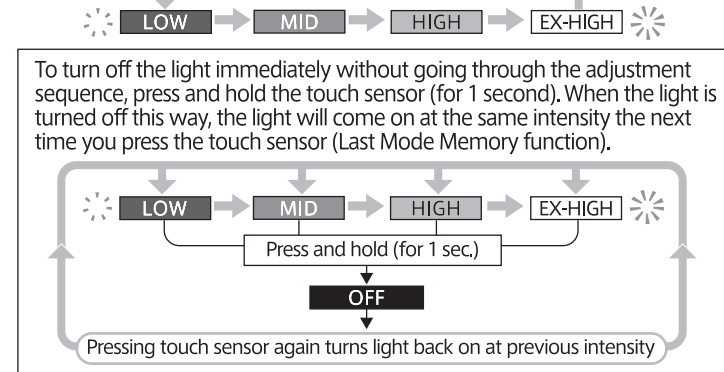

[3] Operation using the ON/OFF dimmer button

- Every time the ON/OFF dimmer button on the bottom of the main body is pressed, brightness is adjusted in the order shown in Figure 1.

How to deactivate the dimming touch sensor

When the product is to be stored or transported, deactivate the dimming touch sensor to prevent malfunction. Press and hold the button (for 2 seconds). The light will illuminate once at LOW intensity and then go out. Touch sensor operation will be disabled.

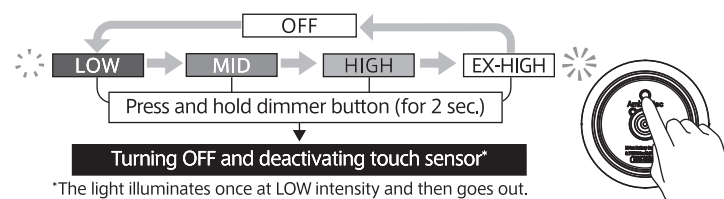

6 Dustproof and Waterproof Specifications

- The main body is both dustproof and waterproof (IP66* equivalent) but should not be used underwater. Do not put it in a bathtub or other water container. NOTE: Indicates protection from dust and high-pressure water jets from any direction.

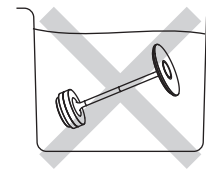

- The charger stand and AC adapter are not waterproof. Make sure they don't get wet.

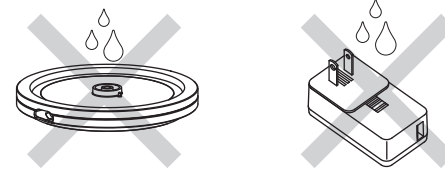

- If the product is used outdoors or in a bathroom, it will become inoperable if water gets on the dimming touch sensor. (The light goes out as soon as water is detected and then goes on again automatically at the previous intensity.) If this happens, operate the product using the ON/OFF dimmer button on the bottom of the main body.



- Once the dimming touch sensor has dried off, it will be operable again. To ensure that it is completely moisture-free, wait long enough for all moisture to evaporate or wipe off moisture in the gap around the operation indicator lamp using a cotton swab or dry soft cloth.

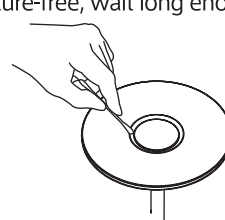

Be sure to adhere to the following cautions when using the product in a bathroom or similar environment

CAUTION

- Do not leave the product for a long time in a high-temperature, high-humidity bathroom or sauna.
- Do not place the product on a poorly drained bathroom floor or similar environment.

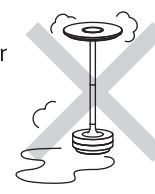

7 Care and Maintenance

To keep this product in optimal condition, please follow these maintenance guidelines.

- Turn off the power and disconnect the attached cable before cleaning the product.

- If the dimming touch sensor is dirty, wipe it with a cotton swab or soft, lint-free cloth moistened with water.

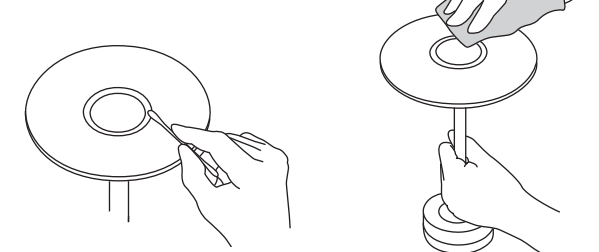

CAUTION

- Do not use a liquid spray cleaner, solvent such as benzine or thinner, or polishing agent to clean the product. Doing so may scratch the surface, reduce transparency and glossiness, and cause the surface coating to peel.
- Do not use alcohol to clean the product using brass material. Doing so may cause the special coating to peel.

- If the terminal or silicone sheet (black sheet around the terminal) on the bottom is dirty, wipe it with a moistened, soft, lint-free cloth. When doing this, place a cloth or soft material underneath to protect the shade.
- If dirt or dust gets in the terminal on the charger stand, carefully remove with a cotton swab or similar soft object. Do not use a metallic tool such as tweezers.

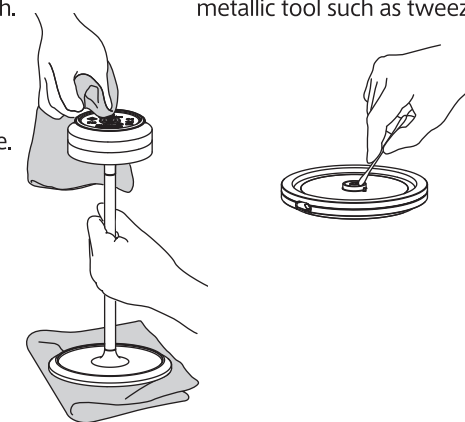

8 Disposing of This Product

This product uses a rechargeable lithium-ion battery that contains recyclable rare earth metals. Before disposing of the product, remove the battery and dispose of it according to local regulations.

- Be sure to keep the light on until it goes out. This will allow the battery to discharge completely.
- Turn the bottom of the base counterclockwise to remove it. Be careful not to break the lead wire by pulling it forcibly.

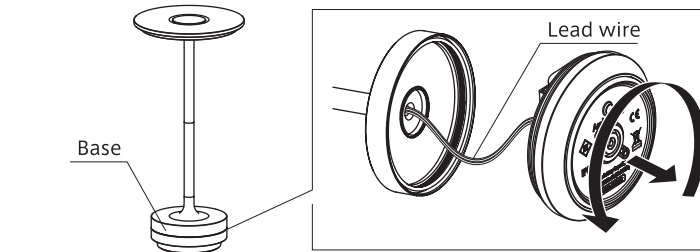

DANGER

- Never open the base except when you are going to dispose of the product.

- Pull out the connector inside the base as shown in the figure below.
- Using a precision Phillips screwdriver, remove the 4 screws that fix the battery in the base and take the battery out of the base.

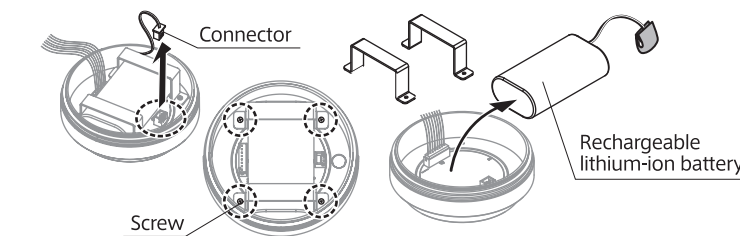

- Affix the connector with adhesive tape for insulation and dispose of the removed battery in accordance with local regulations.

9 Product Specifications

Product name	TURN Stainless Steel	TURN Brass	TURN Aluminum Black	
Product code	TN001-01SS	TN001-01BS	TN001-01AB	
Main materials	Main body/Charger stand	Stainless steel	Brass	Aluminum
	Other	Polycarbonate, ABS, silicone rubber, etc.		
Surface treatment	Main body/Charger stand	No coating	Clear coating	Anodizing (Black)
	Dimensions (mm)	Main body	Outer diameter: 130	Height: 275
Charger stand		Outer diameter: 89	Height: 12	
Weight(g)	Main body	1190	1240	530
	Charger stand	180	190	80
Light source	LED ^{1,2}			
Color rendering index	Ra 95 or more			
Dimming level	LOW	MID	HIGH	EX-HIGH
Battery run time (h)	150	38	12	5
Power consumption (W)	0.1	0.5	1.2	3.5
Illuminance (lx)	16	140	400	1200
Color temperature (K)	1800	2300	2400	2500
Recharging time	Approx. 6 hours ³			
Recharging cycle	Approx. 500 times ⁴			
Power supply	Rechargeable lithium-ion battery, 3.6 V / 5100 mAh			
Water-proofing	Main body	IP66 ⁵ equivalent		
	Charger stand	Not waterproof		
Operating temperature (°C)	0 to 40			

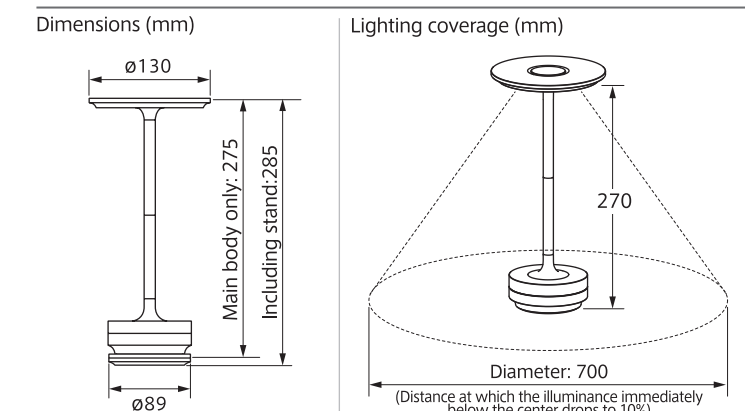

¹ The brightness of the LED elements decreases by about 70% after about 40,000 hours of use.
² The color and brightness of each individual LED element's light varies even when used in a light source with the same product code.
³ Varies depending on operating conditions and environments.
⁴ Applies when the battery performance drops below 50%.
⁵ Indicates protection from dust and high-pressure water jets from any direction.