

# Ambientec

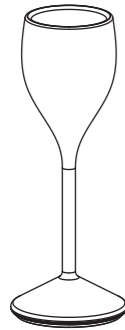

**SAMBA-M**  
Shine Kuramata

SAMBA-M  
SB-01

## Instructions

Thank you for purchasing the Ambientec SAMBA-M. Please read these instructions thoroughly before using the product.

### Contents

- 1 Safety Precautions
- 2 Package Contents and Nomenclature
- 3 Before Using the Product
- 4 Operation
- 5 Dustproof and Waterproof Specifications
- 6 Care and Maintenance
- 7 Product Specifications

Ambientec Corporation  
<https://ambientec.co.jp/>

## 1 Safety Precautions

- To use the product correctly and safely, be sure to read the Safety Precautions before use. The Safety Precautions include critical information for safety. Be sure to heed them.
- The following symbols indicate the degree of risk or damage that may result if the information given after each symbol is ignored and the product is used improperly.

<b>⚠ DANGER</b>	Indicates an imminently hazardous situation which, if not avoided, will result in death or serious injury.
<b>⚠ WARNING</b>	Indicates a potentially hazardous situation which, if not avoided, could result in death or serious injury.
<b>⚠ CAUTION</b>	Indicates a potentially hazardous situation which, if not avoided, may result in minor/moderate injury or equipment damage.

If the product is used improperly and any of the following **DANGER**, **WARNING**, or **CAUTION** information is ignored, there is potential for fire, heat generation, damage, or leakage that may cause burns, injury, or loss of sight.

<b>⊘</b>	Indicates “prohibited” actions that must not be performed.
<b>!</b>	Indicates “compulsory” actions that must be performed.

### ⚠ DANGER

- ⊘ Do not put the product in a fire or heat it in an oven.
- ⊘ Do not expose the product to high temperatures or leave it in a place where it is subject to direct sunlight.
- ⊘ Do not place the product within reach of infants and children.
- ⊘ Do not open or modify the product.
- ⊘ Do not apply an impact to the product by dropping it, throwing it, etc.
- ⊘ Do not look directly at the LED light source when it is illuminated.
- ! Disconnect the product immediately if you notice smoke or smell something burning.

### ⚠ WARNING

- ⊘ Do not place the product in an area exposed to direct sunlight; otherwise, the product’s glass shade could focus the sun’s rays and cause a fire.
- ⊘ Do not short-circuit the recharging terminal of the main body or charger stand with a metal pin or other metallic object.
- ⊘ Do not cover the product with cloth, paper, or any other easily flammable material.
- ⊘ Keep water and other liquids away from the AC adapter and charger stand and do not use them while they are wet. Also do not plug or unplug the AC adapter and other connectors with a wet hand.
- ⊘ Do not use the USB cable if it is damaged.
- ⊘ Do not swing or throw the main body.
- ⊘ If the glass shade breaks, do not touch any of the broken pieces with bare hands.
- ! When using the optional AMB-AC02 USB AC adapter, use it at the rated voltage (AC100–240V).
- ! Inspect the AC adapter, household power outlet, and the recharging terminals periodically to ensure that they are free of accumulated dust.
- ! Insert the plug of the AC adapter into the power outlet all the way.
- ! When carrying the main body, hold the stem while supporting the base on the palm of your hand as shown on the right.



### ⚠ CAUTION

- ⊘ Do not place the product on an unstable or tilted surface.
- ⊘ Do not leave the product outdoors for a long time.
- ⊘ Do not remove the glass shade.
- ⊘ Do not use the product as drinkware.
- ⊘ Do not put the product in a dishwasher.
- ! When the product is not to be used for a long period, disconnect the AC adapter and USB cable.
- ! Use and store the product under an ambient temperature between 0°C and 40°C.

## 2 Package Contents and Nomenclature

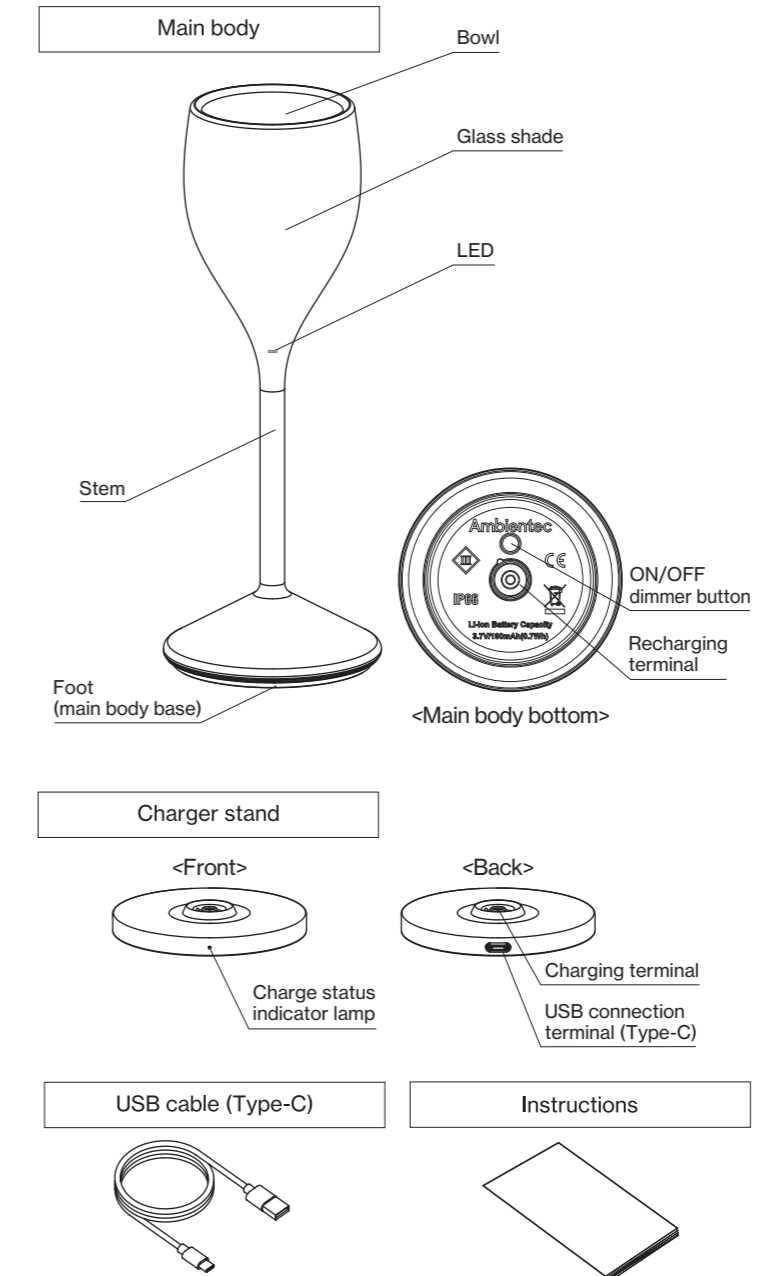

- Thanks to widespread use of computers and mobile phones, most people today already possess a USB-compatible AC adapter. To minimize waste, AC adapter is not provided with this product.
- In addition to Ambientec’s optional AC adapter (AMB-AC02), you can also use a USB AC adapter compatible with DC 5V/≥1A output.

## 3 Before Using the Product

Our master craftsmen carefully finish every glass shade we make for this product by hand. Consequently, no two shades are exactly alike and the glass may also feature bubbles and distortions depending on the product. However, we ship only those shades that meet our quality standards.

### [1] Connecting the charger stand and charging the main body

- Connect the smaller connector (Type-C side) of the USB cable to the USB connection terminal on the charger stand (①).
- Note:** Although a commercially available USB Type-C cable can also be used, it may sometimes not be used depending on its configuration.
- Connect the larger connector (USB side) of the USB cable to the AC adapter (②) and plug the AC adapter into the wall outlet (③).
- Note:** When an AC adapter with output of 5 V DC, 1 A or less is used, charging may take longer or may not even be possible. Always use a reliable, manufacturer-warranted AC adapter with output of 5 V DC, 1 A or more if possible. Any damage or malfunctions that may occur when an unreliable AC adapter is used and that are not caused by this product, may void our warranty.
- Place the main body on the charger stand. Charging starts, and the charge status indicator lamp lights at fixed intensity. When charging starts, the LED on the main body goes out automatically (④). When charging is complete, the charge status indicator lamp goes out. The LED on the main body automatically illuminates in the LOW mode when the main body is removed from the charger stand (⑤).

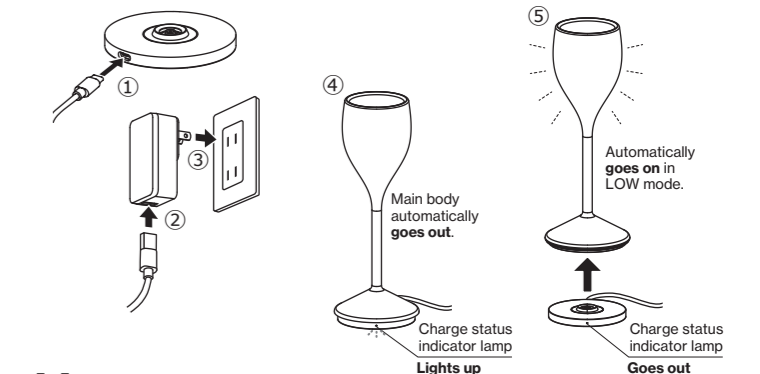

### [2] Error warning

If the product detects heat generation from the battery and control circuit board or an abnormality in the power supply, the protection function may be activated, in which case the charge status indicator lamp starts blinking and charging is not possible. If this happens, remove the main body from the charger stand, wait for a while, and then replace the main body on the charger stand to resume charging. Normal operation should be restored.

## 4 Operation

●Every time the ON/OFF dimmer button on the bottom of the main body is pressed, brightness is adjusted in the order of LOW →MID → HIGH →OFF.

●Lighting durations: LOW(24 hours)→MID(12 hours)→HIGH(6 hours)\*

\*These lighting durations are for reference only and will decrease gradually over time as the product is used. To replace the built-in battery, contact your Ambientec dealer. They will replace it for a fee.

**Note:** When the battery level becomes low, the LED on the main body may start blinking. This is not a malfunction.

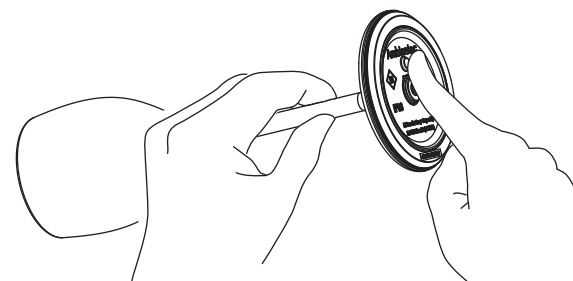

## 5 Dustproof and Waterproof Specifications

The glass shade has a waterproof double-walled construction. So you can put water in the bowl on the top and turn the light on to enjoy the gentle shimmering of water.

●The main body is both dustproof and waterproof (IP66\* equivalent) but should not be used underwater. Do not put it in a bathtub or other water container.

\*Indicates protection from dust and high-pressure water jets from any direction.

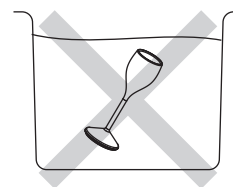

●The charger stand is not waterproof. Make sure it doesn't get wet.

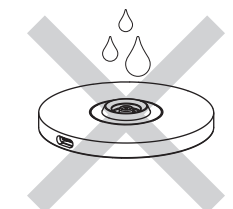

**Be sure to adhere to the following cautions when using the product in a bathroom or similar environment**

### CAUTION

⊘ Do not leave the product for a long period in a high-temperature, high-humidity bathroom or sauna.

⊘ Do not place the product on a poorly drained bathroom floor or similar environment.



## 6 Care and Maintenance

To keep this product in optimal condition, please follow these maintenance guidelines.

⚠ Turn off the power and disconnect the attached cable before cleaning the product.

●Gently wipe the glass shade and metallic parts with a soft, lint-free cloth.

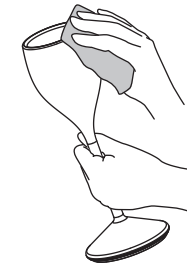

●If the glass shade is dirty, clean it with a cloth dampened with water or diluted detergent. Wipe off any moisture with a soft, dry lint-free cloth.

### CAUTION

⊘ Do not use a liquid spray cleaner, solvent such as benzine or thinner, or polishing agent to clean the product. Doing so may scratch the surface, reduce transparency and glossiness, and cause the surface coating to peel.

⚠ This product is made of extremely fragile glass. Handle it with care. Avoid striking it, tripping over it, or dropping it.

⚠ This product is not drinkware. Do not put it in or soak it in soap water.

●If the terminal or silicone sheet (black sheet around the terminal) on the bottom is dirty, wipe it with a moistened, soft, lint-free cloth. When doing this, place a cloth or soft material underneath to protect the glass shade.

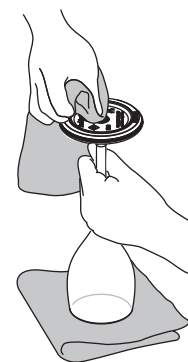

●If dirt or dust gets in the terminal on the charger stand, carefully remove with a cotton swab or similar soft object. Do not use a metallic tool such as tweezers.

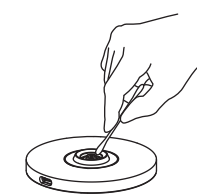

## 7 Product Specifications

Product name	SAMBA-M		
Product code	SB-01		
Light source	LED <sup>*1, *2</sup>		
Dimming level	LOW	MID	HIGH
Battery run time (h)	24	12	6
Power supply	Rechargeable lithium-ion battery, 3.7 V / 190 mAh		
Recharging time	Approx. 3 hours <sup>*3</sup>		
Recharging cycle	Approx. 500 times <sup>*4</sup>		
Water-proofing	Main body	IP66 <sup>*5</sup> equivalent	
	Charger stand	Not waterproof	
Main materials	Main body	Glass <sup>*6</sup> , aluminum, silicone rubber, ABS	
	Charger stand	Aluminum, silicone rubber, ABS	
Surface treatment	Main body base	Baked paint	
	Charger stand	Anodized oxide coating	
Dimensions (mm)	Main body	Outer diameter: 80	Height: 212
	Charger stand	Outer diameter: 73	Height: 8
Weight(g)	Main body	210	
	Charger stand	65	
Operating temperature (°C)	0 to 40		

Dimensions (mm)

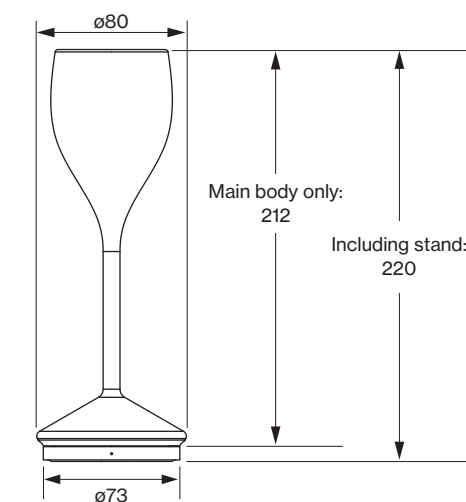

\*1 The brightness of the LED elements decreases by about 70% after about 40,000 hours of use.

\*2 The color and brightness of each individual LED element's light varies even when used in a light source with the same product code.

\*3 Varies depending on operating conditions and environments.

\*4 Applies when the battery performance drops below 50%.

\*5 Indicates protection from dust and high-pressure water jets from any direction.

\*6 It is made of glass, but is very delicate structure. Please pay much attention to handle it.

Design and specifications are subject to change without notice.