

HIGH PRESSURE WASHER

SP11Y

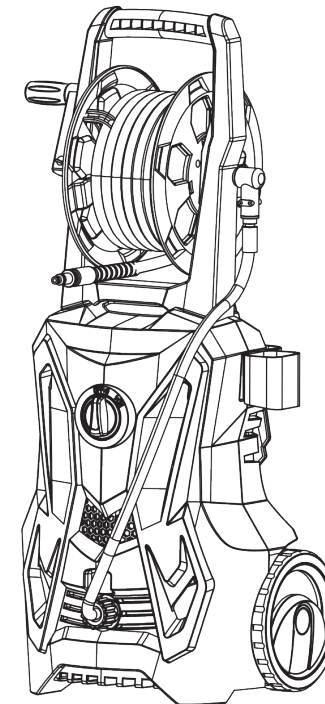

CAUTION : Do not use this device before reading the instructions.

13. EU Declaration of Conformity

EU Declaration of Conformity

We herewith declare,

That the following product complies with the appropriate basic safety and health requirements of the EC Directive based on its design and type, as brought into circulation by us.

In case of alteration of the product, not agreed upon by us, this declaration will lose its validity.

Product Type: HG24P , HG14P, HG13S

Applicable EC Directives

MD certificate and test report

EN 60335-1:2012+A11:2014+A13: 2017+A1: 2019+A2: 2019+A14: 2019 EN 60335-2-79:2012

EMC certificate and test report

EN 55014-1:2017 EN 55014-2:2015 EN IEC 61000-3-2:2019 EN 61000-3-3:2013+A1:2019

EMF certificate and report if applicable EN 62233:2008

ROHS directive:2011/65/EU

Others according to relative Standards, e.g., food contact, RED etc PAHS test report
Intertek test report 200400127HZH-001-PAH

Date/Authorized Signature:

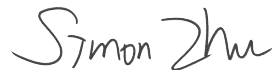

Title of Signatory: sales manager

1.SAFETY INSTRUCTIONS

- This appliance has been solely designed for private outdoor use and not for commercial use. Keep the appliance away from heat, direct sunlight, moisture and rain, ice and sharp edges.
 - Do not allow anybody who has not been trained to operate the machine without reading the instruction manual.
 - **WARNING:** High pressure washers must not be used by children or untrained persons.
 - Before starting your machine, carefully check for defects. If you find any, do not start your machine and contact your local distributor.
 - In particular, ensure that the electric cable insulation is in perfect condition and free of cracks. If the electric cable is damaged, an approved local service center must replace it.
 - **WARNING:** High pressure washers can be dangerous if use incorrectly. The washer must not be directed towards persons, electrical equipment connected to the mains or the washer itself.
 - **WARNING:** Disconnect the appliance from the power supply before doing any maintenance.
 - **CAUTION:** To ensure the safety of the washer, only use the spare parts supplied or approved by manufacturer.
 - Do not use the washer if the power cord or important parts are damaged.
 - Do not use the washer with wet hands. If the washer is damp or wet, unplug it immediately. Do not place it in water.
 - The tires and valves on the tires can be damaged by the high pressure jet.
 - Never use the high pressure washer in an environment with a danger of explosion.
 - Do not use the high pressure washer to clean surfaces which contain asbestos at high pressure.
 - This high pressure washer must not be used in temperatures below 0 ° C, or 32 F.
 - **CAUTION:** The hose, high pressure couplings, and other accessories are important to the safety of the machine. Only hoses, accessories and couplings recommended by the manufacturer fit the appliance.
 - **WARNING:** Inadequate extended cords may be dangerous. Cords must always be completely unwound to avoid letting the cord overheat.
 - If an extension cord is used, the plug and socket must be waterproof and conform to the requirements below regarding the length and dimensions of the cord.
 - 1,0 mm² max. 12,5 m
 - 1,5mm² max. 20 m
- If the power cord is damaged, it must be replaced by the manufacturer, their

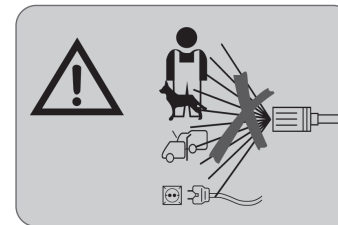

1. SAFETY INSTRUCTIONS

- 1,0 mm² max. 12,5 m
- 1,5mm² max. 20 m

If the power cord is damaged, it must be replaced by the manufacturer, their

- service agent or a qualified professional in order to avoid any danger.
- **WARNING:** The high pressure washer is not designed to be used by persons with reduced physical, sensory or mental capacities, or those who lack experience or knowledge.
- **WARNING:** Do not allow children to operate.
- **CAUTION** - Risk of explosion - don't spray flammable liquids, do not direct the jet towards flammable liquids.
- **WARNING:** Water that has circulated in the anti-back flow system is not considered drinkable.
- **WARNING:** Do not use the appliance if the power cord or important parts of the appliance are damaged.
- **WARNING:** If you have an extension cord, it must be waterproof.
- **WARNING:** When you switch on the machine, a recoil movement will be produced due to the force of the water jet. Use both of your hands to control the handgun. Wear suitable protective clothing and safety gloves when using the high pressure washer.
- In case of accidental contact with the detergent, wash with water at once. If the liquid comes into eyes, please seek medical assistance (the detergent can cause irritations or burns).
- In the event that the appliance breaks down, do not attempt to repair it yourself but contact a professional technician to avoid any danger.

- Main power connection

The following must be observed when connecting the high pressure washer to the power supply:

- It is recommended that the power supply for the high pressure washer should comprise a residual current-device which interrupts the current if the leaked current exceeds 30 mA for 30ms.
- **CONNECTING TO THE WATER NETWORK WARNING**
- According to the current guidelines, the high pressure washer is forbidden to be operated without a system separator on the potable water system. Water that passes through a system separator is classified as non-potable.
- **WARNING:** Always connect the system separator to the water supply and never directly to the device!



- **GROUND FAULT CIRCUIT INTERRUPTER PROTECTION**

12. WEEE - WASTE OF ELECTRIC AND ELECTRONIC EQUIPMENT

The symbol on the product or on its packing indicates that this product may not be treated as household waste. Instead it shall be handed over. To the applicable collection point for the recycling of electrical and electronic equipment. By ensuring this product is disposed of correctly, you will help prevent potential negative consequences for the environment and human health, which could otherwise be caused by inappropriate waste handling of this product. For more detailed information about recycling of this product, please contact your local city office, your household waste disposal service or the shop where you purchased the product.

11. WARRANTY

Stream[®]

WARRANTY

Your warranty includes:

10 Days Money Back Guaranty

Within the first 10 days of your purchase, you are allowed to return your product for a full refund.

30 Days

We will replace the defective unit due to manufacturer fault with a new one. (You will receive extra 30 days warranty if you register on our website.)

90 Days

Within 90 days, we will provide timely and effective online after-sales service after your purchase.

Please be noted that accessories are free, not included.

The manufacturer agrees to replace parts identified as defective by the designated distributor. The manufacturer does not accept responsibility for the replacement of the machine, in whole or in part, and / or ensuing damage.

The warranty does not cover breakdowns due to:

- Insufficient maintenance.
- Abnormal assembly, adjustment or operations of the product.
- Parts subject to normal wear and tear.

The warranty does not extend to:

- Shipping and packaging costs.
- Using the tool for a purpose other than that for which it was designed.
- The use and maintenance of the machine done in a manner not described in the user manual.

Due to our policy of continuous product improvement, we reserve the right to alter or change specifications without notice. Consequently, the product may be different from the information contained therein, but a modification will be undertaken without notice if it is recognized as an improvement of the preceding characteristic.

1. SAFETY INSTRUCTIONS

- SERVICING OF A DOUBLE-INSULATED APPLIANCE
- In a double-insulated product, two systems of insulation are provided instead of grounding. Grounding means are not provided for a double-insulated product, nor should grounding means be added to the product. Servicing a double-insulated product requires extreme care and knowledge of the system,

and should only be done by qualified service personnel. Replacement parts for a double-insulated product must be identical to the original parts. A double-insulated product is marked with the words "Double Insulation" or "Double Insulated".



The symbol may also be marked on the product.

2. PRODUCT OVERVIEW

SP11Y

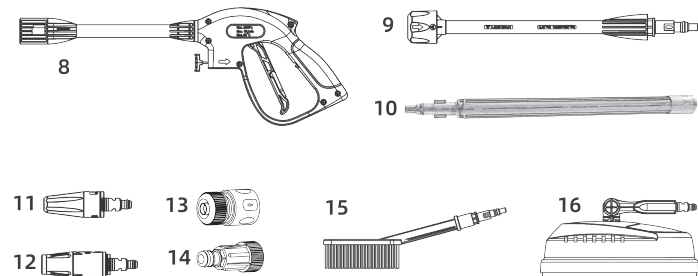
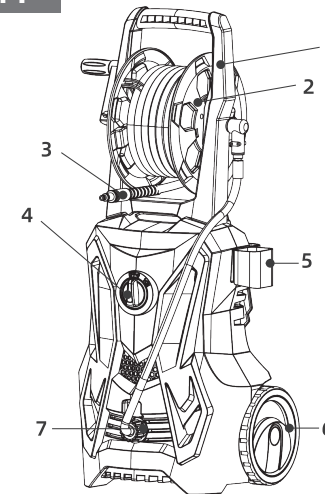

3. PRODUCT OVERVIEW

No.	Model	JX0791901
1	Handle	√
2	Coil with hose	√
3	High pressure hose	√
4	On/off switch	√
5	Gun holder	√
6	Wheel	√
7	Water inlet	√
8	Washing gun	√
9	Lance	√
10	Extend lance	√
11	Turbo nozzle	√
12	Nozzle	√
13	1/2HPC Connector	√
14	Inlet filter	√
15	Fix brush	√
16	Patio cleaner	√

4. TECHNICAL DATA

Machine code	SP11Y
Permissible pressure (Max.)	160Bar
Inlet(Max)	0.3MPa
Max.flow	7.5L/min
Rated voltage	220V
Rated frequency	60Hz
Degree of Protection	IPX5
Protection class	II
Sound power level	93dB(A)
Water temperature Max.	104°F/40°C
N.W	10.4Kg

10. BREAKDOWN SERVICE

Symptom	Probable Cause	Recommended action
The machine will not start	The machine is not plugged-in	Plug the machine in
	Faulty receptacle	Try another receptacle
	The fuse has blown	Replace the fuse Unplug other appliances
	Faulty extension cord	Try without the extension cord
Fluctuating pressure	The pump is drawing in air	Check that hoses and connections are airtight.
	Valves dirty, worn or sticking	Contact your service centre
	The water supply is not sufficient	Increase water pressure, check for blockages and / or change the large pipe.
	Pump seals worn	Contact your nearest service center
The machine stops	The fuse has blown	Replace the fuse
	Incorrect mains voltage	Unplug other appliances Check that the mains voltage corresponds to the specifications on the nameplate
	Thermal sensor activated	Leave the machine to cool for 5 mins
	Partially blocked jet	Clean the jet with a needle and by spraying water rearwardly through the jet
Fuse blown	Fuse too small	Replace it with a fuse with higher amp consumption than the washer.
	Increase in the amperage	Try without the extension cord
Pulsing machine	Air in inlet hose / pump	Allow machine to run with open trigger until regular working pressure resumes.
	Inadequate supply of water generated	Increase water pressure, check for blockages and / or change the large pipe.
	Partially blocked jet	Clean the jet with a needle and by spraying water rearwardly through the jet
	Water filter blocked	Clean the filter
	Folded pipe	Unfold the pipe
The machine turnson and off by itself	Pump fuse and/or trigger out of order	Contact your nearest service centre
	No water supply	Connect the inflow water.
The machine is on but no water comes out	Water filter blocked	Clean the filter
	Blocked jet	Clean the jet with a needle and by spraying water rearwardly through the jet

9. MAINTENANCE, CLEANING AND REPAIR

WARNING! Always disconnect the electrical plug from the power supply prior to maintenance or cleaning.

To ensure a long and problem free working life, please take the following advice:

Wash the water hose, high pressure hose, spray lance and other accessories before mounting.

Clean the connectors of dust and sand.

Rinse the detergent spraying attachment after usage.

Clean the nozzles.

Any repair should always be made in an authorized workshop with original spare parts.

9.1 Cleaning of inlet filter

Clean the water inlet filter regularly once a month or more frequently according to use.

Carefully to take off the filter with a screwdriver and clean it. Check that it is intact before re-mounting it.

The inlet filter must always be fitted inside the water inlet pipe to filter out sand, limestone and other impurities, as they will damage the pump valves.

CAUTION: Failure to fit the filter will invalidate the warranty

9.2 Cleaning of air vents

The machine should be kept clean so as to let cooling air pass freely through the machine vents.

9.3 Greasing of couplings

To ensure an easy connection and that o-rings do not dry up; the couplings should be greased regularly.

5. FIRST TIME INSTRUCTIONS

This section will explain in details how to make the high pressure washer ready for use.

THERMAL SENSOR

A thermal sensor protects the motor against overloading. The machine will restart after a few minutes when the thermal sensor has cooled.

SAFETY DEVICES

The unloader valve can reduce pressure if it exceeds pre-set values. Locking device is set on gun trigger (see illustration at the beginning of

this manual): The trigger features a locking device. When the knob is activated, the trigger gun cannot be operated.

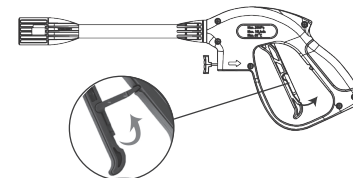

6. OPERATION INSTRUCTIONS

6.1 Connection of garden hose

Screw the water inlet coupling tight on to the water inlet. Note: The inlet filter must always be fitted in the water inlet pipe to filter out sand, lime stone and other impurities as these will damage the pump valves.

Caution: Failure to install the filter will invalidate the guarantee.

Connect the garden hose with a standard quick coupling

6.2 Mounting of high pressure hose

Attach the high pressure hose to the trigger gun and machine.

Detach the high pressure hose by pressing the pawl or button.

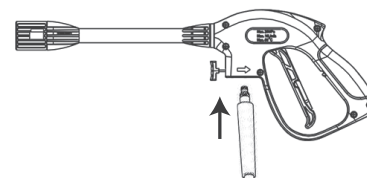

6.3 Mounting of lance and nozzle

Push the lance into the trigger gun. When inserted, turn it. Caution: Make sure the lance is properly fixed to the gun

Insert the nozzles. Caution: When insert the nozzle, the button on the nozzle should come out again. Check before activating the trigger that the nozzle is properly fixed.



6.4 Water connection

Connecting the water supply pipe. Follow your water supplier's instructions.

For connection information, please refer to the data plate/technical specifications.

Use a reinforced hose (not supplied) with standard connector with diameter: 16 mm / int. 12 mm, maximum length: 25m).

6. OPERATION INSTRUCTIONS

IMPORTANT! Only use water without any impurities. If there is a risk of sand particles in the inlet water (i.e. from your own well), an additional filter should be used.

Let the water run through the water hose before connecting it to the machine to prevent sand and dirt from penetrating the machine. Note: Check that the filter is fitted in the water inlet pipe and that it is not clogged up.

Connect the water hose to the water supply with quick connector (inlet water, max. pressure: 10 bar, max. temperature: 40°C). Turn on the water.

6.5 Start/stop of the machine

The trigger gun and lance are affected by a thrust during operation - therefore always hold it firmly with both hands.

IMPORTANT: Point the gun to the ground.

Check that if the appliance is in upright position. **NOTE:** Do not place the machine in high grass! Release the trigger lock.

Activate the trigger of the trigger gun and let the water run until all air has escaped from the water hose. Press the Start/stop switch.

Activate the trigger of the trigger gun.

Always adjust the distance and thus the pressure of the nozzle to the surface, which is to be cleaned.

Do not cover the machine during operation or use it in a room without adequate ventilation!

NOTE: If the machine is left or not used for 5 minutes, it must be switched off on the start/stop switch "O":

Press the start/stop switch "O". Disconnect the electrical plug from the socket.

Shut off the water supply and activate the trigger of the trigger gun to relieve the machine of pressure.

Lock the trigger gun. When releasing the trigger of the trigger gun, the machine automatically stops. The machine will start again when you re-activate the trigger gun.

6.6 Adjustable Nozzle

The pressure can for the adjustable nozzle be adjusted by tuning it. **WARNING:** Do not do this under operation to avoid that the hand hits the jet.



High / Low Pressure Operation

The nozzle controls the washer pressure. Push the nozzle in the closed position for high pressure operation keeping at least 30cm away from work pieces.

NOTE: No detergent will be dispensed in high pressure mode.

LOW Pressure Operation (for dispensing cleaning detergent).

Pull out the nozzle for low pressure operation. This is the required position to dispense the detergent from the built detergent reservoir.

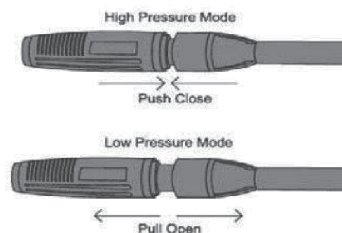

6. OPERATION INSTRUCTIONS

NOTE: Detergent needs to be diluted to achieve the most effective cleaning. It is recommended to dilute the detergent in a suitable container to the required concentration before using.

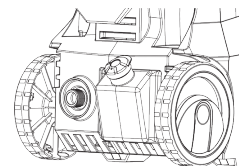

6.7 Detergent Nozzle

When you want to spray detergent, don't forget to equip the detergent nozzle.

6.8 Install indicator diagram

1) gun hook assembly:

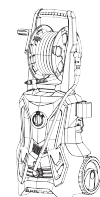

2) Handle assembly

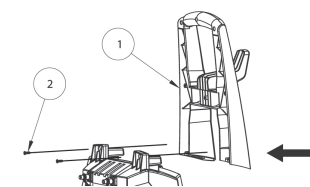

3) Quick connect structure on the machine body. All the Accessories can be stored on the machine.

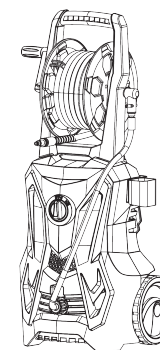

7. AFTER USE INSTRUCTIONS

The machine should be stored in a frost-free room!

Pump, hose and accessories should always be emptied of water prior to storing as follows:

Stop the machine (press the start/stop switch "O" and detach water hose, high pressure hose and nozzle)

Restart the machine and activate the trigger of the trigger gun. Let the machine run until no more water runs through the trigger gun.

Stop the machine, unplug and wind up hose and cord.

Place trigger gun, lance, nozzles and other accessories in the holders of the machine. The hook can be used for storage of the hose and cord. All accessories can be stored on the washer after using.

WARNING: Never start a frozen machine.

8. ENVIRONMENTAL PROTECTION

Old appliances contain valuable materials that can be recycled. Please arrange proper recycling of old appliances. Please dispose old appliances using appropriate collection systems.