

Respiratory ventilation products Alternate care

United States catalog



Table of contents

LTV[®] Series ventilator products3–29

EnVe[®] ventilator products30–35

ReVel[®] ventilator products36–43

LTV[®] Series ventilators



LTV Series ventilators



21102-001

LTV Series 1100 ventilator system

LTV Series 1100 ventilator, protective boots, AC adapter w/power cord, dust cover, hand strap, circuit adapter and operator manual



18984-001

LTV Series 1150 system

LTV Series 1150 ventilator, protective boots, AC adapter w/power cord, dust cover, hand strap, circuit adapter, operator manual and quick reference guide



18888-001

LTV Series 1200 system

LTV Series 1200 ventilator, protective boots, AC adapter w/power cord, dust cover, hand strap, circuit adapter, low flow oxygen adapter, operator manual and quick reference guide



18881-001

LTV Series 1200 MR Conditional ventilator system

Ventilator with protective boots, AC adapter w/power cord, dust cover, circuit adapter, low flow oxygen adapter, LTV 1200 MR Conditional floor stand, case of 5 MR-safe 15 ft circuits and operator manual

LTM™ II Graphics Monitor and accessories



17650-001

LTM II Graphics Monitor package

LTM II Graphics Monitor, LTM mounting bracket, LTM II data cable, power splitter cable, compact flash card and LTM II operator manual

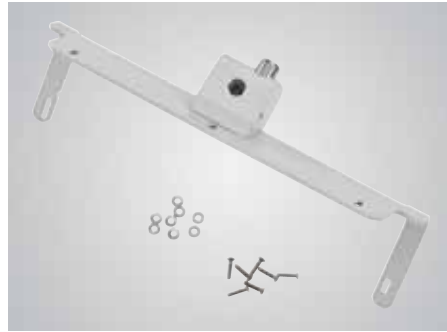

17916-001

Bracket, LTM Graphics Monitor mounting



11089

Cable, LTM data, 21 in



11089-002

Cable, LTM data, 6 ft



18093-001

Cable, power splitter, LTM II



18097-001

Stylus pen, LTM



18098-001

Card, compact flash

LTV Series circuits

LTV Series 1100, 1150 and 1200 ventilator circuits without PEEP

Single patient use (SPU) circuits, 6 ft

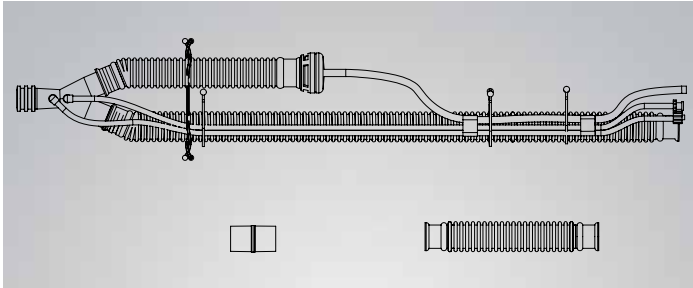

10822x10

Patient circuit w/o PEEP, 22 mm SPU (10/pkg)

1.8 m x 22 mm insp limb, wye and 61 cm x 22 mm exp limb

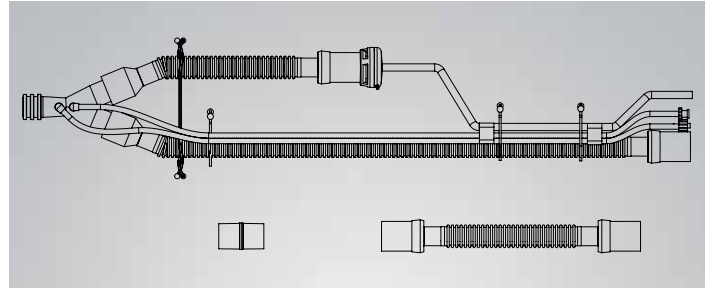

10823x10

Patient circuit w/o PEEP, 15 mm SPU (10/pkg)

1.8 m x 15 mm insp limb, wye and 61 cm x 15 mm exp limb

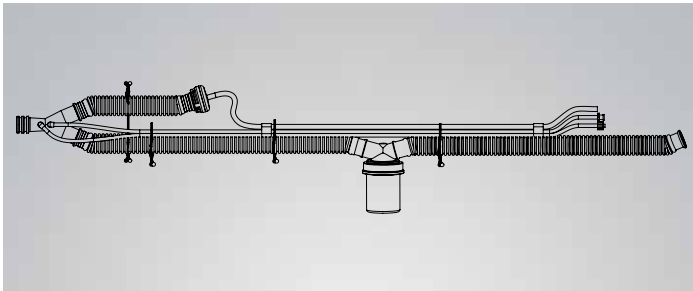

18930-001

Patient circuit w/o PEEP w/1 water trap, 22 mm SPU (10/pkg)

1.8 m x 22 mm insp limb w/water trap, temp probe port, wye and 61 cm x 22 mm exp limb

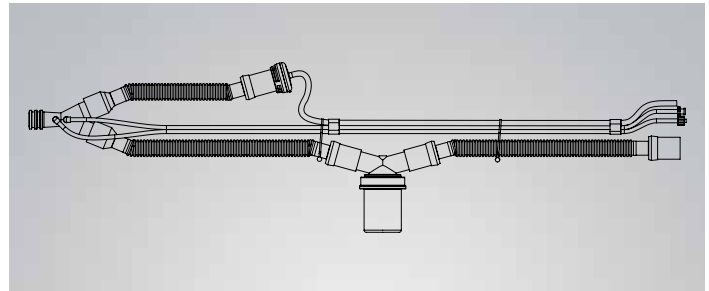

18929-001

Patient circuit w/o PEEP w/1 water trap, 15 mm SPU (10/pkg)

1.8 m x 15 mm insp limb w/water trap, temp probe port, wye and 61 cm x 15 mm exp limb

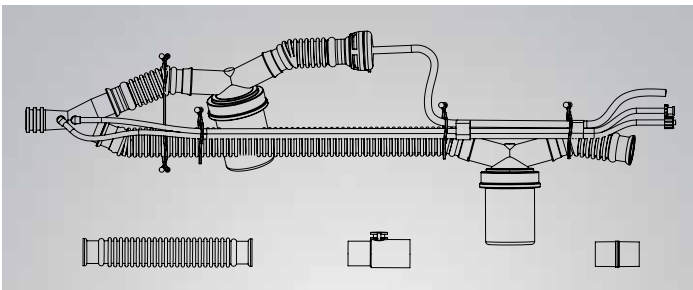

11985x10

Patient circuit w/o PEEP w/2 water trap, 22 mm SPU (10/pkg)

1.8 m x 22 mm insp limb w/water trap, temp probe port, wye and 61 cm x 22 mm exp limb w/water trap

LTV Series 1100, 1150 and 1200 ventilator circuits without PEEP (continued)

Single patient use (SPU) circuits, 6 ft

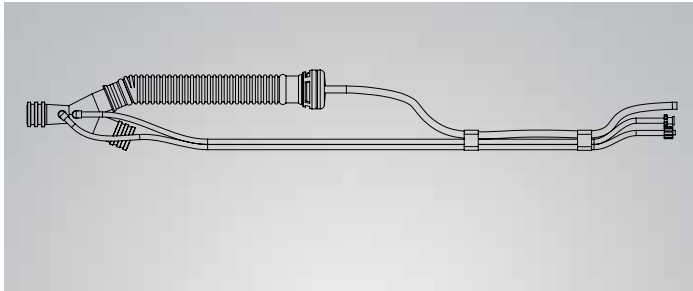

10819x10
Wye and expiratory limb w/o PEEP, 22 mm SPU, 6 ft (10/pkg)
Wye and 61 cm x 22 mm exp limb

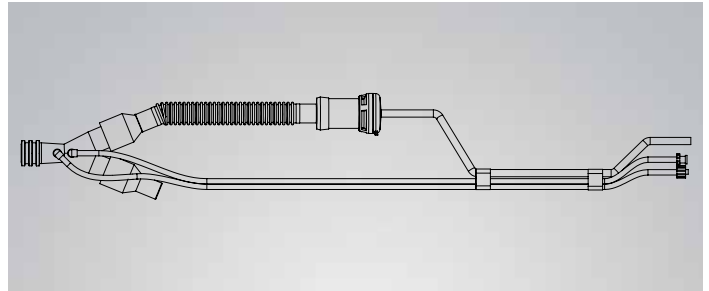

10878x10
Wye and expiratory limb w/o PEEP, 15 mm SPU, 6 ft (10/pkg)
Wye and 61 cm x 15 mm exp limb

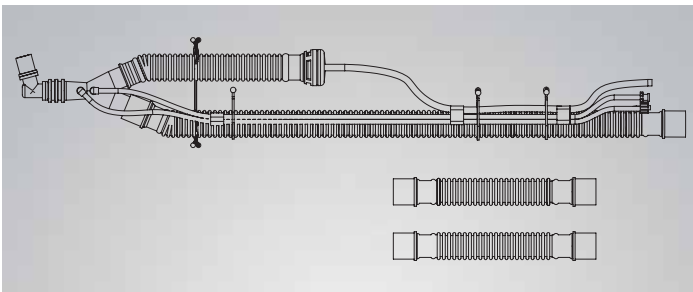

14858-001
Patient circuit w/o PEEP w/elbow, 22 mm SPU (10/pkg)
1.8 m x 22 mm insp limb, wye, elbow and 61 cm x 22 mm exp limb

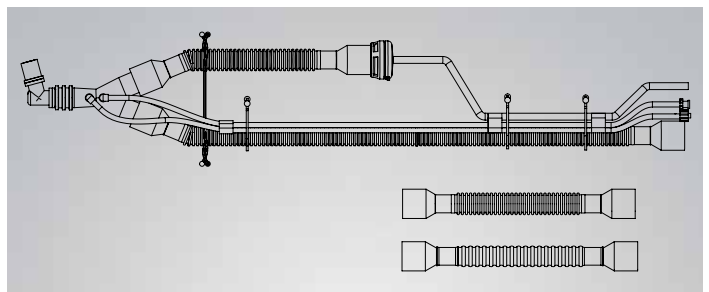

14859-001
Patient circuit w/o PEEP w/elbow, 15 mm SPU (10/pkg)
1.8 m x 15 mm insp limb, wye, elbow and 61 cm x 15 mm exp limb

SPU circuits, 12 ft

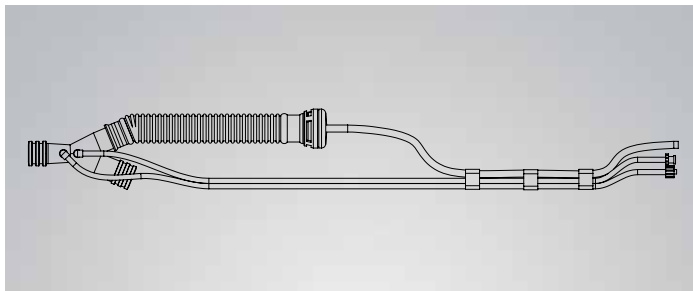

18884-001
Wye and expiratory limb w/o PEEP, 22 mm SPU, 12 ft (10/pkg)
Wye and 61 cm x 22 mm exp limb

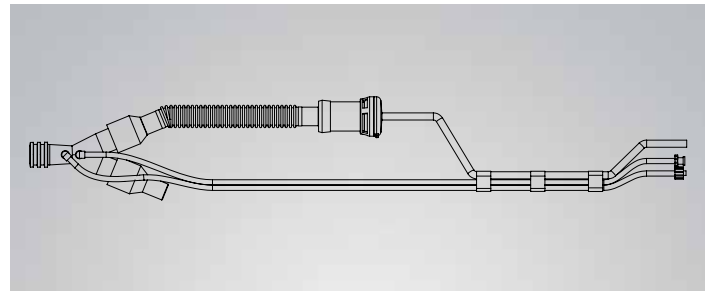

18885-001
Wye and expiratory limb w/o PEEP, 15 mm SPU, 12 ft (10/pkg)
Wye and 61 cm x 15 mm exp limb

LTV Series circuits

LTV Series 1100, 1150 and 1200 ventilator circuits without PEEP (continued)

Reusable circuits, 6 ft

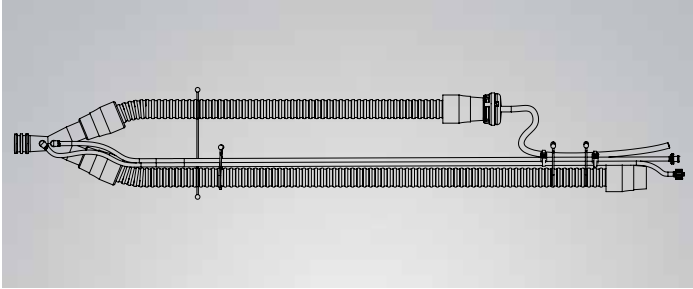

17997-001

Patient circuit w/o PEEP, 22 mm reusable (ea) (replaces 10815)

1.8 m x 22 mm insp limb, wye and 61 cm x 22 mm exp limb

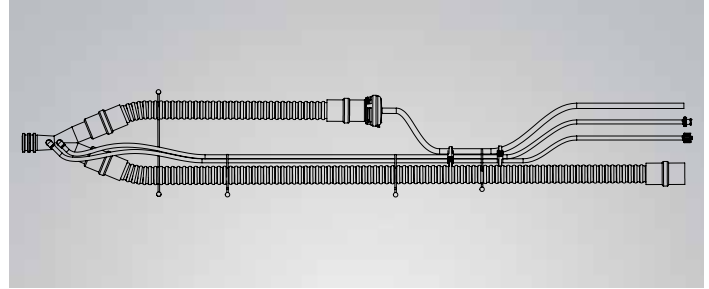

18941-001

Patient circuit w/o PEEP, 15 mm reusable (ea)

1.8 m x 15 mm insp limb, wye and 61 cm x 15 mm exp limb

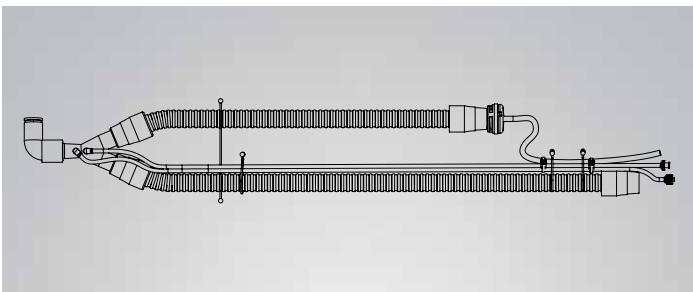

14863-001

Patient circuit w/o PEEP w/elbow, 22 mm reusable (ea)

1.8 m x 22 mm insp limb, wye, elbow and 61 cm x 22 mm exp limb

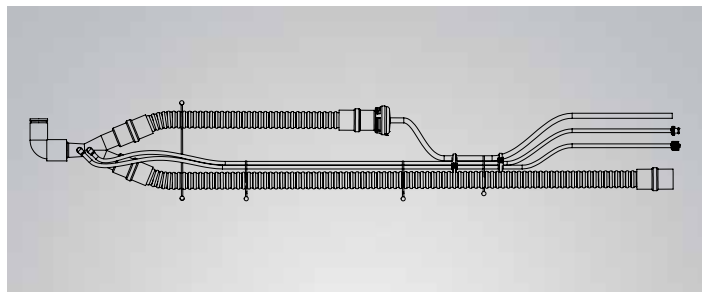

14862-001

Patient circuit w/o PEEP w/elbow, 15 mm reusable (ea)

1.8 m x 15 mm insp limb, wye, elbow and 61 cm x 15 mm exp limb

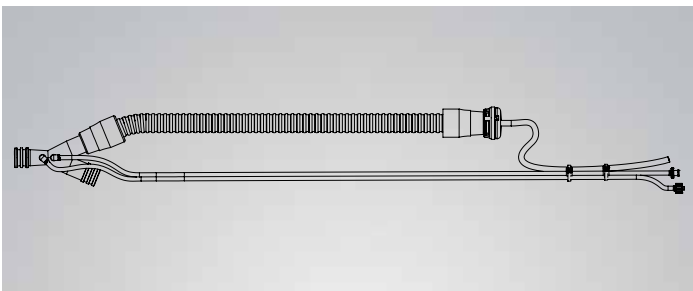

18029-001

Wye and expiratory limb w/o PEEP, 22 mm reusable (ea)

Wye and 61 cm x 22 mm exp limb

LTV Series 1100, 1150 and 1200 ventilator circuits without PEEP (continued)

SPU heated wire circuits for Fisher & Paykel humidifiers, 5.5 ft

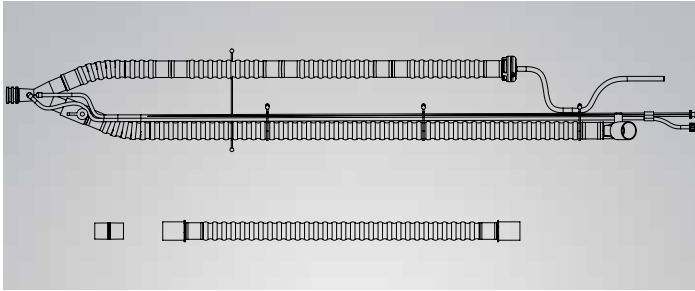

15090-102

Patient circuit w/o PEEP, 22 mm SPU single heated wire, Fisher & Paykel (10/pkg)

1.7 m x 22 mm heated insp limb, temp probe port, wye and 61 cm x 22 mm exp limb

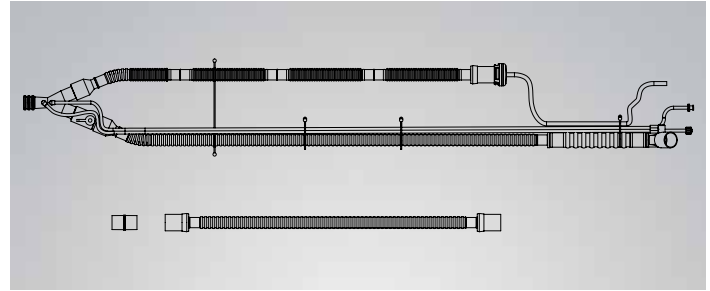

15090-104

Patient circuit w/o PEEP, 15 mm SPU single heated wire, Fisher & Paykel (10/pkg)

1.7 m x 15 mm heated insp limb, temp probe port, wye and 61 cm x 15 mm exp limb

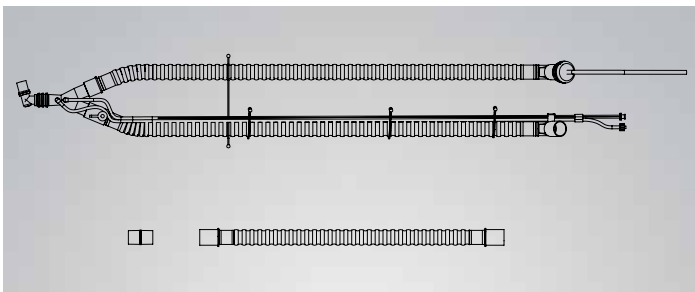

15091-102

Patient circuit w/o PEEP w/elbow, 22 mm SPU dual heated wire, Fisher & Paykel (10/pkg)

1.7 m x 22 mm heated insp limb, temp probe port, wye, elbow and 61 cm x 22 mm heated exp limb

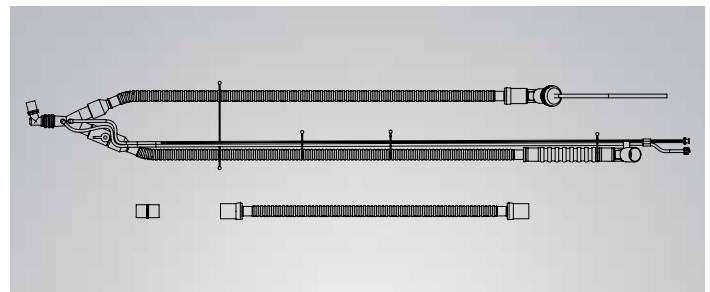

15091-104

Patient circuit w/o PEEP w/elbow, 15 mm SPU dual heated wire, Fisher & Paykel (10/pkg)

1.7 m x 15 mm heated insp limb, temp probe port, wye, elbow and 61 cm x 15 mm heated exp limb

LTV Series circuits

LTV Series 1100, 1150 and 1200 ventilator circuits without PEEP (continued)

SPU heated wire circuits for Teleflex humidifiers, 5.5 ft

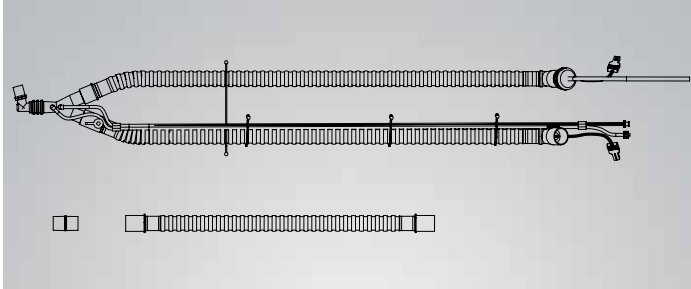

18855-001

Patient circuit w/o PEEP w/elbow, 22 mm SPU dual heated wire, Teleflex (10/pkg)

1.7 m x 22 mm heated insp limb, temp probe port, wye, elbow and 61 cm x 22 mm heated exp limb

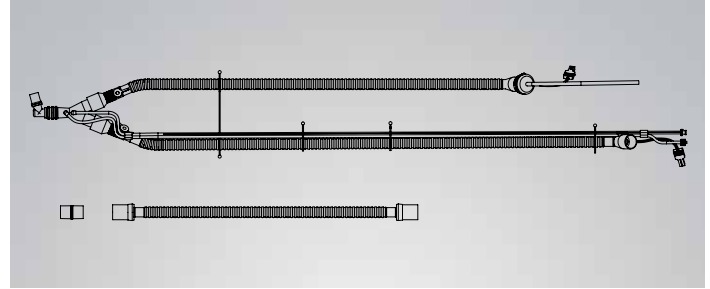

18856-001

Patient circuit w/o PEEP w/elbow, 15 mm SPU dual heated wire, Teleflex (10/pkg)

1.7 m x 15 mm heated insp limb, temp probe port, wye, elbow and 61 cm x 15 mm heated exp limb

SPU MR safe circuit, 15 ft

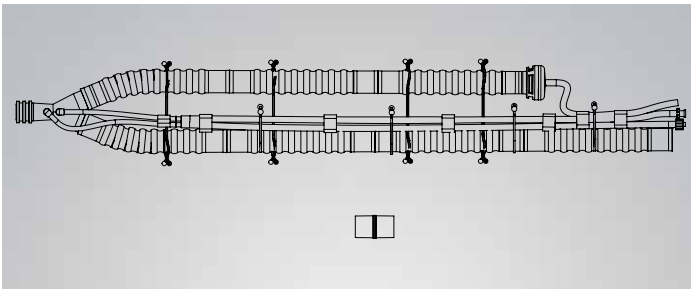

19189-001

Patient circuit w/o PEEP, 22 mm SPU, 15 ft (5/pkg)

LTV Series 900, 950 and 1000 ventilator circuits with PEEP

SPU circuits, 6 ft

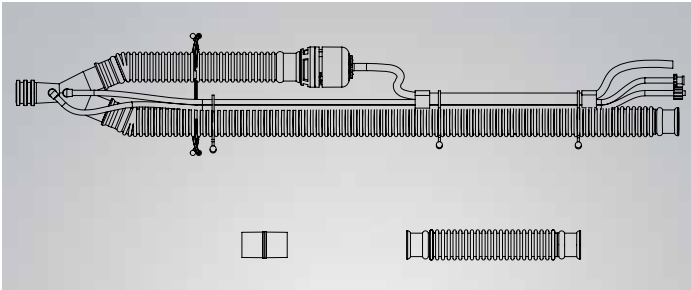

10820x10

Patient circuit w/PEEP, 22 mm SPU (10/pkg)

1.8 m x 22 mm insp limb, wye and 61 cm x 22 mm exp limb

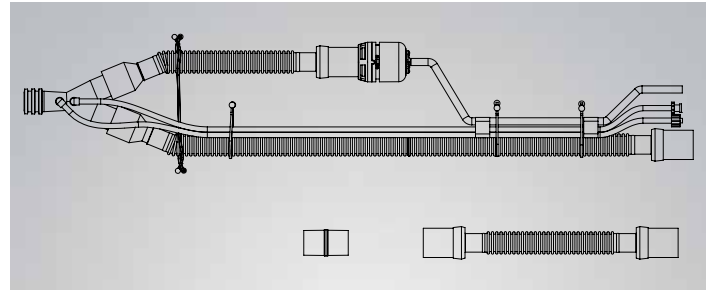

10821x10

Patient circuit w/PEEP, 15 mm SPU (10/pkg)

1.8 m x 15 mm insp limb, wye and 61 cm x 15 mm exp limb

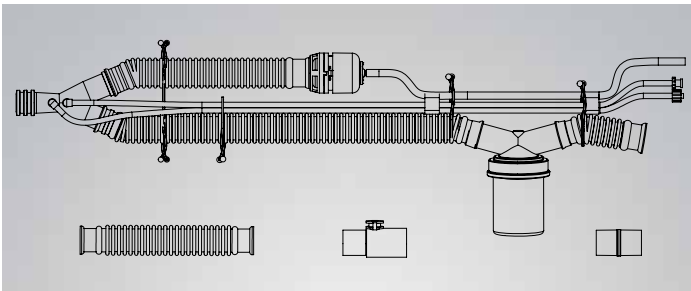

11558x10

Patient circuit w/PEEP w/1 water trap, 22 mm SPU (10/pkg)

1.8 m x 22 mm insp limb w/water trap, temp probe port, wye and 61 cm x 22 mm exp limb

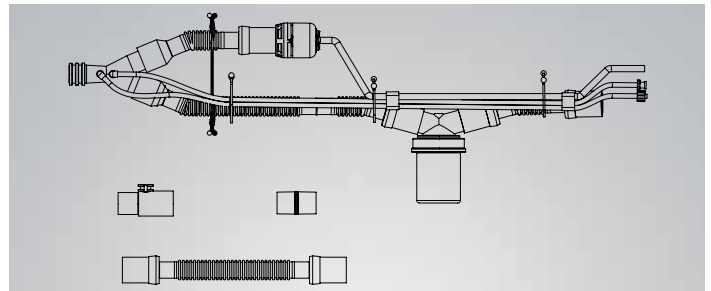

11505x10

Patient circuit w/PEEP w/1 water trap, 15 mm SPU (10/pkg)

1.8 m x 15 mm insp limb w/water trap, temp probe port, wye and 61 cm x 15 mm exp limb

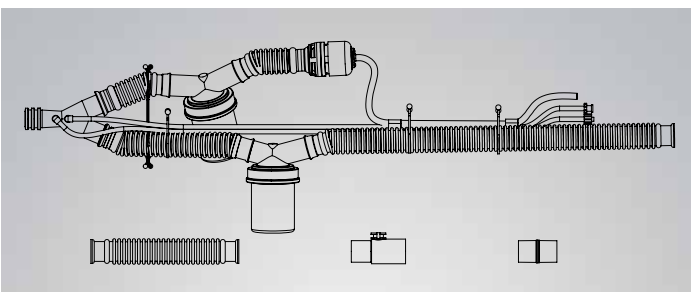

11981x10

Patient circuit w/PEEP w/2 water trap, 22 mm SPU (10/pkg)

1.8 m x 22 mm insp limb w/water trap, temp probe port, wye and 61 cm x 22 mm exp limb w/water trap

LTV Series circuits

LTV Series 900, 950 and 1000 ventilator circuits with PEEP (continued)

SPU circuits, 6 ft

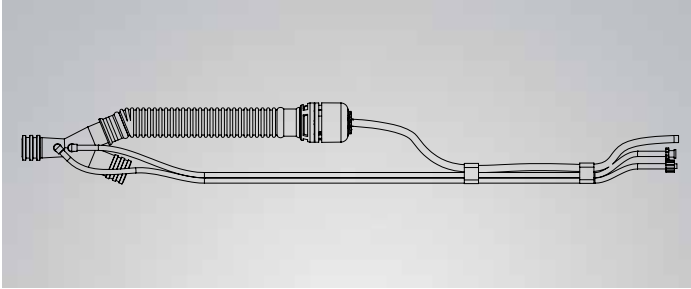

10818x10

Wye and expiratory limb w/PEEP, 22 mm SPU, 6 ft (10/pkg)

Wye and 61 cm x 22 mm exp limb

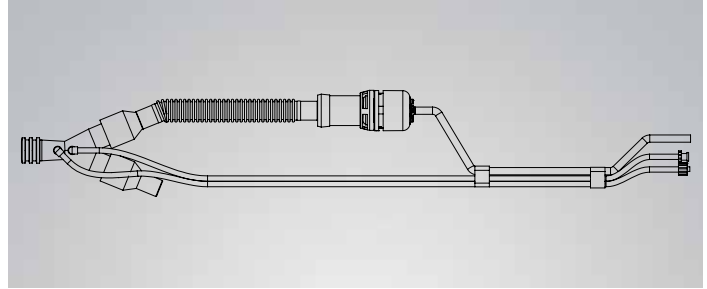

10877x10

Wye and expiratory limb w/PEEP, 15 mm SPU, 6 ft (10/pkg)

Wye and 61 cm x 15 mm exp limb

SPU circuits, 12 ft

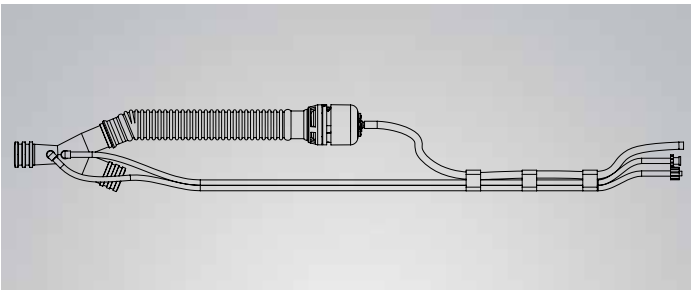

10938x10

Wye and expiratory limb w/PEEP, 22 mm SPU, 12 ft (10/pkg)

Wye and 61 cm x 22 mm exp limb

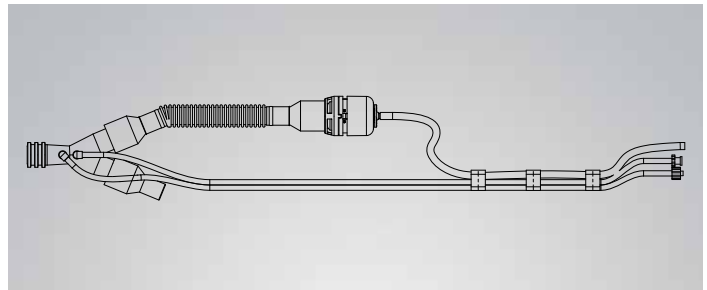

10940x10

Wye and expiratory limb w/PEEP, 15 mm SPU, 12 ft (10/pkg)

Wye and 61 cm x 15 mm exp limb

LTV Series 900, 950 and 1000 ventilator circuits with PEEP (continued)

SPU heated wire circuits for Fisher & Paykel humidifiers, 5.5 ft

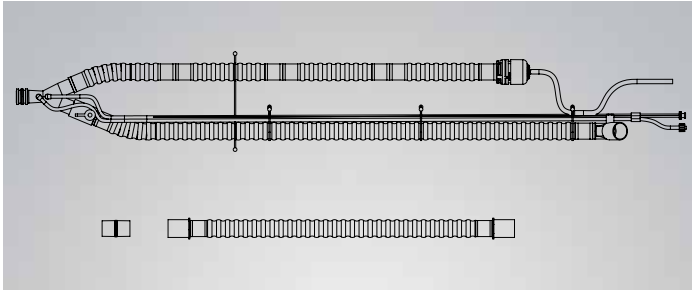

15090-101
Patient circuit w/PEEP, 22 mm SPU single heated wire, Fisher & Paykel (10/pkg)

1.7 m x 22 mm heated insp limb, temp probe port, wye and 61 cm x 22 mm exp limb

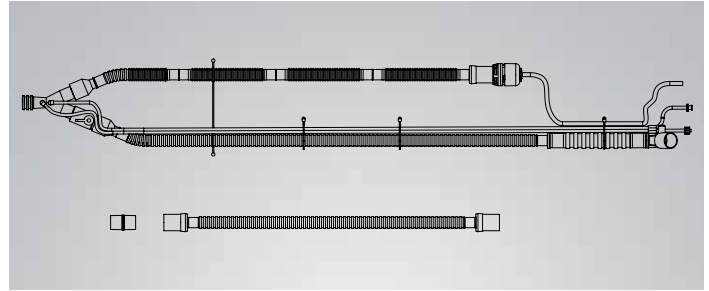

15090-103
Patient circuit w/PEEP, 15 mm SPU single heated wire, Fisher & Paykel (10/pkg)

1.7 m x 15 mm heated insp limb, temp probe port, wye and 61 cm x 15 mm exp limb

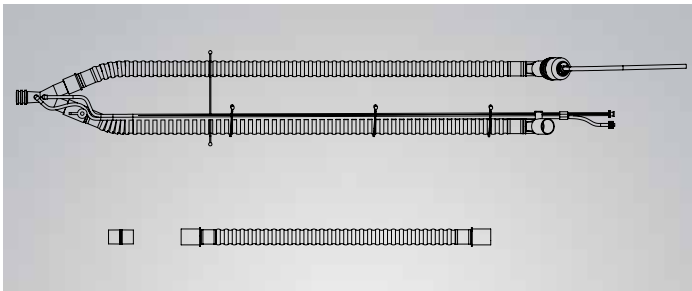

15091-101
Patient circuit w/PEEP, 22 mm SPU dual heated wire, Fisher & Paykel (10/pkg)

1.7 m x 22 mm heated insp limb, temp probe port, wye and 61 cm x 22 mm heated exp limb

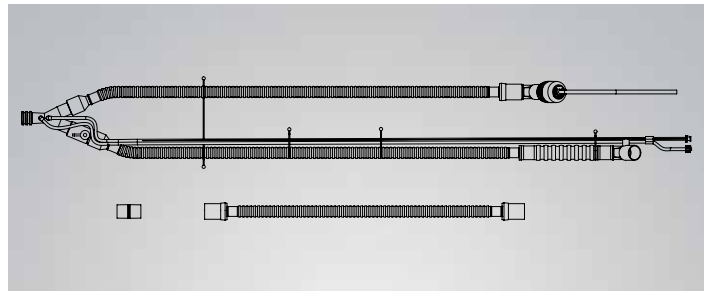

15091-103
Patient circuit w/PEEP, 15 mm SPU dual heated wire, Fisher & Paykel (10/pkg)

1.7 m x 15 mm heated insp limb, temp probe port, wye and 61 cm x 15 mm heated exp limb

SPU heated wire circuits for Teleflex humidifiers, 5.5 ft

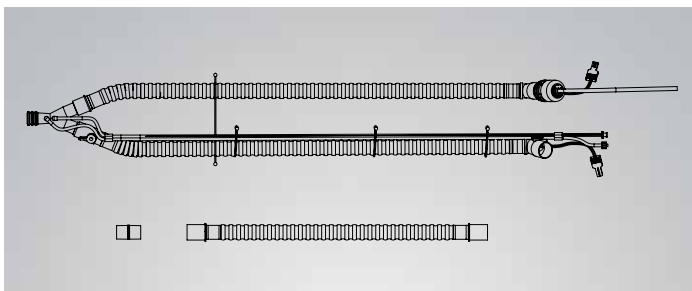

18851-001
Patient circuit w/PEEP, 22 mm SPU dual heated wire, Teleflex (10/pkg)

1.7 m x 22 mm heated insp limb, temp probe port, wye and 61 cm x 22 mm heated exp limb

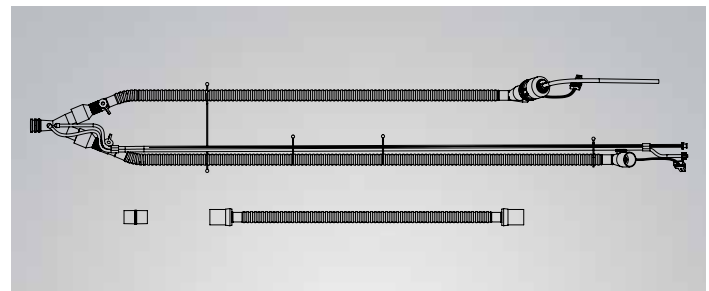

18852-001
Patient circuit w/PEEP, 15 mm SPU dual heated wire, Teleflex (10/pkg)

1.7 m x 15 mm heated insp limb, temp probe port, wye and 61 cm x 15 mm heated exp limb

LTV Series circuits

LTV Series 900, 950 and 1000 ventilator circuits with PEEP (continued)

Reusable circuits, 6 ft

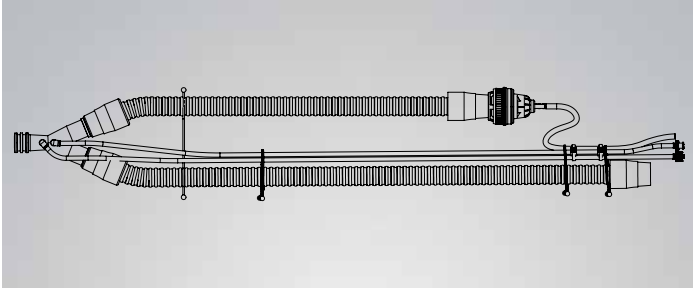

17826-001

Patient circuit w/PEEP, 22 mm reusable (ea)

1.8 m x 22 mm insp limb, wye and 61 cm x 22 mm exp limb

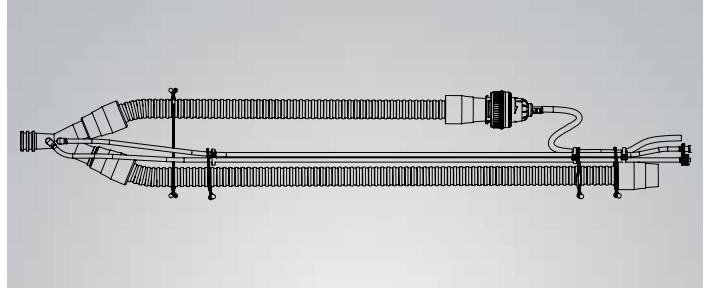

18714-001

Patient circuit w/PEEP, 15 mm reusable (ea) (replaces 10671)

1.8 m x 15 mm insp limb, wye and 61 cm x 15 mm exp limb

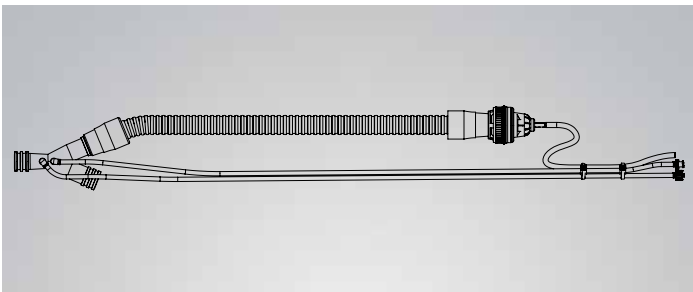

17920-001

Wye and expiratory limb w/PEEP, 22 mm reusable, 6 ft (ea)

Wye and 61 cm x 22 mm exp limb

Reusable circuits, 12 ft

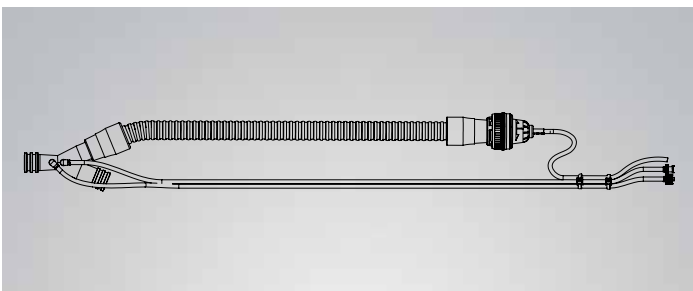

14653-001

Wye and expiratory limb w/PEEP, 22 mm reusable, 12 ft (ea)
(replaces 10937)

Wye and 61 cm x 22 mm exp limb

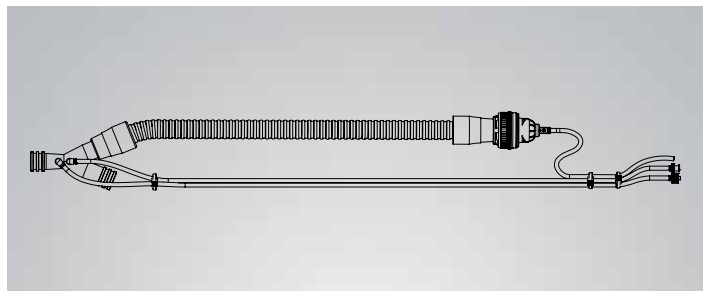

14654-001

Wye and expiratory limb w/PEEP, 15 mm reusable, 12 ft (ea)
(replaces 10939)

Wye and 61 cm x 15 mm exp limb

LTV Series 800 ventilator circuits with PEEP and without flow sensor (for pressure triggering)

SPU circuits, 6 ft

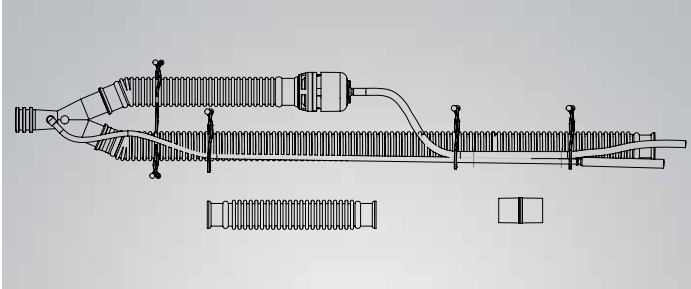

11832x10

Patient circuit w/PEEP, 22 mm SPU (10/pkg)

1.8 m x 22 mm insp limb, wye and 61 cm x 22 mm exp limb

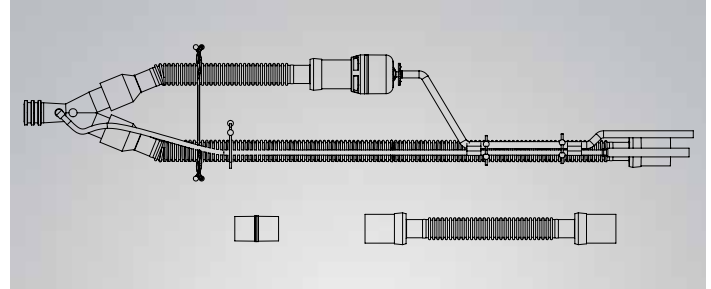

11872x10

Patient circuit w/PEEP, 15 mm SPU (10/pkg)

1.8 m x 15 mm insp limb, wye and 61 cm x 15 mm exp limb

Reusable circuits, 6 ft

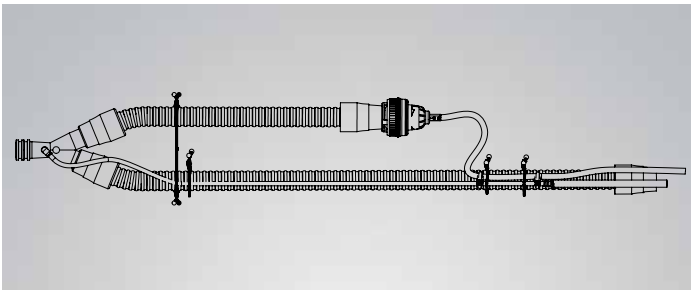

14657-001

Patient circuit w/PEEP, 22 mm reusable (ea) (replaces 11830)

1.8 m x 22 mm insp limb, wye and 61 cm x 22 mm exp limb

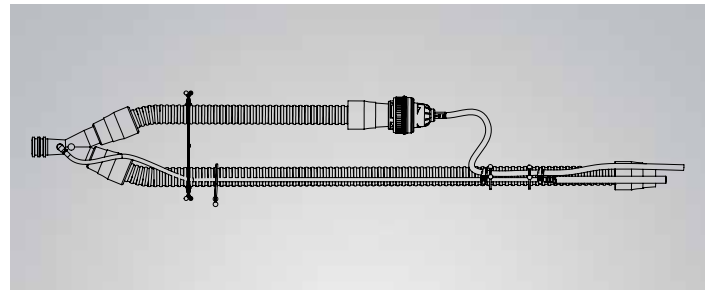

14658-001

Patient circuit w/PEEP, 15 mm reusable (ea) (replaces 11870)

1.8 m x 15 mm insp limb, wye and 61 cm x 15 mm exp limb

Wye and exhalation valves and heated wires

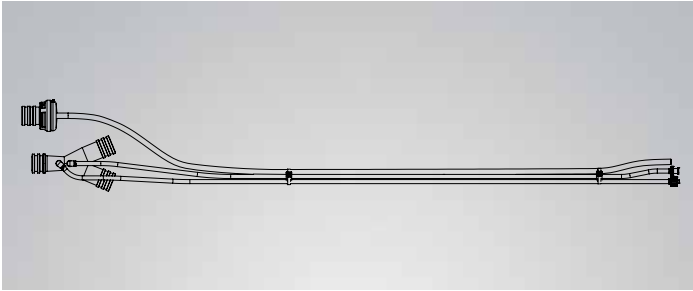

14656-001
Wye and exhalation valve w/o PEEP, reusable (ea) (replaces 10988)

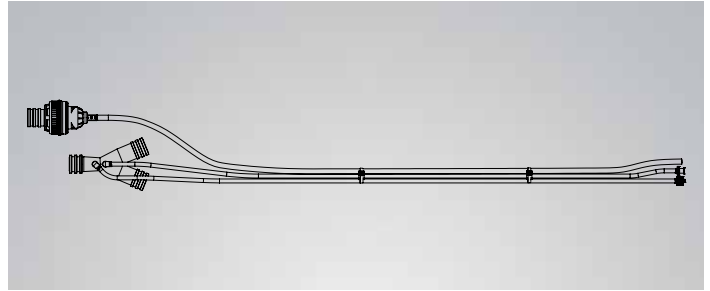

14655-001
Wye and exhalation valve w/PEEP, reusable (ea) (replaces 10987)

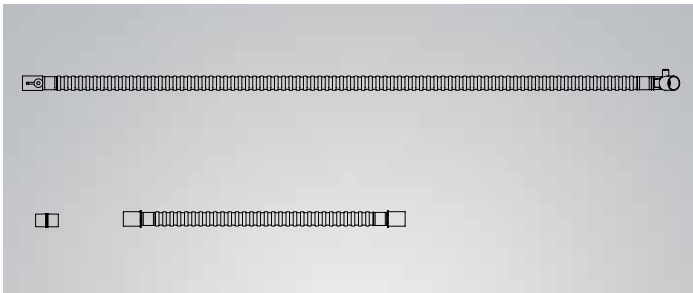

15092-102
Insp limb, 22 mm SPU heated wire, Fisher & Paykel, 5.5 ft (10/pkg)
1.7 m x 22 mm heated insp limb and temperature probe port

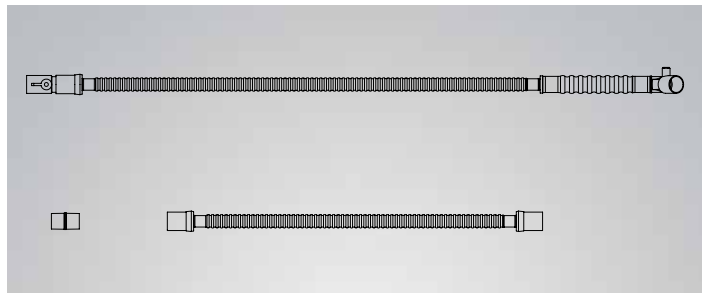

15092-101
Insp limb, 15 mm SPU heated wire, Fisher & Paykel, 5.5 ft (10/pkg)
1.7 m x 15 mm heated insp limb and temperature probe port



10693
Tubing, 22 mm reusable patient, 24 in



10694
Tubing, 15 mm reusable patient, 24 in



10696
Adapter, circuit



10960
Water trap accessory kit, 22 mm reusable

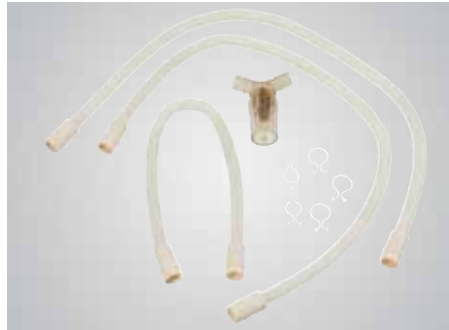

10961
Water trap accessory kit, 15 mm reusable



10113x5
Spring, exhalation valve (5/pkg) (for use in exhalation valves w/PEEP)



17921-001
Exhalation valve w/PEEP, reusable (replaces 10824)



18172-001
Exhalation valve w/o PEEP, reusable (replaces 10825)



17486-101
Diaphragm, exhalation valve (for 17921-001 and 18172-001)

LTV Series power accessories and batteries

SprintPack™ Lithium-Ion Power System



19222-001
Power system, SprintPack lithium-ion
SprintPack power manager, 2 SprintPack batteries and operator manual



19333-001
Power manager, SprintPack



19444-001
Battery, SprintPack



19096-001
Bracket, SprintPack mounting



19102-001
Transport pack for LTV and SprintPack
5 D-rings, detachable shoulder strap, hand strap and bedrail mount



11544
Cord, automotive power, 12 ft



19871-001
Mounting bracket, MR Conditional SprintPack

External sealed lead-acid batteries



10800
Battery kit, 9-hour external
12 V/33 amp-hour battery, battery box w/strap, charger, battery cable and operator manual



10787
Battery, 9-hour external (12 V/33 amp-hour)



10790
Battery box w/strap, external



10900
Battery kit, 9-hour external
12 V/12 amp-hour battery, padded battery bag w/cable, charger, battery cable and operator manual



11475
Battery, 3-hour external (12 V/12 amp-hour)



10901
Cable, 3-hour external battery



11330
Bag with cable, padded battery
(for use w/3-hour battery)



10802
Cable, DC external battery
(for use w/3-hour and 9-hour battery)



10801
Charger, external battery
(for use w/3-hour and 9-hour battery)

LTV Series power accessories and batteries

Universal power supply (UPS)



14546-001

Universal power supply

Hospital-grade AC power cord, battery charger w/power meter, DC power cord and operator manual

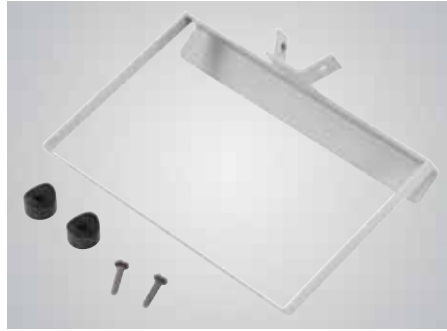

15009-001

Bracket, universal power supply mounting



17894-001

Battery, universal power supply

Miscellaneous power accessories



11448

AC power adapter w/power cord, LTV



17527-001

AC power adapter w/o power cord, LTV



10854

Fuse, 32 V, 10 amp battery



11456

Electrical strip w/4 m power cord, 4-outlet U.S. hospital grade



11544

Cord, automotive power, 12 ft



10536

Power cord, 110 VAC hospital grade, 10 ft

LTV Series stands



10611
Stand w/oxygen cylinder ring, LTV Series floor



10695
Stand, LTV Series table

LTV Series ventilator stands, packs and mounting accessories

LTV Series mounts, packs and carries



10700
Mount, bedrail



11581-G
Backpack for LTV Series ventilators with
boots (gray)



19102-001
Transport pack for LTV Series ventilators and
SprintPack
5 D-rings, detachable shoulder strap, hand
strap and bedrail mount



19184-001
Freedom carrier, LTV Series ventilators and
SprintPack

LTV Series mounting accessories



10610
Bracket, female dove-tail



10979
Bracket, humidifier pole mount C-clamp

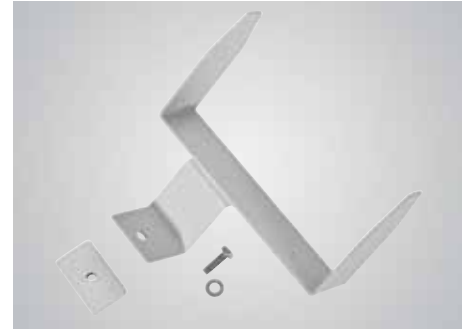

11454
Bracket, large battery mounting

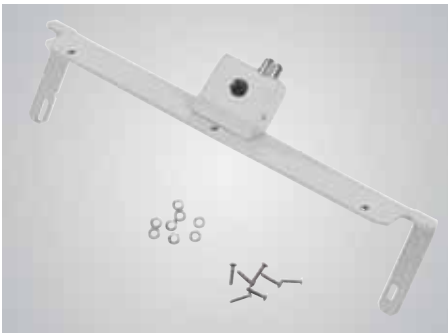

17916-001
Bracket, LTM Graphics Monitor mounting



19096-001
Bracket, SprintPack mounting



15009-001
Bracket, UPS mounting



10658
Hand strap, LTV Series ventilators
(gray)



19031-001
Hand strap, LTV Series ventilators
(purple)

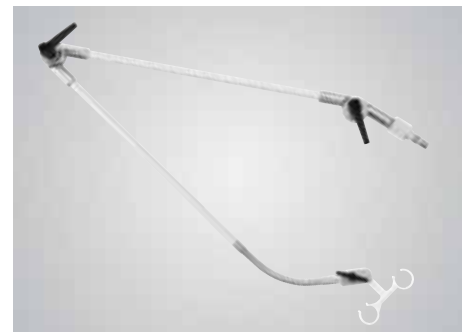

11501
Support arm w/circuit hanger, patient circuit

LTV Series stands, packs and mounting accessories

LTV Series mounting accessories (continued)

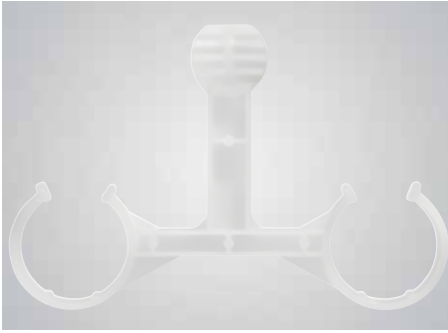

11503
Hanger, clip, circuit support arm

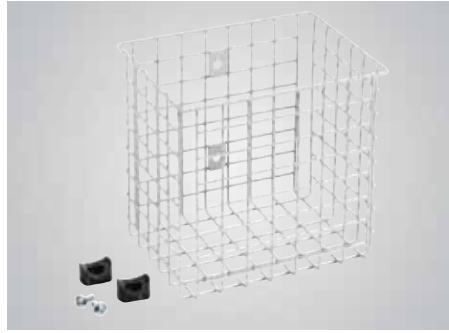

11450
Basket, utility



11451
Crossbar, short



11452
Crossbar, long



11453
Pole, humidifer



11455
Oxygen cylinder ring set
(for use w/10611)



17341-001
Strap, transport pack shoulder

LTV Series mounting accessories sold but not shown

Cat. No.	Description
CAS-1152	Caster for floor stand (for use w/10611)
CAS-1168	Caster for floor stand, locking (for use w/10611)

LTV Series mounting accessories (continued)



19870-001
L-bracket w/screws for LTV Series MR Conditional floor stand



19871-001
Mounting bracket, LTV Series MR Conditional SprintPack



19873-001
Caster for LTV Series MR Conditional floor stand



19874-001
Caster for LTV Series MR Conditional floor stand, locking



19875-001
Oxygen cylinder ring set, LTV Series MR Conditional floor stand

LTV Series miscellaneous parts & accessories



11553
Alarm, remote



34910
Cable, remote alarm, 50 ft
(for use w/alarm 11553)



19103-001
Cable, remote alarm, BNC - phone, 20 ft



14647-001
Cable, nurse call splitter

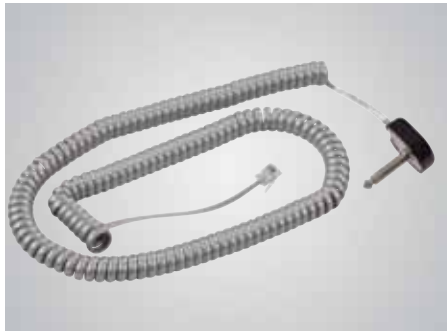

10779
Cable, nurse call, normally closed



10780
Cable, nurse call, normally open



17986-001
Adapter, electrical, Fisher & Paykel 900 MR
900 dual heated limb



17987-001
Adapter, electrical, Fisher & Paykel 900 MR
901 single heated limb



10701
Adapter, low pressure oxygen

LTV Series miscellaneous parts & accessories

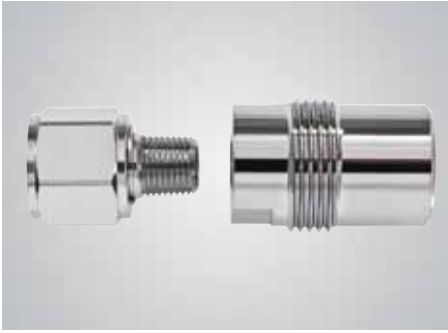

10702
Adapter, NIST oxygen



11550
Boot kit
(gray protective)



19175-001
Boot kit
(purple protective)



15016-001
Cap, blender



14446
Cap, tethered port
(for use w/LTV Series 800, 900, 950, 1100
and 1150 ventilators)



18098-001
Card, compact flash

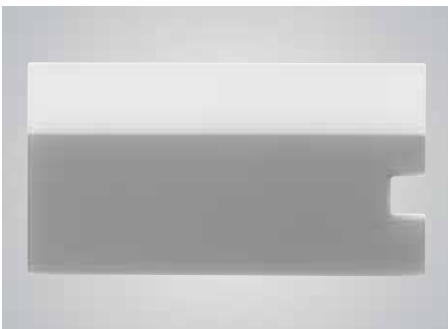

10109
Cover, front panel dust



11456
Electrical strip w/4 m power cord, 4-outlet
U.S. hospital grade



10678
Fan grill assembly
Fan grill, fan grill enclosure, fan filter

LTV Series ventilator miscellaneous parts & accessories

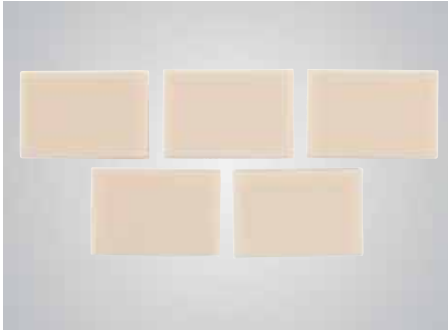

10258x5
Filter, LTV Series air inlet (5/pkg)



10789x5
Filter, LTV Series fan (5/pkg)



10699
Hose, 15 ft oxygen
(green)



11466
Test lung, 1L

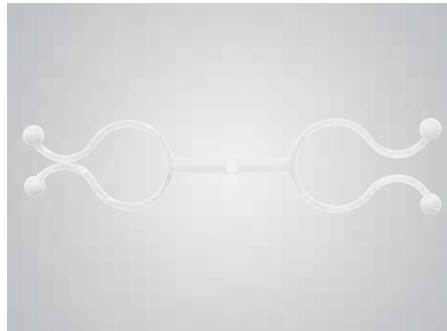

10934x50
Tie, circuit twist-loc, dual (50/pkg)

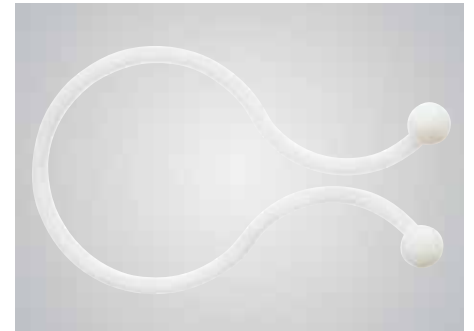

10936x50
Tie, circuit twist-loc, large (50/pkg)



Cat. No.	Size	Qty.
RT041S	Full face NIV mask, small	(1/ea)
RT041M	Full face NIV mask, medium	(1/ea)
RT041L	Full face NIV mask, large	(1/ea)



LTV Series ventilator shipping carton

Cat. No.	Desc
19818-001	Carton, shipping (replaces 17496-001)
17490-001	Sheet, divider (secures AC adapter)
17489-001	Sheet, divider (secures operator manual)
17487-001	Cap set, LTV end

Order all four parts

LTV Series manuals & educational materials

Cat. No.	Desc
19802-001	Operator's Manual, LTV 1200/1150 English
19822-001	Quick Reference Guide, LTV 1200/1150 English
18999-001	In-Service DVD, LTV 1200 English
19990-001	Caregiver Training DVD, LTV 1150 English
19960-001	Emergency Set-Up DVD, LTV 1200 English
21106-001	Operator's Manual, LTV 1100 English
19795-001	Operator's Manual, LTV 1000/950/900 English
19819-001	Quick Reference Guide, LTV 1000/950/900 English
18581-001	In-Service CD/DVD, LTV 1000/950/900 English
18580-001	Caregiver Training DVD, LTV 1000/950/900 English
11600	Simulator CD, LTV 1000 English
17622-001	Recommended Settings Card, LTV 1000/950/900 English (25/pkg)
19797-001	Operator's Manual, LTV 800 English
19821-001	Quick Reference Guide, LTV 800 English
11524	Quick Reference Guide, HME/Hospital English
17754-001	Operator's Manual, LTM II Graphics Monitor English
11009	LTM Graphics Monitor CD, English
21188-001	Operator's Manual, LTV 1200/1150 Spanish
21196-001	Quick Reference Guide, LTV 1200/1150 Spanish
19799-001	Operator's Manual, LTV 1000/950/900 Spanish
19820-001	Quick Reference Guide, LTV 1000/950/900 Spanish

PTV Series EnVe[®] ventilator





004-13914-001
PTV™ stand O₂ cylinder basket holder



004-12140-001
PTV patient circuit support arm



004-13885-001
PTV wall mount (*gray*)
Circuit support arm not included



004-13887-001
PTV wall mount circuit support arm
For use with gray wall mount (004-13885-001)



004-13886-001
PTV wall mount humidifier pole



004-18862-001
PTV wall mount (*purple*)
Circuit support arm kit (PN 004-13885-001) included



004-19937-001
PTV mounting base
For use with docking station
(PN 004-19270-001)



004-19574-001
PTV desktop mounting stand



004-12103-001
PTV AC adapter power kit
AC adapter and power cord included

EnVe ventilator accessories



004-13955-001
PTV desktop battery charger
with 110 VAC power cord
(batteries not included)



004-13908-001
PTV lithium-ion
Hot-swappable battery
Each



004-19495-001
PTV protective collar, replacement kit



004-19833-001
PTV fan filter
Pack of 10



004-13063-001
PTV VOXP data adapter and cable



004-19826-001
PTV air inlet filter
Each



004-12695-002
PTV carry case



004-12102-001
PTV automobile charger
Each



004-18602-001
SpO₂ module
Cable only, each



004-19461-001
SpO₂ clip sensor, pediatric
Reusable, each



004-13035-001
SpO₂ clip sensor, adult
Reusable, each



004-19462-001
SpO₂ reflectance sensor
Each



004-13897-001
PTV cable, FiO₂
Each



004-13036-001
FiO₂ sensor
Each



004-13037-001
FiO₂ sensor T piece
Reusable, each



004-13038-001
FiO₂ sensor T piece
Single patient use, box of 10

Ventilator accessories sold but not shown

Cat. No.	Description	Qty.
004-13912-001	PTV roll stand includes circuit support arm (P/N 004-12140-001)	Each
004-19463-001	SpO ₂ Flexi-Form II, adult, single patient use	Box of 10
004-19464-001	SpO ₂ Flexi-Form II, pediatric, single patient use	Box of 10
004-19465-001	SpO ₂ Flexi-Form II, infant, single patient use	Box of 24
004-19827-001	Exhalation diaphragms, kit	Pack of 10
004-19828-001	Expiratory port, kit	Each

EnVe ventilator circuits

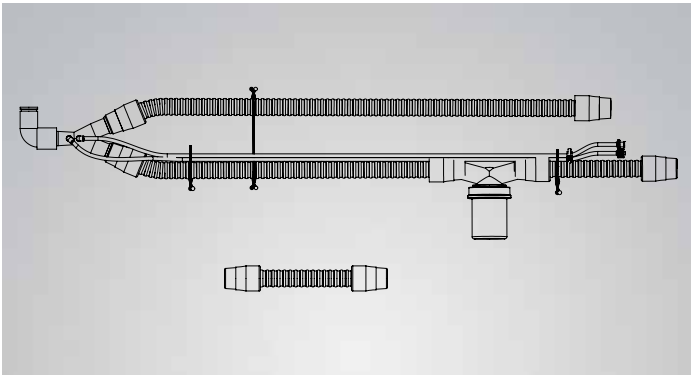

004-18220-001
Patient circuit adult
 Non-heated
 Reusable, each

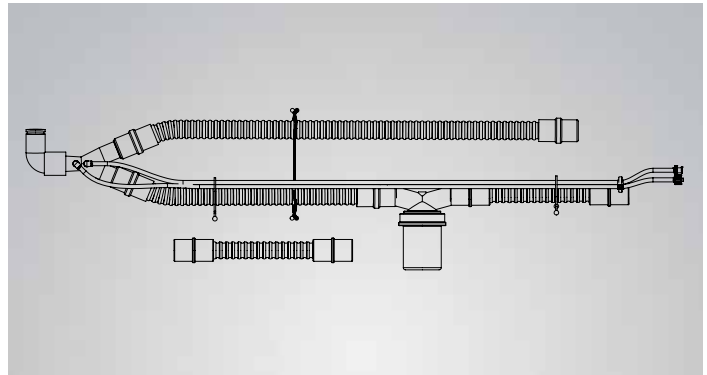

004-18227-001
Patient circuit pediatric
 Non-heated
 Reusable, each

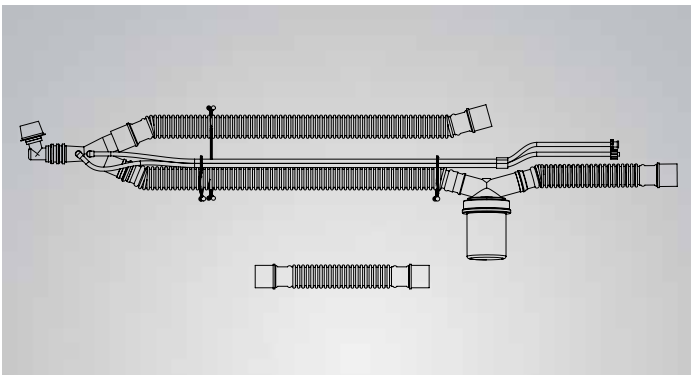

004-18221-101
Patient circuit adult
 Non-heated
 Single patient use, box of 10

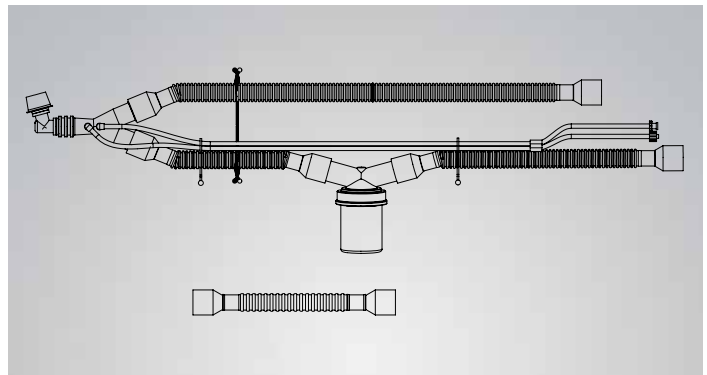

004-18228-101
Patient circuit pediatric
 Non-heated
 Single patient use, box of 10

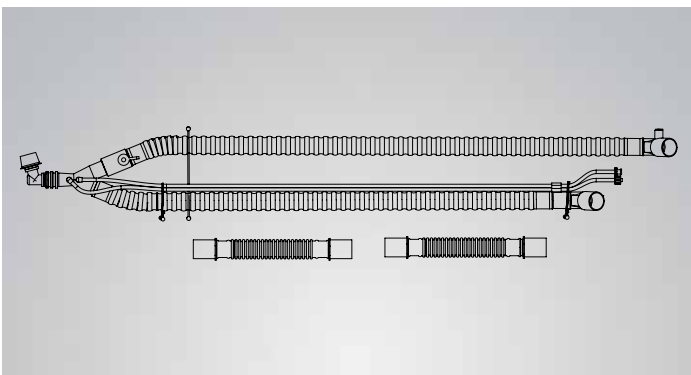

004-18223-101
Fisher & Paykel MR850 humidifier
 Patient circuit adult, dual heated limb
 Single patient use, box of 10

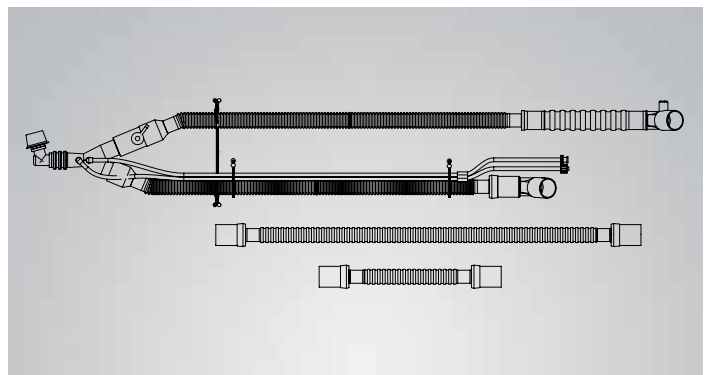

004-18230-101
Fisher & Paykel MR850 humidifier
 Patient circuit pediatric, dual heated limb
 Single patient use, box of 10

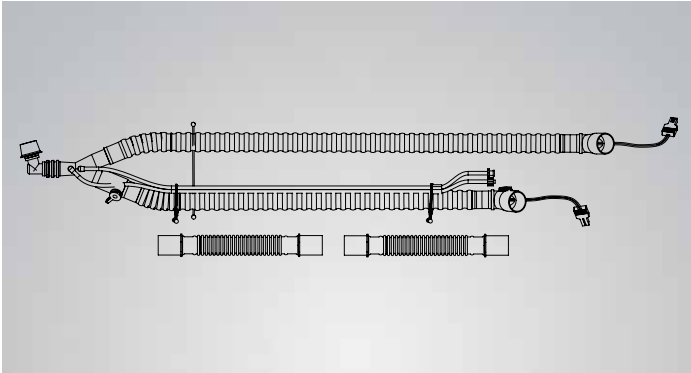

004-19211-001
Teleflex patient circuit adult
Dual heated limb
Single patient use, box of 10

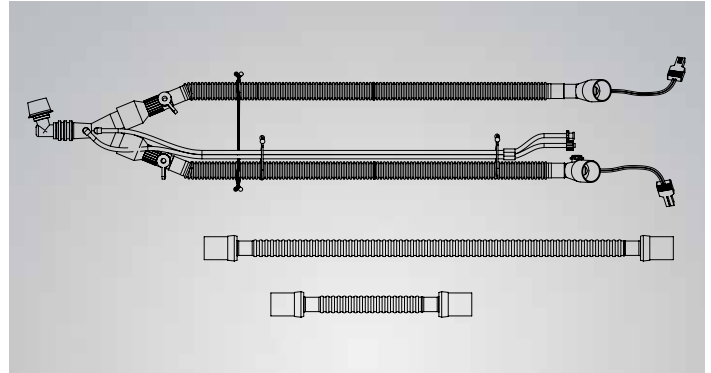

004-19212-001
Teleflex, patient circuit pediatric
Dual heated limb
Single patient use, box of 10

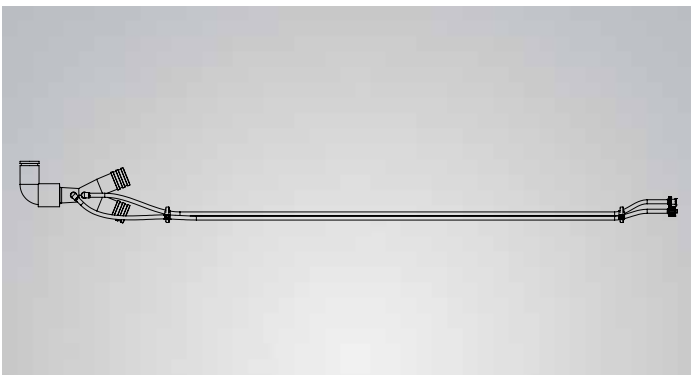

004-18225-001
Patient circuit wye with flow sensor
Reusable, each

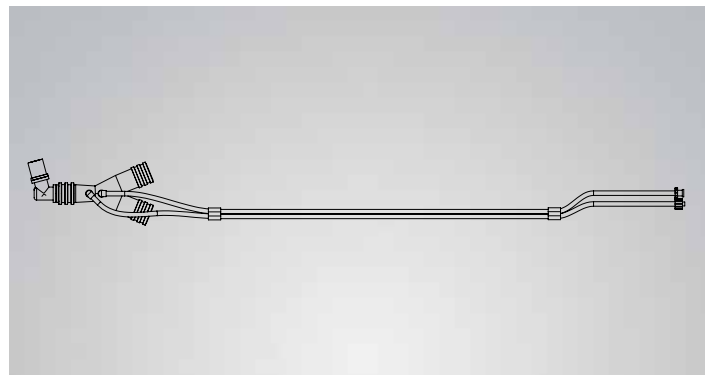

004-18226-101
Patient circuit wye with flow sensor
Single patient use, box of 10

PTV Series ReVel[®] ventilator



ReVel ventilator



19260-001

ReVel ventilator

ReVel ventilator, main battery, power adapter w/power cord, oxygen (O₂) hose, carrying case, O₂ sensor cable, O₂ sensor, O₂ tee and operator manual



99260-001

ReVel system w/floor stand and docking station

ReVel ventilator, main battery, O₂ hose, O₂ sensor cable, O₂ sensor, O₂ tee and operator manual; floor stand, patient circuit support arm, 3/16" hex wrench and instructions; docking station, protective cover, power cord and operator manual

PalmTop Monitor (PTM™) II graphics monitor



19400-001

PTM graphics monitor

PTV docking stations, stands and accessories



19270-001

Docking station

Docking station, protective cover, power cord and operator manual



21380-001

Protective collar, docking station



13914-001

Basket, O₂ cylinder (for use w/floor stand 13912-001)



19574-001

Stand, table



13912-001

Stand, floor, w/patient circuit arm

Floor stand, patient circuit support arm, 3/16" hex wrench and instructions



18862-001

Wall mount w/circuit support arm for docking station

Wall channel, 12" support arm, mounting plate, channel cover, 16" support arm, patient circuit support arm and instructions



13886-001

Wall mount, humidifier pole



12140-001

Arm, patient circuit support

PTV docking stations, stands and accessories (continued)



19937-001
Mounting plate, docking station (for use w/GCX wall mounts)



12695-002
ReVel carry case

PTV power accessories and batteries



12103-001
Power adapter w/power cord, 110 VAC



13955-001
Charger, desktop battery w/110 VAC power cord (batteries not included)



10536
Power cord, 110 VAC, hospital grade, 10'



13908-001
Battery, main lithium-ion



12102-001
Adapter, automobile power point, 12'

PTV miscellaneous parts and accessories



10699
Hose, O₂, 15'



13036-001
Sensor, O₂



13037-001
T-Piece, reusable O₂ sensor



13038-001
T-Piece, SPU O₂ sensor (10/pkg)



13897-001
Cable, O₂ sensor



18602-001
Cable, SpO₂



13035-001
SpO₂ clip sensor, reusable adult



19461-001
SpO₂ clip sensor, reusable pediatric

PTV miscellaneous parts and accessories (continued)



19462-001
SpO₂ reflectance sensor



13063-001
Adapter and cable, VOXP data



19826-001
Filter, air inlet



19833-001
Filter, fan (10/pkg)

Cat. No.	Size	Qty.
19463-001	SpO ₂ Flexi-Form II, SPU adult	10/pkg
19464-001	SpO ₂ Flexi-Form II, SPU pediatric	10/pkg
21311-001	SpO ₂ Flexi-Form III, SPU adult	24/pkg

PTV ReVel circuits

SPU circuits, 6'

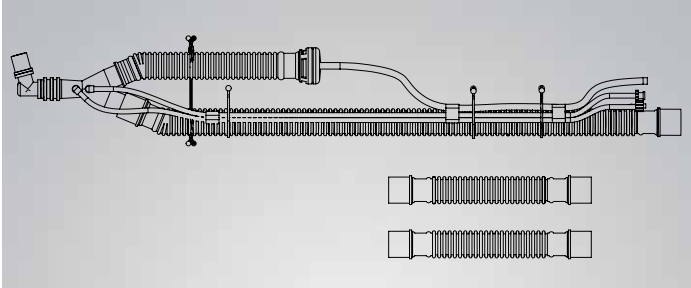

14858-001

Patient circuit w/o PEEP w/elbow, 22mm SPU (10/pkg)

w/1.8 m x 22 mm ID inspiratory limb, wye, elbow and 61 cm x 22 mm expiratory limb

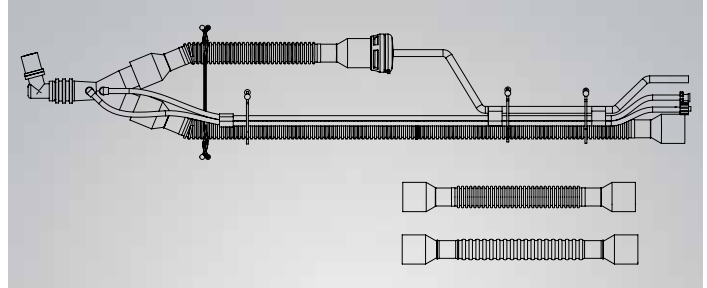

14859-001

Patient circuit w/o PEEP w/elbow, 15mm SPU (10/pkg)

w/1.8 m x 15 mm ID inspiratory limb, wye, elbow and 61 cm x 15 mm expiratory limb

SPU heated wire circuits for Fisher & Paykel (F&P) humidifiers, 5.5'

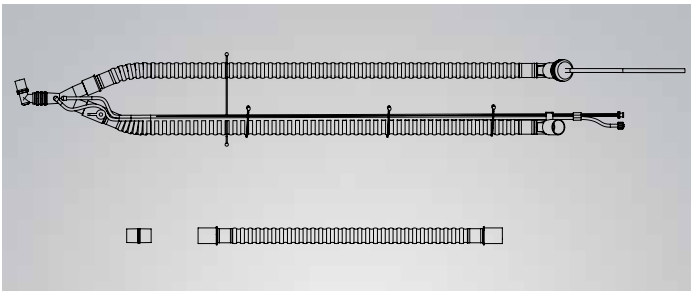

15091-102

Patient circuit w/o PEEP w/elbow, 22 mm SPU dual heated wire, F&P (10/pkg)

w/1.7 m x 22 mm ID heated inspiratory limb, temp probe port, wye, elbow and 61 cm x 22 mm heated expiratory limb

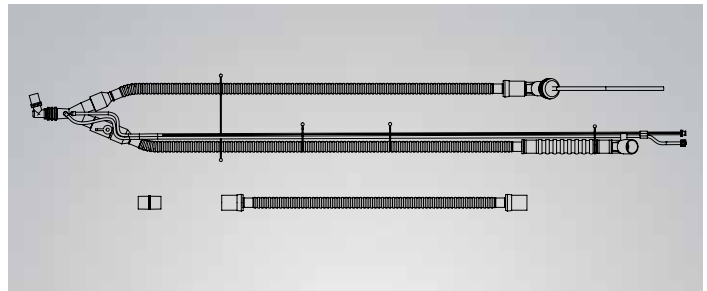

15091-104

Patient circuit w/o PEEP w/elbow, 15 mm SPU dual heated wire, F&P (10/pkg)

w/1.7 m x 15 mm ID heated inspiratory limb, temp probe port, wye, elbow and 61 cm x 15 mm heated expiratory limb

SPU heated wire circuits for ConchaTherm® or Neptune™ humidifiers, 5.5'

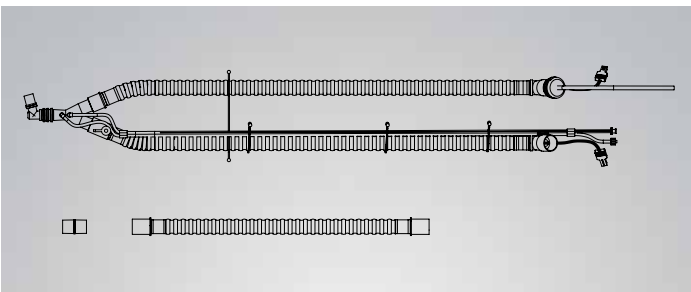

18855-001

Patient circuit w/o PEEP w/elbow, 22 mm SPU dual heated wire, Teleflex (10/pkg)

w/1.7 m x 22 mm ID heated inspiratory limb, temp probe port, wye, elbow and 61 cm x 22 mm heated expiratory limb

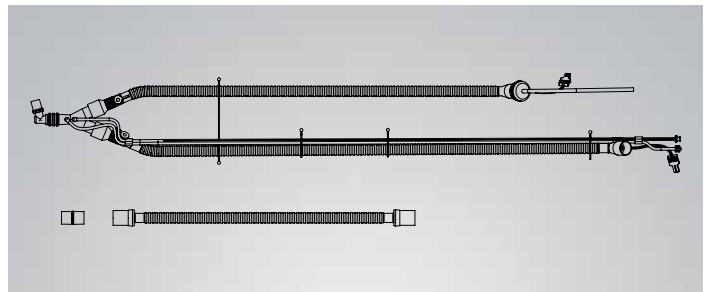

18856-001

Patient circuit w/o PEEP w/elbow, 15 mm SPU dual heated wire, teleflex (10/pkg)

w/1.7 m x 15 mm ID heated inspiratory limb, temp probe port, wye, elbow and 61 cm x 15 mm heated expiratory limb

PTV ReVel circuits (continued)

Reusable patient circuits, 6'

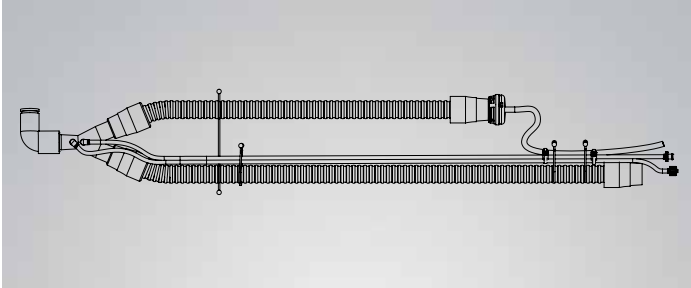

14863-001

Patient circuit w/o PEEP w/elbow, 22 mm reusable (each)

w/1.8 m x 22 mm ID inspiratory limb, wye, elbow and 61 cm x 22 mm expiratory limb

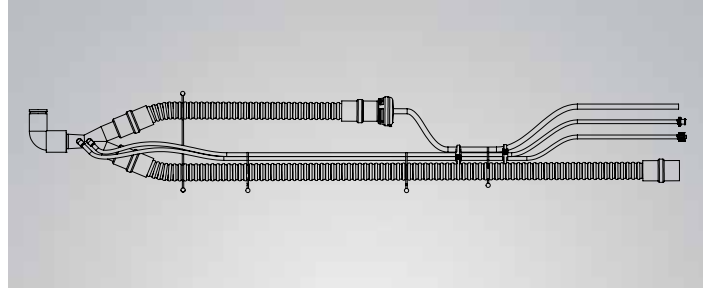

14862-001

Patient circuit w/o PEEP w/elbow, 15 mm reusable (each)

w/1.8 m x 15 mm ID inspiratory limb, wye, elbow and 61 cm x 15 mm expiratory limb

Circuit accessories

Cat. No.	Description	Qty.
18225-001	Patient wye and sense lines, reusable	
18226-101	Patient wye and sense lines, SPU	10/pkg

Terms and Conditions

Minimum order of \$50.00 required

Terms and Conditions of Sale:

Pricing and warranties are subject to change without notice.

Merchandise Return Policy:

1. Please contact our Customer Care Team for a Return Material Authorization (RMA) number prior to returning merchandise
2. Customers may return unopened and unused product within 30 days
3. All Products are subject to a 20% restocking fee
4. Please be prepared with the following information:
Item number, Serial or Lot Number, with Purchase Order or Sales Order Number

To place an order or for more information, please contact Customer Service at:

Phone:

800-754-1914 United States

763-398-8300 International

Fax:

763-398-8359 United States

763-398-8403 International

Email:

pulmoneticare@carefusion.com

LTV Series ventilators

10109	27
10536	20
10610	23
10611	21
10658	23
10678	27
10693	17
10694	17
10695	21
10696	17
10699	28
10700	22
10701	26
10702	27
10779	26
10780	26
10787	19
10790	19
10800	19
10801	19
10802	19
10854	20
10900	19
10901	19
10960	17
10961	17
10979	23
11009	29
11089	5
11330	19
11448	20
11450	24
11451	24
11452	24
11453	24
11454	23
11455	24
11456	20, 27
11466	28
11475	19
11501	23
11503	24
11524	29
11544	18, 20
11550	27
11553	26
11600	29
14446	27
34910	26
10113x5	17
10258x5	28
10789x5	28
10818x10	12
10819x10	7
10820x10	11
10821x10	11
10822x10	6
10823x10	6
10877x10	12
10878x10	7
10934x50	28
10936x50	28
10938x10	12
10940x10	12

11089-002	5
11505x10	11
11558x10	11
11581-G	22
11832x10	15
11872x10	15
11981x10	11
11985x10	6
14546-001	20
14647-001	26
14653-001	14
14654-001	14
14655-001	16
14656-001	16
14657-001	15
14658-001	15
14858-001	7
14859-001	7
14862-001	8
14863-001	8
15009-001	20, 23
15016-001	27
15090-101	13
15090-102	9
15090-103	13
15090-104	9
15091-101	13
15091-102	9
15091-103	13
15091-104	9
15092-101	16
15092-102	16
17341-001	24
17486-101	17
17487-001	28
17489-001	28
17490-001	28
17527-001	20
17622-001	29
17650-001	5
17754-001	29
17826-001	14
17894-001	20
17916-001	5, 23
17920-001	14
17921-001	17
17986-001	26
17987-001	26
17997-001	8
18029-001	8
18093-001	5
18097-001	5
18098-001	5, 27
18172-001	17
18580-001	29
18581-001	29
18714-001	14
18851-001	13
18852-001	13
18855-001	10
18856-001	10
18881-001	4
18884-001	7
18885-001	7
18888-001	4
18929-001	6

18930-001	6
18941-001	8
18984-001	4
18999-001	29
19031-001	23
19096-001	18, 23
19102-001	18, 22
19103-001	26
19175-001	27
19184-001	22
19189-001	10
19222-001	18
19333-001	18
19444-001	18
19795-001	29
19797-001	29
19799-001	29
19802-001	29
19818-001	28
19819-001	29
19820-001	29
19821-001	29
19822-001	29
19870-001	25
19871-001	18, 25
19873-001	25
19874-001	25
19875-001	25
19960-001	29
19990-001	29
21102-001	4
21106-001	29
21188-001	29
21196-001	29
CAS-1152	24
CAS-1168	24
RT041L	28
RT041M	28
RT041S	28

EnVe ventilators

004-12102-001	32
004-12103-001	31
004-12140-001	31
004-12695-002	32
004-13035-001	33
004-13036-001	33
004-13037-001	33
004-13038-001	33
004-13063-001	32
004-13885-001	31
004-13886-001	31
004-13887-001	31
004-13897-001	33
004-13908-001	32
004-13912-001	33
004-13914-001	31
004-13955-001	32
004-18220-001	34
004-18221-101	34
004-18223-101	34
004-18225-001	35
004-18226-101	35
004-18227-001	34
004-18228-101	34

004-18230-101	34
004-18602-001	33
004-18862-001	31
004-19211-001	35
004-19212-001	35
004-19461-001	33
004-19462-001	33
004-19463-001	33
004-19464-001	33
004-19465-001	33
004-19495-001	32
004-19574-001	31
004-19826-001	32
004-19827-001	33
004-19828-001	33
004-19833-001	32
004-19937-001	31

ReVel ventilators

10536	39
10699	40
12102-001	39
12103-001	39
12140-001	38
12695-002	39
13035-001	40
13036-001	40
13037-001	40
13038-001	40
13063-001	41
13886-001	38
13897-001	40
13908-001	39
13912-001	38
13914-001	38
13955-001	39
14858-001	42
14859-001	42
14862-001	43
14863-001	43
15091-102	42
15091-104	42
18225-001	43
18226-101	43
18602-001	40
18855-001	42
18856-001	42
18862-001	38
19260-001	37
19270-001	38
19400-001	37
19461-001	40
19462-001	41
19463-001	41
19464-001	41
19574-001	38
19826-001	41
19937-001	39
21311-001	41
21380-001	38
99260-001	37



CareFusion
Yorba Linda, CA

carefusion.com



CareFusion