



February,
2013

IV sets and accessories catalog

featuring:

MaxPlus® clear needleless connector

SmartSite® needle-free valve

Alaris® products





CareFusion

Key terms

0.2 micron filter

Removes particulate matter larger than 0.2 microns and virtually all fungi and bacteria. Often used as final filter for air elimination in the NICU. Recommended for use with non-lipid TPN infusions. Required for use with Taxol infusions.

Notes:

- CareFusion filters should not be inverted when priming.
- CareFusion 0.2 micron filters contain Supor (Polyethersulfone) membranes which have low protein and drug binding characteristics.

1.2 micron filter

Removes particulate matter larger than 1.2 microns. Used to filter lipids and/or 3 in 1 solutions; Amiodarone; Mannitol; Remicade requires either 1.2 or 0.2 micron filter.

Notes:

- CareFusion filters should not be inverted when priming.
- CareFusion 1.2 micron filters contain Supor (Polyethersulfone) membranes which have low protein and drug binding characteristics.

15 micron filter

Filters particulates >15 micron from solution (i.e., albumin).

10-drop

Spike is designed so that 10 drops equal approximately 1 mL. Used often by Anesthesiologists in the OR.

15-drop

Spike is designed so that 15 drops equal approximately 1 mL.

20-drop

Spike is designed so that 20 drops equal approximately 1 mL.

60-drop

Spike is designed so that 60 drops equal approximately 1 mL. Used often for Pediatric and Neonatal applications.

Check valve

A device which allows flow in only one direction. Commonly used for secondary piggyback drug administration or to protect certain elements of the set from high pressures seen when a syringe injects into the set. Reduces risk of contaminants flowing towards solution bag.

DEHP (Diethyl hexyl Phthalate)

A chemical commonly used in PVC tubing; used to yield clarity and soft pliable tubing.

Hat valve

Also known as duck bill valve, helps to reduce the chance of wet out of the air vent in the drip chamber when used with bottles.



Tubing does not contain DEHP in the fluid path.

Non-DEHP/DEHP-free

Tubing/set does not contain DEHP.

Non-PVC

Tubing either manufactured completely without polyvinyl chloride or which has an inert lining that helps prevent exposure of infused fluids to polyvinyl chloride.

Latex free

Contains no latex. Latex is known to cause hypersensitivity reactions in significant percentages of patients and health care workers.

Low sorbing

PVC free tubing in the fluid path designed to minimize absorption of drugs (for example nitroglycerin) into the matrix of tubing materials. Also prevents leaching (has inert internal surface).

Microbore

Tubing with smaller internal diameter ≤ 0.04 " to minimize the contained volume. Often used in Pediatric and Neonatal areas. Promotes more efficient drug delivery at low flow rates. Some companies will interchange with smallbore or minibore; there is no standardized internal diameter.

Smallbore

Tubing with smaller internal diameter > 0.04 " and < 0.1 " to minimize the contained volume. Some companies use interchangeably with microbore.

Screen blood filter

Special filter designed for blood and blood products to remove debris such as clots.

Micro aggregate filter

Filters are typically in the 20 to 80 micron range for specialty applications.

Note: CareFusion current product offering does not include these filter types.

Key terms

Non-vented

Characteristic of the spike that enters the solution container. Designed for collapsible plastic containers as no air is required to enter the container in order for fluid to flow.*

Vented

Characteristic of the spike that enters the solution container. Designed for containers that do not collapse when emptying (glass or semi-rigid plastic). Vent allows air to enter the container in order to allow fluid to flow.*

**Note:* All sets with drip chambers are vented/non-vented unless otherwise noted.

CareFusion has made every effort to assure the accuracy of the information in this Catalog. Information on products contained within this catalog may change and these changes may alter the information contained in this publication. Any corrections and changes CareFusion is made aware of after the publication date of this Catalog issuance will be completed in subsequent issues.

Contents

Section	Page
01.00 Needleless connectors and needle-free valves	1
02.00 Access devices and accessories	
02.01 Blood collection devices	2
02.02 Accessories	3
03.00 Chemo-Safety System	
03.01 Texium® closed male luer and SmartSite® access devices and accessories	4
03.02 Vial and bag access devices	8
03.03 Secondary administration sets with SmartSite bag access port and Texium closed male luer	10
03.04 Alaris® Pump module administration sets with SmartSite bag access port and Texium closed male luer	11
03.05 Alaris SE pump administration sets with SmartSite bag access port	14
04.00 Specialty extension sets	
04.01 Filters	
04.01.01 MaxPlus® and MaxGuard® connector sets	15
04.01.02 SmartSite valve sets	20
04.01.03 VersaSafe™ split septum sets	22
04.01.04 No port sets	23
04.02 Stopcocks and manifolds	
04.02.01 Stand alone	26
04.02.02 MaxPlus needleless connector and y-site sets	28
04.02.03 SmartSite valve sets	30
04.02.04 Injection site sets	32
04.02.05 No port sets	33
04.03 T-connectors	
04.03.01 MaxPlus needleless connector sets	36
04.03.02 SmartSite valve sets	40
04.03.03 VersaSafe split septum sets	42
04.03.04 Other access sets	43
04.04 Specialty tubing	
04.04.01 Filters and Flow Regulators	44
04.04.02 No port sets	45
04.05 Labeled for use with low pressure power injectors	
04.05.01 MaxPlus and MaxGuard needleless connector sets	46
04.05.02 SmartSite valve sets	55
04.05.03 No port sets	56

Contents

Section	Page
05.00 Extension sets	
05.01 Standard tubing	
05.01.01 MaxPlus and MaxGuard needleless connector sets	57
05.01.02 SmartSite valve sets	60
05.01.03 VersaSafe split septum sets	66
05.01.04 No port sets	67
05.02 Kink resistant tubing	
05.02.01 MaxPlus and MaxGuard needleless connector sets	70
05.03 Minibore/Smallbore tubing	
05.03.01 MaxPlus and MaxGuard needleless connector sets	74
05.03.02 SmartSite valve sets	85
05.03.03 VersaSafe split septum sets	89
05.03.04 No port sets	90
05.04 Microbore tubing	
05.04.01 MaxPlus and MaxGuard needleless connector sets	95
05.04.02 No port sets	97

Contents

Section	Page
06.00 Alaris Pump module	
06.01 Stopcocks and manifolds	
06.01.01 SmartSite valve sets	99
06.01.02 VersaSafe split septum sets	104
06.02 Burettes	
06.02.01 SmartSite valve sets	105
06.02.02 No port sets	110
06.02.03 VersaSafe split septum sets	111
06.03 Low sorbing tubing	
06.03.01 SmartSite valve sets	113
06.03.02 No port sets	118
06.03.03 VersaSafe split septum sets	120
06.04 Filters	
06.04.01 Blood filters	
06.04.01.01 SmartSite valve sets	121
06.04.01.02 No port sets	122
06.04.01.03 VersaSafe split septum sets	123
06.04.02 0.2 micron filters	
06.04.02.01 SmartSite valve sets	124
06.04.02.02 No port sets	129
06.04.02.03 VersaSafe split septum sets	130
06.04.03 1.2 micron filters	
06.04.03.01 SmartSite valve sets	131
06.04.03.02 No port sets	132
06.04.03.03 VersaSafe split septum sets	133
06.04.04 15 micron filters	
06.04.04.01 SmartSite valve sets	134
06.04.04.02 No port sets	135
06.04.04.03 VersaSafe split septum sets	136
06.05 Special applications	
06.05.01 Yellow striped tubing sets	137
06.05.02 Amber tubing sets	138
06.05.03 SmartSite bag access port sets	139
06.05.04 Ball valve sets	141
06.05.05 Syringe adapter sets	144
06.06 Primary administration sets	
06.06.01 SmartSite valve sets	145
06.06.02 No port sets	152
06.06.03 VersaSafe split septum sets	153

Contents

Section	Page
07.00 Alaris Syringe module sets	
07.01 With pressure sensing disc	156
07.02 Without pressure sensing disc	159
08.00 Alaris PCA module sets	160
09.00 Alaris SE pump	
09.01 Burettes	
09.01.01 SmartSite valve sets	163
09.01.02 VersaSafe split septum sets	165
09.02 Low sorbing tubing	
09.02.01 SmartSite valve sets	166
09.02.02 No port sets	167
09.03 Filters	
09.03.01 Blood filters	
09.03.01.01 SmartSite valve sets	168
09.03.01.02 No port sets	169
09.03.01.03 VersaSafe split septum sets	170
09.03.02 0.2 micron filters	
09.03.02.01 SmartSite valve sets	171
09.03.02.02 No port sets	172
09.03.02.03 VersaSafe split septum sets	173
09.03.03 1.2 micron filters	
09.03.03.01 SmartSite valve sets	174
09.03.03.02 VersaSafe split septum sets	175
09.03.04 15 micron filters	
09.03.04.01 No port sets	176
09.04 Special applications	
09.04.01 Yellow striped tubing sets	177
09.04.02 Amber tubing sets	178
09.04.03 SmartSite bag access port sets	179
09.04.04 Syringe adapter sets	180
09.05 Primary administration sets	
09.05.01 SmartSite valve sets	181
09.05.02 No port sets	185
09.05.03 VersaSafe split septum sets	186

Contents

Section		Page
10.00	MedSystem III® infusion pump	
10.01	Burettes	
10.01.01	SmartSite valve sets	189
10.01.02	Standard injection port sets	190
10.02	Low sorbing tubing	
10.02.01	SmartSite valve sets	191
10.02.02	No port sets	192
10.03	Filters	
10.03.01	Blood filters	
10.03.01.01	SmartSite valve sets	193
10.03.01.02	Standard injection port sets	194
10.03.02	0.2 micron filters	
10.03.02.01	SmartSite valve sets	195
10.03.02.02	Standard injection port sets	196
10.04	Primary administration sets	
10.04.01	SmartSite valve sets	197
10.04.02	No port sets	198
10.04.03	Standard injection port sets	200
11.00	Secondary administration sets	
11.01	Filters	
11.01.01	Blood filters no port sets	201
11.01.02	15 micron filters no port sets	202
11.02	Special applications	
11.02.01	SmartSite bag access port sets	203
11.02.02	Bag access transfer sets	204
11.02.03	Syringe adapter sets	205
11.03	Secondary administration sets	206

Contents

Section		Page
12.00	Gravity sets	
12.01	Stopcocks and manifolds	
12.01.01	MaxPlus needleless connectors and y-site sets	209
12.01.02	SmartSite valve sets	211
12.01.03	VersaSafe split septum sets	216
12.02	Burettes	
12.02.01	MaxPlus needleless connector and y-site sets	217
12.02.02	SmartSite valve sets	219
12.02.03	VersaSafe split septum sets	220
12.03	Low sorbing tubing SmartSite valve sets	224
12.04	Filters	
12.04.01	Blood filters	
12.04.01.01	SmartSite valve sets	222
12.04.01.02	No port sets	223
12.04.02	0.2 micron filters	
12.04.02.01	SmartSite valve sets	224
12.04.02.02	MaxPlus needleless connector and y-site sets	225
12.04.02.03	No port sets	226
12.04.03	1.2 micron filters	227
12.04.04	15 micron filters	228
12.05	Special applications	
12.05.01	Ball valve sets	229
12.05.02	Flow regulator sets	231
12.06	Primary administration sets	
12.06.01	MaxPlus needleless connector and y-site sets	234
12.06.02	SmartSite valve sets	237
12.06.03	No port sets	242
12.06.04	VersaSafe split septum sets	243

01.00 Needleless connectors and needle-free valves





Needleless connectors and needle-free valves eliminate the need for needles, caps, blunt cannulas and add-on components. All devices are latex and DEHP free.

Model #	Drops	Description	Case quantity
MP1000-C		 <p>MaxPlus clear needleless connector Approximate priming volume: 0.28 mL Labeled for use with low pressure power injectors up to 325 psi and maximum flow rate of 10 mL/second.</p>	 100
MP1000A		 <p>MaxGuard antimicrobial needleless connector Approximate priming volume: 0.28 mL Labeled for use with low pressure power injectors up to 325 psi and maximum flow rate of 10 mL/second.</p>	 100
MP1000		 <p>MaxPlus needleless connector Approximate priming volume: 0.28 mL Labeled for use with low pressure power injectors up to 325 psi and maximum flow rate of 10 mL/second.</p>	 100
2000E		 <p>SmartSite needle-free valve Approximate priming volume: 0.11 mL Labeled for use with low pressure power injectors up to 325 psi and maximum flow rate of 10 mL/second.</p>	 100
20558E		 <p>SmartSite tri-port connector Approximate priming volume: 0.46 mL</p>	 50
MX1002		 <p>Standard needleless connector</p>	 100

02.00 Access devices and accessories

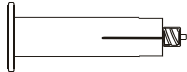
02.01 Blood collection devices

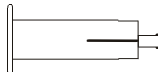







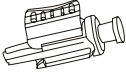

Access devices and accessories provide flexibility and additional infusion capabilities to gravity and infusion instrument sets. All devices are latex and DEHP free. Blood collection devices assist healthcare facilities comply with OSHA directives.

Model #	Drops	Description		Case quantity
MBC6000		 Blood collection assembly, male luer lock		200
MBC6008		 Blood transfer assembly, female luer lock		200

02.00 Access devices and accessories

02.02 Accessories











Access devices and accessories provide flexibility and additional infusion capabilities to gravity and infusion instrument sets. All access devices on this page are latex and DEHP free.

Model #	Drops	Description		Case quantity
9391-0200		VersaSafe™ split septum plastic cannula,-11 gauge		200
70200		Female cap		600
70804		Female/male cap		600
MPC-1A		Breather cap for male luer slips, locks, spin locks		100
MY0240		Pre slit injection port with male luer lock connector		100

03.00 Chemo-Safety System

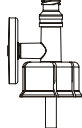
03.01 Texium closed male luer and SmartSite access devices and accessories

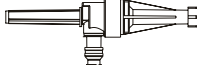









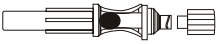

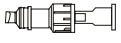
The Texium closed male luer partners with SmartSite needle-free valve to deliver an easy-to-use closed system. The SmartSite IV sets and accessories eliminate the need for needles, caps, blunt cannulas and add-on components. Access devices and accessories provide flexibility and additional infusion capabilities to gravity and infusion instruments sets. All access devices are latex and DEHP free.

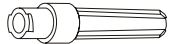
Model #	Drops	Description	Case quantity
10012240-0500		 <p>Texium female cap</p>	 100
10012241-0500		 <p>Texium closed male luer with female cap Approximate priming volume: 0.12 mL</p>	 100
MV0400		 <p>Chemo-Safety Universal Vented Vial Access Device, 0.2 micron hydrophobic air-venting filter, with SmartSite needle-free valve, compatible with 13 mm, 20 mm and 28 mm vial closures. Approximate flow rate > 3000 mL per hour, residual fluid < 1.2 mL Approximate priming volume: < 0.15 mL</p>	 400
10012392-0500		 <p>SmartSite 20mm vented vial access device, 0.2 micron hydrophobic air-venting filter Approximate priming volume: 0.14 mL</p>	 80
10013365		 <p>SmartSite add-on bag access device, spike adapter, with 1 needle-free valve bag access port Approximate length: 3.8" 9.6 cm. approx. Approximate priming volume: 0.61 mL</p>	 100

03.00 Chemo-Safety System

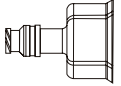
03.01 Texium closed male luer and SmartSite access devices and accessories

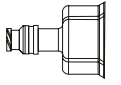









The Texium closed male luer partners with the SmartSite needle-free valve to deliver an easy-to-use closed system. SmartSite IV sets and accessories eliminate the need for needles, caps, blunt cannulas and add-on components. Access devices and accessories provide flexibility and additional infusion capabilities to gravity and infusion instrument sets. All access devices are latex and DEHP free.

Model #	Drops	Description	Case quantity
19MMTP		 <p>Vial dispensing pin with vent Approximate length: 2" 5 cm. approx. Approximate priming volume: 0.22 mL</p>	 100
2000E		 <p>SmartSite® needle-free valve Approximate priming volume: 0.11 mL</p> <p>Labeled for use with low pressure power injectors up to 325 psi and maximum flow rate of 10 mL/second</p>	 100
2201		 <p>Single-dose dispensing pin Approximate priming volume: 0.3 mL</p>	 100
2202E		 <p>SmartSite needle-free access pin Approximate priming volume: 0.07 mL</p>	 100
2203E		 <p>SmartSite 13mm vial access device Approximate priming volume: 0.07 mL</p>	 100
2205E		 <p>SmartSite 20mm vial access device Approximate priming volume: 0.09 mL</p>	 100

03.00 Chemo-Safety System

03.01 Texium closed male luer and SmartSite access devices and accessories









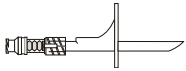

The Texium closed male luer partners with SmartSite needle free valve to deliver an easy-to-use closed system. The SmartSite IV sets and accessories eliminate the need for needles, caps, blunt cannulas and add-on components. Access devices and accessories provide flexibility and additional infusion capabilities to gravity and infusion instruments sets. All access devices are latex and DEHP free.

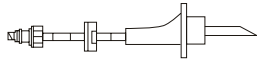
Model #	Drops	Description	Case quantity
MY8003		 <p>Needle-Free Syringe with bonded Texium closed male luer Approximate priming volume: 3 mL</p>	 100
MY8005		 <p>Needle-Free Syringe with bonded Texium closed male luer Approximate priming volume: 5 mL</p>	 100
MY8010		 <p>Needle-Free Syringe with bonded Texium closed male luer Approximate priming volume: 10 mL</p>	 100
MY8020		 <p>Needle-Free Syringe with bonded Texium closed male luer Approximate priming volume: 20 mL</p>	 100
MY8060		 <p>Needle-Free Syringe with bonded Texium closed male luer Approximate priming volume: 60 mL</p>	 50

03.00 Chemo-Safety System

03.01 Texium closed male luer and SmartSite access devices and accessories







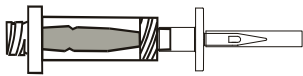

The Texium closed male luer partners with the SmartSite needle-free valve to deliver an easy-to-use closed system. SmartSite IV sets and accessories eliminate the need for needles, caps, blunt cannulas and add-on components. Access devices and accessories provide flexibility and additional infusion capabilities to gravity and infusion instrument sets. All access devices are latex and DEHP free.

Model #	Drops	Description	Case quantity
2300E-0500		 <p>SmartSite bag spike Approximate priming volume: 0.51 mL</p>	 100
2309E		 <p>SmartSite bag spike with check valve Approximate priming volume: 0.93 mL</p>	 100
MM4000		 <p>Manifold with three 1-way valves Approximate length: 6" 15 cm. approx. Approximate priming volume: 1.5 mL</p>	 50
70200		 <p>Female cap</p>	 600
70804		 <p>Female/male cap</p>	 600

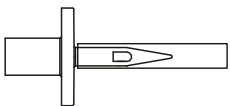
03.00 Chemo-Safety System

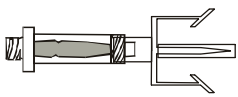
03.02 Vial and bag access devices

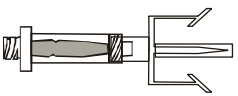
Vial and bag access devices eliminate the need for needles, caps, blunt cannulas and add-on components. Access devices and accessories provide flexibility and additional infusion capabilities to gravity and infusion instrument sets. All access devices are latex and DEHP free.







Model #	Drops	Description		Case quantity
MV0500		 <p>Multi-dose vial access spike, standard clear needleless connector</p>		50
MV0510		 <p>Single dose vial access spike, standard clear needleless connector</p>		100
MV0600		 <p>14 mm multi-dose vial access adapter, standard clear needleless connector</p>		100
MV0700		 <p>20 mm multi-dose vial access adapter, standard clear needleless connector</p>		100

30-day lead time

03.00 Chemo-Safety System

03.02 Vial and bag access devices

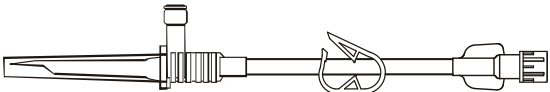
Vial and bag access devices eliminate the need for needles, caps, blunt cannulas and add-on components. Access devices and accessories provide flexibility and additional infusion capabilities to gravity and infusion instrument sets. All access devices are latex and DEHP free.

Model #	Drops	Description	Case quantity
MY3001		 <p>Bag access spike with cap, back check valve, standard clear needleless connector</p>	 100
MY3003		 <p>Bag access spike with cap, standard clear needleless connector</p>	 100
MY3004 30-day lead time		 <p>Bag access spike with cap, pinch clamp</p> <p>Approximate set length: 7" 18 cm. approx.</p>	 50

03.00 Chemo-Safety System

03.03 Secondary administration sets with SmartSite bag access port and Texium closed male luer

The Texium closed male luer partners with the SmartSite needle-free valve to deliver an easy-to-use closed system. The SmartSite IV sets and accessories eliminate the need for needles, caps, blunt cannulas and add-on components. Access devices and accessories provide flexibility and additional infusion capabilities to gravity and infusion instrument sets. All access devices are latex free.







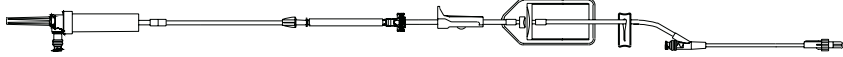

Model #	Drops	Description	Case quantity
10013364	20	 <p>Non-vented secondary set, needle-free valve bag access port, fixed male luer lock and hanger</p> <p>Approximate set length: 32" 81 cm. approx.</p> <p>Approximate priming volume: 12 mL</p>	 100
10013364T	20	 <p>Non-vented secondary set, needle-free valve bag access port, with bonded Texium closed male luer and hanger</p> <p>Approximate set length: 32" 81 cm. approx.</p> <p>Approximate priming volume: 12 mL</p>	100
10014881	20	 <p>Low sorbing non-vented secondary set, needle-free valve bag access port, fixed male luer lock and hanger</p> <p>Approximate set length: 31" 79 cm. approx.</p> <p>Approximate priming volume: 12 mL</p>	 100
10014881T	20	 <p>Low sorbing non-vented secondary set, needle-free valve bag access port, with bonded Texium closed male luer and hanger</p> <p>Approximate set length: 31" 79 cm. approx.</p> <p>Approximate priming volume: 12 mL</p>	 100
11610341	20	 <p>Non-vented secondary set, needle-free valve bag access port, spin male luer lock and hanger</p> <p>Approximate set length: 31" 79 cm. approx.</p> <p>Approximate priming volume: 12 mL</p>	 100

30-day lead time

03.00 Chemo-Safety System

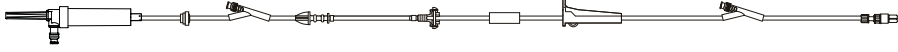
03.04 Alaris Pump module administration sets with SmartSite bag access port and Texium closed male luer







The Texium closed male luer partners with the SmartSite needle-free valve to deliver an easy-to-use closed system. The SmartSite IV sets and accessories eliminate the need for needles, caps, blunt cannulas and add-on components. Access devices and accessories provide flexibility and additional infusion capabilities to gravity and infusion instrument sets. All access devices are latex and DEHP free.

Model #	Drops	Description	Case quantity
2465-0007	20	 <p>Low sorbing infusion set, non-vented, needle-free bag access port, 20 drop, 0.2 micron (low protein binding) filter, 1 needle-free valve 6" from 2-piece male luer lock</p> <p>Approximate set length: 116" 293 cm. approx.</p> <p>Approximate priming volume: 26 mL</p>	 20
2466-0007	20	 <p>Low sorbing infusion set, non-vented, needle-free bag access port, spin male luer lock</p> <p>Approximate set length: 86" 219 cm. approx.</p> <p>Approximate priming volume: 20 mL</p>	 20
10013361	20	 <p>Infusion set, non-vented, needle-free valve bag access port, check valve, 2 needle-free valves 78" and 6" from 2-piece male luer lock</p> <p>Approximate set length: 117" 297 cm. approx.</p> <p>Approximate priming volume: 25 mL</p>	 20
10013854 30-day lead time	20	 <p>Low sorbing infusion set, non-vented, 15 micron filter, needle-free valve bag access port, luer lock connector.</p> <p>Approximate set length: 113" 287 cm. approx.</p> <p>Approximate priming volume: 20 mL</p>	 20

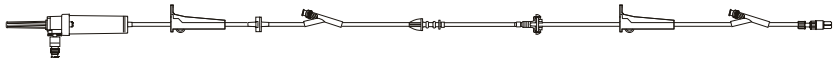
03.00 Chemo-Safety System

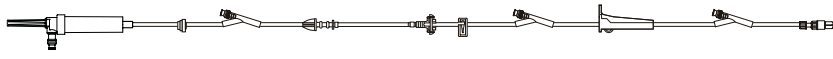
03.04 Alaris Pump module administration sets with SmartSite bag access port and Texium closed male luer





The Texium closed male luer partners with the SmartSite needle-free valve to deliver an easy-to-use closed system. The SmartSite IV sets and accessories eliminate the need for needles, caps, blunt cannulas and add-on components. Access devices and accessories provide flexibility and additional infusion capabilities to gravity and infusion instrument sets. All access devices are latex and DEHP free.

Model #	Drops	Description	Case quantity
10014855 30-day lead time	20	 <p>Low sorbing infusion set, non-vented, needle-free valve bag access port, check valve, 2 needle-free valves 95" and 6" from 2-piece male luer lock</p> <p>Approximate set length: 116" 295 cm. approx.</p> <p>Approximate priming volume: 24 mL</p>	 20
10015861 30-day lead time	20	 <p>Infusion set, non-vented, needle-free valve bag access port, low sorbing tubing, check valve, 3 needle-free valves 95", 75" and 6" from 2-piece male luer lock</p> <p>Approximate set length: 128" 325 cm. approx.</p> <p>Approximate priming volume: 26 mL</p>	 20
10015862	20	 <p>Low sorbing infusion set, non-vented, needle-free valve bag access port, 2-piece male luer lock</p> <p>Approximate set length: 44" 112 cm. approx.</p> <p>Approximate priming volume: 14 mL</p>	 20

03.00 Chemo-Safety System

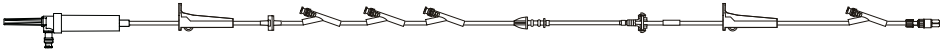
03.04 Alaris Pump module administration sets with SmartSite bag access port and Texium closed male luer



The Texium closed male luer partners with the SmartSite needle-free valve to deliver an easy-to-use closed system. The SmartSite IV sets and accessories eliminate the need for needles, caps, blunt cannulas and add-on components. Access devices and accessories provide flexibility and additional infusion capabilities to gravity and infusion instrument sets. All access devices are latex and DEHP free.

Model #	Drops	Description	Case quantity
10061661 30-day lead time	 20	 <p>Low sorbing infusion set, non-vented, needle-free valve bag access port, check valve, 4 needle-free valves 94", 92", 90" and 6" from 2-piece male luer lock</p> <p>Approximate set length: 121" 307 cm. approx.</p> <p>Approximate priming volume: 25 mL</p>	 20
10321213	 20	 <p>Infusion set, non-vented, needle-free valve bag access port, fixed male luer lock</p> <p>Approximate set length: 106" 269 cm. approx.</p> <p>Approximate priming volume: 23 mL</p>	 20

03.00 Chemo-Safety System

03.05 Alaris SE pump administration sets with SmartSite bag access port and Texium closed male luer

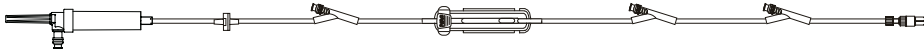
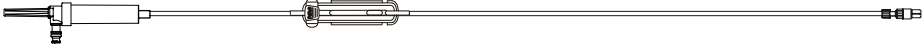





The Texium closed male luer partners with the SmartSite needle-free valve to deliver an easy-to-use closed system. The SmartSite IV sets and accessories eliminate the need for needles, caps, blunt cannulas and add-on components. Access devices and accessories provide flexibility and additional infusion capabilities to gravity and infusion instrument sets. All access devices are latex free.

Model #	Drops	Description	Case quantity
10013363	20	 <p>Infusion set, non-vented, needle-free valve bag access port, smallbore tubing segment, check valve, 2 needle-free valves 90" and 9" from 2-piece male luer lock</p> <p>Approximate set length: 100" 254 cm. approx.</p> <p>Approximate priming volume: 22 mL</p>	50
10015863	20	 <p>Infusion set, low sorbing tubing segment, non-vented, needle-free valve bag access port, check valve, 3 needle-free valves 83", 37" and 9" from 2-piece male luer lock</p> <p>Approximate set length: 101" 257 cm. approx.</p> <p>Approximate priming volume: 22 mL</p>	50
10026645	20	 <p>Infusion set, low sorbing tubing segment, non-vented, needle-free valve bag access port, 2-piece male luer lock</p> <p>Approximate set length: 88" 224 cm. approx.</p> <p>Approximate priming volume: 20 mL</p>	20
10784614	20	 <p>Infusion set, low sorbing tubing segment, non-vented, needle-free valve bag access port, spin male luer lock</p> <p>Approximate set length: 88" 224 cm. approx.</p> <p>Approximate priming volume: 20 mL</p>	20

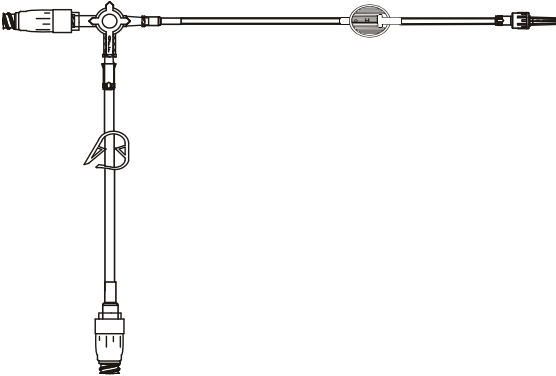
04.00 Specialty extension sets

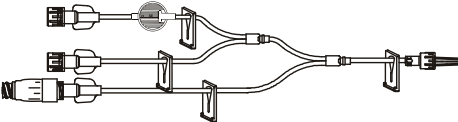
04.01.01 Filters | MaxPlus and MaxGuard connector sets

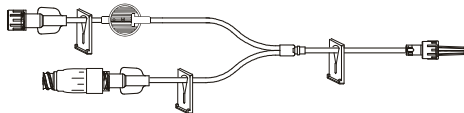





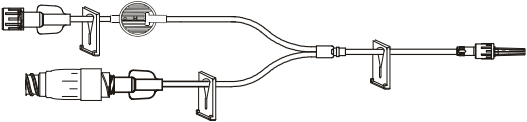

Extension sets provide flexibility and additional infusion capabilities to gravity and infusion instrument sets. All sets are latex free. Configurations are available with integrated MaxPlus and MaxGuard needleless connectors, SmartSite needle-free valves, VersaSafe split septum ports, filters, stopcocks, manifolds and/or T-connectors.

Model #	Drops	Description	Case quantity
			
MP4001-C		Extension set, 2 MaxPlus clear needleless connectors, 3-way stopcock, 0.2 µ filter Approximate set length: 77.75" 197 cm. approx. Approximate priming volume: 5 mL	 50
			
MP9008		Minibore tri-fuse extension set, removable MaxPlus needleless connector, 0.2 micron filter, 4 slide clamps, male spin lock Approximate set length: 9" 23 cm. approx. Approximate priming volume: 1.28 mL	 50
			
MP9009		Minibore bi-fuse extension set, removable MaxPlus needleless connector, 0.2 micron filter, 2 slide clamps, male spin lock Approximate set length: 8" 20 cm. approx. Approximate priming volume: 2.3 mL	 50
30-day lead time			

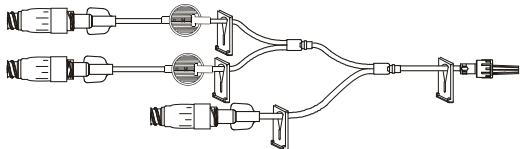
04.00 Specialty extension sets

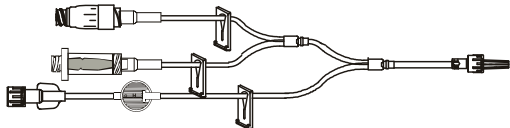
04.01.01 Filters | MaxPlus and MaxGuard connector sets

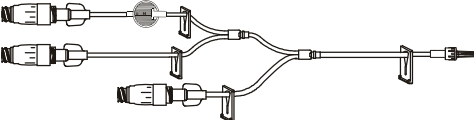







Extension sets provide flexibility and additional infusion capabilities to gravity and infusion instrument sets. All sets are latex free. Configurations are available with integrated MaxPlus and MaxGuard needleless connectors, SmartSite needle-free valves, VersaSafe split septum ports, filters, stopcocks, manifolds and/or T-connectors.

Model #	Drops	Description	Case quantity
MP9009-C 30-day lead time		 <p>Bi-fuse minibore extension set, removable MaxPlus clear needleless connector, 0.2 micron filter, male spin lock</p> <p>Approximate set length: 8" 20 cm. approx.</p> <p>Approximate priming volume: 2.3 mL</p>	 50
MP9204 30-day lead time		 <p>Minibore tri-fuse extension set, 3 removable MaxPlus needleless connectors, two 0.2 micron filters, 4 slide clamps, male spin lock</p> <p>Approximate set length: 7" 18 cm. approx.</p> <p>Approximate priming volume: 0.98 mL</p>	 50
MP9209 30-day lead time		 <p>Minibore tri-fuse extension set, 1 MaxPlus needleless connector, 1 standard needleless connector, 0.2 micron filter, 3 slide clamps, male spin lock</p> <p>Approximate set length: 36" 91 cm. approx.</p> <p>Approximate priming volume: 3.2 mL</p>	 50
MP9212-C 30-day lead time		 <p>Minibore tri-fuse extension set, 3 MaxPlus removable clear needleless connectors, 0.2 micron filter, 4 slide clamps, male luer lock</p> <p>Approximate set length: 9" 23 cm. approx.</p> <p>Approximate priming volume: 1.9 mL</p>	 50

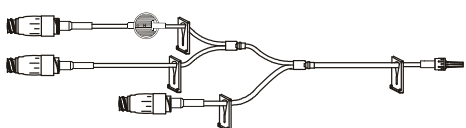
04.00 Specialty extension sets

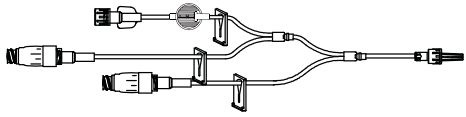
04.01.01 Filters | MaxPlus and MaxGuard connector sets







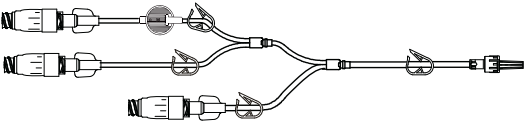

Extension sets provide flexibility and additional infusion capabilities to gravity and infusion instrument sets. All sets are latex free. Configurations are available with integrated MaxPlus and MaxGuard needleless connectors, SmartSite needle-free valves, VersaSafe split septum ports, filters, stopcocks, manifolds and/or T-connectors.

Model #	Drops	Description	Case quantity
MP9234-C 30-day lead time		 <p>Minibore extension set, clear needleless connector, 0.2 micron filter, male spin lock</p> <p>Approximate set length: 60" 152 cm. approx.</p> <p>Approximate priming volume: 2.4 mL</p>	 50
MP9254-C		 <p>Minibore tri-fuse extension set, 3 clear needleless connectors, 0.2 micron filter, 4 slide clamps, male luer lock</p> <p>Approximate set length: 9" 23 cm. approx.</p> <p>Approximate priming volume: 2.0 mL</p>	 50
MP9264-C 30-day lead time		 <p>Minibore tri-fuse extension set, 2 MaxPlus clear needleless connectors, 0.2 micron filter, 3 non-removable slide clamps, male spin lock</p> <p>Approximate set length: 60" 152 cm approx.</p> <p>Approximate priming volume: 3.0 mL</p>	 50
MP9269-C Contact CareFusion for lead time		 <p>Microbore extension set, removable MaxPlus clear needleless connector, pinch clamp, 0.2 micron filter, male spin lock</p> <p>Approximate set length: 60" 152 cm approx.</p> <p>Approximate priming volume: 1.0 mL</p>	 50

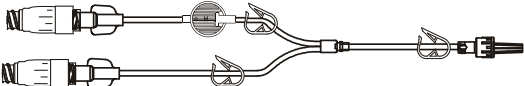
04.00 Specialty extension sets

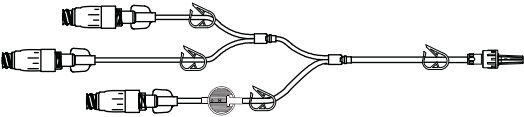
04.01.01 Filters | MaxPlus and MaxGuard connector sets

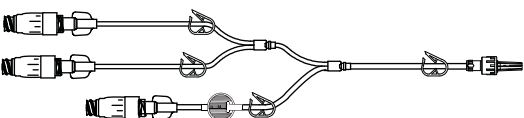





Extension sets provide flexibility and additional infusion capabilities to gravity and infusion instrument sets. All sets are latex free. Configurations are available with integrated MaxPlus and MaxGuard needleless connectors, SmartSite needle-free valves, VersaSafe split septum ports, filters, stopcocks, manifolds and/or T-connectors.

Model #	Drops	Description	Case quantity
MP9270-C Contact CareFusion for lead time		 <p>Microbore tri-fuse extension set, 3 removable MaxPlus clear needleless connectors, 0.2 micron filter, 4 pinch clamps, 2 white, 1 blue, 1 red, male spin lock</p> <p>Approximate set length: 10" 25 cm approx.</p> <p>Approximate priming volume: 0.6 mL</p>	 50
MP9271-C Contact CareFusion for lead time		 <p>Microbore bi-fuse extension set, 2 removable MaxPlus clear needleless connectors, 0.2 micron filter, 3 pinch clamps, male spin lock</p> <p>Approximate set length: 8.5" 22 cm approx.</p> <p>Approximate priming volume: 1.1 mL</p>	 50
MP9272-C Contact CareFusion for lead time		 <p>Microbore tri-fuse extension set, 3 removable MaxPlus clear needleless connectors, 0.2 micron filter, 4 pinch clamps, male spin lock</p> <p>Approximate set length: 60" 152 cm approx.</p> <p>Approximate priming volume: 1.7 mL</p>	 50
MP9273-C Contact CareFusion for lead time		 <p>Microbore tri-fuse extension set, 3 removable MaxPlus clear needleless connectors, 0.2 micron filter, 4 pinch clamps, male spin lock</p> <p>Approximate set length: 60" 152 cm approx.</p> <p>Approximate priming volume: 2.0 mL</p>	 50

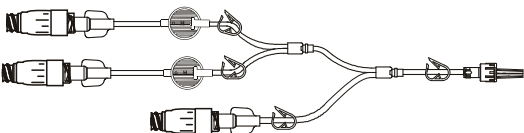
04.00 Specialty extension sets

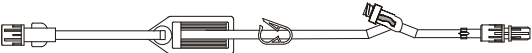
04.01.01 Filters | MaxPlus and MaxGuard connector sets





Extension sets provide flexibility and additional infusion capabilities to gravity and infusion instrument sets. All sets are latex free. Configurations are available with integrated MaxPlus and MaxGuard needleless connectors, SmartSite needle-free valves, VersaSafe split septum ports, filters, stopcocks, manifolds and/or T-connectors.

Model #	Drops	Description	Case quantity
MP9274-C <div style="background-color: #444; color: white; padding: 2px; font-size: 0.8em; margin-top: 5px;">Contact CareFusion for lead time</div>		 <p>Microbore tri-fuse extension set, 3 removable MaxPlus clear needleless connectors, two 0.2 micron filters, 4 pinch clamps, 2 white, 1 blue, 1 red, male spin lock</p> <p>Approximate set length: 8.5" 22 cm approx.</p> <p>Approximate priming volume: 1.6 mL</p>	 50
MX9166		 <p>Extension set, 0.2 micron filter, needleless y-site, pinch clamp, male spin lock</p> <p>Approximate set length: 16" 40.6 cm. approx.</p> <p>Approximate priming volume: 5.8 mL</p>	 50
MX9171		 <p>Extension set, 1.2 micron filter, needleless y-site, pinch clamp, male spin lock</p> <p>Approximate set length: 16" 41 cm. approx.</p> <p>Approximate priming volume: 5.8 mL</p>	 50

04.00 Specialty extension sets

04.01.02 Filters | SmartSite valve sets





Extension sets provide flexibility and additional infusion capabilities to gravity and infusion instrument sets. All sets are latex free. Configurations are available with integrated MaxPlus and MaxGuard needleless connectors, SmartSite needle-free valves, VersaSafe split septum ports, filters, stopcocks, manifolds and/or T-connectors.

Model #	Drops	Description	Case quantity
20027E		 <p>Extension set, 0.2 micron (low-protein binding) filter, 1 needle-free valve 6" from spin male luer lock</p> <p>Approximate set length: 18" 46 cm. approx. Approximate priming volume: 5 mL</p>	 100
20028E		 <p>Extension set, 0.2 micron (low-protein binding) filter, 1 needle-free valve 7" from spin male luer lock</p> <p>Approximate set length: 18" 46 cm. approx. Approximate priming volume: 5 mL</p>	100
20029E		 <p>Smallbore extension set, 0.2 micron (low-protein binding) filter, 1 needle-free valve 1.5" from spin male luer lock</p> <p>Approximate set length: 11" 28 cm. approx. Approximate priming volume: 0.68 mL</p>	 100
20127E		 <p>Extension set, 1.2 micron (low-protein binding) filter, 1 needle-free valve 6" from spin male luer lock</p> <p>Approximate set length: 18" 46 cm. approx. Approximate priming volume: 5 mL</p>	 100
20128E		 <p>Extension set, 1.2 micron (low-protein binding) filter, 1 needle-free valve 7" from spin male luer lock</p> <p>Approximate set length: 18" 46 cm. approx. Approximate priming volume: 5 mL</p>	100

04.00 Specialty extension sets

04.01.02 Filters | SmartSite valve sets



Extension sets provide flexibility and additional infusion capabilities to gravity and infusion instrument sets. All sets are latex free. Configurations are available with integrated MaxPlus and MaxGuard needleless connectors, SmartSite needle-free valves, VersaSafe split septum ports, filters, stopcocks, manifolds and/or T-connectors.

Model #	Drops	Description	Case quantity
20350E		 <p>Low sorbing extension set, 0.2 micron (low-protein binding) filter, 1 needle-free valve 6" from spin male luer lock</p> <p>Approximate set length: 19" 48 cm. approx.</p> <p>Approximate priming volume: 5 mL</p>	 100
21028E		 <p>Extension set, 0.2 micron (low-protein binding) filter, 1 needle-free valve 7" from fixed male luer lock</p> <p>Approximate set length: 18" 46 cm. approx.</p> <p>Approximate priming volume: 5 mL</p>	100
10013902		 <p>Low sorbing extension set, 0.2 micron (low-protein binding) filter, 1 needle-free valve, 2-piece male luer lock</p> <p>Approximate set length: 16" 41 cm. approx.</p> <p>Approximate priming volume: 5 mL</p>	 100

04.00 Specialty extension sets

04.01.03 Filters | VersaSafe split septum sets









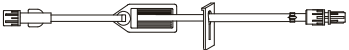

Extension sets provide flexibility and additional infusion capabilities to gravity and infusion instrument sets. All sets are latex free. Configurations are available with integrated MaxPlus and MaxGuard needleless connectors, SmartSite needle-free valves, VersaSafe split septum ports, filters, stopcocks, manifolds and/or T-connectors.

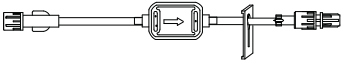
Model #	Drops	Description	Case quantity
10796815 30-day lead time		 <p>Smallbore extension set, 0.2 micron (low-protein binding) filter, 1 split septum port 3" from spin male luer lock</p> <p>Approximate set length: 11" 28 cm. approx.</p> <p>Approximate priming volume: 1 mL</p>	 100
10807851		 <p>Extension set, 0.2 micron (low-protein binding) filter, 1 split septum port 6" from spin male luer lock</p> <p>Approximate set length: 18" 46 cm. approx.</p> <p>Approximate priming volume: 5 mL</p>	 100
10807853		 <p>Extension set, 1.2 micron (low-protein binding) filter, 1 split septum port 6" from spin male luer lock</p> <p>Approximate set length: 18" 46 cm. approx.</p> <p>Approximate priming volume: 6 mL</p>	 100
11275183		 <p>Low sorbing extension set, 0.2 micron (low-protein binding) filter, 1 split septum port 6" from 2-piece male luer lock</p> <p>Approximate set length: 20" 51 cm. approx.</p> <p>Approximate priming volume: 6 mL</p>	 20

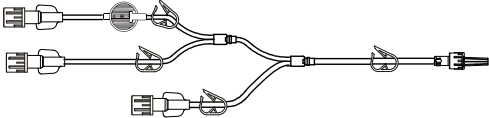
04.00 Specialty extension sets

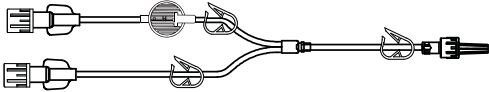
04.01.04 Filters | No port sets

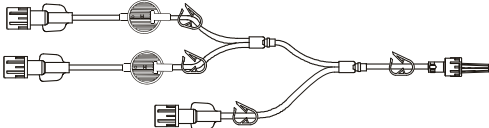





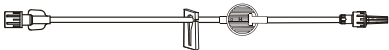

Extension sets provide flexibility and additional infusion capabilities to gravity and infusion instrument sets. All sets are latex free. Configurations are available with integrated MaxPlus and MaxGuard needleless connectors, SmartSite needle-free valves, VersaSafe split septum ports, filters, stopcocks, manifolds and/or T-connectors.

Model #	Drops	Description	Case quantity
ME1225 30-day lead time		 <p>Extension set, 1.2 micron filter, slide clamp, male spin lock</p> <p>Approximate set length: 15" 38 cm. approx.</p> <p>Approximate priming volume: 4.8 mL</p>	 50
ME1250 30-day lead time		 <p>Extension set, 0.2 micron filter, non-removable slide clamp, male spin lock</p> <p>Approximate set length: 6" 15 cm approx.</p> <p>Approximate priming volume: 3.2 mL</p>	 50
ME1254		 <p>Microbore tri-fuse extension set, 0.2 micron filter, 4 pinch clamps, 2 white, 1 blue, 1 red, male spin lock</p> <p>Approximate set length: 10" 25 cm approx.</p> <p>Approximate priming volume: 0.6 mL</p>	 50
ME1255 30-day lead time		 <p>Microbore bi-fuse extension set, 0.2 micron filter, 3 white pinch clamps, male spin lock</p> <p>Approximate set length: 8.5" 22 cm approx.</p> <p>Approximate priming volume: 0.5 mL</p>	 50
ME1256 30-day lead time		 <p>Microbore tri-fuse extension set, two 0.2 micron filters, 4 pinch clamps, 2 white, 1 blue and 1 red, male spin lock</p> <p>Approximate set length: 8.5" 22 cm approx.</p> <p>Approximate priming volume: 0.8 mL</p>	 50

04.00 Specialty extension sets

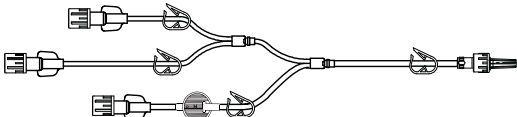
04.01.04 Filters | No port sets

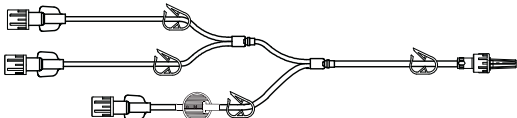







Extension sets provide flexibility and additional infusion capabilities to gravity and infusion instrument sets. All sets are latex free. Configurations are available with integrated MaxPlus and MaxGuard needleless connectors, SmartSite needle-free valves, VersaSafe split septum ports, filters, stopcocks, manifolds and/or T-connectors.

Model #	Drops	Description	Case quantity
ME2064 30-day lead time		 <p>Microbore extension set, 0.2 micron filter, removable slide clamp, male spin lock</p> <p>Approximate set length: 60" 152 cm. approx.</p> <p>Approximate priming volume: 0.6 mL</p>	 50
ME2069 30-day lead time		 <p>Microbore extension set, 0.2 micron filter, white pinch clamp, male spin lock</p> <p>Approximate set length: 60" 152 cm approx.</p> <p>Approximate priming volume: 0.6 mL</p>	 50
ME2070		 <p>Microbore tri-fuse extension set, 0.2 micron filter, 4 white pinch clamps, male spin lock</p> <p>Approximate set length: 60" 152 cm approx.</p> <p>Approximate priming volume: 0.8 mL</p>	 50
ME2071 30-day lead time		 <p>Microbore tri-fuse extension set, 0.2 micron filter, 4 white pinch clamps, male spin lock</p> <p>Approximate set length: 60" 152 cm approx.</p> <p>Approximate priming volume: 1.1 mL</p>	 50

04.00 Specialty extension sets

04.01.04 Filters | No port sets







Extension sets provide flexibility and additional infusion capabilities to gravity and infusion instrument sets. All sets are latex free. Configurations are available with integrated MaxPlus and MaxGuard needleless connectors, SmartSite needle-free valves, VersaSafe split septum ports, filters, stopcocks, manifolds and/or T-connectors.

Model #	Drops	Description	Case quantity
20129E		 <p>Smallbore extension set, 1.2 micron (low-protein binding) filter, fixed male luer lock</p> <p>Approximate set length: 7.5" 19 cm. approx.</p> <p>Approximate priming volume: 0.52 mL</p>	 100
10010570		 <p>Microbore extension set, 0.2 micron (low-protein binding) filter, fixed male luer lock</p> <p>Approximate set length: 60" 152 cm. approx.</p> <p>Approximate priming volume: 0.75 mL</p>	 100
10011865		 <p>Smallbore extension set, 0.2 micron (low-protein binding) filter, spin male luer lock</p> <p>Approximate set length: 7.5" 19 cm. approx.</p> <p>Approximate priming volume: 0.54 mL</p>	 100
10012866		 <p>Extension set, 1.2 micron (low-protein binding) filter, spin male luer lock</p> <p>Approximate set length: 18" 45 cm. approx.</p> <p>Approximate priming volume: 5 mL</p>	 100

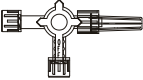
04.00 Specialty extension sets

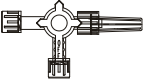
04.02.01 Stopcocks and manifolds | Stand alone

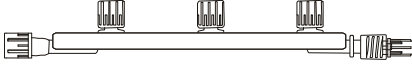





Extension sets provide flexibility and additional infusion capabilities to gravity and infusion instrument sets. All sets are latex free. Configurations are available with integrated MaxPlus and MaxGuard needleless connectors, SmartSite needle-free valves, VersaSafe split septum ports, filters, stopcocks, manifolds and/or T-connectors.

Model #	Drops	Description		Case quantity
M4018		 4-way stopcock, spin lock ("OFF" Indicator)		100
M4020		 3-way stopcock, spin lock ("OFF" Indicator)		100
MM4000		 3-port manifold, male spin lock, 3 one-way valves		50

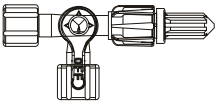
04.00 Specialty extension sets

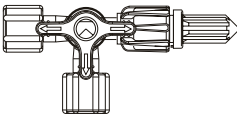
04.02.01 Stopcocks and manifolds | Stand alone

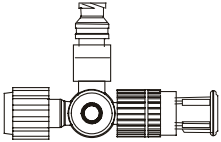





Extension sets provide flexibility and additional infusion capabilities to gravity and infusion instrument sets. All sets are latex free. Configurations are available with integrated MaxPlus and MaxGuard needleless connectors, SmartSite needle-free valves, VersaSafe split septum ports, filters, stopcocks, manifolds and/or T-connectors.

Model #	Drops	Description	Case quantity
10012463		 <p>3-way stopcock. Lipid resistant. ("OFF" Indicator) Approximate priming volume: 0.2 mL</p>	 600
10012496		 <p>4-way stopcock. Lipid resistant Approximate priming volume: 0.3 mL</p>	 600
10237425		 <p>SmartSite 4-way stopcock. Lipid resistant Approximate priming volume: 0.34 mL</p>	 100

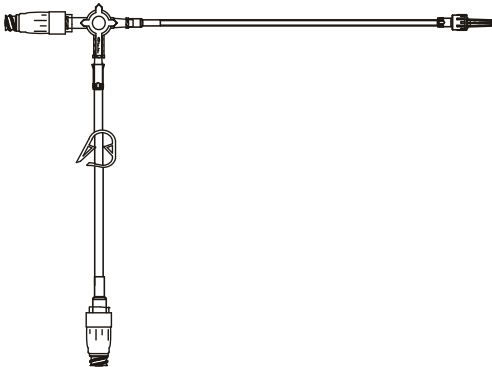
04.00 Specialty extension sets

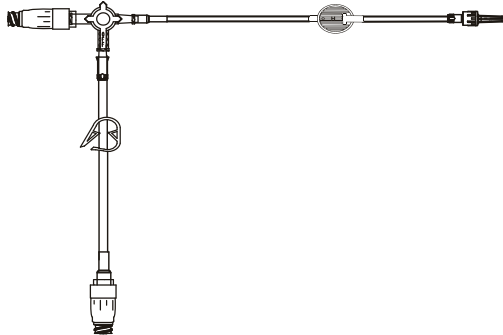
04.02.02 Stopcocks and manifolds | MaxPlus needleless connector and y-site sets

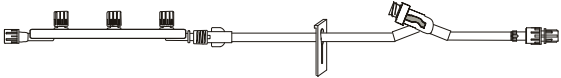
Extension sets provide flexibility and additional infusion capabilities to gravity and infusion instrument sets. All sets are latex free. Configurations are available with integrated MaxPlus and MaxGuard needleless connectors, SmartSite needle-free valves, VersaSafe split septum ports, filters, stopcocks, manifolds and/or T-connectors.







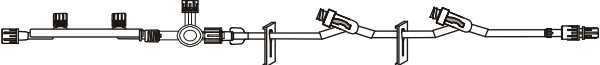

Model #	Drops	Description	Case quantity
MP4000-C		 <p>Extension set, 3-way stopcock ("OFF" Indicator), 2 MaxPlus clear needleless connectors, pinch clamp, male luer slip</p> <p>Approximate set length: 77.5" 197 cm. approx.</p> <p>Approximate priming volume: 4.9 mL</p>	 50
MP4001-C		 <p>Extension set, 2 MaxPlus clear needleless connectors, 3-way stopcock ("OFF" Indicator), 0.2 µ filter</p> <p>Approximate set length: 77.75" 197 cm. approx.</p> <p>Approximate priming volume: 5 mL</p>	 50
MM4300-1		 <p>Extension set, removable 3-port manifold, back check valve, needleless y-site, male spin lock</p> <p>Approximate set length: 37" 94 cm. approx.</p> <p>Approximate priming volume: 6 mL</p>	 50

30-day lead time

04.00 Specialty extension sets

04.02.02 Stopcocks and manifolds | MaxPlus needleless connector and y-site sets

Extension sets provide flexibility and additional infusion capabilities to gravity and infusion instrument sets. All sets are latex free. Configurations are available with integrated MaxPlus and MaxGuard needleless connectors, SmartSite needle-free valves, VersaSafe split septum ports, filters, stopcocks, manifolds and/or T-connectors.

Model #	Drops	Description	Case quantity
MX4414 30-day lead time		 <p>Extension set, 2 needleless y-sites, 4-way stopcock ("OFF" Indicator), removable 2-port manifold, 2 slide clamps, male spin lock</p> <p>Approximate set length: 37" 94 cm. approx.</p> <p>Approximate priming volume: 8 mL</p>	 50
MX4439		 <p>Extension set, 2 needleless y-sites, 4-way stopcock ("OFF" Indicator), slide clamp, male luer lock</p> <p>Approximate set length: 40" 102 cm. approx.</p> <p>Approximate priming volume: 7 mL</p>	 50
MX4440 30-day lead time		 <p>Extension set, needleless y-site, 3-way stopcock ("OFF" Indicator), slide clamp, male luer lock</p> <p>Approximate set length: 36" 91 cm. approx.</p>	 50
MX4450		 <p>Extension set, two 4-way stopcocks ("OFF" Indicator), needleless y-site, removable slide clamp, male luer lock</p> <p>Approximate set length: 64" 163 cm. approx.</p> <p>Approximate priming volume: 6.5 mL</p>	 50

04.00 Specialty extension sets

04.02.03 Stopcocks and manifolds | SmartSite valve sets



Extension sets provide flexibility and additional infusion capabilities to gravity and infusion instrument sets. All sets are latex free. Configurations are available with integrated MaxPlus and MaxGuard needleless connectors, SmartSite needle-free valves, VersaSafe split septum ports, filters, stopcocks, manifolds and/or T-connectors.

Model #	Drops	Description	Case quantity
20511E		 <p>Extension set, 1 needle-free valve, 2-piece male luer lock Extension set with two 1-way valves, one 4-way stopcock, fixed male luer lock</p> <p>Approximate set length: 45" 114 cm. approx.</p> <p>Approximate priming volume: 7 mL</p>	 50
20519E		 <p>Extension set, manifold with three 1-way valves, 1 needle-free valve 6" from 2-piece male luer lock</p> <p>Approximate set length: 42" 107 cm. approx.</p> <p>Approximate priming volume: 6 mL</p>	50
25202E		 <p>Extension set, 4-way stopcock ("OFF" Indicator), 1 needle-free valve 6" from 2-piece male luer lock</p> <p>Approximate set length: 37" 94 cm. approx.</p> <p>Approximate priming volume: 5 mL</p>	50
25207E		 <p>Extension set, 2-ganged 4-way stopcock, 1 needle-free valve 6" from spin male luer lock</p> <p>Approximate set length: 34" 86 cm. approx.</p> <p>Approximate priming volume: 5 mL</p>	 50
25208E		 <p>Extension set, 3-ganged 4-way stopcock, 1 needle-free valve 6" from spin male luer lock</p> <p>Approximate set length: 34" 86 cm. approx.</p> <p>Approximate priming volume: 5 mL</p>	 50

04.00 Specialty extension sets

04.02.03 Stopcocks and manifolds | SmartSite valve sets



Extension sets provide flexibility and additional infusion capabilities to gravity and infusion instrument sets. All sets are latex free. Configurations are available with integrated MaxPlus and MaxGuard needleless connectors, SmartSite needle-free valves, VersaSafe split septum ports, filters, stopcocks, manifolds and/or T-connectors.

Model #	Drops	Description	Case quantity
10016072 30-day lead time		 <p>Extension set, 3-way stopcock, 1 needle-free valve 4" from spin male luer lock</p> <p>Approximate set length: 39" 99 cm. approx. Approximate priming volume: 6 mL</p>	50
10108964		 <p>Extension set, 4-way stopcock ("OFF" Indicator), 2 needle-free valves 28" and 4" from 2-piece male luer lock</p> <p>Approximate set length: 38" 97 cm. approx. Approximate priming volume: 5 mL</p>	50

04.00 Specialty extension sets

04.02.04 Stopcocks and manifolds | Injection site sets









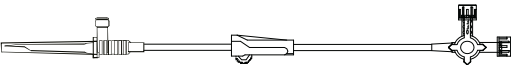

Extension sets provide flexibility and additional infusion capabilities to gravity and infusion instrument sets. All sets are latex free. Configurations are available with integrated MaxPlus and MaxGuard needleless connectors, SmartSite needle-free valves, VersaSafe split septum ports, filters, stopcocks, manifolds and/or T-connectors.

Model #	Drops	Description	Case quantity
MM4024		 <p>Extension set, removable 3-port manifold, slide clamp, injection site, male spin lock</p> <p>Approximate set length: 40" 102 cm. approx.</p>	 50

04.00 Specialty extension sets

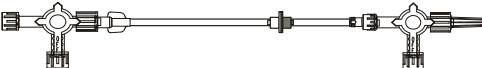
04.02.05 Stopcocks and manifolds | No port sets











Extension sets provide flexibility and additional infusion capabilities to gravity and infusion instrument sets. All sets are latex free. Configurations are available with integrated MaxPlus and MaxGuard needleless connectors, SmartSite needle-free valves, VersaSafe split septum ports, filters, stopcocks, manifolds and/or T-connectors.

Model #	Drops	Description	Case quantity
M4025 30-day lead time		 <p>Secondary transfer set, 4-way stopcock ("OFF" Indicator) roller clamp Approximate set length: 12" 30.4 cm. approx.</p>	 50
M4026 30-day lead time		 <p>Extension set, 3-way stopcock ("OFF" Indicator), male spin lock Approximate set length: 20" 50.8 cm. approx. Approximate priming volume: 3.2 mL</p>	 50
M4058		 <p>Extension set, 4-way stopcock ("OFF" Indicator), male spin lock Approximate set length: 36" 91.44 cm. approx.</p>	 50
M4060 30-day lead time		 <p>Extension set, 2 removable 4-way stopcocks ("OFF" Indicator), male spin lock Approximate set length: 35" 89 cm. approx. Approximate priming volume: 5.5 mL</p>	 50
MM4021		 <p>Extension set, 3-port manifold, male spin lock Approximate set length: 44" 112 cm. approx. Approximate priming volume: 7 mL</p>	 50

04.00 Specialty extension sets

04.02.05 Stopcocks and manifolds | No port sets

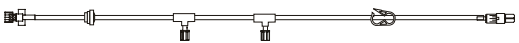



Extension sets provide flexibility and additional infusion capabilities to gravity and infusion instrument sets. All sets are latex free. Configurations are available with integrated MaxPlus and MaxGuard needleless connectors, SmartSite needle-free valves, VersaSafe split septum ports, filters, stopcocks, manifolds and/or T-connectors.

Model #	Drops	Description	Case quantity
25203		 <p>Extension set, 3-way stopcock, spin male luer lock</p> <p>Approximate set length: 20" 51 cm. approx.</p> <p>Approximate priming volume: 2.9 mL</p>	 72
25205 30-day lead time		 <p>Extension set, 3-way stopcock, spin male luer lock</p> <p>Approximate set length: 32" 81 cm. approx.</p> <p>Approximate priming volume: 4 mL</p>	 72
25206		 <p>Extension set, 4-way stopcock, spin male luer lock</p> <p>Approximate set length: 32" 81 cm. approx.</p> <p>Approximate priming volume: 5 mL</p>	 72
10012562 30-day lead time		 <p>Extension set, two 1-way valves, 2-piece male luer lock</p> <p>Approximate set length: 39" 99 cm. approx.</p> <p>Approximate priming volume: 5 mL</p>	 100
10013203		 <p>Extension set, check valve, two 1-way valves, 2-piece male luer lock</p> <p>Approximate set length: 39" 99 cm. approx.</p> <p>Approximate priming volume: 6 mL</p>	 100

04.00 Specialty extension sets

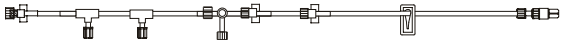
04.02.05 Stopcocks and manifolds | No port sets







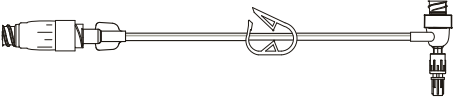

Extension sets provide flexibility and additional infusion capabilities to gravity and infusion instrument sets. All sets are latex free. Configurations are available with integrated MaxPlus and MaxGuard needleless connectors, SmartSite needle-free valves, VersaSafe split septum ports, filters, stopcocks, manifolds and/or T-connectors.

Model #	Drops	Description	Case quantity
10014472 30-day lead time		 <p>Extension set, two 1-way valves, 4-way stopcock, spin male luer lock</p> <p>Approximate set length: 46" 117 cm. approx.</p> <p>Approximate priming volume: 8 mL</p>	 100
10015487 30-day lead time		 <p>Extension set, 3-way stopcock, spin male luer lock</p> <p>Approximate set length: 16" 41 cm. approx.</p> <p>Approximate priming volume: 2 mL</p>	 72

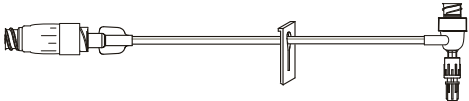
04.00 Specialty extension sets

04.03.01 T-connectors | MaxPlus needleless connector sets

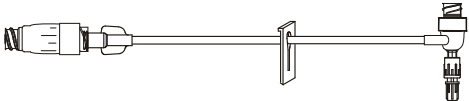





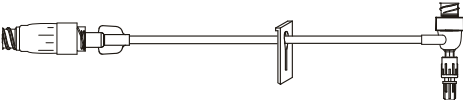

Extension sets provide flexibility and additional infusion capabilities to gravity and infusion instrument sets. All sets are latex free. Configurations are available with integrated MaxPlus and MaxGuard needleless connectors, SmartSite needle-free valves, VersaSafe split septum ports, filters, stopcocks, manifolds and/or T-connectors.

Model #	Drops	Description	Case quantity
MPXT1001-C		 <p>Pressure rated T-connector extension set, removable MaxPlus clear needleless connector, pinch clamp, male spin lock</p> <p>Approximate set length: 6" 15 cm. approx.</p> <p>Approximate priming volume: 1.3 mL</p> <p>Labeled for use with low pressure power injectors up to 325 psi and maximum flow rate of 10 mL/second.</p>	 50
MPXT1003-C		 <p>Minibore pressure rated T-connector extension set, removable MaxPlus clear needleless connector, slide clamp, male spin lock</p> <p>Approximate set length: 6.5" 15 cm. approx.</p> <p>Approximate priming volume: 1.1 mL</p> <p>Labeled for use with low pressure power injectors up to 325 psi and maximum flow rate of 10 mL/second.</p>	 50
MPXT1004-C		 <p>Minibore T-connector extension set, removable MaxPlus clear needleless connector, slide clamp, male luer slip</p> <p>Approximate set length: 6" 15 cm. approx.</p> <p>Approximate priming volume: 1.1 mL</p>	 50
MPXT1005-C		 <p>Minibore T-connector extension set, removable MaxPlus clear needleless connector, slide clamp, male spin lock</p> <p>Approximate set length: 6" 15 cm. approx.</p> <p>Approximate priming volume: 1.1 mL</p>	 50

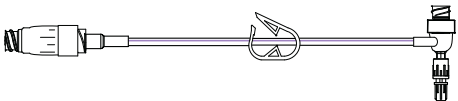
04.00 Specialty extension sets

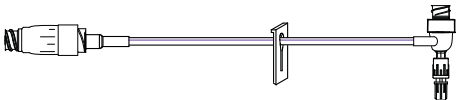
04.03.01 T-connectors | MaxPlus needleless connector sets

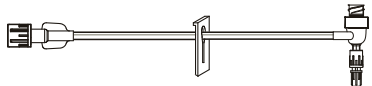





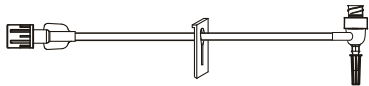

Extension sets provide flexibility and additional infusion capabilities to gravity and infusion instrument sets. All sets are latex free. Configurations are available with integrated MaxPlus and MaxGuard needleless connectors, SmartSite needle-free valves, VersaSafe split septum ports, filters, stopcocks, manifolds and/or T-connectors.

Model #	Drops	Description	Case quantity
MPXT1006		 <p>Minibore pressure rated T-connector extension set, removable needleless connector, slide clamp, male luer lock</p> <p>Approximate set length: 6" 15 cm. approx.</p> <p>Approximate priming volume: 1.1 mL</p> <p>Labeled for use with low pressure power injectors up to 325 psi and maximum flow rate of 10 mL/second.</p>	 50
MPXT5301-C		 <p>Pressure rated T-connector extension set, MaxPlus clear needleless connector, pinch clamp, male spin lock</p> <p>Approximate set length: 7.5" 19 cm. approx.</p> <p>Approximate priming volume: 1.3 mL</p> <p>Labeled for use with low pressure power injectors up to 325 psi and maximum flow rate of 10 mL/second.</p>	 50
MPXT5302-C		 <p>Minibore pressure rated T-connector extension set, with MaxPlus clear needleless connector, non-removable slide clamp, male spin lock</p> <p>Approximate set length: 7.5" 19 cm. approx.</p> <p>Approximate priming volume: 1.1 mL</p> <p>Labeled for use with low pressure power injectors up to 325 psi and maximum flow rate of 10 mL/second.</p>	 50
MXT1003		 <p>Minibore pressure rated T-connector extension set, slide clamp, male spin lock</p> <p>Approximate set length: 6" 15 cm. approx.</p> <p>Approximate priming volume: 0.8 mL</p> <p>Labeled for use with low pressure power injectors up to 325 psi and maximum flow rate of 10 mL/second.</p>	 50

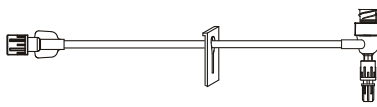
04.00 Specialty extension sets

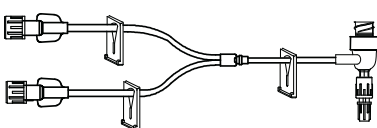
04.03.01 T-connectors | MaxPlus needleless connector sets

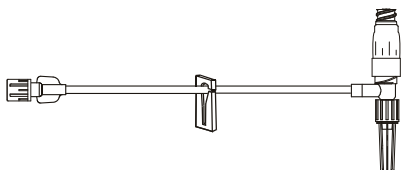





Extension sets provide flexibility and additional infusion capabilities to gravity and infusion instrument sets. All sets are latex free. Configurations are available with integrated MaxPlus and MaxGuard needleless connectors, SmartSite needle-free valves, VersaSafe split septum ports, filters, stopcocks, manifolds and/or T-connectors.

Model #	Drops	Description	Case quantity
MXT1004		 <p>Minibore T-connector extension set, slide clamp, male luer slip</p> <p>Approximate set length: 6" 15 cm. approx.</p> <p>Approximate priming volume: 0.8 mL</p>	 50
MXT1005		 <p>Minibore pressure rated T-connector extension set, slide clamp, male luer lock</p> <p>Approximate set length: 6" 15 cm. approx.</p> <p>Approximate priming volume: 0.8 mL</p> <p>Labeled for use with low pressure power injectors up to 325 psi and maximum flow rate of 10 mL/second.</p>	 50
MXT1006		 <p>Minibore bi-fuse t-connector extension set, 3 slide clamps, injection site, male luer lock</p> <p>Approximate set length: 5.5" 14 cm. approx.</p> <p>Approximate priming volume: 0.53 mL</p>	 50
MP9208-C		 <p>Minibore extension set, clear needleless T-connector, removable slide clamp, male luer slip</p> <p>Approximate set length: 6" 15.2 cm. approx.</p> <p>Approximate priming volume: 1.28 mL</p>	 50

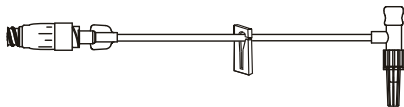
04.00 Specialty extension sets

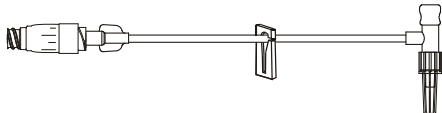
04.03.01 T-connectors | MaxPlus needleless connector sets

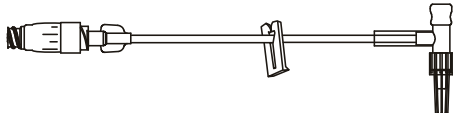





Extension sets provide flexibility and additional infusion capabilities to gravity and infusion instrument sets. All sets are latex free. Configurations are available with integrated MaxPlus and MaxGuard needleless connectors, SmartSite needle-free valves, VersaSafe split septum ports, filters, stopcocks, manifolds and/or T-connectors.

Model #	Drops	Description	Case quantity
MP9216-C 30-day lead time		 <p>Minibore t-connector extension set, removable clear needleless connector, removable slide clamp, injection site, male spin lock</p> <p>Approximate set length: 7" 18 cm. approx.</p> <p>Approximate priming volume: 0.8 mL</p>	 50
MP9221-C		 <p>Minibore T-connector extension set, removable MaxPlus clear needleless connector, removable slide clamp, injection site, male spin lock</p> <p>Approximate set length: 5" 13 cm. approx.</p> <p>Approximate priming volume: 0.3 mL</p>	 50
MP9247-C		 <p>T-connector extension set, removable MaxPlus clear needleless connector, removable slide clamp, injection site, male spin lock</p> <p>Approximate set length: 6" 15 cm. approx.</p> <p>Approximate priming volume: 1.3 mL</p>	 50

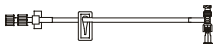
04.00 Specialty extension sets

04.03.02 T-connectors | SmartSite valve sets

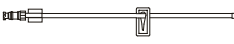



Extension sets provide flexibility and additional infusion capabilities to gravity and infusion instrument sets. All sets are latex free. Configurations are available with integrated MaxPlus and MaxGuard needleless connectors, SmartSite needle-free valves, VersaSafe split septum ports, filters, stopcocks, manifolds and/or T-connectors.

Model #	Drops	Description	Case quantity
20041E		 <p>Smallbore extension set, 1 needle-free valve T-connector, spin male luer lock hub</p> <p>Approximate set length: 6" 15 cm. approx.</p> <p>Approximate priming volume: 0.23 mL</p> <p>Labeled for use with low pressure power injectors up to 325 psi and maximum flow rate of 10 mL/second.</p>	 100
20043E		 <p>Smallbore extension set, 1 needle-free valve hi-flow T-connector, spin male luer lock hub</p> <p>Approximate set length: 6" 15 cm. approx.</p> <p>Approximate priming volume: 0.42 mL</p>	 100
20051E		 <p>Smallbore extension set, 1 needle-free valve T-connector, luer slip adapter</p> <p>Approximate set length: 6" 15 cm. approx.</p> <p>Approximate priming volume: 0.23 mL</p>	 100
20053E		 <p>Smallbore extension set, 1 needle-free valve hi-flow T-connector, luer slip adapter</p> <p>Approximate set length: 5.5" 14 cm. approx.</p> <p>Approximate priming volume: 0.4 mL</p>	 100
10012476 30-day lead time		 <p>Smallbore extension set, 1 detachable needle free-valve, hi-flow T-connector needle free-valve, luer slip adapter</p> <p>Approximate set length: 6" 15 cm. approx.</p> <p>Approximate priming volume: 0.41 mL</p>	 100

04.00 Specialty extension sets

04.03.02 T-connectors | SmartSite valve sets

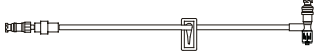

Extension sets provide flexibility and additional infusion capabilities to gravity and infusion instrument sets. All sets are latex free. Configurations are available with integrated MaxPlus and MaxGuard needleless connectors, SmartSite needle-free valves, VersaSafe split septum ports, filters, stopcocks, manifolds and/or T-connectors.

Model #	Drops	Description	Case quantity
10013784 30-day lead time		 <p>Smallbore extension set, 1 needle free-valve 19" from T-connector needle-free valve, spin male luer lock hub</p> <p>Approximate set length: 23" 58 cm. approx.</p> <p>Approximate priming volume: 0.75 mL</p>	 100
C25013E		 <p>Smallbore extension set, 1 detachable needle-free valve, hi-flow T-connector needle-free valve, spin male luer lock hub</p> <p>Approximate set length: 7" 18 cm. approx.</p> <p>Approximate priming volume: 0.48 mL</p>	 100

04.00 Specialty extension sets

04.03.03 T-connectors | VersaSafe split septum sets







Extension sets provide flexibility and additional infusion capabilities to gravity and infusion instrument sets. All sets are latex free. Configurations are available with integrated MaxPlus needleless connectors, SmartSite needle-free valves, VersaSafe split septum ports, filters, stopcocks, manifolds and/or T-connectors.

Model #	Drops	Description	Case quantity
10014813		 Smallbore extension set, split septum injection port T-connector, luer slip adapter Approximate set length: 6" 15 cm. approx. Approximate priming volume: 0.3 mL	 100

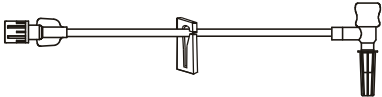
04.00 Specialty extension sets

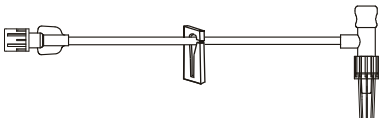
04.03.04 T-connectors | Other access sets

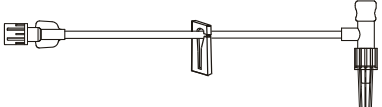







Extension sets provide flexibility and additional infusion capabilities to gravity and infusion instrument sets. All sets are latex free. Configurations are available with integrated MaxPlus and MaxGuard needleless connectors, SmartSite needle-free valves, VersaSafe split septum ports, filters, stopcocks, manifolds and/or T-connectors.

Model #	Drops	Description	Case quantity
ME1046		 <p>Minibore T-connector extension set, injection site, male luer slip</p> <p>Approximate set length: 4" 10.2 cm. approx.</p> <p>Approximate priming volume: 0.33 mL</p>	 50
ME1047 30-day lead time		 <p>Minibore extension set, T-connector, injection site, male luer slip</p> <p>Approximate set length: 6" 15.2 cm. approx.</p> <p>Approximate priming volume: 0.4 mL</p>	 50
ME1214		 <p>Minibore T-connector extension set, removable slide clamp, injection site, male luer lock</p> <p>Approximate set length: 6" 15 cm. approx.</p> <p>Approximate priming volume: 0.3 mL</p>	 50
ME1232		 <p>Minibore T-connector extension set, removable slide clamp, injection site, male spin lock</p> <p>Approximate set length: 5" 13 cm. approx.</p> <p>Approximate priming volume: 0.3 mL</p>	 50
ME1233		 <p>Minibore T-connector extension set, removable slide clamp, injection site, male luer slip</p> <p>Approximate set length: 5" 13 cm. approx.</p> <p>Approximate priming volume: 0.3 mL</p>	 50

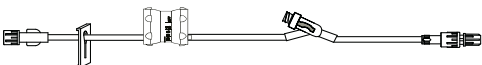
04.00 Specialty extension sets

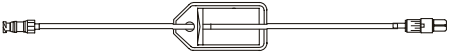
04.04.01 Specialty tubing | Filters and Flow Regulators

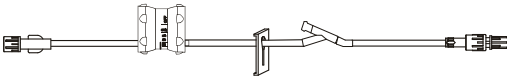





Extension sets provide flexibility and additional infusion capabilities to gravity and infusion instrument sets. All sets are latex free. Configurations are available with integrated MaxPlus and MaxGuard needleless connectors, SmartSite needle-free valves, VersaSafe split septum ports, filters, stopcocks, manifolds and/or T-connectors.

Model #	Drops	Description	Case quantity
20350E		 <p>Low sorbing extension set, 0.2 micron (low-protein binding) filter, 1 needle-free valve 6" from spin male luer lock</p> <p>Approximate set length: 19" 48 cm. approx.</p> <p>Approximate priming volume: 5 mL</p>	 100
MFS141		 <p>Extension set, flow regulator, 1 needleless y-site 7" from spin male lock</p> <p>Approximate set length: 14" 36 cm. approx.</p> <p>Approximate priming volume: 2.6 mL</p>	 100
10013902		 <p>Low sorbing extension set, 0.2 micron (low-protein binding) filter, 1 needle free-valve, 2-piece male luer lock</p> <p>Approximate set length: 16" 41 cm. approx.</p> <p>Approximate priming volume: 5 mL</p>	 100
MFS104		 <p>Extension set, flow regulator, non-removable slide clamp, male spin lock</p> <p>Approximate set length: 20" 50.8 cm. approx.</p>	 50
MFS106		 <p>Extension set, flow regulator, non-removable slide clamp, needleless y-site, male spin lock</p> <p>Approximate set length: 23" 58.4 cm. approx.</p>	 50
MFS107		 <p>Extension set, flow regulator, non-removable slide clamp, injection site, male spin lock</p> <p>Approximate set length: 23" 58.4 cm. approx.</p>	 50

04.00 Specialty extension sets

04.04.02 Specialty tubing | No port sets









Extension sets provide flexibility and additional infusion capabilities to gravity and infusion instrument sets. All sets are latex free. Configurations are available with integrated MaxPlus and MaxGuard needleless connectors, SmartSite needle-free valves, VersaSafe split septum ports, filters, stopcocks, manifolds and/or T-connectors.

Model #	Drops	Description	Case quantity
30893		 <p>Microbore administration set with yellow identification stripe, anti-siphon valve, fixed male luer lock</p> <p>Approximate set length: 112" 284 cm. approx.</p> <p>Approximate priming volume: 2.7 mL</p>	 50
10241342		 <p>Microbore extension set, amber tubing, fixed male luer lock</p> <p>Approximate set length: 62" 156 cm. approx.</p> <p>Approximate priming volume: 0.56 mL</p>	 100
C20014		 <p>Low sorbing extension set, 2-piece male luer lock</p> <p>Approximate set length: 30" 76 cm. approx.</p> <p>Approximate priming volume: 4 mL</p>	 72

04.00 Specialty extension sets

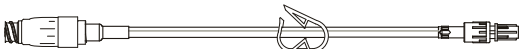
04.05.01 Labeled for use with low pressure power injectors | MaxPlus and MaxGuard needleless connector sets



Extension sets provide flexibility and additional infusion capabilities to gravity and infusion instrument sets. All sets are latex free. Configurations are available with integrated MaxPlus and MaxGuard needleless connectors, SmartSite needle-free valves, VersaSafe split septum ports, filters, stopcocks, manifolds and/or T-connectors.

Model #	Drops	Description	Case quantity
MP1000-C		 <p>MaxPlus clear needleless connector Approximate priming volume: 0.28 mL</p> <p>Labeled for use with low pressure power injectors up to 325 psi and maximum flow rate of 10 mL/second.</p>	 100
MP5301		 <p>Pressure rated extension set, MaxPlus needleless connector, pinch clamp, male spin lock Approximate set length: 7.5" 19 cm. approx. Approximate priming volume: 0.8 mL</p> <p>Labeled for use with low pressure power injectors up to 325 psi and maximum flow rate of 10 mL/second.</p>	 50
MP5301-A		 <p>Pressure rated extension set, MaxGuard antimicrobial needleless connector, pinch clamp, male spin lock Approximate set length: 8.5" 22 cm. approx. Approximate priming volume: 0.8 mL</p> <p>Labeled for use with low pressure power injectors up to 325 psi and maximum flow rate of 10 mL/second.</p>	 50
MP5301-C		 <p>Pressure rated extension set, MaxPlus clear needleless connector, pinch clamp, male spin lock Approximate set length: 8.5" 22 cm. approx. Approximate priming volume: 0.8 mL</p> <p>Labeled for use with low pressure power injectors up to 325 psi and maximum flow rate of 10 mL/second.</p>	 50

04.00 Specialty extension sets

04.05.01 Labeled for use with low pressure power injectors | MaxPlus and MaxGuard needleless connector sets

Extension sets provide flexibility and additional infusion capabilities to gravity and infusion instrument sets. All sets are latex free. Configurations are available with integrated MaxPlus and MaxGuard needleless connectors, SmartSite needle-free valves, VersaSafe split septum ports, filters, stopcocks, manifolds and/or T-connectors.









Model #	Drops	Description	Case quantity
MP5302		 <p>Minibore pressure rated extension set with MaxPlus needleless connector, non-removable slide clamp, male spin lock</p> <p>Approximate set length: 6.5" 16 cm. approx.</p> <p>Approximate priming volume: 0.59 mL</p> <p>Labeled for use with low pressure power injectors up to 325 psi and maximum flow rate of 10 mL/second.</p>	 50
MP5302-A		 <p>Minibore pressure rated extension set, MaxGuard antimicrobial needleless connector, non-removable slide clamp, male spin lock</p> <p>Approximate set length: 8.5" 22 cm. approx.</p> <p>Approximate priming volume: 0.6 mL</p> <p>Labeled for use with low pressure power injectors up to 325 psi and maximum flow rate of 10 mL/second.</p>	 50
MP5302-C		 <p>Minibore pressure rated extension set, MaxPlus clear needleless connector, non-removable slide clamp, male spin lock</p> <p>Approximate set length: 8.5" 22 cm. approx.</p> <p>Approximate priming volume: 0.59 mL</p> <p>Labeled for use with low pressure power injectors up to 325 psi and maximum flow rate of 10 mL/second.</p>	 50
MP5303		 <p>Pressure rated extension set, removable MaxPlus needleless connector, non-removable pinch clamp, male spin lock</p> <p>Approximate set length: 7" 18 cm. approx.</p> <p>Approximate priming volume: 0.7 mL</p> <p>Labeled for use with low pressure power injectors up to 325 psi and maximum flow rate of 10 mL/second.</p>	 50

30-day lead time

04.00 Specialty extension sets

04.05.01 Labeled for use with low pressure power injectors | MaxPlus and MaxGuard needleless connector sets

Extension sets provide flexibility and additional infusion capabilities to gravity and infusion instrument sets. All sets are latex free. Configurations are available with integrated MaxPlus and MaxGuard needleless connectors, SmartSite needle-free valves, VersaSafe split septum ports, filters, stopcocks, manifolds and/or T-connectors.

Model #	Drops	Description	Case quantity
MP5303-A		 <p>Pressure rated extension set, removable MaxGuard antimicrobial needleless connector, pinch clamp, male spin lock</p> <p>Approximate set length: 7" 18 cm. approx.</p> <p>Approximate priming volume: 0.7 mL</p> <p>Labeled for use with low pressure power injectors up to 325 psi and maximum flow rate of 10 mL/second.</p>	 50
MP5303-C		 <p>Pressure rated extension set, removable MaxPlus clear needleless connector, pinch clamp, male spin lock</p> <p>Approximate set length: 7" 18 cm. approx.</p> <p>Approximate priming volume: 0.7 mL</p> <p>Labeled for use with low pressure power injectors up to 325 psi and maximum flow rate of 10 mL/second.</p>	 50
MP5304-C		 <p>Minibore pressure rated extension set with MaxPlus clear needleless connector, non-removable slide clamp, male spin lock</p> <p>Approximate set length: 7" 18 cm. approx.</p> <p>Approximate priming volume: 0.58 mL</p> <p>Labeled for use with low pressure power injectors up to 325 psi and maximum flow rate of 10 mL/second.</p>	 50
MP5305-C		 <p>Pressure rated extension set, removable MaxPlus clear needleless connector, male spin lock</p> <p>Approximate set length: 7" 18 cm. approx.</p> <p>Approximate priming volume: 0.7 mL</p> <p>Labeled for use with low pressure power injectors up to 325 psi and maximum flow rate of 10 mL/second.</p>	 50

04.00 Specialty extension sets

04.05.01 Labeled for use with low pressure power injectors | MaxPlus and MaxGuard needleless connector sets

Extension sets provide flexibility and additional infusion capabilities to gravity and infusion instrument sets. All sets are latex free. Configurations are available with integrated MaxPlus and MaxGuard needleless connectors, SmartSite needle-free valves, VersaSafe split septum ports, filters, stopcocks, manifolds and/or T-connectors.

Model #	Drops	Description	Case quantity
MP5310-A 30-day lead time		 <p>Minibore pressure rated extension set, MaxGuard antimicrobial needleless connector, male spin lock</p> <p>Approximate set length: 8.5" 22 cm. approx.</p> <p>Approximate priming volume: 0.59 mL</p> <p>Labeled for use with low pressure power injectors up to 325 psi and maximum flow rate of 10 mL/second.</p>	 50
MP5310-C		 <p>Minibore pressure rated extension set, MaxPlus clear needleless connector, male spin lock</p> <p>Approximate set length: 8.5" 22 cm. approx.</p> <p>Approximate priming volume: 0.59 mL</p> <p>Labeled for use with low pressure power injectors up to 325 psi and maximum flow rate of 10 mL/second.</p>	 50
MP5311-C 30-day lead time		 <p>Minibore pressure rated extension set, removable MaxPlus clear needleless connector, male spin lock</p> <p>Approximate set length: 8.5" 22 cm. approx.</p> <p>Approximate priming volume: 0.5 mL</p> <p>Labeled for use with low pressure power injectors up to 325 psi and maximum flow rate of 10 mL/second.</p>	 50
MP5312-A		 <p>Pressure rated extension set, MaxGuard antimicrobial needleless connector, male spin lock</p> <p>Approximate set length: 8.5" 22 cm. approx.</p> <p>Approximate priming volume: 0.8 mL</p> <p>Labeled for use with low pressure power injectors up to 325 psi and maximum flow rate of 10 mL/second.</p>	 50

04.00 Specialty extension sets

04.05.01 Labeled for use with low pressure power injectors | MaxPlus and MaxGuard needleless connector sets







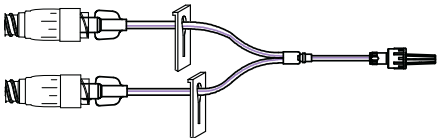

Extension sets provide flexibility and additional infusion capabilities to gravity and infusion instrument sets. All sets are latex free. Configurations are available with integrated MaxPlus and MaxGuard needleless connectors, SmartSite needle-free valves, VersaSafe split septum ports, filters, stopcocks, manifolds and/or T-connectors.

Model #	Drops	Description	Case quantity
MP5312-C		 <p>Pressure rated extension set, clear MaxPlus needleless connector, male spin lock</p> <p>Approximate set length: 8.5" 22 cm. approx.</p> <p>Approximate priming volume: 0.8 mL</p> <p>Labeled for use with low pressure power injectors up to 325 psi and maximum flow rate of 10 mL/second.</p>	 50
MP5313-A		 <p>Minibore pressure rated extension set, removable MaxGuard antimicrobial needleless connector, non-removable slide clamp, male spin lock</p> <p>Approximate set length: 8.5" 22 cm. approx.</p> <p>Approximate priming volume: 0.59 mL</p> <p>Labeled for use with low pressure power injectors up to 325 psi and maximum flow rate of 10 mL/second.</p>	 50
MP5313-C		 <p>Minibore pressure rated extension set, removable MaxPlus clear needleless connector, non-removable slide clamp, male spin lock</p> <p>Approximate set length: 8.5" 22 cm. approx.</p> <p>Approximate priming volume: 0.59 mL</p> <p>Labeled for use with low pressure power injectors up to 325 psi and maximum flow rate of 10 mL/second.</p>	 50
MP5314-C		 <p>Pressure rated extension set, removable MaxPlus clear needleless connector, non-removable slide clamp, male spin lock</p> <p>Approximate set length: 7" 18 cm. approx.</p> <p>Approximate priming volume: 0.7 mL</p> <p>Labeled for use with low pressure power injectors up to 325 psi and maximum flow rate of 10 mL/second.</p>	 50

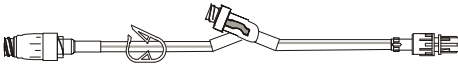
04.00 Specialty extension sets

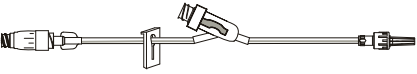
04.05.01 Labeled for use with low pressure power injectors | MaxPlus and MaxGuard needleless connector sets

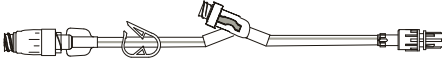







Extension sets provide flexibility and additional infusion capabilities to gravity and infusion instrument sets. All sets are latex free. Configurations are available with integrated MaxPlus and MaxGuard needleless connectors, SmartSite needle-free valves, VersaSafe split septum ports, filters, stopcocks, manifolds and/or T-connectors.

Model #	Drops	Description	Case quantity
			
MP5315-C		Bi-fuse pressure rated extension set, 2 removable MaxPlus clear needleless connectors, 2 non-removable slide clamps, male spin lock Approximate set length: 8.375" 21 cm. approx. Approximate priming volume: 1.1 mL Labeled for use with low pressure power injectors up to 325 psi and maximum flow rate of 10 mL/second.	 50
			
MPX5300-C		Pressure rated extension set, MaxPlus clear needleless connector, pinch clamp, needleless y-site, male spin lock Approximate set length: 9" 23 cm. approx. Approximate priming volume: 1.2 mL Labeled for use with low pressure power injectors up to 325 psi and maximum flow rate of 10 mL/second.	 50
			
MPX5301-C		Minibore pressure rated extension set, removable MaxPlus clear needleless connector, non-removable slide clamp, needleless y-site, male spin lock Approximate set length: 7.5" 19 cm. approx. Approximate priming volume: 1 mL Labeled for use with low pressure power injectors up to 325 psi and maximum flow rate of 10 mL/second.	 50
			
MPX5302-C		Pressure rated extension set, removable MaxPlus needleless connector, pinch clamp, needleless y-site, male spin lock Approximate set length: 9" 23 cm. approx. Approximate priming volume: 1.2 mL Labeled for use with low pressure power injectors up to 325 psi and maximum flow rate of 10 mL/second.	 50

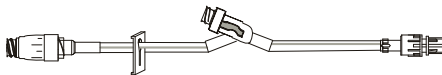
04.00 Specialty extension sets

04.05.01 Labeled for use with low pressure power injectors | MaxPlus and MaxGuard needleless connector sets

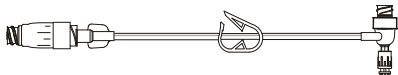





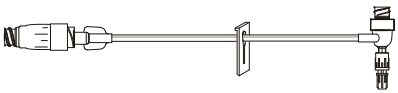

Extension sets provide flexibility and additional infusion capabilities to gravity and infusion instrument sets. All sets are latex free. Configurations are available with integrated MaxPlus and MaxGuard needleless connectors, SmartSite needle-free valves, VersaSafe split septum ports, filters, stopcocks, manifolds and/or T-connectors.

Model #	Drops	Description	Case quantity
MPX5303-C 30-day lead time		 <p>Pressure rated extension set, y-site, MaxPlus clear needleless connector, needleless y-site, male spin lock</p> <p>Approximate set length: 9" 23 cm. approx.</p> <p>Approximate priming volume: 1.2 mL</p> <p>Labeled for use with low pressure power injectors up to 325 psi and maximum flow rate of 10 mL/second.</p>	 50
MPX5304-C		 <p>Pressure rated extension set, MaxcPlus clear needleless connector, non-removable slide clamp, needleless y-site, male spin lock</p> <p>Approximate set length: 11" 28 cm. approx.</p> <p>Approximate priming volume: 1.29 mL</p> <p>Labeled for use with low pressure power injectors up to 325 psi and maximum flow rate of 10 mL/second.</p>	 50
MPX5305-C		 <p>Minibore pressure rated extension set, MaxPlus clear needleless connector, non-removable slide clamp, needleless y-site, male spin lock</p> <p>Approximate set length: 7.5" 19 cm. approx.</p> <p>Approximate priming volume: 1 mL</p> <p>Labeled for use with low pressure power injectors up to 325 psi and maximum flow rate of 10 mL/second.</p>	 50
MPXT1001-C		 <p>Pressure rated T-connector extension set, removable MaxPlus clear needleless connector, pinch clamp, male spin lock</p> <p>Approximate set length: 6" 15 cm. approx.</p> <p>Approximate priming volume: 1.3 mL</p> <p>Labeled for use with low pressure power injectors up to 325 psi and maximum flow rate of 10 mL/second.</p>	 50

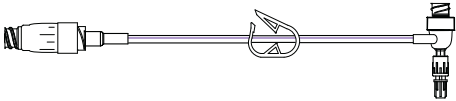
04.00 Specialty extension sets

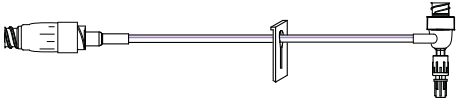
04.05.01 Labeled for use with low pressure power injectors | MaxPlus and MaxGuard needleless connector sets

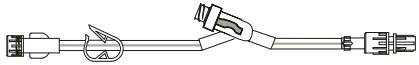





Extension sets provide flexibility and additional infusion capabilities to gravity and infusion instrument sets. All sets are latex free. Configurations are available with integrated MaxPlus and MaxGuard needleless connectors, SmartSite needle-free valves, VersaSafe split septum ports, filters, stopcocks, manifolds and/or T-connectors.

Model #	Drops	Description	Case quantity
MPXT1003-C		 <p>Minibore pressure rated T-connector extension set, removable MaxPlus clear needleless connector, non-removable slide clamp, male spin lock</p> <p>Approximate set length: 6.5" 15 cm. approx.</p> <p>Approximate priming volume: 1.1 mL</p> <p>Labeled for use with low pressure power injectors up to 325 psi and maximum flow rate of 10 mL/second.</p>	 50
MPXT5301-C		 <p>Pressure rated T-connector extension set, MaxPlus clear needleless connector, pinch clamp, male spin lock</p> <p>Approximate set length: 7.5" 19 cm. approx.</p> <p>Approximate priming volume: 1.3 mL</p> <p>Labeled for use with low pressure power injectors up to 325 psi and maximum flow rate of 10 mL/second.</p>	 50
MPXT5302-C		 <p>Minibore pressure rated T-connector extension set, with MaxPlus clear needleless connector, non-removable slide clamp, male spin lock</p> <p>Approximate set length: 7.5" 19 cm. approx.</p> <p>Approximate priming volume: 1.1 mL</p> <p>Labeled for use with low pressure power injectors up to 325 psi and maximum flow rate of 10 mL/second.</p>	 50
MX5301		 <p>Pressure rated extension set, needleless y-site, pinch clamp, male spin lock</p> <p>Approximate set length: 8" 20 cm. approx.</p> <p>Approximate priming volume: 0.8 mL</p> <p>Labeled for use with low pressure power injectors up to 325 psi and maximum flow rate of 10 mL/second.</p>	 50

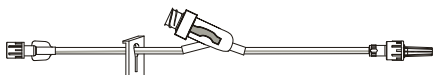
04.00 Specialty extension sets

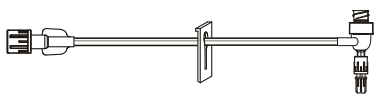
04.05.01 Labeled for use with low pressure power injectors | MaxPlus and MaxGuard needleless connector sets

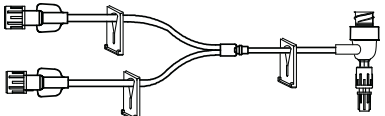
Extension sets provide flexibility and additional infusion capabilities to gravity and infusion instrument sets. All sets are latex free. Configurations are available with integrated MaxPlus and MaxGuard needleless connectors, SmartSite needle-free valves, VersaSafe split septum ports, filters, stopcocks, manifolds and/or T-connectors.

Model #	Drops	Description	Case quantity
MX5302		 <p>Minibore pressure rated extension set, needleless y-site, non-removable slide clamp, male spin lock</p> <p>Approximate set length: 6" 15 cm. approx.</p> <p>Approximate priming volume: 0.7 mL</p> <p>Labeled for use with low pressure power injectors up to 325 psi and maximum flow rate of 10 mL/second.</p>	 50
MXT1003		 <p>Minibore pressure rated T-connector extension set, non-removable slide clamp, male spin lock</p> <p>Approximate set length: 6" 15 cm. approx.</p> <p>Approximate priming volume: 0.8 mL</p> <p>Labeled for use with low pressure power injectors up to 325 psi and maximum flow rate of 10 mL/second.</p>	 50
MXT1006		 <p>Minibore pressure rated bi-fuse T-connector extension set, 3 non-removable slide clamps, male luer lock</p> <p>Approximate set length: 5.5" 14 cm. approx.</p> <p>Approximate priming volume: 0.53 mL</p> <p>Labeled for use with low pressure power injectors up to 325 psi and maximum flow rate of 10 mL/second.</p>	 50

04.00 Specialty extension sets

04.05.02 Labeled for use with low pressure power injectors | SmartSite valve sets









Extension sets provide flexibility and additional infusion capabilities to gravity and infusion instrument sets. All sets are latex free. Configurations are available with integrated MaxPlus and MaxGuard needleless connectors, SmartSite needle-free valves, VersaSafe split septum ports, filters, stopcocks, manifolds and/or T-connectors.

Model #	Drops	Description	Case quantity
2000E		 <p>SmartSite needle-free valve</p> <p>Approximate priming volume: 0.11 mL</p> <p>Labeled for use with low pressure power injectors up to 325 psi and maximum flow rate of 10 mL/second.</p>	 100
20019E		 <p>Smallbore Y-connector extension set, 2 needle-free valves, spin male luer lock</p> <p>Approximate set length: 9" 23 cm. approx.</p> <p>Approximate priming volume: 0.33 mL</p> <p>Labeled for use with low pressure power injectors up to 325 psi and maximum flow rate of 10 mL/second.</p>	 100
20039E		 <p>Smallbore extension set, 1 needle-free valve, spin male luer lock</p> <p>Approximate set length: 6" 15 cm. approx.</p> <p>Approximate priming volume: 0.17 mL</p> <p>Labeled for use with low pressure power injectors up to 325 psi and maximum flow rate of 10 mL/second.</p>	 100
20041E		 <p>Smallbore extension set, 1 needle-free valve T-connector, spin male luer lock hub</p> <p>Approximate set length: 6" 15 cm. approx.</p> <p>Approximate priming volume: 0.23 mL</p> <p>Labeled for use with low pressure power injectors up to 325 psi and maximum flow rate of 10 mL/second.</p>	 100
10011253		 <p>Smallbore extension set, 1 detachable needle-free valve, spin male luer lock</p> <p>Approximate set length: 7.5" 19 cm. approx.</p> <p>Approximate priming volume: 0.29 mL</p> <p>Labeled for use with low pressure power injectors up to 325 psi and maximum flow rate of 10 mL/second.</p>	 100

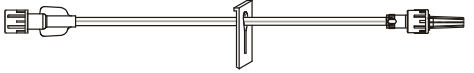
04.00 Specialty extension sets

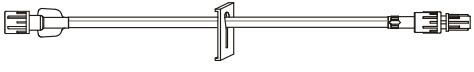
04.05.03 Labeled for use with low pressure power injectors | No port sets



Extension sets provide flexibility and additional infusion capabilities to gravity and infusion instrument sets. All sets are latex free. Configurations are available with integrated MaxPlus and MaxGuard needleless connectors, SmartSite needle-free valves, VersaSafe split septum ports, filters, stopcocks, manifolds and/or T-connectors.

Model #	Drops	Description	Case quantity
ME5301		 <p>Pressure rated extension set, pinch clamp male spin lock</p> <p>Approximate set length: 7.5" 19 cm. approx.</p> <p>Approximate priming volume: 0.4 mL</p>	 50
ME5302		 <p>Minibore pressure rated extension set, non-removable slide clamp, male spin lock</p> <p>Approximate set length: 6.5" 16 cm. approx.</p> <p>Approximate priming volume: 0.2 mL</p>	 50
ME5303		 <p>Pressure rated extension set, non-removable slide clamp, male spin lock</p> <p>Approximate set length: 7.5" 19 cm. approx.</p> <p>Approximate priming volume: 0.4 mL</p>	 50
ME5304		 <p>Pressure rated extension set, male spin lock</p> <p>Approximate set length: 7.5" 19 cm. approx.</p> <p>Approximate priming volume: 0.4 mL</p>	 50

05.00 Extension sets

05.01.01 Standard tubing | MaxPlus and MaxGuard needleless connector sets



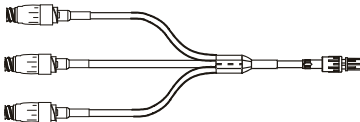
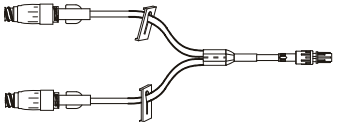



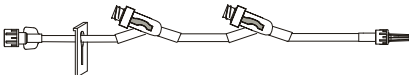

Extension sets provide flexibility and additional infusion capabilities to gravity and infusion instrument sets. All sets are latex free. Configurations are available with integrated MaxPlus and MaxGuard needleless connectors, SmartSite needle-free valves and VersaSafe split septum ports.

Model #	Drops	Description	Case quantity
MP9202 30-day lead time		 <p>Extension set, MaxPlus needleless connector, male luer lock</p> <p>Approximate set length: 7" 18 cm. approx..</p> <p>Approximate priming volume: 1.3 mL</p>	 50
MP9202-C 30-day lead time		 <p>Extension set, MaxPlus clear needleless connector, male luer lock</p> <p>Approximate set length: 7" 18 cm. approx.</p> <p>Approximate priming volume: 1.3 mL</p>	 50
MP9230 30-day lead time		 <p>Tri-fuse extension set, 3 MaxPlus needleless connectors, male spin lock</p> <p>Approximate set length: 7" 18 cm. approx.</p> <p>Approximate priming volume: 2.4 mL</p>	50
MP9238-C		 <p>Bi-fuse extension set, 2 removable MaxPlus clear connectors, 2 non-removable slide clamps, male spin lock</p> <p>Approximate set length: 8.5" 21 cm. approx.</p> <p>Approximate priming volume: 2.3 mL</p>	50
MP9246-C		 <p>Bi-fuse extension set, 2 MaxPlus clear needleless connectors, 2 non-removable slide clamps, male luer lock</p> <p>Approximate set length: 8" 20 cm. approx.</p> <p>Approximate priming volume: 2.2 mL</p>	50

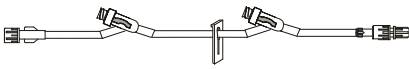
05.00 Extension sets

05.01.01 Standard tubing | MaxPlus and MaxGuard needleless connector sets







Extension sets provide flexibility and additional infusion capabilities to gravity and infusion instrument sets. All sets are latex free. Configurations are available with integrated MaxPlus and MaxGuard needleless connectors, SmartSite needle-free valves and VersaSafe split septum ports.

Model #	Drops	Description	Case quantity
MX9037 30-day lead time		 <p>Extension set, 2 needleless y-sites, non-removable slide clamp, male luer lock</p> <p>Approximate set length: 8.5" 22 cm. approx.</p> <p>Approximate priming volume: 2 mL</p>	 50
MX9059		 <p>Extension set, 2 needleless y-sites, non-removable slide clamp, male spin lock</p> <p>Approximate set length: 8.5" 22 cm. approx.</p> <p>Approximate priming volume: 2 mL</p>	 50
MX9076 30-day lead time		 <p>Extension set, 3 needleless y-sites, 2 pinch clamps, male spin lock</p> <p>Approximate set length: 19" 48 cm. approx.</p> <p>Approximate priming volume: 3.8 mL</p>	 50
MX9172		 <p>Extension set, 2 needleless y-sites, 2 pinch clamps, male spin lock</p> <p>Approximate set length: 40" 102 cm. approx.</p> <p>Approximate priming volume: 7.5 mL</p>	 50

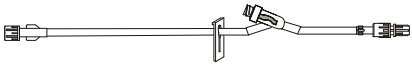
05.00 Extension sets

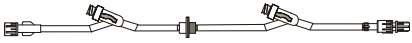
05.01.01 Standard tubing | MaxPlus and MaxGuard needleless connector sets

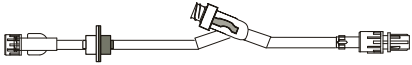
Extension sets provide flexibility and additional infusion capabilities to gravity and infusion instrument sets. All sets are latex free. Configurations are available with integrated MaxPlus and MaxGuard needleless connectors, SmartSite needle-free valves and VersaSafe split septum ports.







Model #	Drops	Description	Case quantity
MX9175		 <p>Extension set, needleless y-site, non-removable slide clamp, male spin lock</p> <p>Approximate set length: 32" 81 cm. approx.</p> <p>Approximate priming volume: 3.5 mL</p>	 50
MX9178		 <p>Extension set, 2 needleless y-sites, back check valve, male spin lock</p> <p>Approximate set length: 50" 127 cm. approx.</p> <p>Approximate priming volume: 8.4 mL</p>	 50
MX9182		 <p>Extension set, needleless y-site, check valve, male spin lock</p> <p>Approximate set length: 8" 20 cm. approx.</p> <p>Approximate priming volume: 1.4 mL</p>	 50

30-day lead time

05.00 Extension sets

05.01.02 Standard tubing | SmartSite valve sets

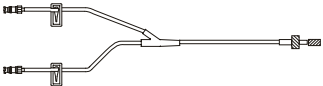





Extension sets provide flexibility and additional infusion capabilities to gravity and infusion instrument sets. All sets are latex free. Configurations are available with integrated MaxPlus and MaxGuard needleless connectors, SmartSite needle-free valves and VersaSafe split septum ports.

Model #	Drops	Description	Case quantity
20057E		 <p>Extension set, 1 needle-free valve, luer slip adapter</p> <p>Approximate set length: 8.5" 22 cm. approx.</p> <p>Approximate priming volume: 1 mL</p>	100
20059E		 <p>Extension set, 1 needle-free valve, spin male luer lock</p> <p>Approximate set length: 8.5" 22 cm. approx.</p> <p>Approximate priming volume: 0.93 mL</p>	100
20060E		 <p>Extension set, 1 needle-free valve, spin male luer lock</p> <p>Approximate set length: 5" 13 cm. approx.</p> <p>Approximate priming volume: 0.63 mL</p>	 100
20061E		 <p>Extension set, Y-connector, 2 needle-free valves, spin male luer lock</p> <p>Approximate set length: 6.5" 17 cm. approx.</p> <p>Approximate priming volume: 1.5 mL</p>	 100

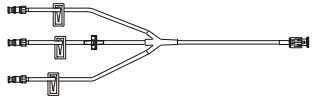
05.00 Extension sets

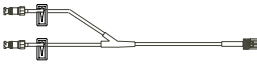
05.01.02 Standard tubing | SmartSite valve sets





Extension sets provide flexibility and additional infusion capabilities to gravity and infusion instrument sets. All sets are latex free. Configurations are available with integrated MaxPlus and MaxGuard needleless connectors, SmartSite needle-free valves and VersaSafe split septum ports.

Model #	Drops	Description	Case quantity
20062E 30-day lead time		 <p>Tri-port extension set, smallbore tubing segments, 3 needle-free valves, check valve, spin male luer lock</p> <p>Approximate set length: 7.5" 19 cm. approx.</p> <p>Approximate priming volume: 1.5 mL</p>	 100
20159E		 <p>Y-connector extension set, 2 needle-free valves, spin male luer lock</p> <p>Approximate set length: 10" 25 cm. approx.</p> <p>Approximate priming volume: 1.9 mL</p>	 100
21059E		 <p>Extension set, 1 needle-free valve, fixed male luer lock</p> <p>Approximate set length: 8" 20 cm. approx.</p> <p>Approximate priming volume: 0.87 mL</p>	100
22059E		 <p>Extension set, 1 detachable needle-free valve, spin male luer lock</p> <p>Approximate set length: 9" 23 cm. approx.</p> <p>Approximate priming volume: 1 mL</p>	100
30202E		 <p>Extension set, 1 needle-free valve 10" from spin male luer lock</p> <p>Approximate set length: 21" 53 cm. approx.</p> <p>Approximate priming volume: 2.6 mL</p>	100

05.00 Extension sets

05.01.02 Standard tubing | SmartSite valve sets







Extension sets provide flexibility and additional infusion capabilities to gravity and infusion instrument sets. All sets are latex free. Configurations are available with integrated MaxPlus and MaxGuard needleless connectors, SmartSite needle-free valves and VersaSafe split septum ports.

Model #	Drops	Description	Case quantity
30204E		 <p>Extension set, 1 needle-free valve 6" from spin male luer lock</p> <p>Approximate set length: 8" 20 cm. approx.</p> <p>Approximate priming volume: 1 mL</p>	100
30205E		 <p>Extension set, 1 needle-free valve 4" from spin male luer lock</p> <p>Approximate set length: 8" 21 cm. approx.</p> <p>Approximate priming volume: 0.93 mL</p>	100
30212E		 <p>Extension set, smallbore tubing segment, 1 needle-free valve 9" from spin male luer lock</p> <p>Approximate set length: 21" 53 cm. approx.</p> <p>Approximate priming volume: 2.2 mL</p>	 100
30262E		 <p>Extension set, 2 needle-free valves 32" and 8" from spin male luer lock</p> <p>Approximate set length: 41" 104 cm. approx.</p> <p>Approximate priming volume: 5 mL</p>	100
30263E		 <p>Extension set, 2 needle-free valves 32" and 8" from 2-piece male luer lock</p> <p>Approximate set length: 41" 104 cm. approx.</p> <p>Approximate priming volume: 5 mL</p>	100
30842E		 <p>Extension set, smallbore tubing segment, check valve, 1 needle-free valve, fixed male luer lock</p> <p>Approximate set length: 12" 30 cm. approx.</p> <p>Approximate priming volume: 1.3 mL</p>	 100

05.00 Extension sets

05.01.02 Standard tubing | SmartSite valve sets







Extension sets provide flexibility and additional infusion capabilities to gravity and infusion instrument sets. All sets are latex free. Configurations are available with integrated MaxPlus and MaxGuard needleless connectors, SmartSite needle-free valves and VersaSafe split septum ports.

Model #	Drops	Description	Case quantity
31202E		 <p>Extension set, 1 needle-free valve 10" from fixed male luer lock</p> <p>Approximate set length: 21" 53 cm. approx.</p> <p>Approximate priming volume: 2.6 mL</p>	100
31262E		 <p>Extension set, 2 needle-free valves 32" and 8" from fixed male luer lock</p> <p>Approximate set length: 41" 104 cm. approx.</p> <p>Approximate priming volume: 5 mL</p>	100
37262E		 <p>Extension set, 2 needle-free valves 32" and 7" from fixed male luer lock</p> <p>Approximate set length: 41" 104 cm. approx.</p> <p>Approximate priming volume: 6 mL</p>	 100
10010912		 <p>Extension set, 1 needle-free valve, spin male luer lock</p> <p>Approximate set length: 8.5" 22 cm. approx.</p> <p>Approximate priming volume: 1.2 mL</p>	 100

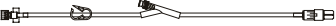
05.00 Extension sets

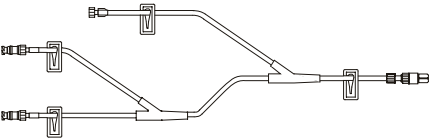
05.01.02 Standard tubing | SmartSite valve sets



Extension sets provide flexibility and additional infusion capabilities to gravity and infusion instrument sets. All sets are latex free. Configurations are available with integrated MaxPlus and MaxGuard needleless connectors, SmartSite needle-free valves and VersaSafe split septum ports.

Model #	Drops	Description	Case quantity
10010971 30-day lead time		 <p>Extension set, detachable tri-port connector, 2 needle-free valves 32" and 7" from spin male luer.</p> <p>Approximate set length: 43" 109 cm. approx. Approximate priming volume: 6 mL</p>	100
10010977 30-day lead time		 <p>Extension set, 1 needle-free valve 10" from 2-piece fixed male luer lock</p> <p>Approximate set length: 21" 53 cm. approx. Approximate priming volume: 2.5 mL</p>	100
10012143		 <p>Y-connector extension set, 1 detachable needle free-valve, female luer port, spin male luer lock</p> <p>Approximate set length: 11" 28 cm. approx. Approximate priming volume: 1.7 mL</p>	100
10014692 30-day lead time		 <p>Tri-port extension set, 2 needle-free valves, 1 female luer lock, 2-piece fixed male luer lock</p> <p>Approximate set length: 10" 25 cm. approx. Approximate priming volume: 2.1 mL</p>	 100
11590099 30-day lead time		 <p>Extension set, 1 needle-free valve 4" from spin male luer lock</p> <p>Approximate set length: 10" 25 cm. approx. Approximate priming volume: 1.4 mL</p>	 100

05.00 Extension sets

05.01.02 Standard tubing | SmartSite valve sets





Extension sets provide flexibility and additional infusion capabilities to gravity and infusion instrument sets. All sets are latex free. Configurations are available with integrated MaxPlus and MaxGuard needleless connectors, SmartSite needle-free valves and VersaSafe split septum ports.

Model #	Drops	Description	Case quantity
C25004E		 <p>Extension set, 1 needle-free valve 10" from spin male luer lock</p> <p>Approximate set length: 182" 462 cm. approx.</p> <p>Approximate priming volume: 24 mL</p>	100
C25015E		 <p>Extension set, 1 detachable needle-free valve, luer slip adapter</p> <p>Approximate set length: 7.5" 19 cm. approx.</p> <p>Approximate priming volume: 0.77 mL</p>	100

05.00 Extension sets

05.01.03 Standard tubing | VersaSafe split septum sets









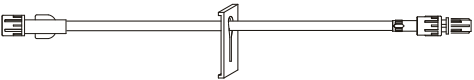

Extension sets provide flexibility and additional infusion capabilities to gravity and infusion instrument sets. All sets are latex free. Configurations are available with integrated MaxPlus and MaxGuard needleless connectors, SmartSite needle-free valves and VersaSafe split septum ports.

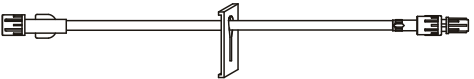
Model #	Drops	Description	Case quantity
10796814		 <p data-bbox="321 558 1013 579">Extension set, 2 split septum ports 23" and 7" from spin male luer lock</p> <p data-bbox="321 600 1003 621">Approximate set length: 41" 103 cm. approx.</p> <p data-bbox="321 642 711 663">Approximate priming volume: 6 mL</p>	 100
10807854		 <p data-bbox="321 814 915 835">Extension set, 1 split septum port 4" from spin male luer lock</p> <p data-bbox="321 856 990 877">Approximate set length: 9" 23 cm. approx.</p> <p data-bbox="321 898 730 919">Approximate priming volume: 1.4 mL</p>	 100

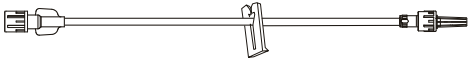
05.00 Extension sets

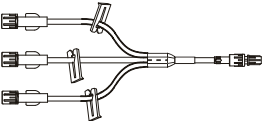
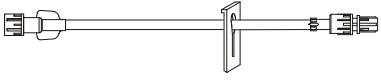
05.01.04 Standard tubing | No port sets











Extension sets provide flexibility and additional infusion capabilities to gravity and infusion instrument sets. All sets are latex free. Configurations are available with integrated MaxPlus and MaxGuard needleless connectors, SmartSite needle-free valves and VersaSafe split septum ports.

Model #	Drops	Description	Case quantity
ME1055		 <p>Extension set, slide clamp, male spin lock</p> <p>Approximate set length: 30" 76 cm. approx.</p> <p>Approximate priming volume: 4.9 mL</p>	 50
ME1069		 <p>Extension set, slide clamp, male spin lock</p> <p>Approximate set length: 20" 51 cm. approx.</p> <p>Approximate priming volume: 2.4 mL</p>	 50
ME1223		 <p>Extension set, removable slide clamp, male spin lock</p> <p>Approximate set length: 7" 18 cm. approx.</p> <p>Approximate priming volume: 1.0 mL</p>	 50
ME1224		 <p>Tri-fuse extension set, 3 removable slide clamps, male spin lock</p> <p>Approximate set length: 6" 15.2 cm. approx.</p> <p>Approximate priming volume: 2 mL</p>	50
ME1229		 <p>Extension set, non-removable slide clamp, male spin lock</p> <p>Approximate set length: 5" 12.7 cm. approx.</p> <p>Approximate priming volume: 0.7 mL</p>	 50
ME1230		 <p>Extension set, pinch clamp, 2 male luer locks</p> <p>Approximate set length: 40" 102 cm. approx.</p>	 50

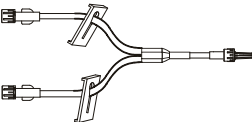
05.00 Extension sets

05.01.04 Standard tubing | No port sets

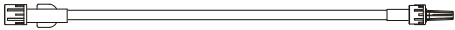
Extension sets provide flexibility and additional infusion capabilities to gravity and infusion instrument sets. All sets are latex free. Configurations are available with integrated MaxPlus and MaxGuard needleless connectors, SmartSite needle-free valves and VersaSafe split septum ports.

Model #	Drops	Description	Case quantity
ME1242 30-day lead time		 <p>Extension set, roller clamp, 2 male luers, spin locks</p> <p>Approximate set length: 40" 102 cm. approx.</p> <p>Approximate priming volume: 6 mL</p>	 50
ME1246 30-day lead time		 <p>Extension set, male spin lock</p> <p>Approximate set length: 3" 8 cm. approx.</p> <p>Approximate priming volume: 0.6 mL</p>	 50
ME1247		 <p>Bi-fuse extension set, 2 non-removable slide clamps, male luer lock</p> <p>Approximate set length: 7" 18 cm. approx.</p> <p>Approximate priming volume: 1.6 mL</p>	 50
ME1248		 <p>Extension set, pinch clamp, male spin lock</p> <p>Approximate set length: 5" 13 cm. approx.</p> <p>Approximate priming volume: 1 mL</p>	 50
ME2068		 <p>Extension set, male luer lock</p> <p>Approximate set length: 60" 152 cm. approx.</p> <p>Approximate priming volume: 9.4 mL</p>	 50
10012213		 <p>Extension set, pinch clamp, 2-piece male luer lock</p> <p>Approximate set length: 60" 152 cm. approx.</p> <p>Approximate priming volume: 8 mL</p>	100

05.00 Extension sets

05.01.04 Standard tubing | No port sets

Extension sets provide flexibility and additional infusion capabilities to gravity and infusion instrument sets. All sets are latex free. Configurations are available with integrated MaxPlus and MaxGuard needleless connectors, SmartSite needle-free valves and VersaSafe split septum ports.

Model #	Drops	Description	Case quantity
10015485 30-day lead time		 <p>Extension set, pinch clamp, 2-piece male luer lock</p> <p>Approximate set length: 8.5" 20 cm. approx.</p> <p>Approximate priming volume: 1 mL</p>	 100
10026685		 <p>Extension set, non-removable slide clamp, 2-piece male luer lock</p> <p>Approximate set length: 8.5" 22 cm. approx.</p> <p>Approximate priming volume: 0.91 mL</p>	72
11608375		 <p>Extension set, 2-piece male luer lock</p> <p>Approximate set length: 20" 51 cm. approx.</p> <p>Approximate priming volume: 2.8 mL</p>	 100
C20014		 <p>Low sorbing extension set, 2-piece male luer lock</p> <p>Approximate set length: 30" 76 cm. approx.</p> <p>Approximate priming volume: 4 mL</p>	 72
C20022		 <p>Extension set, pinch clamp, 2-piece male luer lock</p> <p>Approximate set length: 20" 51 cm. approx.</p> <p>Approximate priming volume: 2.8 mL</p>	 72
C20025		 <p>Extension set, pinch clamp, 2-piece male luer lock</p> <p>Approximate set length: 10" 25 cm. approx.</p> <p>Approximate priming volume: 1.2 mL</p>	72

05.00 Extension sets

05.02.01 Kink resistant tubing | MaxPlus and MaxGuard needleless connector sets





Extension sets provide flexibility and additional infusion capabilities to gravity and infusion instrument sets. All sets are latex free. Configurations are available with integrated MaxPlus and MaxGuard needleless connectors, SmartSite needle-free valves and VersaSafe split septum ports.

Model #	Drops	Description	Case quantity
MP2005 30-day lead time		 <p>Kink resistant extension set, MaxPlus needleless connector, non-removable slide clamp, male luer lock</p> <p>Approximate set length: 7" 18 cm. approx.</p> <p>Approximate priming volume: 1 mL</p>	 50
MP2005-C		 <p>Kink resistant extension set, MaxPlus clear needleless connector, non-removable slide clamp, male luer lock</p> <p>Approximate set length: 7" 18 cm. approx.</p> <p>Approximate priming volume: 1 mL</p>	 50
MP9002		 <p>Kink resistant extension set, MaxPlus needleless connector, removable slide clamp, male spin lock</p> <p>Approximate set length: 7" 18 cm. approx.</p> <p>Approximate priming volume: 0.9 mL</p>	 50
MP9002-A		 <p>Kink resistant extension set, removable MaxGuard antimicrobial needleless connector, removable slide clamp, male spin clamp</p> <p>Approximate set length: 7" 18 cm. approx.</p> <p>Approximate priming volume: 1 mL</p>	 50
MP9002-C		 <p>Kink resistant extension set, MaxPlus clear needleless connector, removable slide clamp, male spin lock</p> <p>Approximate set length: 7" 18 cm. approx.</p> <p>Approximate priming volume: 0.9 mL</p>	 50

05.00 Extension sets

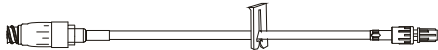
05.02.01 Kink resistant tubing | MaxPlus and MaxGuard needleless connector sets

Extension sets provide flexibility and additional infusion capabilities to gravity and infusion instrument sets. All sets are latex free. Configurations are available with integrated MaxPlus and MaxGuard needleless connectors, SmartSite needle-free valves and VersaSafe split septum ports.

Model #	Drops	Description	Case quantity
MP9081-A		 <p>Kink resistant extension set, MaxGuard antimicrobial needleless connector, removable slide clamp, male spin lock</p> <p>Approximate set length: 8" 20 cm. approx.</p> <p>Approximate priming volume: 1.2 mL</p>	 50
MP9081-C		 <p>Kink resistant extension set, MaxPlus clear needleless connector, removable slide clamp, male spin lock</p> <p>Approximate set length: 8" 20 cm. approx.</p> <p>Approximate priming volume: 1.2 mL</p>	 50
MP9081-SF		 <p>Kink resistant extension set, MaxPlus needleless connector, removable slide clamp, male spin lock</p> <p>Approximate set length: 8" 20 cm. approx.</p> <p>Approximate priming volume: 1.2 mL</p>	 50
MP9213-C 30-day lead time		 <p>Kink resistant extension set, MaxPlus clear needleless connector, pinch clamp, male spin lock</p> <p>Approximate set length: 7" 18 cm. approx.</p> <p>Approximate priming volume: 1 mL</p>	 50
MP9256-C 30-day lead time		 <p>Kink resistant bi-fuse extension set, removable MaxPlus clear needleless connector, removable slide clamp, male spin lock</p> <p>Approximate set length: 7" 18 cm. approx.</p> <p>Approximate priming volume: 1.4 mL</p>	 50

05.00 Extension sets

05.02.01 Kink resistant tubing | MaxPlus and MaxGuard needleless connector sets

Extension sets provide flexibility and additional infusion capabilities to gravity and infusion instrument sets. All sets are latex free. Configurations are available with integrated MaxPlus and MaxGuard needleless connectors, SmartSite needle-free valves and VersaSafe split septum ports.





Model #	Drops	Description	Case quantity
MP9259-C		 <p>Kink resistant extension set, removable MaxPlus clear needleless connector, non-removable slide clamp, male spin lock</p> <p>Approximate set length: 7" 18 cm. approx.</p> <p>Approximate priming volume: 0.9 mL</p>	 50
MPX9100		 <p>Kink resistant extension set, MaxPlus needleless connector, non-removable slide clamp, needleless y-site, male spin lock</p> <p>Approximate set length: 8" 20.3 cm. approx.</p> <p>Approximate priming volume: 1.1 mL</p>	 50
MPX9102-C		 <p>Kink resistant extension set, MaxPlus clear needleless connector, needleless y-site, male spin lock</p> <p>Approximate set length: 9.5" 24 cm. approx.</p> <p>Approximate priming volume: 1.6 mL</p>	 50
MPX9102-SF-C		 <p>Kink resistant extension set, MaxPlus clear needleless connector, needleless y-site, male spin lock</p> <p>Approximate set length: 9.5" 24 cm. approx.</p> <p>Approximate priming volume: 1.6 mL</p>	 50
MPX9103		 <p>Kink resistant extension set, removable MaxPlus needleless connector, needleless y-site, non-removable slide clamp, male spin lock</p> <p>Approximate set length: 8" 20.3 cm. approx.</p> <p>Approximate priming volume: 1.1 mL</p>	 50

30-day lead time

05.00 Extension sets

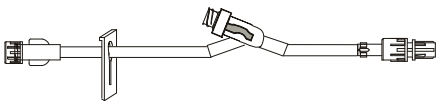
05.02.01 Kink resistant tubing | MaxPlus and MaxGuard needleless connector sets









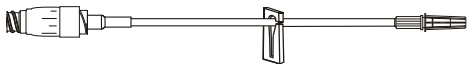

Extension sets provide flexibility and additional infusion capabilities to gravity and infusion instrument sets. All sets are latex free. Configurations are available with integrated MaxPlus and MaxGuard needleless connectors, SmartSite needle-free valves and VersaSafe split septum ports.

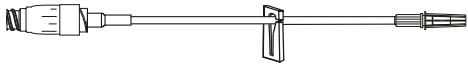
Model #	Drops	Description	Case quantity
MX9060		Kink resistant extension set, needleless y-site, non-removable slide clamp, male spin lock	 50
	Approximate set length: 8" 20.3 cm. approx.		
	Approximate priming volume: 1.2 mL		
MX9164		Kink resistant extension set, standard needleless connector, removable slide clamp, male spin lock	 50
	Approximate set length: 7" 18 cm. approx.		
	Approximate priming volume: 1 mL		

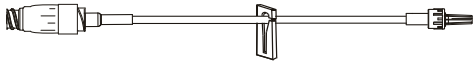
05.00 Extension sets

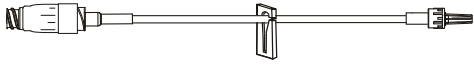
05.03.01 Minibore/Smallbore tubing | MaxPlus and MaxGuard needleless connector sets

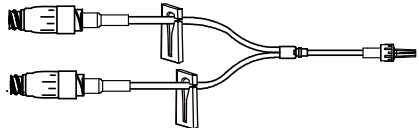
Extension sets provide flexibility and additional infusion capabilities to gravity and infusion instrument sets. All sets are latex free. Configurations are available with integrated MaxPlus and MaxGuard needleless connectors, SmartSite needle-free valves and VersaSafe split septum ports.

Model #	Drops	Description	Case quantity
MP2000		 <p>Minibore extension set, MaxPlus needleless connector, removable slide clamp, male luer slip</p> <p>Approximate set length: 7" 17.8 cm. approx.</p> <p>Approximate priming volume: 0.5 mL</p>	 50
MP2000-C		 <p>Minibore extension set, MaxPlus clear needleless connector, removable slide clamp, male luer slip</p> <p>Approximate set length: 7" 18 cm. approx.</p> <p>Approximate priming volume: 0.59 mL</p>	 50
MP2002		 <p>Minibore extension set, MaxPlus needleless connector, removable slide clamp, male luer lock</p> <p>Approximate set length: 7" 18 cm. approx.</p> <p>Approximate priming volume: 0.51 mL</p>	 50
MP2002-C		 <p>Minibore extension set, MaxPlus clear needleless connector, removable slide clamp, male luer lock</p> <p>Approximate set length: 7" 18 cm. approx.</p> <p>Approximate priming volume: 0.51 mL</p>	 50
MP2202 30-day lead time		 <p>Minibore bi-fuse extension set, 2 MaxPlus needleless connectors, 2 removable slide clamps, male luer lock</p> <p>Approximate set length: 5" 13 cm. approx.</p> <p>Approximate priming volume: 1.2 mL</p>	 50

05.00 Extension sets

05.03.01 Minibore/Smallbore tubing | MaxPlus and MaxGuard needleless connector sets

Extension sets provide flexibility and additional infusion capabilities to gravity and infusion instrument sets. All sets are latex free. Configurations are available with integrated MaxPlus and MaxGuard needleless connectors, SmartSite needle-free valves and VersaSafe split septum ports.

Model #	Drops	Description	Case quantity
			
MP2202-C		Minibore bi-fuse extension set, 2 MaxPlus clear needleless connectors, 2 removable slide clamps, male luer lock Approximate set length: 5" 13 cm. approx. Approximate priming volume: 1.2 mL	 50
			
MP9001		Minibore extension set, removable MaxPlus needleless connector, removable slide clamp, male spin lock Approximate set length: 7" 18 cm. approx. Approximate priming volume: 0.51 mL	 50
			
MP9001-A		Minibore extension set, MaxGuard antimicrobial needleless connector, removable slide clamp, male spin lock Approximate set length: 7" 18 cm. approx. Approximate priming volume: 0.5 mL	 50
			
MP9001-C		Minibore extension set, MaxPlus clear needleless connector, removable slide clamp, male spin lock Approximate set length: 7" 18 cm. approx. Approximate priming volume: 0.51 mL	 50
			
MP9004		Minibore extension set, removable MaxPlus needleless connector, removable slide clamp, male spin lock Approximate set length: 7" 18 cm. approx. Approximate priming volume: 0.51 mL	 50

05.00 Extension sets

05.03.01 Minibore/Smallbore tubing | MaxPlus and MaxGuard needleless connector sets

Extension sets provide flexibility and additional infusion capabilities to gravity and infusion instrument sets. All sets are latex free. Configurations are available with integrated MaxPlus and MaxGuard needleless connectors, SmartSite needle-free valves and VersaSafe split septum ports.









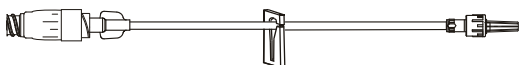

Model #	Drops	Description	Case quantity
MP9004-A		 <p>Minibore extension set, removable MaxGuard antimicrobial needleless connector, removable slide clamp, male spin lock</p> <p>Approximate set length: 7" 18 cm. approx.</p> <p>Approximate priming volume: 0.5 mL</p>	 50
MP9004-C		 <p>Minibore extension set, removable MaxPlus clear needleless connector, removable slide clamp, male spin lock</p> <p>Approximate set length: 7" 18 cm. approx.</p> <p>Approximate priming volume: 0.51 mL</p>	 50
MP9004-NRC		 <p>Minibore extension set, removable MaxPlus needleless connector, non-removable slide clamp, male spin lock</p> <p>Approximate set length: 7" 18 cm. approx.</p> <p>Approximate priming volume: 0.51 mL</p>	 50
MP9014		 <p>Minibore extension set, removable MaxPlus needleless connector, removable slide clamp, male spin lock</p> <p>Approximate set length: 14" 36 cm. approx.</p> <p>Approximate priming volume: 0.75 mL</p>	 50
MP9014-A		 <p>Minibore extension set, removable MaxGuard antimicrobial needleless connector, removable slide clamp, male spin lock</p> <p>Approximate set length: 14" 36 cm. approx.</p> <p>Approximate priming volume: 0.7 mL</p>	 50

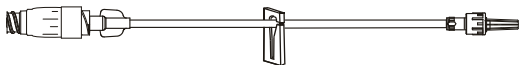
30-day lead time

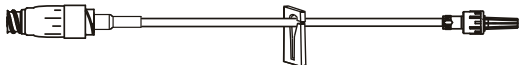
05.00 Extension sets

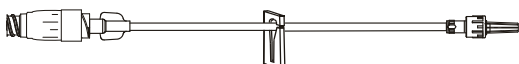
05.03.01 Minibore/Smallbore tubing | MaxPlus and MaxGuard needleless connector sets

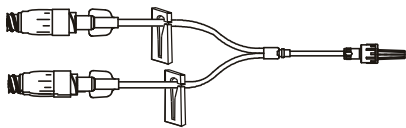







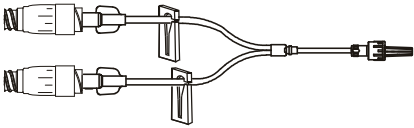

Extension sets provide flexibility and additional infusion capabilities to gravity and infusion instrument sets. All sets are latex free. Configurations are available with integrated MaxPlus and MaxGuard needleless connectors, SmartSite needle-free valves and VersaSafe split septum ports.

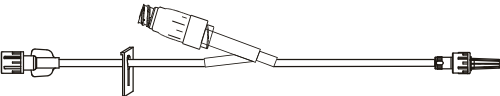
Model #	Drops	Description	Case quantity
MP9014-C		 <p>Minibore extension set, removable MaxPlus clear needleless connector, removable slide clamp, male spin lock</p> <p>Approximate set length: 14" 36 cm. approx.</p> <p>Approximate priming volume: 0.75 mL</p>	 50
MP9017		 <p>Minibore extension set, removable MaxPlus needleless connector, removable slide clamp, male spin lock</p> <p>Approximate set length: 12" 30 cm. approx.</p> <p>Approximate priming volume: 0.75 mL</p>	 50
MP9017-B		 <p>Minibore extension set, MaxPlus needleless connector, removable slide clamp, male spin lock</p> <p>Approximate set length: 12" 30 cm. approx.</p> <p>Approximate priming volume: 0.75 mL</p>	 50
MP9017-C 30-day lead time		 <p>Minibore extension set, removable MaxPlus clear needleless connector, removable slide clamp, male spin lock</p> <p>Approximate set length: 12" 30 cm. approx.</p> <p>Approximate priming volume: 0.7 mL</p>	 50
MP9027		 <p>Minibore bi-fuse extension set, 2 removable MaxPlus needleless connectors, 2 removable slide clamps, male spin lock</p> <p>Approximate set length: 5" 13 cm. approx.</p> <p>Approximate priming volume: 0.8 mL</p>	 50

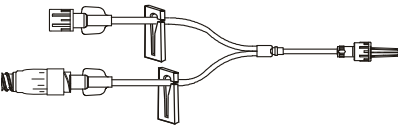
05.00 Extension sets

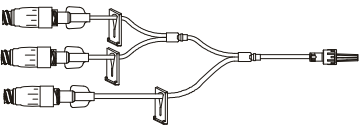
05.03.01 Minibore/Smallbore tubing | MaxPlus and MaxGuard needleless connector sets

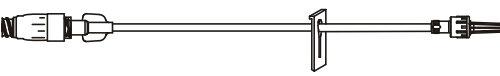
Extension sets provide flexibility and additional infusion capabilities to gravity and infusion instrument sets. All sets are latex free. Configurations are available with integrated MaxPlus and MaxGuard needleless connectors, SmartSite needle-free valves and VersaSafe split septum ports.







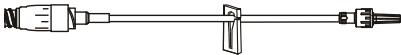

Model #	Drops	Description	Case quantity
MP9027-C		 <p>Minibore bi-fuse extension set, 2 removable MaxPlus clear needleless connectors, 2 removable slide clamps, male spin lock</p> <p>Approximate set length: 5" 13 cm. approx.</p> <p>Approximate priming volume: 0.8 mL</p>	 50
MP9101		 <p>Minibore extension set, MaxPlus needleless y-site, non-removable slide clamp, male spin lock</p> <p>Approximate set length: 6" 15 cm. approx.</p> <p>Approximate priming volume: 0.3 mL</p>	 50
MP9218-C		 <p>Minibore bi-fuse extension set, removable MaxPlus clear needleless connector, 2 removable slide clamps, male spin lock</p> <p>Approximate set length: 7" 18 cm. approx.</p> <p>Approximate priming volume: 0.7 mL</p>	 50
MP9220-C		 <p>Minibore tri-fuse extension set, 3 removable MaxPlus clear connectors, 3 removable slide clamps, male spin lock</p> <p>Approximate set length: 7" 18 cm. approx.</p> <p>Approximate priming volume: 1.5 mL</p>	 50
MP9224		 <p>Minibore extension set, MaxPlus needleless connector, non-removable slide clamp, male spin lock</p> <p>Approximate set length: 6" 15 cm. approx.</p> <p>Approximate priming volume: 0.6 mL</p>	 50

30-day lead time

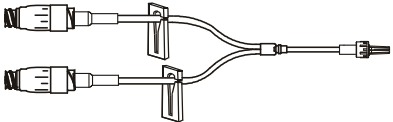
05.00 Extension sets

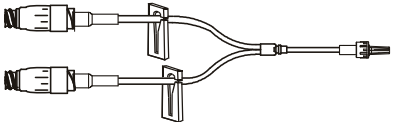
05.03.01 Minibore/Smallbore tubing | MaxPlus and MaxGuard needleless connector sets

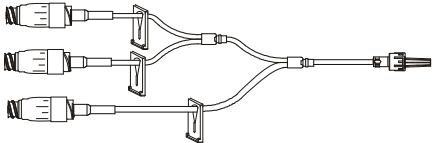







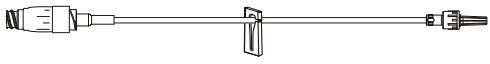

Extension sets provide flexibility and additional infusion capabilities to gravity and infusion instrument sets. All sets are latex free. Configurations are available with integrated MaxPlus and MaxGuard needleless connectors, SmartSite needle-free valves and VersaSafe split septum ports.

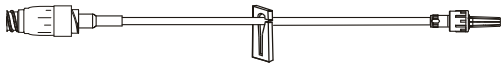
Model #	Drops	Description	Case quantity
MP9229 30-day lead time		 <p>Minibore extension set, MaxPlus needleless connector, removable slide clamp, male spin lock</p> <p>Approximate set length: 14" 36 cm. approx.</p> <p>Approximate priming volume: 0.8 mL</p>	 50
MP9232-A		 <p>Minibore bi-fuse extension set, 2 MaxGuard antimicrobial needleless connectors, 2 removable slide clamps, male luer lock</p> <p>Approximate set length: 6" 15 cm. approx.</p> <p>Approximate priming volume: 1.2 mL</p>	 50
MP9232-C		 <p>Minibore bi-fuse extension set, 2 MaxPlus clear needleless connectors, 2 removable slide clamps, male luer lock</p> <p>Approximate set length: 6" 15 cm. approx.</p> <p>Approximate priming volume: 1.2 mL</p>	 50
MP9233-C		 <p>Minibore tri-fuse extension set, 3 MaxPlus clear needleless connectors, 3 slide clamps, male spin lock</p> <p>Approximate set length: 7" 18 cm. approx.</p> <p>Approximate priming volume: 1.5 mL</p>	 50

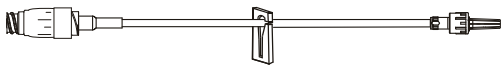
05.00 Extension sets

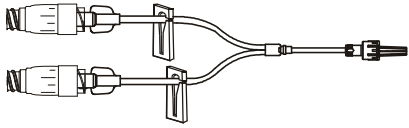
05.03.01 Minibore/Smallbore tubing | MaxPlus and MaxGuard needleless connector sets

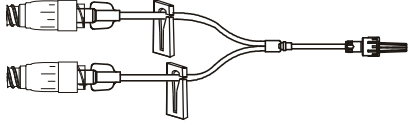
Extension sets provide flexibility and additional infusion capabilities to gravity and infusion instrument sets. All sets are latex free. Configurations are available with integrated MaxPlus and MaxGuard needleless connectors, SmartSite needle-free valves and VersaSafe split septum ports.









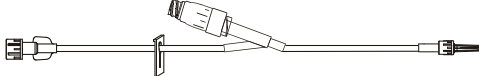

Model #	Drops	Description	Case quantity
MP9235-C		 <p>Minibore extension set, MaxPlus clear needleless connector, removable slide clamp, male spin lock</p> <p>Approximate set length: 60" 152 cm. approx.</p> <p>Approximate priming volume: 2 mL</p>	 50
MP9236-A		 <p>Minibore extension set, MaxGuard antimicrobial needleless connector, removable slide clamp, male spin lock</p> <p>Approximate set length: 14" 36 cm. approx.</p> <p>Approximate priming volume: 0.75 mL</p>	 50
MP9236-C		 <p>Minibore extension set, MaxPlus clear needleless connector, removable slide clamp, male spin lock</p> <p>Approximate set length: 14" 36 cm. approx.</p> <p>Approximate priming volume: 0.75 mL</p>	 50
MP9240-C		 <p>Minibore bi-fuse extension set, 2 removable MaxPlus clear needleless connectors, removable slide clamp, male spin lock</p> <p>Approximate set length: 8" 20 cm. approx.</p> <p>Approximate priming volume: 1.15 mL</p>	 50
MP9250-C		 <p>Minibore bi-fuse extension set, 2 removable MaxPlus clear needleless connectors, 2 removable slide clamps, male spin lock</p> <p>Approximate set length: 7" 18 cm. approx.</p> <p>Approximate priming volume: 1.5 mL</p>	 50

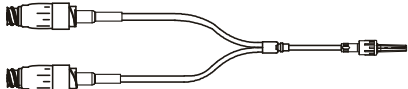
30-day lead time

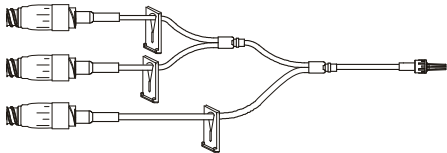
05.00 Extension sets

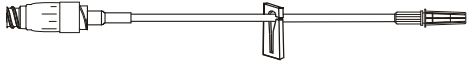
05.03.01 Minibore/Smallbore tubing | MaxPlus and MaxGuard needleless connector sets

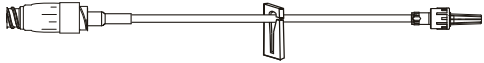





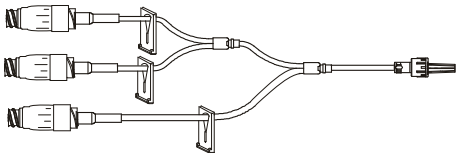

Extension sets provide flexibility and additional infusion capabilities to gravity and infusion instrument sets. All sets are latex free. Configurations are available with integrated MaxPlus and MaxGuard needleless connectors, SmartSite needle-free valves and VersaSafe split septum ports.

Model #	Drops	Description	Case quantity
MP9251-C		 <p>Minibore extension set, MaxPlus clear needleless connector y-site, non-removable slide clamp, male luer lock</p> <p>Approximate set length: 5.5" 14 cm. approx.</p> <p>Approximate priming volume: 0.3 mL</p>	 50
MP9252-C		 <p>Minibore bi-fuse extension set, 2 MaxPlus clear needleless connectors, male spin lock</p> <p>Approximate set length: 6" 15 cm. approx.</p> <p>Approximate priming volume: 1.2 mL</p>	 50
MP9253-C		 <p>Minibore tri-fuse extension set, 3 MaxPlus clear needleless connectors, 3 non-removable slide clamps, male luer lock</p> <p>Approximate set length: 7" 18 cm. approx.</p>	 50
MP9255-C		 <p>Minibore extension set, MaxPlus clear needleless connector, removable slide clamp, male luer slip</p> <p>Approximate set length: 5" 13 cm. approx.</p> <p>Approximate priming volume: 0.6 mL</p>	 50
MP9257-C		 <p>Minibore extension set, MaxPlus clear needleless connector, removable slide clamp, male spin lock</p> <p>Approximate set length: 64" 163 cm. approx.</p> <p>Approximate priming volume: 2.2 mL</p>	 50

05.00 Extension sets

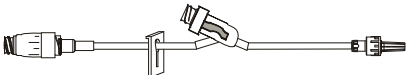
05.03.01 Minibore/Smallbore tubing | MaxPlus and MaxGuard needleless connector sets

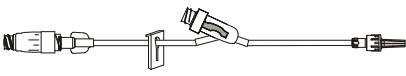
Extension sets provide flexibility and additional infusion capabilities to gravity and infusion instrument sets. All sets are latex free. Configurations are available with integrated MaxPlus and MaxGuard needleless connectors, SmartSite needle-free valves and VersaSafe split septum ports.







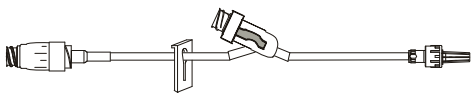

Model #	Drops	Description	Case quantity
MP9260-A		 <p>Minibore tri-fuse extension set, 3 MaxGuard antimicrobial needleless connectors, 3 non-removable slide clamps, male spin lock</p> <p>Approximate set length: 6" 15 cm. approx. Approximate priming volume: 1.5 mL</p>	 50
MP9262-C		 <p>Minibore extension set, MaxPlus clear needleless connector, removable slide clamp, male luer lock</p> <p>Approximate set length: 14" 36 cm. approx. Approximate priming volume: 0.75 mL</p>	 50
MPX9101		 <p>Minibore extension set, MaxPlus needleless connector, needleless y-site, non-removable slide clamp, male spin lock</p> <p>Approximate set length: 7" 18 cm. approx. Approximate priming volume: 0.9 mL</p>	 50
MPX9101-C		 <p>Minibore extension set, MaxPlus clear needleless connector, non-removable slide clamp, needleless y-site, male spin lock</p> <p>Approximate set length: 7" 18 cm. approx. Approximate priming volume: 1 mL</p>	 50
MPX9104		 <p>Minibore extension set, removable MaxPlus needleless connector, non-removable slide clamp, needleless y-site, male spin lock</p> <p>Approximate set length: 7.5" 19 cm. approx. Approximate priming volume: 1 mL</p>	 50

30-day lead time

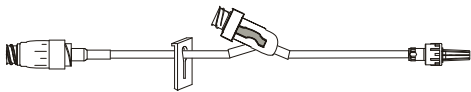
05.00 Extension sets

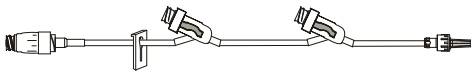
05.03.01 Minibore/Smallbore tubing | MaxPlus and MaxGuard needleless connector sets

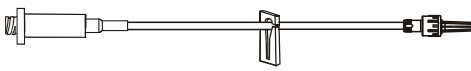



Extension sets provide flexibility and additional infusion capabilities to gravity and infusion instrument sets. All sets are latex free. Configurations are available with integrated MaxPlus and MaxGuard needleless connectors, SmartSite needle-free valves and VersaSafe split septum ports.

Model #	Drops	Description	Case quantity
MPX9105 30-day lead time		 <p>Minibore extension set, MaxPlus needleless connector, non-removable slide clamp, needleless y-site, male spin lock</p> <p>Approximate set length: 6.125" 16 cm. approx.</p> <p>Approximate priming volume: 1 mL</p>	 50
MPX9105-C 30-day lead time		 <p>Minibore extension set, MaxPlus clear needleless connector, non-removable slide clamp, needleless y-site, male spin lock</p> <p>Approximate set length: 6.125" 16 cm. approx.</p> <p>Approximate priming volume: 1 mL</p>	 50
MPX9107-C 30-day lead time		 <p>Minibore extension set, MaxPlus clear needleless connector, 2 needleless y-sites, non-removable slide clamp, male spin lock</p> <p>Approximate set length: 9.5" 24 cm. approx.</p> <p>Approximate priming volume: 1.5 mL</p>	 50
MX9165		 <p>Minibore extension set, standard needleless connector, removable slide clamp, male luer slip</p> <p>Approximate set length: 7" 18 cm. approx.</p> <p>Approximate priming volume: 0.51 mL</p>	 50

05.00 Extension sets

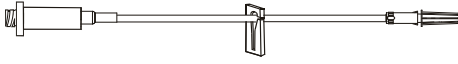
05.03.01 Minibore/Smallbore tubing | MaxPlus and MaxGuard needleless connector sets

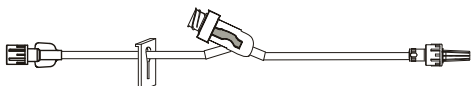
Extension sets provide flexibility and additional infusion capabilities to gravity and infusion instrument sets. All sets are latex free. Configurations are available with integrated MaxPlus and MaxGuard needleless connectors, SmartSite needle-free valves and VersaSafe split septum ports.

Model #	Drops	Description	Case quantity
MX9167 30-day lead time		 <p>Minibore extension set, standard needleless connector, removable slide clamp, male luer slip</p> <p>Approximate set length: 7" 18 cm. approx.</p>	 50
MX9181 30-day lead time		 <p>Minibore extension set, needleless y-site, slide clamp, male spin lock</p> <p>Approximate set length: 9" 23 cm. approx.</p> <p>Approximate priming volume: 0.73 mL</p>	 50

05.00 Extension sets

05.03.02 Minibore/Smallbore tubing | SmartSite valve sets









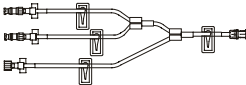

Extension sets provide flexibility and additional infusion capabilities to gravity and infusion instrument sets. All sets are latex free. Configurations are available with integrated MaxPlus and MaxGuard needleless connectors, SmartSite needle-free valves and VersaSafe split septum ports.

Model #	Drops	Description	Case quantity
			
20019E		Minibore/Smallbore Y-connector extension set, 2 needle-free valves, spin male luer lock Approximate set length: 9" 23 cm. approx. Approximate priming volume: 0.33 mL Labeled for use with low pressure power injectors up to 325 psi and maximum flow rate of 10 mL/second.	 100
			
20021E		Minibore/Smallbore extension set, J-loop, 1 needle-free valve, spin male luer lock Approximate set length: 6.5" 17 cm. approx. Approximate priming volume: 0.19 mL	 100
			
20035E		Minibore/Smallbore extension set, 1 needle-free valve, spin male luer lock Approximate set length: 6" 15 cm. approx. Approximate priming volume: 0.35 mL	 100
			
20037E		Minibore/Smallbore extension set, 1 needle-free valve, luer slip adapter. Approximate set length: 6.5" 17 cm. approx. Approximate priming volume: 0.22 mL	 100
			
20038E		Minibore/Smallbore tri-port extension set, 3 needle-free valves, fixed male luer lock Approximate set length: 4.5" 11 cm. approx. Approximate priming volume: 0.37 mL	 100
			
20039E		Minibore/Smallbore extension set, 1 needle-free valve, spin male luer lock Approximate set length: 6" 15 cm. approx. Approximate priming volume: 0.17 mL Labeled for use with low pressure power injectors up to 325 psi and maximum flow rate of 10 mL/second.	 100

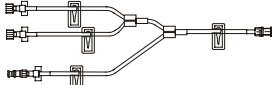
05.00 Extension sets

05.03.02 Minibore/Smallbore tubing | SmartSite valve sets











Extension sets provide flexibility and additional infusion capabilities to gravity and infusion instrument sets. All sets are latex free. Configurations are available with integrated MaxPlus and MaxGuard needleless connectors, SmartSite needle-free valves and VersaSafe split septum ports.

Model #	Drops	Description	Case quantity
20049E		 <p>Minibore/Smallbore extension set, 1 needle-free valve, spin male luer lock</p> <p>Approximate set length: 13" 32 cm. approx.</p> <p>Approximate priming volume: 0.34 mL</p>	 100
20337E		 <p>Minibore/Smallbore tri-port extension set, 2 needle-free valves, 1 female luer lock port, 2-piece fixed male luer lock</p> <p>Approximate set length: 7.5" 19 cm. approx.</p> <p>Approximate priming volume: 0.49 mL</p>	 100
20338E		 <p>Minibore/Smallbore tri-port extension set, 1 detachable needle-free valve, 2 female luer lock ports, spin male luer lock</p> <p>Approximate set length: 8" 20 cm. approx.</p> <p>Approximate priming volume: 0.67 mL</p>	 100
30203E		 <p>Minibore/Smallbore extension set, 1 needle-free valve 4" from fixed male luer lock</p> <p>Approximate set length: 9" 24 cm. approx.</p> <p>Approximate priming volume: 0.67 mL</p>	 100
10010511		 <p>Minibore/Smallbore extension set, 1 needle-free valve, fixed male luer lock</p> <p>Approximate set length: 6" 15 cm. approx.</p> <p>Approximate priming volume: 0.18 mL</p>	 100

05.00 Extension sets

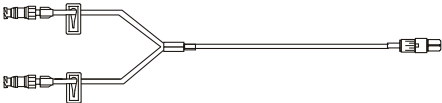
05.03.02 Minibore/Smallbore tubing | SmartSite valve sets





Extension sets provide flexibility and additional infusion capabilities to gravity and infusion instrument sets. All sets are latex free. Configurations are available with integrated MaxPlus and MaxGuard needleless connectors, SmartSite needle-free valves and VersaSafe split septum ports.

Model #	Drops	Description	Case quantity
10010983		 <p>Minibore/Smallbore extension set, 1 detachable needle-free valve, fixed male luer lock</p> <p>Approximate set length: 8.5" 22 cm. approx.</p> <p>Approximate priming volume: 0.33 mL</p>	 100
10011253		 <p>Minibore/Smallbore extension set, 1 detachable needle-free valve, spin male luer lock</p> <p>Approximate set length: 7.5" 19 cm. approx.</p> <p>Approximate priming volume: 0.29 mL</p>	 100
Labeled for use with low pressure power injectors up to 325 psi and maximum flow rate of 10 mL/second			
10014766		 <p>Minibore/Smallbore extension set, 1 needle-free valve, 2-piece male luer lock</p> <p>Approximate set length: 6.5" 17 cm. approx.</p> <p>Approximate priming volume: 0.22 mL</p>	 100
30-day lead time			
10015488		 <p>Minibore/Smallbore Y-connector extension set, 2 detachable needle-free valves, spin male luer lock</p> <p>Approximate set length: 8" 20 cm. approx.</p> <p>Approximate priming volume: 0.54 mL</p>	 100
10406890		 <p>Minibore/Smallbore extension set, smallbore tubing segment, 1 needle-free valve 2" from spin male luer lock</p> <p>Approximate set length: 111" 282 cm. approx.</p> <p>Approximate priming volume: 6 mL</p>	 100
30-day lead time			

05.00 Extension sets

05.03.02 Minibore/Smallbore tubing | SmartSite valve sets









Extension sets provide flexibility and additional infusion capabilities to gravity and infusion instrument sets. All sets are latex free. Configurations are available with integrated MaxPlus and MaxGuard needleless connectors, SmartSite needle-free valves and VersaSafe split septum ports.

Model #	Drops	Description	Case quantity
C25002E 30-day lead time		 <p>Minibore/Smallbore extension set, 4 needle-free valves 227", 219", 15" and 6" from fixed male luer lock</p> <p>Approximate set length: 236" 599 cm. approx.</p> <p>Approximate priming volume: 13 mL</p>	 50
C25005E		 <p>Minibore/Smallbore extension set, 2 needle-free valves 136" and 5" from 2-piece male luer lock</p> <p>Approximate set length: 144" 366 cm. approx.</p> <p>Approximate priming volume: 8 mL</p>	 100

05.00 Extension sets

05.03.03 Minibore/Smallbore tubing | VersaSafe split septum sets





Extension sets provide flexibility and additional infusion capabilities to gravity and infusion instrument sets. All sets are latex free. Configurations are available with integrated MaxPlus and MaxGuard needleless connectors, SmartSite needle-free valves and VersaSafe split septum ports.

Model #	Drops	Description	Case quantity
10807855		 <p>Minibore/Smallbore extension set, 1 split septum port 5" from spin male luer lock</p> <p>Approximate set length: 11" 28 cm. approx.</p> <p>Approximate priming volume: 0.6 mL</p>	 100
10807859	30-day lead time	 <p>Minibore/Smallbore extension set, 1 split septum port 10" from spin male luer lock</p> <p>Approximate set length: 22" 56 cm. approx.</p> <p>Approximate priming volume: 0.9 mL</p>	 100
11202651		 <p>Minibore/Smallbore extension set, 2 split septum ports 137" and 6" from 2-piece male luer lock</p> <p>Approximate set length: 146" 371 cm. approx.</p> <p>Approximate priming volume: 9 mL</p>	 100
11202652		 <p>Minibore/Smallbore extension set, 1 split septum port 9" from fixed male luer lock</p> <p>Approximate set length: 33" 84 cm. approx.</p> <p>Approximate priming volume: 2 mL</p>	 72

05.00 Extension sets

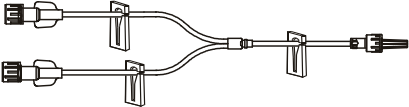
05.03.04 Minibore/Smallbore tubing | No port sets

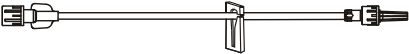









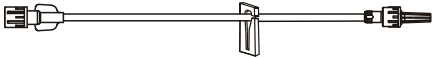

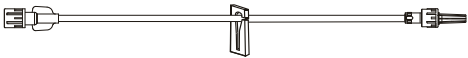
Extension sets provide flexibility and additional infusion capabilities to gravity and infusion instrument sets. All sets are latex free. Configurations are available with integrated MaxPlus and MaxGuard needleless connectors, SmartSite needle-free valves and VersaSafe split septum ports.

Model #	Drops	Description	Case quantity
ME1001 30-day lead time		 <p>Minibore bi-fuse extension set, 3 removable slide clamps, male spin lock</p> <p>Approximate set length: 6" 15 cm. approx.</p> <p>Approximate priming volume: 0.6 mL</p>	 50
ME1021		 <p>Minibore tri-fuse extension set, 4 removable slide clamps, male spin lock</p> <p>Approximate set length: 6" 15 cm. approx.</p> <p>Approximate priming volume: 0.5 mL</p>	 50
ME1028 30-day lead time		 <p>Minibore extension set, removable slide clamp, male spin lock</p> <p>Approximate set length: 4" 10 cm. approx.</p> <p>Approximate priming volume: 0.27 mL</p>	 50
ME1032		 <p>Minibore extension set, removable slide clamp, male spin lock</p> <p>Approximate set length: 6" 15 cm. approx.</p> <p>Approximate priming volume: 0.32 mL</p>	 50
ME1048		 <p>Minibore extension set, removable slide clamp, male spin lock</p> <p>Approximate set length: 12" 30.5 cm. approx.</p> <p>Approximate priming volume: 0.4 mL</p>	 50

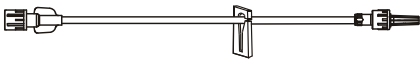
05.00 Extension sets

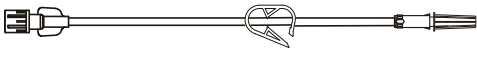
05.03.04 Minibore/Smallbore tubing | No port sets

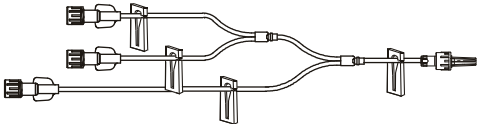
Extension sets provide flexibility and additional infusion capabilities to gravity and infusion instrument sets. All sets are latex free. Configurations are available with integrated MaxPlus and MaxGuard needleless connectors, SmartSite needle-free valves and VersaSafe split septum ports.

Model #	Drops	Description	Case quantity
ME1050		 <p>Minibore extension set, removable slide clamp, male spin lock</p> <p>Approximate set length: 30" 76 cm. approx.</p> <p>Approximate priming volume: 1 mL</p>	 50
ME1110		 <p>Minibore extension set, removable slide clamp, male spin lock</p> <p>Approximate set length: 36" 91 cm. approx.</p> <p>Approximate priming volume: 1.3 mL</p>	 50
ME1227		 <p>Minibore extension set, non-removable slide clamp, male spin lock</p> <p>Approximate set length: 6" 15 cm. approx.</p> <p>Approximate priming volume: 0.32 mL</p>	 50
ME1234		 <p>Minibore extension set, removable slide clamp, male spin lock</p> <p>Approximate set length: 6" 15 cm. approx.</p> <p>Approximate priming volume: 0.32 mL</p>	 300
ME1251		 <p>Minibore extension set, pinch clamp, male luer slip</p> <p>Approximate set length: 7" 18 cm. approx.</p> <p>Approximate priming volume: 0.3 mL</p>	 50
ME1253		 <p>Minibore tri-fuse extension set, 4 removable slide clamps, male spin lock</p> <p>Approximate set length: 12.25" 31 cm. approx.</p> <p>Approximate priming volume: 0.8 mL</p>	 50

30-day lead time

30-day lead time

05.00 Extension sets

05.03.04 Minibore/Smallbore tubing | No port sets

Extension sets provide flexibility and additional infusion capabilities to gravity and infusion instrument sets. All sets are latex free. Configurations are available with integrated MaxPlus and MaxGuard needleless connectors, SmartSite needle-free valves and VersaSafe split septum ports.

Model #	Drops	Description	Case quantity
ME2010		 <p>Minibore extension set, removable slide clamp, male spin lock</p> <p>Approximate set length: 60" 152.4 cm. approx.</p> <p>Approximate priming volume: 1.8 mL</p>	 50
ME2017		 <p>Ultra minibore extension set, pinch clamp, male luer lock</p> <p>Approximate set length: 60" 152.4 cm. approx.</p> <p>Approximate priming volume: 1 mL</p>	 50
ME2050		 <p>Minibore extension set, removable slide clamp, male luer lock</p> <p>Approximate set length: 60" 152 cm. approx.</p> <p>Approximate priming volume: 1.6 mL</p>	 50
10010525		 <p>Minibore/Smallbore extension set, anti-siphon valve, spin male luer lock</p> <p>Approximate set length: 31" 78 cm. approx.</p> <p>Approximate priming volume: 1.2 mL</p>	 100
30-day lead time			
10011881		 <p>Minibore/Smallbore extension set, luer slip adapter</p> <p>Approximate set length: 40" 102 cm. approx.</p> <p>Approximate priming volume: 1 mL</p>	 100
10015817		 <p>Minibore/Smallbore quadfuse extension set, 4 female luer locks, spin male luer lock</p> <p>Approximate set length: 7.5" 19 cm. approx.</p> <p>Approximate priming volume: 0.91 mL</p>	 100
30-day lead time			

05.00 Extension sets

05.03.04 Minibore/Smallbore tubing | No port sets

Extension sets provide flexibility and additional infusion capabilities to gravity and infusion instrument sets. All sets are latex free. Configurations are available with integrated MaxPlus and MaxGuard needleless connectors, SmartSite needle-free valves and VersaSafe split septum ports.

Model #	Drops	Description	Case quantity
10031776 30-day lead time		 <p>Minibore/Smallbore extension set, fixed male luer lock</p> <p>Approximate set length: 234" 594 cm. approx.</p> <p>Approximate priming volume: 13 mL</p>	 <p>50</p>
10373772		 <p>Minibore/Smallbore extension set, spin male luer lock</p> <p>Approximate set length: 6" 15 cm. approx.</p> <p>Approximate priming volume: 0.24 mL</p>	 <p>100</p>
10794983		 <p>Minibore/Smallbore extension set, 2 female luer locks, spin male luer lock</p> <p>Approximate set length: 7" 18 cm. approx.</p> <p>Approximate priming volume: 0.37 mL</p>	 <p>100</p>
10839681		 <p>Minibore/Smallbore extension set, 3 female luer locks, spin male luer lock</p> <p>Approximate set length: 7.5" 19 cm. approx.</p> <p>Approximate priming volume: 0.53 mL</p>	 <p>100</p>
10896354 30-day lead time		 <p>Minibore/Smallbore extension set, spin male luer lock</p> <p>Approximate set length: 110" 279 cm. approx.</p> <p>Approximate priming volume: 6 mL</p>	 <p>100</p>

05.00 Extension sets

05.03.04 Minibore/Smallbore tubing | No port sets







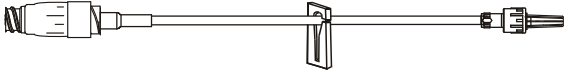

Extension sets provide flexibility and additional infusion capabilities to gravity and infusion instrument sets. All sets are latex free. Configurations are available with integrated MaxPlus and MaxGuard needleless connectors, SmartSite needle-free valves and VersaSafe split septum ports.

Model #	Drops	Description		Case quantity
11088483		 <p>Minibore/Smallbore extension set, fixed male luer lock</p> <p>Approximate set length: 62" 158 cm. approx.</p> <p>Approximate priming volume: 1.5 mL</p>		100
C20016		 <p>Minibore/Smallbore extension set, fixed male luer lock</p> <p>Approximate set length: 32" 81 cm. approx.</p> <p>Approximate priming volume: 1.9 mL</p>		72
C25012		 <p>Minibore/Smallbore extension set, detachable anti-siphon valve, fixed male luer lock</p> <p>Approximate set length: 5.5" 14 cm. approx.</p> <p>Approximate priming volume: 0.51 mL</p>		20
C30006		 <p>Minibore/Smallbore extension set, spin male luer lock</p> <p>Approximate set length: 62" 157 cm. approx.</p> <p>Approximate priming volume: 1.5 mL</p>		100

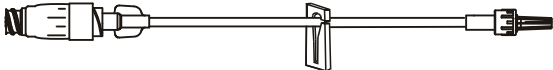
05.00 Extension sets

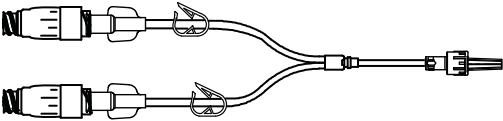
05.04.01 Microbore tubing | MaxPlus and MaxGuard needleless connector sets

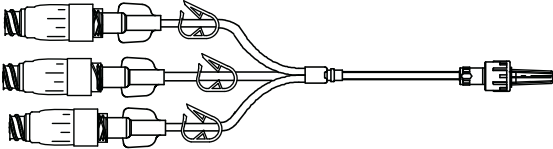
Extension sets provide flexibility and additional infusion capabilities to gravity and infusion instrument sets. All sets are latex free. Configurations are available with integrated MaxPlus and MaxGuard needleless connectors, SmartSite needle-free valves and VersaSafe split septum ports.

Model #	Drops	Description	Case quantity
MP9249-C		 <p>Microbore extension set, MaxPlus clear needleless connector, removable slide clamp, male spin lock</p> <p>Approximate set length: 62" 157 cm. approx.</p> <p>Approximate priming volume: 0.61 mL</p>	 50
MP9258-C		 <p>Microbore extension set, removable MaxPlus clear needleless connector, removable slide clamp, male luer lock</p> <p>Approximate set length: 6" 15 cm. approx.</p> <p>Approximate priming volume: 0.45 mL</p>	 50
MP9265-C		 <p>Microbore bi-fuse extension set, 2 removable MaxPlus clear needleless connectors, 2 pinch clamps, male spin lock</p> <p>Approximate set length: 6" 15 cm approx.</p> <p>Approximate priming volume: 0.8 mL</p>	 50
MP9266-C		 <p>Microbore tri-fuse extension set, 3 removable MaxPlus clear needleless connectors, 3 pinch clamps, male spin lock</p> <p>Approximate set length: 5" 13 cm approx.</p> <p>Approximate priming volume: 1.1 mL</p>	 50







Contact CareFusion for lead time

Contact CareFusion for lead time

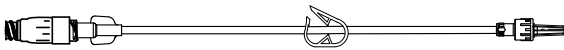
05.00 Extension sets

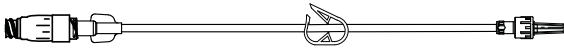
05.04.01 Microbore tubing | MaxPlus and MaxGuard needleless connector sets

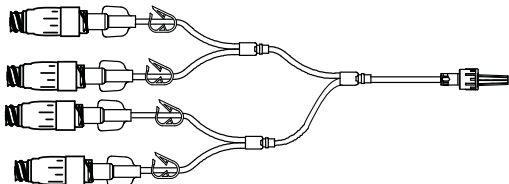







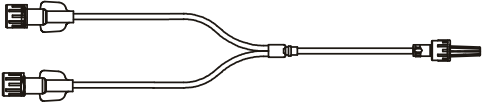

Extension sets provide flexibility and additional infusion capabilities to gravity and infusion instrument sets. All sets are latex free. Configurations are available with integrated MaxPlus and MaxGuard needleless connectors, SmartSite needle-free valves and VersaSafe split septum ports.

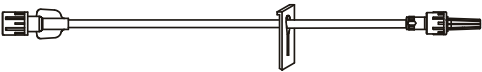
Model #	Drops	Description	Case quantity
MP9267-C Contact CareFusion for lead time		 <p>Microbore extension set, removable MaxPlus clear needleless connector, pinch clamp, male spin lock</p> <p>Approximate set length: 60" 152 cm approx.</p> <p>Approximate priming volume: 0.7 mL</p>	 50
MP9268-C Contact CareFusion for lead time		 <p>Microbore extension set, removable MaxPlus clear needleless connector, pinch clamp, male spin lock</p> <p>Approximate set length: 8" 20 cm approx.</p> <p>Approximate priming volume: 0.4 mL</p>	 50
MP9275-C Contact CareFusion for lead time		 <p>Microbore quad-fuse extension set, 4 removable MaxPlus clear needleless connectors, 4 pinch clamps, male spin lock</p> <p>Approximate set length: 6" 15 cm approx.</p> <p>Approximate priming volume: 1.6 mL</p>	 50

05.00 Extension sets

05.04.02 Microbore tubing | No port sets









Extension sets provide flexibility and additional infusion capabilities to gravity and infusion instrument sets. All sets are latex free. Configurations are available with integrated MaxPlus and MaxGuard needleless connectors, SmartSite needle-free valves and VersaSafe split septum ports.

Model #	Drops	Description	Case quantity
ME1222 30-day lead time		 <p>Microbore bi-fuse extension set, male spin lock</p> <p>Approximate set length: 4" 10 cm. approx.</p> <p>Approximate priming volume: 0.2 mL</p>	 50
ME2020		 <p>Microbore extension set, non-removable slide clamp, male spin lock</p> <p>Approximate set length: 60" 152 cm. approx.</p> <p>Approximate priming volume: 0.3 mL</p>	 50
ME2059		 <p>Microbore extension set, male spin lock</p> <p>Approximate set length: 72" 183 cm. approx.</p> <p>Approximate priming volume: 0.4 mL</p>	 50
20022		 <p>Microbore extension set, spin male luer.</p> <p>Approximate set length: 62" 158 cm. approx.</p> <p>Approximate priming volume: 0.57 mL</p>	 100
30822		 <p>Microbore extension set, fixed male luer lock</p> <p>Approximate set length: 62" 157 cm. approx.</p> <p>Approximate priming volume: 0.58 mL</p>	 50

05.00 Extension sets

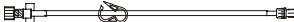
05.04.02 Microbore tubing | No port sets

Extension sets provide flexibility and additional infusion capabilities to gravity and infusion instrument sets. All sets are latex free. Configurations are available with integrated MaxPlus and MaxGuard needleless connectors, SmartSite needle-free valves and VersaSafe split septum ports.





Model #	Drops	Description	Case quantity
30862-0500		 <p>Microbore extension set, anti-siphon valve, fixed male luer lock</p> <p>Approximate set length: 62" 157 cm. approx.</p> <p>Approximate priming volume: 0.67 mL</p>	50
30910		 <p>Microbore extension set, fixed male luer lock</p> <p>Approximate set length: 38" 97 cm. approx.</p> <p>Approximate priming volume: 0.37 mL</p>	 100
30914		 <p>Microbore extension set, fixed male luer lock</p> <p>Approximate set length: 62" 156 cm. approx.</p> <p>Approximate priming volume: 0.57 mL</p>	 100
C20032		 <p>Microbore extension set, fixed male luer lock</p> <p>Approximate set length: 7.5" 19 cm. approx.</p> <p>Approximate priming volume: 0.23 mL</p>	 100
C25006		 <p>Microbore extension set, fixed male luer lock</p> <p>Approximate set length: 84" 213 cm. approx.</p> <p>Approximate priming volume: 0.75 mL</p>	 100

06.00 Alaris Pump module

06.01.01 Stopcocks and manifolds | SmartSite valve sets

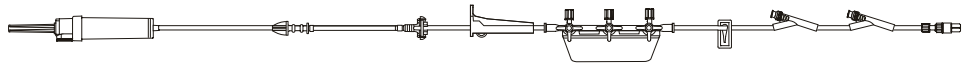
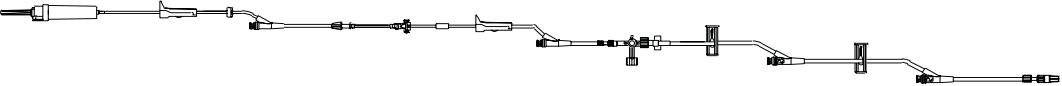
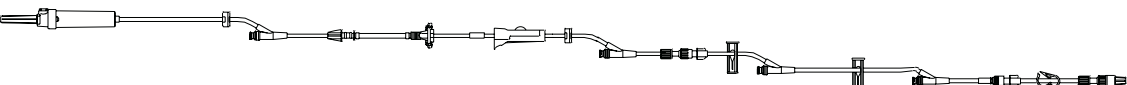
Administration sets for use with the Alaris Pump module. All sets are latex free and contain an integrated safety clamp fitment to help prevent accidental free flow. Configurations are available with integrated SmartSite needle-free valves and VersaSafe split septum ports.

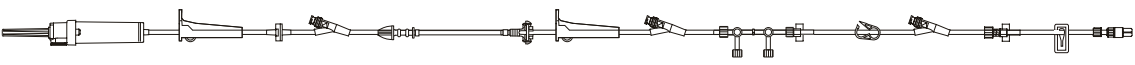



Model #	Drops	Description	Case quantity
2406-0500	20	 <p>Infusion set, smallbore tubing segment, 3-port manifold, 2 needle-free valves 54" and 7" from 2-piece male luer lock</p> <p>Approximate set length: 112" 284 cm. approx.</p> <p>Approximate priming volume: 18 mL</p>	20
2408-0500	10	 <p>Infusion set, check valve, 4-way stopcock ("OFF" Indicator), 4 needle-free valves 105", 37", 24" and 6" from 2-piece male luer lock</p> <p>Approximate set length: 124" 315 cm. approx.</p> <p>Approximate priming volume: 25 mL</p>	10
2428-0007	20	 <p>Infusion set, 2 check valves, 4 needle-free valves 98", 50", 41" and 10" from 2-piece male luer lock</p> <p>Approximate set length: 127" 322 cm. approx.</p> <p>Approximate priming volume: 27 mL</p>	 20
2450-0500	10	 <p>Infusion set, check valve, 2-ganged 3-way stopcock, 3 needle-free valves 108", 45" and 12" from 2-piece male luer lock</p> <p>Approximate set length: 129" 327 cm. approx.</p> <p>Approximate priming volume: 27 mL</p>	 10

06.00 Alaris Pump module

06.01.01 Stopcocks and manifolds | SmartSite valve sets

Administration sets for use with the Alaris Pump module. All sets are latex free and contain an integrated safety clamp fitment to help prevent accidental free flow. Configurations are available with integrated SmartSite needle-free valves and VersaSafe split septum ports.

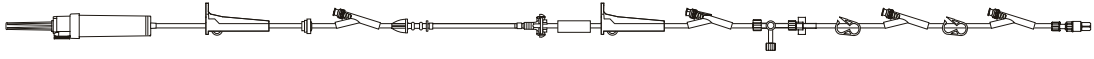

Model #	Drops	Description	Case quantity
10012182	10	 <p>Infusion set, check valve, 4-way stopcock ("OFF" Indicator), 4 needle-free valves 124", 46", 32" and 7" from 2-piece male luer lock</p> <p>Approximate set length: 160" 406 cm. approx.</p> <p>Approximate priming volume: 30 mL</p>	10
10013034	20	 <p>Infusion set, check valve, 2-ganged 4-way stopcock, 3 needle-free valves 91", 73" and 8" from 2-piece male luer lock</p> <p>Approximate set length: 128" 325 cm. approx.</p> <p>Approximate priming volume: 27 mL</p>	20
10015312	20	 <p>Infusion set, check valve, 2-ganged 3-way stopcock, 3 needle-free valves 99", 79" and 6" from 2-piece male luer lock</p> <p>Approximate set length: 134" 340 cm. approx.</p> <p>Approximate priming volume: 28 mL</p>	10
10015649	20	 <p>Infusion set, check valve, 4-way stopcock ("OFF" Indicator), 3 needle-free valves 112", 40" and 5" from 2-piece fixed male luer lock</p> <p>Approximate set length: 129" 328 cm. approx.</p> <p>Approximate priming volume: 27 mL</p>	20



06.00 Alaris Pump module

06.01.01 Stopcocks and manifolds | SmartSite valve sets

Administration sets for use with the Alaris Pump module. All sets are latex free and contain an integrated safety clamp fitment to help prevent accidental free flow. Configurations are available with integrated SmartSite needle-free valves and VersaSafe split septum ports.



Model #	Drops	Description	Case quantity
---------	-------	-------------	---------------

10015896	10	 <p>Infusion set, check valve, 2 needle-free valves 73" and 6" from 2-piece male luer lock Extension set, 2-ganged 4-way stopcock, 1 needle-free valve 6" from 2-piece male luer lock</p>	 10
		<p>Approximate set length: 125" 318 cm. approx. Approximate priming volume: 25 mL</p>	

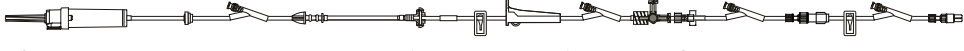
10108961	20	 <p>Infusion set, check valve, 4-way stopcock ("OFF" Indicator), 4 needle-free valves 98", 38", 27" and 4" from 2-piece male luer lock</p>	20
		<p>Approximate set length: 126" 320 cm. approx. Approximate priming volume: 26 mL</p>	

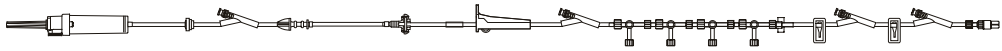
10142568	20	 <p>Infusion set, check valve, 4-ganged 4-way stopcock, 4 needle-free valves 107", 49", 32" and 7" from spin male luer lock</p>	20
		<p>Approximate set length: 135" 343 cm. approx. Approximate priming volume: 28 mL</p>	

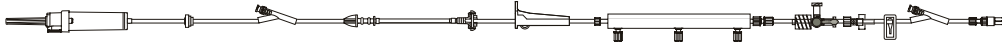



10382963	20	 <p>Infusion set, check valve, manifold with three 1-way valves, 3-way stopcock, 2 needle-free valves 116" and 6" from 2-piece male luer lock</p>	20
		<p>Approximate set length: 139" 353 cm. approx. Approximate priming volume: 29 mL</p>	

06.00 Alaris Pump module

06.01.01 Stopcocks and manifolds | SmartSite valve sets

Administration sets for use with the Alaris Pump module. All sets are latex free and contain an integrated safety clamp fitment to help prevent accidental free flow. Configurations are available with integrated SmartSite needle-free valves and VersaSafe split septum ports.

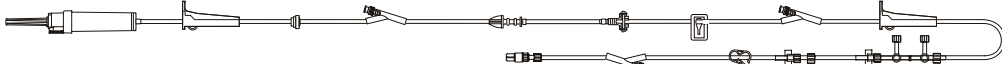
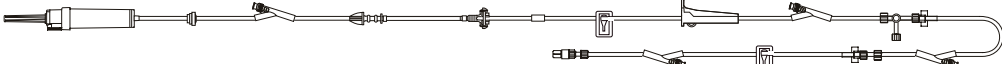
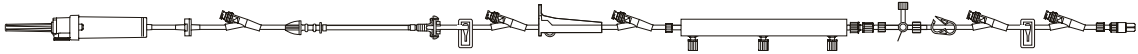

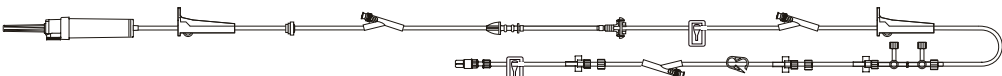

Model #	Drops	Description	Case quantity
10813621	20	 <p>Infusion set, check valve, 3-ganged 4-way stopcock, 4 needle-free valves 68", 28", 12" and 6" from 2-piece male luer lock</p> <p>Approximate set length: 159" 404 cm. approx. Approximate priming volume: 30 mL</p>	 20
10934345	20	 <p>Infusion set, check valve, 2-ganged 3-way stopcock, 3 needle-free valves 109", 90" and 8" from 2-piece male luer lock</p> <p>Approximate set length: 140" 357 cm. approx. Approximate priming volume: 28 mL</p>	10
11059729	20	 <p>Infusion set, check valve, 4-way stopcock ("OFF" Indicator), 4 needle-free valves 115", 47", 32" and 6" from 2-piece male luer lock</p> <p>Approximate set length: 130" 330 cm. approx. Approximate priming volume: 27 mL</p>	20
11419365	20	 <p>Infusion set, check valve, manifold with three 1-way valves, 3-way stopcock, 5 needle-free valves 120", 101", 47", 25" and 6" from 2-piece male luer lock</p> <p>Approximate set length: 159" 404 cm. approx. Approximate priming volume: 32 mL</p>	 20
11582773	20	 <p>Infusion set, check valve, 2-ganged 3-way stopcock, 3 needle-free valves 87", 68" and 15" from 2-piece male luer lock</p> <p>Approximate set length: 148" 376 cm. approx. Approximate priming volume: 30 mL</p>	10

06.00 Alaris Pump module

06.01.01 Stopcocks and manifolds | SmartSite valve sets

Administration sets for use with the Alaris Pump module. All sets are latex free and contain an integrated safety clamp fitment to help prevent accidental free flow. Configurations are available with integrated SmartSite needle-free valves and VersaSafe split septum ports.

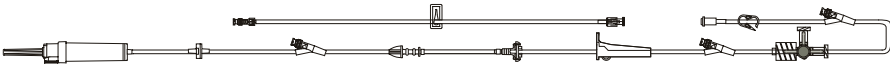
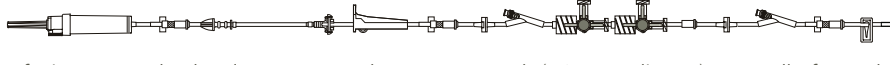

Model #	Drops	Description	Case quantity
C24104E	20	 <p>Infusion set, check valve, 4-way stopcock ("OFF" Indicator), 3 needle-free valves 121", 42" and 6" from 2-piece male luer lock Smallbore extension set, 1 needle-free valve, fixed male luer lock</p> <p>Approximate set length: 161" 409 cm. approx.</p> <p>Approximate priming volume: 31 mL</p>	10
C24106E	20	 <p>Infusion set, 2 check valves, 2-ganged 4-way stopcock ("OFF" Indicator), 2 needle-free valves 26" and 2" from 2-piece male luer lock hub. Smallbore extension set, needle-free valve T-connector, spin male luer lock hub</p> <p>Approximate set length: 96" 244 cm. approx.</p> <p>Approximate priming volume: 21 mL</p>	10
C24107E	60	 <p>Infusion set, 2 check valves, 2-ganged 4-way stopcock ("OFF" Indicator), 2 needle-free valves 26" and 2" from 2-piece male luer lock hub. Smallbore extension set, needle-free valve T-connector, spin male luer lock hub</p> <p>Approximate set length: 96" 244 cm. approx.</p> <p>Approximate priming volume: 22 mL</p>	10

30-day lead time



30-day lead time

06.00 Alaris Pump module

06.01.02 Stopcocks and manifolds | VersaSafe split septum sets

Administration sets for use with the Alaris Pump module. All sets are latex free and contain an integrated safety clamp fitment to help prevent accidental free flow. Configurations are available with integrated SmartSite needle-free valves and VersaSafe split septum ports.

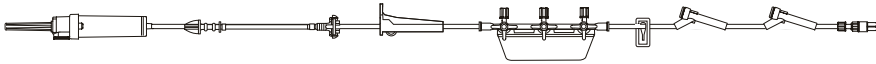





Model #	Drops	Description	Case quantity
2106-0500	20	 <p>Infusion set, 3-port manifold, smallbore tubing segment, 2 split septum ports 54" and 7" from 2-piece male luer lock</p> <p>Approximate set length: 112" 286 cm. approx.</p> <p>Approximate priming volume: 19 mL</p>	20
11147992	20	 <p>Infusion set, smallbore tubing segment, manifold with three 1-way valves, 2 split septum ports 54" and 7" from 2-piece male luer lock</p> <p>Approximate set length: 113" 287 cm. approx.</p> <p>Approximate priming volume: 20 mL</p>	20

06.00 Alaris Pump module

06.02.01 Burettes | SmartSite valve sets

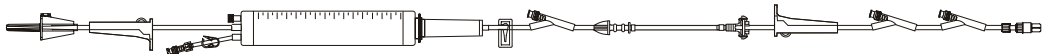
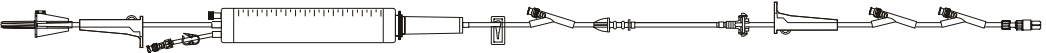
Administration sets for use with the Alaris Pump module. All sets are latex free and contain an integrated safety clamp fitment to help prevent accidental free flow. Configurations are available with integrated SmartSite needle-free valves and VersaSafe split septum ports.

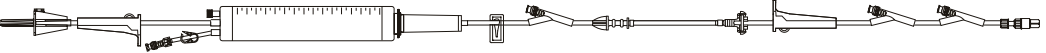
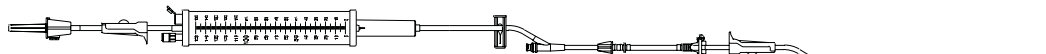

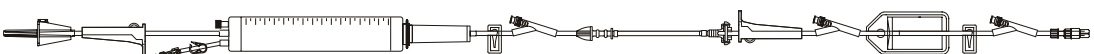
Model #	Drops	Description	Case quantity
2440-0600	20	 <p>Infusion set, 150 mL burette (needle-free valve), 3 needle-free valves 85", 60" and 6" from 2-piece male luer lock</p> <p>Approximate set length: 126" 320 cm. approx.</p> <p>Approximate priming volume: 28 mL</p>	10
2441-0007	60	 <p>Infusion set, 150 mL burette (needle-free valve), smallbore tubing segment, 3 needle-free valves 86", 49" and 7" from 2-piece male luer lock</p> <p>Approximate set length: 130" 330 cm. approx.</p> <p>Approximate priming volume: 21 mL</p>	10 
2441-0600	60	 <p>Infusion set, 150 mL burette (needle-free valve), smallbore tubing segment, 3 needle-free valves 86", 60" and 7" from 2-piece male luer lock</p> <p>Approximate set length: 132" 335 cm. approx.</p> <p>Approximate priming volume: 21 mL</p>	10
2442-0007	60	 <p>Infusion set, 150 mL burette (split septum port), smallbore tubing segment, 3 needle-free valves 86", 49", and 7" from 2-piece male luer lock</p> <p>Approximate set length: 130" 329 cm. approx.</p> <p>Approximate priming volume: 21 mL</p>	10 
2443-0600	60	 <p>Infusion set, 150 mL burette (needle-free valve), smallbore tubing segment, 0.2 micron (low-protein binding) filter, 3 needle-free valves 81", 55" and 6" from 2-piece male luer lock</p> <p>Approximate set length: 132" 335 cm. approx.</p> <p>Approximate priming volume: 24 mL</p>	10



06.00 Alaris Pump module

06.02.01 Burettes | SmartSite valve sets

Administration sets for use with the Alaris Pump module. All sets are latex free and contain an integrated safety clamp fitment to help prevent accidental free flow. Configurations are available with integrated SmartSite needle-free valves and VersaSafe split septum ports.

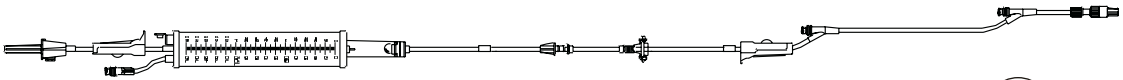

Model #	Drops	Description	Case quantity
---------	-------	-------------	---------------

2447-0007    10

Infusion set, 150 mL burette (needle-free valve), ball valve in drip chamber, 2 needle-free valves 60" and 7" from 2-piece male luer lock

Approximate set length: 129" 328 cm. approx.

Approximate priming volume: 24 mL

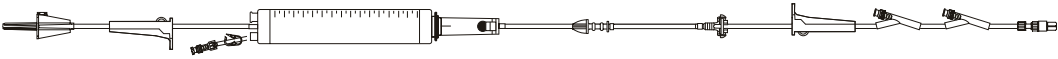
2447-0600   10

Infusion set, 150 mL burette (needle-free valve), ball valve in drip chamber, smallbore tubing segment, 2 needle-free valves 60" and 7" from 2-piece male luer lock

Approximate set length: 131" 333 cm. approx.

Approximate priming volume: 19 mL

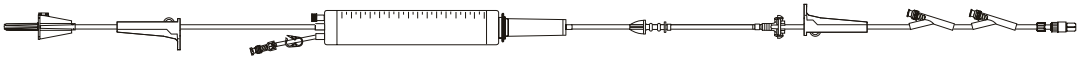
2448-0600   10

30-day lead time

Infusion set, 150 mL burette (needle-free valve), 2 needle-free valves 60" and 6" from 2-piece male luer lock

Approximate set length: 126" 320 cm. approx.

Approximate priming volume: 30 mL

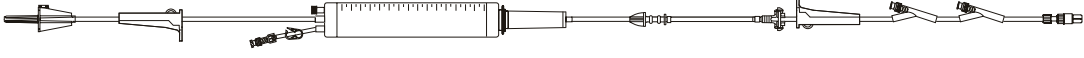
2449-0600   10

Infusion set, 150 mL burette (needle-free valve), smallbore tubing segment, 2 needle-free valves 60" and 7" from 2-piece male luer lock

Approximate set length: 131" 333 cm. approx.

Approximate priming volume: 20 mL

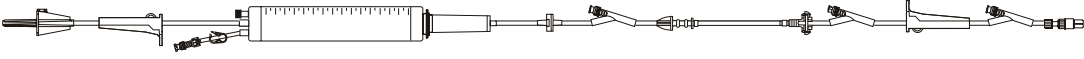
10010541   10

Infusion set, 150 mL burette (needle-free valve), check valve, 3 needle-free valves 82", 66" and 6" from 2-piece male luer lock

Approximate set length: 125" 318 cm. approx.

Approximate priming volume: 29 mL

06.00 Alaris Pump module

06.02.01 Burettes | SmartSite valve sets

Administration sets for use with the Alaris Pump module. All sets are latex free and contain an integrated safety clamp fitment to help prevent accidental free flow. Configurations are available with integrated SmartSite needle-free valves and VersaSafe split septum ports.



Model #	Drops	Description	Case quantity
---------	-------	-------------	---------------

10010871

20

30-day lead time

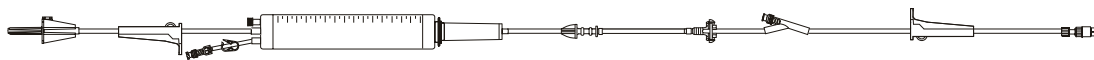

Infusion set, 150 mL burette (needle-free valve), low sorbing tubing segment, 1 needle-free valve 12" from 2-piece male luer lock (Gamma Radiation sterilization) 10

Approximate set length: 69" 175 cm. approx.

Approximate priming volume: 16 mL

10012283

60



Infusion set, 150 mL burette (needle-free valve), ball valve in drip chamber, 0.2 micron (low-protein binding) filter, 2 needle-free valves 52" and 7" from 2-piece male luer lock 10

Approximate set length: 129" 328 cm. approx.

Approximate priming volume: 27 mL

10012293

60

30-day lead time

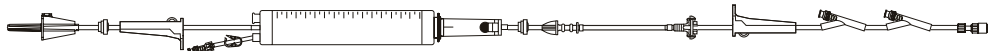

Infusion set, 150 mL burette (needle-free valve), ball valve in drip chamber, smallbore tubing segment, 2 check valves, 2 needle-free valves 64" and 8" from 2-piece male luer lock 10

Approximate set length: 137" 348 cm. approx.

Approximate priming volume: 20 mL

10014035

60

30-day lead time



Infusion set, 150 mL burette (needle-free valve), smallbore tubing segment, check valve, 3 needle-free valves 84", 60" and 7" from 2-piece male luer lock 10

Approximate set length: 132" 335 cm. approx.







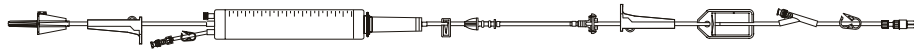

Approximate priming volume: 21 mL

06.00 Alaris Pump module

06.02.01 Burettes | SmartSite valve sets

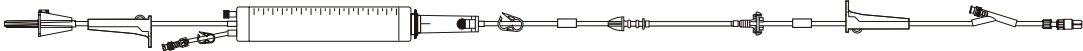
Administration sets for use with the Alaris Pump module. All sets are latex free and contain an integrated safety clamp fitment to help prevent accidental free flow. Configurations are available with integrated SmartSite needle-free valves and VersaSafe split septum ports.



Model #	Drops	Description	Case quantity
10015012	20	 <p>Infusion set, 150 mL burette (needle-free valve), low sorbing and smallbore tubing segments, 0.2 micron (low-protein binding) filter, 1 needle-free valve 6" from 2-piece male luer lock</p> <p>Approximate set length: 125" 318 cm. approx. Approximate priming volume: 26 mL</p>	 10
10074281	20	 <p>Low sorbing infusion set, 150 mL burette (needle-free valve), 1 needle-free valve 32" from 2-piece male luer lock</p> <p>Approximate set length: 130" 330 cm. approx. Approximate priming volume: 26 mL</p>	 20
10817920	60	 <p>Infusion set, 150 mL burette (needle-free valve), ball valve in drip chamber, smallbore tubing segment, 1 needle-free valve 7" from 2-piece male luer lock</p> <p>Approximate set length: 123" 312 cm. approx. Approximate priming volume: 19 mL</p>	 10
10821753	20	 <p>Infusion set, 150 mL burette (needle-free valve), low sorbing tubing segment, 3 needle-free valves 24", 18" and 6" from 2-piece male luer lock</p> <p>Approximate set length: 126" 320 cm. approx. Approximate priming volume: 25 mL</p>	 10

06.00 Alaris Pump module

06.02.01 Burettes | SmartSite valve sets

Administration sets for use with the Alaris Pump module. All sets are latex free and contain an integrated safety clamp fitment to help prevent accidental free flow. Configurations are available with integrated SmartSite needle-free valves and VersaSafe split septum ports.



Model #	Drops	Description	Case quantity
---------	-------	-------------	---------------

11118122

60

30-day lead time



Infusion set, 150 mL burette (needle-free valve), 0.2 micron (low-protein binding) filter, 3 needle-free valves 89", 62" and 6" from 2-piece male luer lock



10

Approximate set length: 129" 328 cm. approx.
 Approximate priming volume: 28 mL

11607787

60

30-day lead time

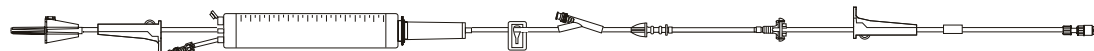

Infusion set, 150 mL burette set (needle-free valve), smallbore tubing segment, 1 needle-free valve 86" from 2-piece male luer lock



10

Approximate set length: 129" 328 cm. approx.
 Approximate priming volume: 21 mL

11613191

60

30-day lead time



Infusion set, 150 mL burette (needle-free valve), ball valve in drip chamber, low sorbing tubing segment, 0.2 micron (low-protein binding) filter, 2 needle-free valves 51" and 7" from 2-piece male luer lock



10





Approximate set length: 130" 330 cm. approx.
 Approximate priming volume: 27 mL

06.00 Alaris Pump module

06.02.02 Burettes | No port sets

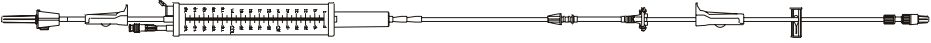
Administration sets for use with the Alaris Pump module. All sets are latex free and contain an integrated safety clamp fitment to help prevent accidental free flow. Configurations are available with integrated SmartSite needle-free valves and VersaSafe split septum ports.



Model #	Drops	Description	Case quantity
2444-0007 30-day lead time	20	 Low sorbing infusion set, burette (needle-free valve), 2-piece male luer lock Approximate set length: 123" 312 cm. approx. Approximate priming volume: 24 mL	 10
11045328	20	 Infusion set, 150 mL burette (needle-free valve), 0.2 micron (low-protein binding) filter, 2-piece male luer lock Approximate set length: 123" 312 cm. approx. Approximate priming volume: 30 mL	10
11063735	20	 Infusion set, 150 mL burette (needle-free valve), 2-piece male luer lock Approximate set length: 125" 318 cm. approx. Approximate priming volume: 28 mL	10

06.00 Alaris Pump module

06.02.03 Burettes | VersaSafe split septum sets

Administration sets for use with the Alaris Pump module. All sets are latex free and contain an integrated safety clamp fitment to help prevent accidental free flow. Configurations are available with integrated SmartSite needle-free valves and VersaSafe split septum ports.



Model #	Drops	Description	Case quantity
---------	-------	-------------	---------------

2140-0600

20

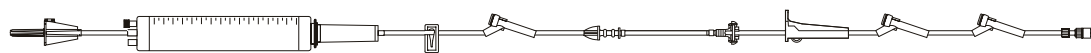

Infusion set, 150 mL burette (split septum port), 3 split septum ports
82", 56" and 6" from 2-piece male luer lock

10

Approximate set length: 126" 320 cm. approx.

Approximate priming volume: 28 mL

2141-0600

60

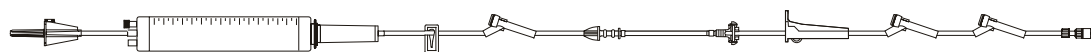

Infusion set, 150 mL burette (split septum port), smallbore tubing segment,
3 split septum ports 86", 60" and 7" from 2-piece male luer lock

10

Approximate set length: 132" 335 cm. approx.

Approximate priming volume: 21 mL

2147-0600

60

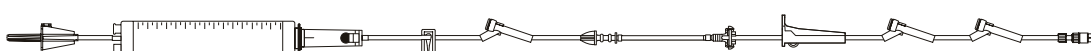

Infusion set, 150 mL burette (split septum port), ball valve in drip chamber, smallbore
tubing segment, 3 split septum ports 86", 60" and 7" from 2-piece male luer lock

10

Approximate set length: 132" 335 cm. approx.

Approximate priming volume: 20 mL

30-day lead time

2442-0007

60

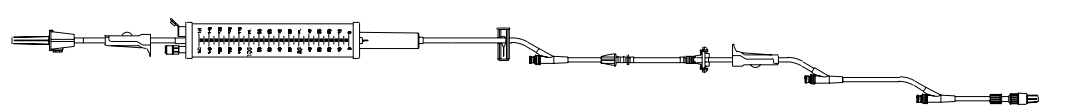

Infusion set, 150 mL burette (split septum port), smallbore tubing segment,
3 needle-free valves 86", 49", and 7" from 2-piece male luer lock

10

Approximate set length: 130" 329 cm. approx.

Approximate priming volume: 21 mL







06.00 Alaris Pump module

06.02.03 Burettes | VersaSafe split septum sets

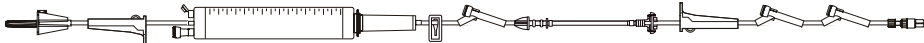
Administration sets for use with the Alaris Pump module. All sets are latex free and contain an integrated safety clamp fitment to help prevent accidental free flow. Configurations are available with integrated SmartSite needle-free valves and VersaSafe split septum ports.





Model #	Drops	Description	Case quantity
10779313		 <p data-bbox="321 554 1154 621">Infusion set, 150 mL burette (split septum port), 3 split septum ports 81", 55" and 6" from 2-piece male luer lock</p> <p data-bbox="321 638 1003 665">Approximate set length: 125" 317 cm. approx.</p> <p data-bbox="321 678 724 705">Approximate priming volume: 25 mL</p>	 10
11401542		 <p data-bbox="321 848 1049 915">Infusion set, 150 mL burette (split septum port), smallbore tubing segment, 3 split septum ports 81", 62" and 8" from 2-piece male luer lock</p> <p data-bbox="321 932 1003 959">Approximate set length: 135" 343 cm. approx.</p> <p data-bbox="321 972 724 999">Approximate priming volume: 19 mL</p>	20

06.00 Alaris Pump module

06.03.01 Low sorbing tubing | SmartSite valve sets

Administration sets for use with the Alaris Pump module. All sets are latex free and contain an integrated safety clamp fitment to help prevent accidental free flow. Configurations are available with integrated SmartSite needle-free valves and VersaSafe split septum ports.

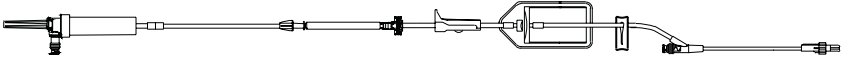

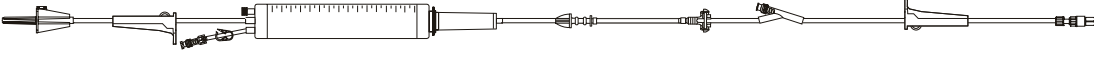





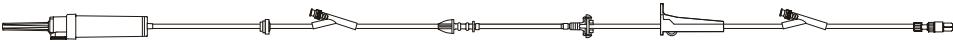

Model #	Drops	Description	Case quantity
2463-0007 30-day lead time	20	 Low sorbing infusion set, 1 needle-free valve 78" from 2-piece male luer lock Approximate set length: 119" 302 cm. approx. Approximate priming volume: 24 mL	DEHP 20
2465-0007	20	 Low sorbing infusion set, non-vented, needle-free bag access port, 20 drop, 0.2 micron (low protein binding) filter, 1 needle-free valve 6" from 2-piece male luer lock Approximate set length: 116" 293 cm. approx. Approximate priming volume: 26 mL	DEHP 20
10010453	20	 Low sorbing infusion set, 1.2 micron (low-protein binding) filter, 1 needle-free valve 6" from 2-piece male luer lock Approximate set length: 115" 291 cm. approx. Approximate priming volume: 26 mL	DEHP 20
10010454	20	 Low sorbing infusion set, 0.2 micron (low-protein binding) filter, 1 needle-free valve 6" from 2-piece male luer lock Approximate set length: 115" 291 cm. approx. Approximate priming volume: 26 mL	DEHP 20
10010871 30-day lead time	20	 Infusion set, 150 mL burette (needle-free valve), low sorbing tubing segment, 1 needle-free valve 12" from 2-piece male luer lock (Gamma Radiation sterilization) Approximate set length: 69" 175 cm. approx. Approximate priming volume: 16 mL	10

06.00 Alaris Pump module

06.03.01 Low sorbing tubing | SmartSite valve sets

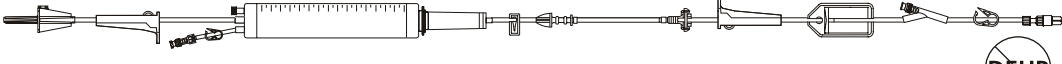
Administration sets for use with the Alaris Pump module. All sets are latex free and contain an integrated safety clamp fitment to help prevent accidental free flow. Configurations are available with integrated SmartSite needle-free valves and VersaSafe split septum ports.









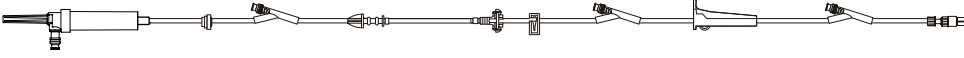

Model #	Drops	Description	Case quantity
10013072	20	 <p>Low sorbing infusion set, check valve, 2 needle-free valves 78" and 6" from 2-piece male luer lock</p> <p>Approximate set length: 103" 262 cm. approx.</p> <p>Approximate priming volume: 22 mL</p>	 20
10013889	20	 <p>Infusion set, low sorbing tubing segment, check valve, 3 needle-free valves 103", 78" and 6" from 2-piece male luer lock</p> <p>Approximate set length: 138" 350 cm. approx.</p> <p>Approximate priming volume: 28 mL</p>	20
10014855	20	 <p>Low sorbing infusion set, non-vented, needle-free valve bag access port, check valve, 2 needle-free valves 95" and 6" from 2-piece male luer lock</p> <p>Approximate set length: 116" 295 cm. approx.</p> <p>Approximate priming volume: 24 mL</p>	 20
10015012	20	 <p>Infusion set, 150 mL burette (needle-free valve), low sorbing and smallbore tubing segments, 0.2 micron (low-protein binding) filter, 1 needle-free valve 6" from 2-piece male luer lock</p> <p>Approximate set length: 125" 318 cm. approx.</p> <p>Approximate priming volume: 26 mL</p>	 10
10015048	20	 <p>Low sorbing infusion set, check valve, 2 needle-free valves 78" and 6" from 2-piece male luer lock</p> <p>Approximate set length: 103" 262 cm. approx.</p> <p>Approximate priming volume: 22 mL</p>	 20

06.00 Alaris Pump module

06.03.01 Low sorbing tubing | SmartSite valve sets

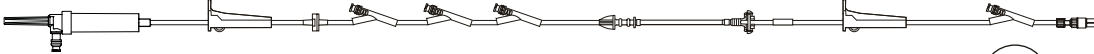
Administration sets for use with the Alaris Pump module. All sets are latex free and contain an integrated safety clamp fitment to help prevent accidental free flow. Configurations are available with integrated SmartSite needle-free valves and VersaSafe split septum ports.



Model #	Drops	Description	Case quantity
10015861 30-day lead time	20	 Low sorbing infusion set, non-vented, needle-free valve bag access port, check valve, 3 needle-free valves 95", 75" and 6" from 2-piece male luer lock Approximate set length: 128" 325 cm. approx. Approximate priming volume: 26 mL	 20
10015862	20	 Low sorbing infusion set, non-vented, needle-free valve bag access port, 2-piece male luer lock Approximate set length: 44" 112 cm. approx. Approximate priming volume: 14 mL	 20
10061661 30-day lead time	20	 Low sorbing infusion set, non-vented, needle-free valve bag access port, check valve, 4 needle-free valves 94", 92", 90" and 6" from 2-piece male luer lock Approximate set length: 121" 307 cm. approx. Approximate priming volume: 25 mL	 20
10074281 30-day lead time	20	 Low sorbing infusion set, 150 mL burette (needle-free valve), 1 needle-free valve 32" from 2-piece male luer lock Approximate set length: 130" 330 cm. approx. Approximate priming volume: 26 mL	 20
10137405	20	 Infusion set, low sorbing tubing segment, check valve, 3 needle-free valves 85", 67" and 6" from 2-piece male luer lock Approximate set length: 119" 302 cm. approx. Approximate priming volume: 25 mL	20

06.00 Alaris Pump module

06.03.01 Low sorbing tubing | SmartSite valve sets

Administration sets for use with the Alaris Pump module. All sets are latex free and contain an integrated safety clamp fitment to help prevent accidental free flow. Configurations are available with integrated SmartSite needle-free valves and VersaSafe split septum ports.



Model #	Drops	Description	Case quantity
---------	-------	-------------	---------------

10406194



30-day lead time

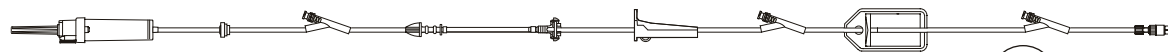

Infusion set, low sorbing and smallbore tubing segments, check valve, 0.2 micron (low-protein binding) filter, 3 needle-free valves 66", 46" and 6" from 2-piece male luer lock



10

Approximate set length: 154" 391 cm. approx.

Approximate priming volume: 28 mL

10821753



Infusion set, 150 mL burette (needle-free valve), low sorbing tubing segment, 3 needle-free valves 24", 18" and 6" from 2-piece male luer lock



10

Approximate set length: 126" 320 cm. approx.

Approximate priming volume: 25 mL

11532269



Low sorbing infusion set, check valve, 0.2 micron (low-protein binding) filter, 2 needle-free valves 87" and 6" from 2-piece male luer lock



20

Approximate set length: 124" 315 cm. approx.

Approximate priming volume: 28 mL

11609481



30-day lead time

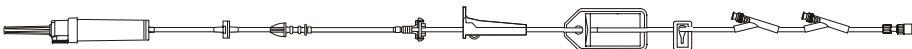

Low sorbing infusion set, check valve, 0.2 micron (low-protein binding) filter, 2 needle-free valves 12" and 6" from 2-piece male luer lock



20

Approximate set length: 124" 315 cm. approx.







Approximate priming volume: 28 mL

06.00 Alaris Pump module

06.03.01 Low sorbing tubing | SmartSite valve sets

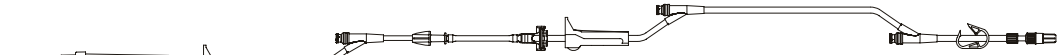
Administration sets for use with the Alaris Pump module. All sets are latex free and contain an integrated safety clamp fitment to help prevent accidental free flow. Configurations are available with integrated SmartSite needle-free valves and VersaSafe split septum ports.

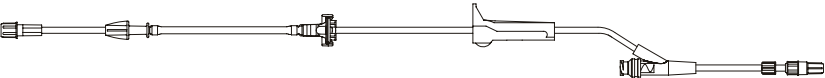











Model #	Drops	Description	Case quantity
11613191 30-day lead time	60	 <p>Infusion set, 150 mL burette (needle-free valve), ball valve in drip chamber, low sorbing tubing segment, 0.2 micron (low-protein binding) filter, 2 needle-free valves 51" and 7" from 2-piece male luer lock</p> <p>Approximate set length: 130" 330 cm. approx. Approximate priming volume: 27 mL</p>	 10
2461-0007	20	 <p>Infusion set, low sorbing tubing segments, check valve, 3 needle-free valves 96", 66" and 6" from 2-piece male luer lock</p> <p>Approximate set length: 137" 348 cm. approx. Approximate priming volume: 27 mL</p>	 20
2462-0007 30-day lead time	20	 <p>Low sorbing half set, 1 needle-free valve, 6" from from 2-piece male luer lock</p> <p>Approximate set length: 93" 236 cm. approx. Approximate priming volume: 13 mL</p>	 20

06.00 Alaris Pump module

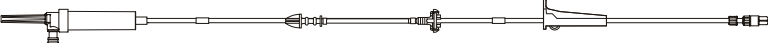
06.03.02 Low sorbing tubing | No port sets

Administration sets for use with the Alaris Pump module. All sets are latex free and contain an integrated safety clamp fitment to help prevent accidental free flow. Configurations are available with integrated SmartSite needle-free valves and VersaSafe split septum ports.









Model #	Drops	Description	Case quantity
2260-0500	20	 <p>Low sorbing infusion set, 2-piece male luer lock</p> <p>Approximate set length: 113" 287 cm. approx.</p> <p>Approximate priming volume: 23 mL</p>	 20
2444-0007	20	 <p>Low sorbing infusion set, burette (needle-free valve), 2-piece male luer lock</p> <p>Approximate set length: 123" 312 cm. approx.</p> <p>Approximate priming volume: 24 mL</p>	 10
2466-0007	20	 <p>Low sorbing infusion set, non-vented, needle-free bag access port, spin male luer lock</p> <p>Approximate set length: 86" 219 cm. approx.</p> <p>Approximate priming volume: 20 mL</p>	 20
10013854	20	 <p>Low sorbing infusion set, non-vented, 15 micron filter, needle-free valve bag access port, luer lock connector</p> <p>Approximate set length: 113" 287 cm. approx.</p> <p>Approximate priming volume: 20 mL</p>	 20
10013890	20	 <p>Low sorbing infusion set, 2-piece male luer lock</p> <p>Approximate set length: 44" 112 cm. approx.</p> <p>Approximate priming volume: 13 mL</p>	 20

06.00 Alaris Pump module

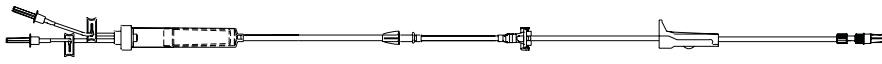
06.03.02 Low sorbing tubing | No port sets

Administration sets for use with the Alaris Pump module. All sets are latex free and contain an integrated safety clamp fitment to help prevent accidental free flow. Configurations are available with integrated SmartSite needle-free valves and VersaSafe split septum ports.



Model #	Drops	Description	Case quantity
10062818	15	 <p>Non-vented blood set with blunt short spike, 180 micron filter, low sorbing tubing segment, 2-piece male luer lock</p> <p>Approximate set length: 122" 310 cm. approx.</p> <p>Approximate priming volume: 33 mL</p>	 10
11426964	20	 <p>Low sorbing infusion set, 2-piece male luer lock</p> <p>Approximate set length: 47" 119 cm. approx.</p> <p>Approximate priming volume: 14 mL</p>	 20
C24117	20	 <p>Low sorbing infusion set, 2-piece male luer lock</p> <p>Approximate set length: 113" 287 cm. approx.</p> <p>Approximate priming volume: 23 mL</p>	 20

06.00 Alaris Pump module

06.03.03 Low sorbing tubing | VersaSafe split septum sets

Administration sets for use with the Alaris Pump module. All sets are latex free and contain an integrated safety clamp fitment to help prevent accidental free flow. Configurations are available with integrated SmartSite needle-free valves and VersaSafe split septum ports.



Model #	Drops	Description	Case quantity
---------	-------	-------------	---------------

2131-0500

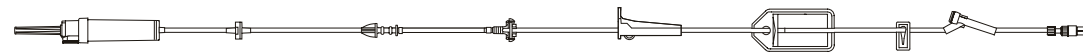

Low sorbing infusion set, check valve, 0.2 micron (low-protein binding) filter,
1 split septum port 6" from 2-piece male luer lock

20

Approximate set length: 115" 292 cm. approx.

Approximate priming volume: 26 mL

11130148

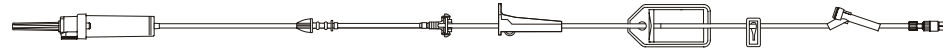

Low sorbing infusion set, 0.2 micron (low-protein binding) filter, 1 split septum port
6" from 2-piece male luer lock

20

Approximate set length: 115" 292 cm. approx.

Approximate priming volume: 26 mL

06.00 Alaris Pump module



06.04.01.01 Filters | Blood filters | SmartSite valve sets

Administration sets for use with the Alaris Pump module. All sets are latex free and contain an integrated safety clamp fitment to help prevent accidental free flow. Configurations are available with integrated SmartSite needle-free valves and VersaSafe split septum ports.

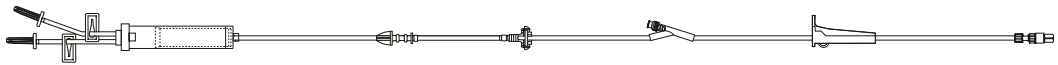

Model #	Drops	Description	Case quantity
---------	-------	-------------	---------------

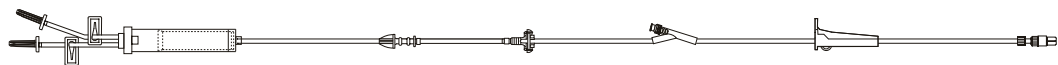
2477-0000	15	 <p>Non-vented blood set, 180 micron filter, 1 needle-free valve 65" from 2-piece male luer lock</p> <p>Approximate set length: 122" 310 cm. approx.</p> <p>Approximate priming volume: 34 mL</p>	10
-----------	----	--	----

2477-0007	15	 <p>Non-vented blood set, 180 micron filter, low sorbing tubing segment, 1 needle-free valve 65" from 2-piece male luer lock</p> <p>Approximate set length: 122" 310 cm. approx.</p> <p>Approximate priming volume: 33 mL</p>	 10
-----------	----	--	--

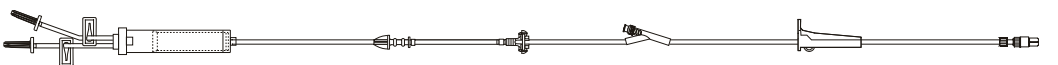
2478-0000	15	 <p>Non-vented blood set with blunt short spike, 180 micron filter, 1 needle-free valve 43" from 2-piece male luer lock</p> <p>Approximate set length: 100" 254 cm. approx.</p> <p>Approximate priming volume: 31 mL</p>	10
-----------	----	---	----





10013037	15	 <p>Non-vented blood set, 180 micron filter, 1 needle-free valve 65" from 2-piece male luer lock</p> <p>Approximate set length: 125" 318 cm. approx.</p> <p>Approximate priming volume: 34 mL</p>	10
----------	----	--	----

06.00 Alaris Pump module

06.04.01.02 Filters | Blood filters | No port sets

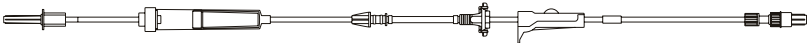
Administration sets for use with the Alaris Pump module. All sets are latex free and contain an integrated safety clamp fitment to help prevent accidental free flow. Configurations are available with integrated SmartSite needle-free valves and VersaSafe split septum ports.

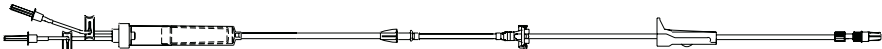

Model #	Drops	Description	Case quantity
2278-0500	20	 <p>Non-vented blood set with single spike, 200 micron filter, smallbore tubing segment, 2-piece male luer lock</p> <p>Approximate set length: 121" 308 cm. approx.</p> <p>Approximate priming volume: 22 mL</p>	20
10015414	15	 <p>Non-vented blood set, 180 micron filter, 2-piece male luer lock</p> <p>Approximate set length: 126" 320 cm. approx.</p> <p>Approximate priming volume: 38 mL</p>	10
10062818	15	 <p>Non-vented blood set with blunt short spike, 180 micron filter, low sorbing tubing segment, 2-piece male luer lock</p> <p>Approximate set length: 122" 310 cm. approx.</p> <p>Approximate priming volume: 33 mL</p>	 10

06.00 Alaris Pump module

06.04.01.03 Filters | Blood filters | VersaSafe split septum sets

Administration sets for use with the Alaris Pump module. All sets are latex free and contain an integrated safety clamp fitment to help prevent accidental free flow. Configurations are available with integrated SmartSite needle-free valves and VersaSafe split septum ports.



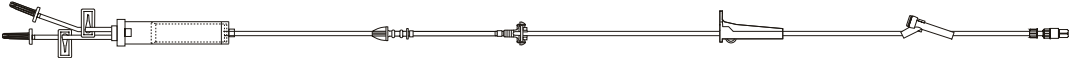





Model #	Drops	Description	Case quantity
2177-0000	15	 <p data-bbox="321 556 899 617">Non-vented blood set, 180 micron filter, 1 split septum port 65" from 2-piece male luer lock</p> <p data-bbox="321 638 1003 665">Approximate set length: 122" 310 cm. approx.</p> <p data-bbox="321 678 724 705">Approximate priming volume: 34 mL</p>	20

06.00 Alaris Pump module

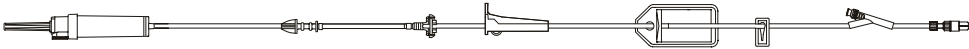
06.04.02.01 Filters | 0.2 micron filters | SmartSite valve sets

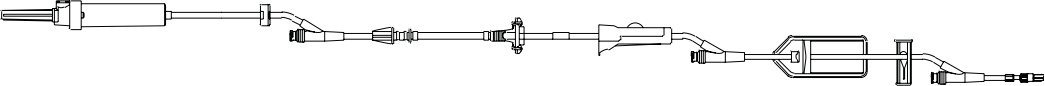
Administration sets for use with the Alaris Pump module. All sets are latex free and contain an integrated safety clamp fitment to help prevent accidental free flow. Configurations are available with integrated SmartSite needle-free valves and VersaSafe split septum ports.

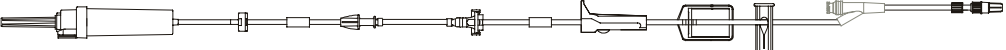







Model #	Drops	Description	Case quantity
2412-0500	20	 <p>Infusion set, 0.2 micron (low-protein binding) filter, 1 needle-free valve 6" from 2-piece male luer lock</p> <p>Approximate set length: 109" 277 cm. approx.</p> <p>Approximate priming volume: 26 mL</p>	20
2430-0500	20	 <p>Infusion set, check valve, 0.2 micron (low-protein binding) filter, 2 needle-free valves 85" and 6" from 2-piece male luer lock</p> <p>Approximate set length: 116" 294 cm. approx.</p> <p>Approximate priming volume: 27 mL</p>	20
2432-0007	20	 <p>Infusion set, check valve, 0.2 micron (low protein binding) filter, 3 needle-free valves 86", 20" and 6" from 2-piece male luer lock</p> <p>Approximate set length: 118" 299 cm. approx.</p> <p>Approximate priming volume: 28 mL</p>	 20
2434-0007	20	 <p>Infusion set, vented/non-vented, 0.2 micron (low protein binding) filter, 1 needle-free valve 6" from 2-piece male luer lock</p> <p>Approximate set length: 115" 292 cm. approx.</p> <p>Approximate priming volume: 28 mL</p>	 20
2443-0600	60	 <p>Infusion set, 150 mL burette (needle-free valve), smallbore tubing segment, 0.2 micron (low-protein binding) filter, 3 needle-free valves 81", 55" and 6" from 2-piece male luer lock</p> <p>Approximate set length: 132" 335 cm. approx.</p> <p>Approximate priming volume: 24 mL</p>	10

06.00 Alaris Pump module

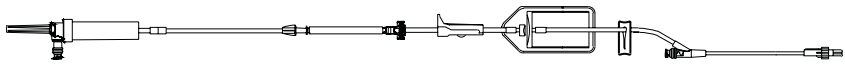
06.04.02.01 Filters | 0.2 micron filters | SmartSite valve sets

Administration sets for use with the Alaris Pump module. All sets are latex free and contain an integrated safety clamp fitment to help prevent accidental free flow. Configurations are available with integrated SmartSite needle-free valves and VersaSafe split septum ports.

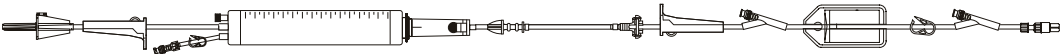
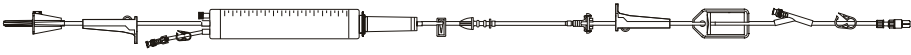

Model #	Drops	Description	Case quantity
2465-0007	20	 <p>Low sorbing infusion set, non-vented, needle-free bag access port, 20 drop, 0.2 micron (low protein binding) filter, 1 needle-free valve 6" from 2-piece male luer lock</p> <p>Approximate set length: 116" 293 cm. approx.</p> <p>Approximate priming volume: 26 mL</p>	 20
10010454	20	 <p>Low sorbing infusion set, 0.2 micron (low-protein binding) filter, 1 needle-free valve 6" from 2-piece male luer lock</p> <p>Approximate set length: 115" 291 cm. approx.</p> <p>Approximate priming volume: 26 mL</p>	 20
10012283	60	 <p>Infusion set, 150 mL burette (needle-free valve), ball valve in drip chamber, 0.2 micron (low-protein binding) filter, 2 needle-free valves 52" and 7" from 2-piece male luer lock</p> <p>Approximate set length: 129" 328 cm. approx.</p> <p>Approximate priming volume: 27 mL</p>	10
10015012	20	 <p>Infusion set, 150 mL burette (needle-free valve), low sorbing and smallbore tubing segments, 0.2 micron (low-protein binding) filter, 1 needle-free valve 6" from 2-piece male luer lock</p> <p>Approximate set length: 125" 318 cm. approx.</p> <p>Approximate priming volume: 26 mL</p>	 10

06.00 Alaris Pump module

06.04.02.01 Filters | 0.2 micron filters | SmartSite valve sets

Administration sets for use with the Alaris Pump module. All sets are latex free and contain an integrated safety clamp fitment to help prevent accidental free flow. Configurations are available with integrated SmartSite needle-free valves and VersaSafe split septum ports.



Model #	Drops	Description	Case quantity
---------	-------	-------------	---------------

10406194

20

30-day lead time

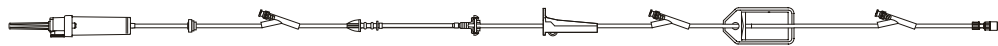

Infusion set, low sorbing and smallbore tubing segments, check valve, 0.2 micron (low-protein binding) filter, 3 needle-free valves 66", 46" and 6" from 2-piece male luer lock



10

Approximate set length: 154" 391 cm. approx.
 Approximate priming volume: 28 mL

11118122

60

30-day lead time



Infusion set, 150 mL burette (needle-free valve), 0.2 micron (low-protein binding) filter, 3 needle-free valves 89", 62" and 6" from 2-piece male luer lock



10

Approximate set length: 129" 328 cm. approx.
 Approximate priming volume: 28 mL

11532269

20



Low sorbing infusion set, check valve, 0.2 micron (low-protein binding) filter, 2 needle-free valves 87" and 6" from 2-piece male luer lock



20

Approximate set length: 124" 315 cm. approx.
 Approximate priming volume: 28 mL

11609481

20

30-day lead time

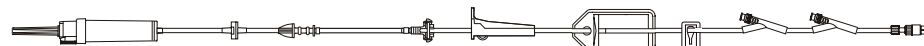

Low sorbing infusion set, check valve, 0.2 micron (low-protein binding) filter, 2 needle-free valves 12" and 6" from 2-piece male luer lock



20

Approximate set length: 124" 315 cm. approx.
 Approximate priming volume: 28 mL

06.00 Alaris Pump module

06.04.02.01 Filters | 0.2 micron filters | SmartSite valve sets

Administration sets for use with the Alaris Pump module. All sets are latex free and contain an integrated safety clamp fitment to help prevent accidental free flow. Configurations are available with integrated SmartSite needle-free valves and VersaSafe split septum ports.



Model #	Drops	Description	Case quantity
---------	-------	-------------	---------------

11613191

60

30-day lead time



Infusion set, 150 mL burette (needle-free valve), ball valve in drip chamber, low sorbing tubing segment, 0.2 micron (low-protein binding) filter, 2 needle-free valves 51" and 7" from 2-piece male luer lock



10

Approximate set length: 130" 330 cm. approx.
 Approximate priming volume: 27 mL

C24101E

20

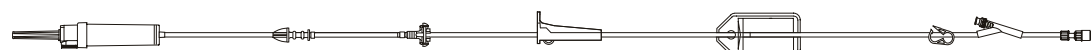

Infusion set, amber tubing, 15 micron filter (drip chamber), 0.2 micron (low-protein binding) filter, 1 needle-free valve 6" from 2-piece male luer lock

20

Approximate set length: 106" 269 cm. approx.
 Approximate priming volume: 25 mL

C24103E

20

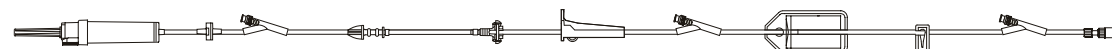

Infusion set, check valve, 0.2 micron (low-protein binding) filter, 3 needle-free valves 90", 21" and 6" from 2-piece male luer lock

20

Approximate set length: 117" 297 cm. approx.
 Approximate priming volume: 28 mL

06.00 Alaris Pump module

06.04.02.01 Filters | 0.2 micron filters | SmartSite valve sets

Administration sets for use with the Alaris Pump module. All sets are latex free and contain an integrated safety clamp fitment to help prevent accidental free flow. Configurations are available with integrated SmartSite needle-free valves and VersaSafe split septum ports.



Model #	Drops	Description	Case quantity
---------	-------	-------------	---------------

C24119E

20

30-day lead time

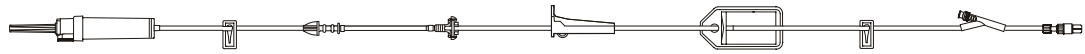

Infusion set, 0.2 micron (low-protein binding) filter, 1 needle-free valve
6" from 2-piece male luer lock

20



Approximate set length: 115" 292 cm. approx.
Approximate priming volume: 26 mL

06.00 Alaris Pump module

06.04.02.02 Filters | 0.2 micron filters | No port sets

Administration sets for use with the Alaris Pump module. All sets are latex free and contain an integrated safety clamp fitment to help prevent accidental free flow. Configurations are available with integrated SmartSite needle-free valves and VersaSafe split septum ports.



Model #	Drops	Description	Case quantity
11045328	20	 <p>Infusion set, 150 mL burette (needle-free valve), 0.2 micron (low-protein binding) filter, 2-piece male luer lock</p> <p>Approximate set length: 123" 312 cm. approx.</p> <p>Approximate priming volume: 30 mL</p>	10
11612593	20	 <p>Infusion set, 0.2 micron (low-protein binding) filter, 2-piece male luer lock</p> <p>Approximate set length: 112" 284 cm. approx.</p> <p>Approximate priming volume: 27 mL</p>	20



30-day lead time

06.00 Alaris Pump module

06.04.02.03 Filters | 0.2 micron filters | VersaSafe split septum sets

Administration sets for use with the Alaris Pump module. All sets are latex free and contain an integrated safety clamp fitment to help prevent accidental free flow. Configurations are available with integrated SmartSite needle-free valves and VersaSafe split septum ports.

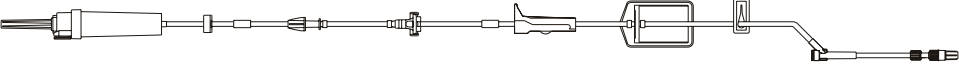

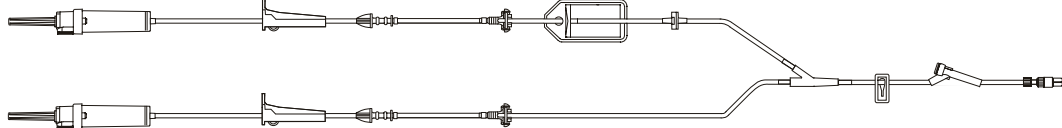
Model #	Drops	Description	Case quantity
2121-0500 30-day lead time	20	 <p>Infusion set, vented/non-vented, 0.2 micron (low-protein binding) filter, check valve, 1 split septum port 6" from 2-piece male luer lock</p> <p>Approximate set length: 115" 293 cm. approx.</p> <p>Approximate priming volume: 27 mL</p>	DEHP 20
2130-0500	20	 <p>Infusion set, check valve, 0.2 micron (low-protein binding) filter, 2 split septum ports 85" and 6" from 2-piece male luer lock</p> <p>Approximate set length: 116" 295 cm. approx.</p> <p>Approximate priming volume: 28 mL</p>	20
11130148	20	 <p>Low sorbing infusion set, 0.2 micron (low-protein binding) filter, 1 split septum port 6" from 2-piece male luer lock</p> <p>Approximate set length: 115" 292 cm. approx.</p> <p>Approximate priming volume: 26 mL</p>	20
11202653	20	 <p>Infusion set, 0.2 micron (low-protein binding) filter, low sorbing tubing segment on non-filter side, 1 split septum port 12" from 2-piece male luer lock</p> <p>Approximate set length: 133" 338 cm. approx.</p> <p>Approximate priming volume: 51 mL</p>	10

06.00 Alaris Pump module

06.04.03.01 Filters | 1.2 micron filters | SmartSite valve sets

Administration sets for use with the Alaris Pump module. All sets are latex free and contain an integrated safety clamp fitment to help prevent accidental free flow. Configurations are available with integrated SmartSite needle-free valves and VersaSafe split septum ports.



Model #	Drops	Description	Case quantity
---------	-------	-------------	---------------

10010453



Low sorbing infusion set, 1.2 micron (low-protein binding) filter, 1 needle-free valve
6" from 2-piece male luer lock



20



Approximate set length: 115" 291 cm. approx.
Approximate priming volume: 26 mL

06.00 Alaris Pump module

06.04.03.02 Filters | 1.2 micron filters | No port sets

Administration sets for use with the Alaris Pump module. All sets are latex free and contain an integrated safety clamp fitment to help prevent accidental free flow. Configurations are available with integrated SmartSite needle-free valves and VersaSafe split septum ports.

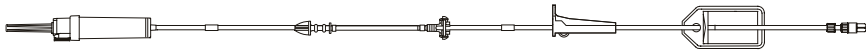
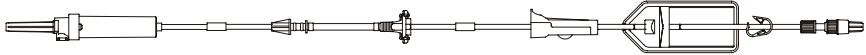

Model #	Drops	Description	Case quantity
2202-0500	20	 <p>Infusion set, 1.2 micron (low-protein binding) filter, 2-piece male luer lock</p> <p>Approximate set length: 122" 310 cm. approx.</p> <p>Approximate priming volume: 28 mL</p>	20
2202-0007	20	 <p>Infusion set, vented/non-vented, 1.2 micron (low-protein binding) filter, 2-piece male luer lock</p> <p>Approximate set length: 122" 309 cm. approx.</p> <p>Approximate priming volume: 27 mL</p>	 20

06.00 Alaris Pump module

06.04.03.03 Filters | 1.2 micron filters | VersaSafe split septum sets

Administration sets for use with the Alaris Pump module. All sets are latex free and contain an integrated safety clamp fitment to help prevent accidental free flow. Configurations are available with integrated SmartSite needle-free valves and VersaSafe split septum ports.



Model #	Drops	Description	Case quantity
---------	-------	-------------	---------------

2131-0500

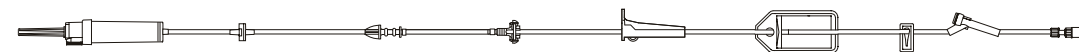

Low sorbing infusion set, check valve, 0.2 micron (low-protein binding) filter,
1 split septum port 6" from 2-piece male luer lock

20

Approximate set length: 115" 292 cm. approx.

Approximate priming volume: 26 mL

06.00 Alaris Pump module

06.04.04.01 Filters | 15 micron filters | SmartSite valve sets

Administration sets for use with the Alaris Pump module. All sets are latex free and contain an integrated safety clamp fitment to help prevent accidental free flow. Configurations are available with integrated SmartSite needle-free valves and VersaSafe split septum ports.



Model #	Drops	Description	Case quantity
---------	-------	-------------	---------------

2414-0500	20	 <p>Infusion set, 15 micron filter (drip chamber), 2 needle-free valves 78" and 6" from 2-piece male luer lock</p>	20
		<p>Approximate set length: 115" 292 cm. approx.</p>	
		<p>Approximate priming volume: 24 mL</p>	

10561554	20	 <p>Infusion set, 15 micron filter (drip chamber), check valve, 3 needle-free valves 86", 68" and 6" from 2-piece male luer lock</p>	20
		<p>Approximate set length: 127" 322 cm. approx.</p>	
		<p>Approximate priming volume: 27 mL</p>	

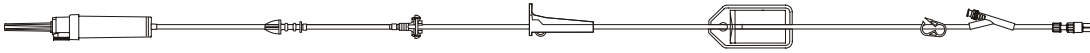

C24101E	20	 <p>Infusion set, amber tubing, 15 micron filter (drip chamber), 0.2 micron (low-protein binding) filter, 1 needle-free valve 6" from 2-piece male luer lock</p>	20
		<p>Approximate set length: 106" 269 cm. approx.</p>	
		<p>Approximate priming volume: 25 mL</p>	

06.00 Alaris Pump module

06.04.04.02 Filters | 15 micron filters | No port sets

Administration sets for use with the Alaris Pump module. All sets are latex free and contain an integrated safety clamp fitment to help prevent accidental free flow. Configurations are available with integrated SmartSite needle-free valves and VersaSafe split septum ports.



Model #	Drops	Description	Case quantity
2203-0500	20	 <p>Infusion set, amber tubing, 15 micron filter (drip chamber), spin male luer lock</p> <p>Approximate set length: 110" 279 cm. approx.</p> <p>Approximate priming volume: 24 mL</p>	20
10863358	20	 <p>Infusion set, 15 micron filter (drip chamber), 2-piece male luer lock</p> <p>Approximate set length: 117" 297 cm. approx.</p> <p>Approximate priming volume: 24 mL</p>	 20

30-day lead time

06.00 Alaris Pump module

06.04.04.03 Filters | 15 micron filters | VersaSafe split septum sets

Administration sets for use with the Alaris Pump module. All sets are latex free and contain an integrated safety clamp fitment to help prevent accidental free flow. Configurations are available with integrated SmartSite needle-free valves and VersaSafe split septum ports.



Model #	Drops	Description	Case quantity
---------	-------	-------------	---------------

11133698

20



Infusion set, 15 micron filter (drip chamber), 2 split septum ports
83" and 6" from 2-piece male luer lock

20

Approximate set length: 115" 292 cm. approx.

Approximate priming volume: 25 mL

06.00 Alaris Pump module

06.05.01 Special applications | Yellow striped tubing sets

Administration sets for use with the Alaris Pump module. All sets are latex free and contain an integrated safety clamp fitment to help prevent accidental free flow. Configurations are available with integrated SmartSite needle-free valves and VersaSafe split septum ports.



Model #	Drops	Description	Case quantity
---------	-------	-------------	---------------

2206-0007

20

30-day lead time



Infusion set, microbore yellow striped tubing, 2-piece male luer lock

Approximate set length: 97" 247 cm. approx.

Approximate priming volume: 13 mL



20

10010761

20



Infusion set, microbore yellow striped tubing, 2-piece male luer lock

Approximate set length: 99" 251 cm. approx.

Approximate priming volume: 14 mL

20

10011301

20



Infusion set, check valve, microbore yellow striped tubing, 2-piece male luer lock

Approximate set length: 118" 300 cm. approx.

Approximate priming volume: 15 mL

20

06.00 Alaris Pump module

06.05.02 Special applications | Amber tubing sets

Administration sets for use with the Alaris Pump module. All sets are latex free and contain an integrated safety clamp fitment to help prevent accidental free flow. Configurations are available with integrated SmartSite needle-free valves and VersaSafe split septum ports.



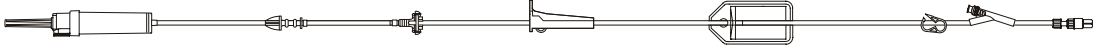





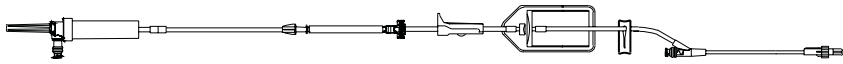

Model #	Drops	Description	Case quantity
2203-0500	20	 <p>Infusion set, amber tubing, 15 micron filter (drip chamber), spin male luer lock</p> <p>Approximate set length: 110" 279 cm. approx.</p> <p>Approximate priming volume: 24 mL</p>	20
C24101E	20	 <p>Infusion set, amber tubing, 15 micron filter (drip chamber), 0.2 micron (low-protein binding) filter, 1 needle-free valve 6" from 2-piece male luer lock</p> <p>Approximate set length: 106" 269 cm. approx.</p> <p>Approximate priming volume: 25 mL</p>	20

06.00 Alaris Pump module

06.05.03 Special applications | SmartSite bag access port sets

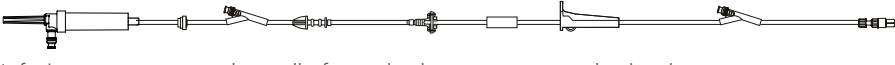
Administration sets for use with the Alaris Pump module. All sets are latex free and contain an integrated safety clamp fitment to help prevent accidental free flow. Configurations are available with integrated SmartSite needle-free valves and VersaSafe split septum ports.



Model #	Drops	Description	Case quantity
2465-0007	20	 <p>Low sorbing infusion set, non-vented, needle-free bag access port, 20 drop, 0.2 micron (low protein binding) filter, 1 needle-free valve 6" from 2-piece male luer lock</p> <p>Approximate set length: 116" 293 cm. approx.</p> <p>Approximate priming volume: 26 mL</p>	 20
2466-0007	20	 <p>Low sorbing infusion set, non-vented, needle-free bag access port, spin male luer lock</p> <p>Approximate set length: 86" 219 cm. approx.</p> <p>Approximate priming volume: 20 mL</p>	 20
10013361	20	 <p>Infusion set, non-vented, needle-free valve bag access port, check valve, 2 needle-free valves 78" and 6" from 2-piece male luer lock</p> <p>Approximate set length: 117" 297 cm. approx.</p> <p>Approximate priming volume: 25 mL</p>	 20
10014855	20	 <p>Low sorbing infusion set, non-vented, needle-free valve bag access port, check valve, 2 needle-free valves 95" and 6" from 2-piece male luer lock</p> <p>Approximate set length: 116" 295 cm. approx.</p> <p>Approximate priming volume: 24 mL</p>	 20







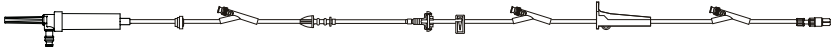

30-day lead time

06.00 Alaris Pump module

06.05.03 Special applications | SmartSite bag access port sets

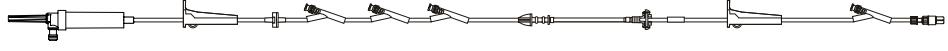
Administration sets for use with the Alaris Pump module. All sets are latex free and contain an integrated safety clamp fitment to help prevent accidental free flow. Configurations are available with integrated SmartSite needle-free valves and VersaSafe split septum ports.

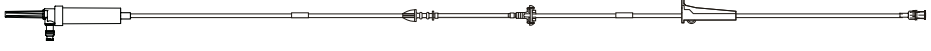



Model #	Drops	Description	Case quantity
10015861 30-day lead time	20	 <p>Infusion set, non-vented, needle-free valve bag access port, low sorbing tubing, check valve, 3 needle-free valves 95", 75" and 6" from 2-piece male luer lock</p> <p>Approximate set length: 128" 325 cm. approx.</p> <p>Approximate priming volume: 26 mL</p>	 20
10015862	20	 <p>Infusion set, non-vented, needle-free valve bag access port, low sorbing tubing, 2-piece male luer lock</p> <p>Approximate set length: 44" 112 cm. approx.</p> <p>Approximate priming volume: 14 mL</p>	 20
10061661 30-day lead time	20	 <p>Infusion set, non-vented, needle-free valve bag access port, low sorbing tubing, check valve, 4 needle-free valves 94", 92", 90" and 6" from 2-piece male luer lock</p> <p>Approximate set length: 121" 307 cm. approx.</p> <p>Approximate priming volume: 25 mL</p>	 20
10321213	20	 <p>Infusion set, non-vented, needle-free valve bag access port, fixed male luer lock</p> <p>Approximate set length: 106" 269 cm. approx.</p> <p>Approximate priming volume: 23 mL</p>	 20

06.00 Alaris Pump module

06.05.04 Special applications | Ball valve sets

Administration sets for use with the Alaris Pump module. All sets are latex free and contain an integrated safety clamp fitment to help prevent accidental free flow. Configurations are available with integrated SmartSite needle-free valves and VersaSafe split septum ports.

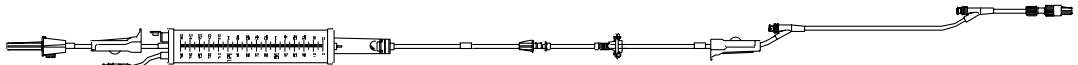
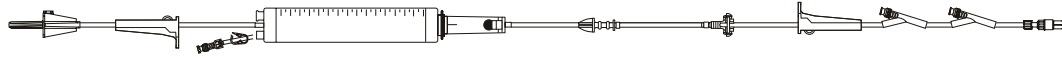

Model #	Drops	Description	Case quantity
2125-0500	20	 <p>Infusion set, check valve, ball valve in drip chamber, 2 split septum ports 86" and 6" from 2-piece male luer lock</p> <p>Approximate set length: 118" 300 cm. approx.</p> <p>Approximate priming volume: 24 mL</p>	20
2147-0600	60	 <p>Infusion set, 150 mL burette (split septum port), ball valve in drip chamber, smallbore tubing segment, 3 split septum ports 86", 60" and 7" from 2-piece male luer lock</p> <p>Approximate set length: 132" 335 cm. approx.</p> <p>Approximate priming volume: 20 mL</p>	10
2425-0500	20	 <p>Infusion set, ball valve in drip chamber, check valve, 2 needle-free valves 85" and 6" from 2-piece male luer lock</p> <p>Approximate set length: 117" 297 cm. approx.</p> <p>Approximate priming volume: 24 mL</p>	20
2447-0007	60	 <p>Infusion set, 150 mL burette (needle-free valve), ball valve in drip chamber, 2 needle-free valves 60" and 7" from 2-piece male luer lock</p> <p>Approximate set length: 129" 328 cm. approx.</p> <p>Approximate priming volume: 24 mL</p>	10
2447-0600	60	 <p>Infusion set, 150 mL burette set (needle-free valve), ball valve in drip chamber, smallbore tubing segment, 2 needle-free valves 60" and 7" from 2-piece male luer lock</p> <p>Approximate set length: 131" 333 cm. approx.</p> <p>Approximate priming volume: 19 mL</p>	10



06.00 Alaris Pump module

06.05.04 Special applications | Ball valve sets

Administration sets for use with the Alaris Pump module. All sets are latex free and contain an integrated safety clamp fitment to help prevent accidental free flow. Configurations are available with integrated SmartSite needle-free valves and VersaSafe split septum ports.



Model #	Drops	Description	Case quantity
---------	-------	-------------	---------------

10011652

20

30-day lead time



Infusion set, ball valve in drip chamber, 2 needle-free valves 83" and 6" from 2-piece male luer lock

20

Approximate set length: 117" 297 cm. approx.

Approximate priming volume: 23 mL

10012283

60



Infusion set, 150 mL burette (needle-free valve), ball valve in drip chamber, 0.2 micron (low-protein binding) filter, 2 needle-free valves 52" and 7" from 2-piece male luer lock

10

Approximate set length: 129" 328 cm. approx.

Approximate priming volume: 27 mL

10012293

60

30-day lead time

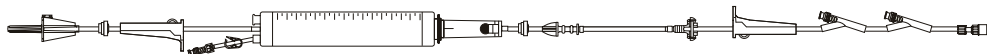

Infusion set, 150 mL burette (needle-free valve), ball valve in drip chamber, smallbore tubing segment, 2 check valves, 2 needle-free valves 64" and 8" from 2-piece male luer lock

10

Approximate set length: 137" 348 cm. approx.

Approximate priming volume: 20 mL

10817920

60

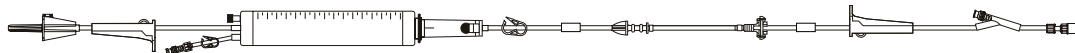

Infusion set, 150 mL burette (needle-free valve), ball valve in drip chamber, smallbore tubing segment, 1 needle-free valve 7" from 2-piece male luer lock



10

Approximate set length: 123" 312 cm. approx.

Approximate priming volume: 19 mL

06.00 Alaris Pump module

06.05.04 Special applications | Ball valve sets

Administration sets for use with the Alaris Pump module. All sets are latex free and contain an integrated safety clamp fitment to help prevent accidental free flow. Configurations are available with integrated SmartSite needle-free valves and VersaSafe split septum ports.



Model #	Drops	Description	Case quantity
---------	-------	-------------	---------------

11522558

20

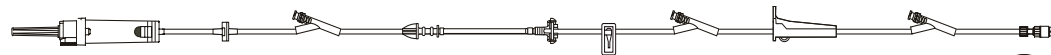

Infusion set, ball valve in drip chamber, check valve, 3 needle-free valves
96", 75" and 6" from 2-piece male luer lock

Approximate set length: 126" 320 cm. approx.

Approximate priming volume: 25 mL



20

11613191

60

30-day lead time



Infusion set, 150 mL burette (needle-free valve), ball valve in drip chamber,
low sorbing tubing segment, 0.2 micron (low-protein binding) filter,
2 needle-free valves 51" and 7" from 2-piece male luer lock

Approximate set length: 130" 330 cm. approx.

Approximate priming volume: 27 mL



10

06.00 Alaris Pump module

06.05.05 Special applications | Syringe adapter sets

Administration sets for use with the Alaris Pump module. All sets are latex free and contain an integrated safety clamp fitment to help prevent accidental free flow. Configurations are available with integrated SmartSite needle-free valves and VersaSafe split septum ports. Syringe clip holder 8101A available for use with Alaris Pump module syringe adapter sets.











Model #	Drops	Description	Case quantity
2280-0000		Syringe adapter set, microbore tubing segment, 2-piece male luer lock	20
	Approximate set length: 83" 211 cm. approx.		
	Approximate priming volume: 4 mL		
10010483		Syringe adapter set, smallbore tubing, 2-piece male luer lock	20
	Approximate set length: 83" 211 cm. approx.		
	Approximate priming volume: 4 mL		

06.00 Alaris Pump module

06.06.01 Primary administration sets | SmartSite valve sets

Administration sets for use with the Alaris Pump module. All sets are latex free and contain an integrated safety clamp fitment to help prevent accidental free flow. Configurations are available with integrated SmartSite needle-free valves and VersaSafe split septum ports.









Model #	Drops	Description	Case quantity
2401-0500	20	 <p>Infusion set, 1 needle-free valve 6" from 2-piece male luer lock</p> <p>Approximate set length: 109" 277 cm. approx.</p> <p>Approximate priming volume: 23 mL</p>	20
2403-0000		 <p>Infusion half set, 1 needle-free valve 6" from 2-piece male luer lock</p> <p>Approximate set length: 86" 218 cm. approx.</p> <p>Approximate priming volume: 13 mL</p>	20
2403-0007	30-day lead time	 <p>Infusion half set, 1 needle-free valve 6" from 2-piece male luer lock</p> <p>Approximate set length: 86" 218 cm. approx.</p> <p>Approximate priming volume: 13 mL</p>	 20
2410-0500	20	 <p>Infusion set, 2 needle-free valves 84" and 6" from 2-piece male luer lock</p> <p>Approximate set length: 115" 292 cm. approx.</p> <p>Approximate priming volume: 25 mL</p>	20
2411-0500	60	 <p>Infusion set, smallbore tubing segment, 2 needle-free valves 86" and 7" from 2-piece male luer lock</p> <p>Approximate set length: 116" 295 cm. approx.</p> <p>Approximate priming volume: 19 mL</p>	20
2420-0007	20	 <p>Infusion set, check valve, 2 needle-free valves 83" and 6" from 2-piece male luer lock</p> <p>Approximate set length: 117" 297 cm. approx.</p> <p>Approximate priming volume: 25 mL</p>	 20

06.00 Alaris Pump module

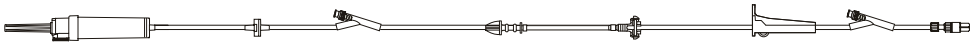
06.06.01 Primary administration sets | SmartSite valve sets

Administration sets for use with the Alaris Pump module. All sets are latex free and contain an integrated safety clamp fitment to help prevent accidental free flow. Configurations are available with integrated SmartSite needle-free valves and VersaSafe split septum ports.

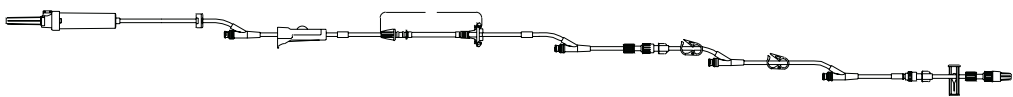



Model #	Drops	Description	Case quantity
2420-0500	20	 <p>Infusion set, check valve, 2 needle-free valves 79" and 6" from 2-piece male luer lock</p> <p>Approximate set length: 117" 297 cm. approx.</p> <p>Approximate priming volume: 25 mL</p>	20
2421-0500	60	 <p>Infusion set, check valve, 2 needle-free valves 78" and 6" from 2-piece male luer lock</p> <p>Approximate set length: 117" 297 cm. approx.</p> <p>Approximate priming volume: 25 mL</p>	20
2426-0007	20	 <p>Infusion set, check valve, 3 needle-free valves 95", 75" and 6" from 2-piece male luer lock</p> <p>Approximate set length: 127" 322 cm. approx.</p> <p>Approximate priming volume: 26 mL</p>	 20
2426-0500	20	 <p>Infusion set, check valve, 3 needle-free valves 83", 63" and 6" from 2-piece male luer lock</p> <p>Approximate set length: 126" 321 cm. approx.</p> <p>Approximate priming volume: 26 mL</p>	20
2429-0007	20	 <p>Infusion set, check valve, 4 needle-free valves 134", 46", 33" and 13" from 2-piece male luer lock</p> <p>Approximate set length: 156" 396 cm. approx.</p> <p>Approximate priming volume: 30 mL</p>	 20

06.00 Alaris Pump module

06.06.01 Primary administration sets | SmartSite valve sets

Administration sets for use with the Alaris Pump module. All sets are latex free and contain an integrated safety clamp fitment to help prevent accidental free flow. Configurations are available with integrated SmartSite needle-free valves and VersaSafe split septum ports.

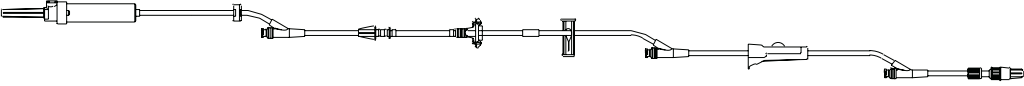
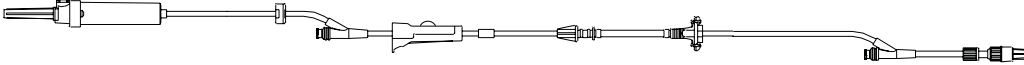

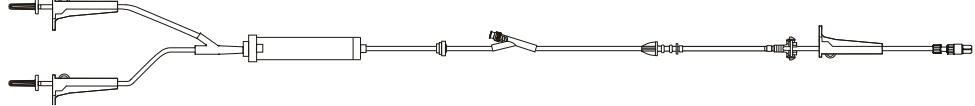
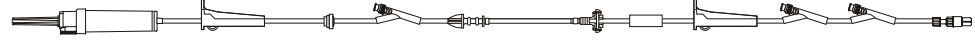
Model #	Drops	Description	Case quantity
2429-0500	20	 <p>Infusion set, check valve, 3 needle-free valves 81", 42" and 6" from 2-piece male luer lock Approximate set length: 110" 278 cm. approx. Approximate priming volume: 24 mL</p>	20
2433-0007	20	 <p>Infusion set, check valve, 2 needle-free valves 88" and 6" from 2-piece male luer lock Approximate set length: 117" 298 cm. approx. Approximate priming volume: 25 mL</p>	20
2455-0500	20	 <p>Infusion set, 1 needle-free valve 12" from 2-piece male luer lock Approximate set length: 56" 142 cm. approx. Approximate priming volume: 16 mL</p>	20
10012144	20	 <p>Infusion set, check valve, 3 needle-free valves 76", 42" and 6" from 2-piece male luer lock Approximate set length: 125" 318 cm. approx. Approximate priming volume: 26 mL</p>	20
10012645	20	 <p>Non-vented infusion set with in-line drip chamber, check valve, 1 needle-free valve 65" from 2-piece male luer lock Approximate set length: 122" 309 cm. approx. Approximate priming volume: 29 mL</p>	10
10013186	60	 <p>Infusion set, check valve, 3 needle-free valves 84", 37" and 6" from 2-piece male luer lock Approximate set length: 118" 300 cm. approx. Approximate priming volume: 26 mL</p>	20







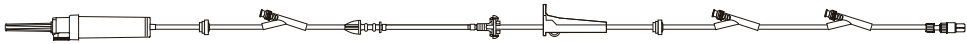

06.00 Alaris Pump module

06.06.01 Primary administration sets | SmartSite valve sets

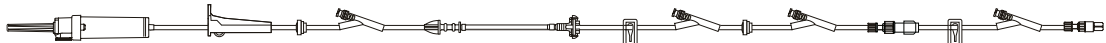
Administration sets for use with the Alaris Pump module. All sets are latex free and contain an integrated safety clamp fitment to help prevent accidental free flow. Configurations are available with integrated SmartSite needle-free valves and VersaSafe split septum ports.



Model #	Drops	Description	Case quantity
10015294	20	 <p>Infusion set, 2 check valves, 3 needle-free valves 118", 43" and 6" from 2-piece male luer lock</p> <p>Approximate set length: 140" 356 cm. approx.</p> <p>Approximate priming volume: 29 mL</p>	20
10015645	20	 <p>Infusion set, 2 needle-free valves 86" and 6" from 2-piece male luer lock</p> <p>Approximate set length: 117" 297 cm. approx.</p> <p>Approximate priming volume: 25 mL</p>	 20
10031773	20	 <p>Infusion set, 2 check valves, 4 needle-free valves 109", 61", 35" and 5" from 2-piece male luer lock</p> <p>Approximate set length: 139" 353 cm. approx.</p> <p>Approximate priming volume: 29 mL</p>	20
10178573	20	 <p>Infusion set, check valve, 4 needle-free valves 95", 42", 13" and 6" from 2-piece male luer lock</p> <p>Approximate set length: 128" 325 cm. approx.</p> <p>Approximate priming volume: 27 mL</p>	20
10404198	20	 <p>Infusion set, check valve, 3 needle-free valves 59", 49" and 6" from 2-piece male luer lock</p> <p>Approximate set length: 154" 391 cm. approx.</p> <p>Approximate priming volume: 31 mL</p>	 20





30-day lead time

06.00 Alaris Pump module

06.06.01 Primary administration sets | SmartSite valve sets

Administration sets for use with the Alaris Pump module. All sets are latex free and contain an integrated safety clamp fitment to help prevent accidental free flow. Configurations are available with integrated SmartSite needle-free valves and VersaSafe split septum ports.

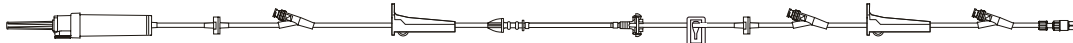









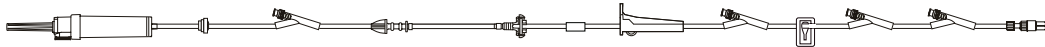

Model #	Drops	Description	Case quantity
10408730	20	 <p>Infusion set, check valve, 3 needle-free valves 72", 42" and 6" from 2-piece male luer lock</p> <p>Approximate set length: 125" 318 cm. approx.</p> <p>Approximate priming volume: 26 mL</p>	20
10879047	10	 <p>Infusion set, check valve, 2 needle-free valves 85" and 6" from 2-piece male luer lock</p> <p>Approximate set length: 117" 297 cm. approx.</p> <p>Approximate priming volume: 25 mL</p>	 20
10879391	20	 <p>Infusion set, 2 check valves, 3 needle-free valves 91", 45" and 6" from 2-piece male luer lock</p> <p>Approximate set length: 116" 295 cm. approx.</p> <p>Approximate priming volume: 25 mL</p>	20
10927766	20	 <p>Infusion set, check valve, 3 needle-free valves 94", 52" and 6" from 2-piece male luer lock</p> <p>Approximate set length: 125" 318 cm. approx.</p> <p>Approximate priming volume: 26 mL</p>	20
10933805	20	 <p>Infusion set, check valve, 2 roller clamps, 2 needle-free valves 85" and 6" from 2-piece male luer lock</p> <p>Approximate set length: 117" 297 cm. approx.</p> <p>Approximate priming volume: 25 mL</p>	20

06.00 Alaris Pump module

06.06.01 Primary administration sets | SmartSite valve sets

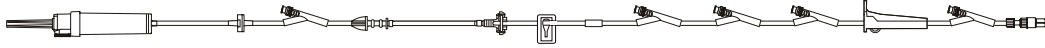
Administration sets for use with the Alaris Pump module. All sets are latex free and contain an integrated safety clamp fitment to help prevent accidental free flow. Configurations are available with integrated SmartSite needle-free valves and VersaSafe split septum ports.



Model #	Drops	Description	Case quantity
11171447	20	 <p>Infusion set, 2 check valves, 3 needle-free valves 96", 42" and 6" from 2-piece male luer lock</p> <p>Approximate set length: 126" 320 cm. approx.</p> <p>Approximate priming volume: 26 mL</p>	 20
11287205	20	 <p>Infusion set, 4 needle-free valves 97", 42", 13" and 6" from 2-piece male luer lock</p> <p>Approximate set length: 128" 325 cm. approx.</p> <p>Approximate priming volume: 26 mL</p>	 20
11404930	10	 <p>Infusion set, check valve, 3 needle-free valves 87", 37" and 6" from 2-piece male luer lock</p> <p>Approximate set length: 118" 300 cm. approx.</p> <p>Approximate priming volume: 25 mL</p>	 20
11426965	20	 <p>Infusion set, check valve, 5 needle-free valves 104", 75", 71", 67" and 6" from 2-piece male luer lock</p> <p>Approximate set length: 138" 351 cm. approx.</p> <p>Approximate priming volume: 28 mL</p>	 20
11484001	20	 <p>Infusion set, check valve, 1 needle-free valve 74" from 2-piece male luer lock</p> <p>Approximate set length: 106" 269 cm. approx.</p> <p>Approximate priming volume: 23 mL</p>	 20





30-day lead time

06.00 Alaris Pump module

06.06.01 Primary administration sets | SmartSite valve sets

Administration sets for use with the Alaris Pump module. All sets are latex free and contain an integrated safety clamp fitment to help prevent accidental free flow. Configurations are available with integrated SmartSite needle-free valves and VersaSafe split septum ports.









Model #	Drops	Description	Case quantity
11590100	60	 <p>Infusion set, check valve, 2 needle-free valves 76" and 6" from 2-piece male luer lock</p> <p>Approximate set length: 107" 272 cm. approx.</p> <p>Approximate priming volume: 23 mL</p>	20
11607704	20	 <p>Infusion set, check valve, 2 needle-free valves 88" and 6" from 2-piece male luer lock</p> <p>Approximate set length: 120" 305 cm. approx.</p> <p>Approximate priming volume: 25 mL</p>	20
C24105E	20	 <p>Infusion set, check valve, 5 needle-free valves 92", 60", 49", 26" and 6" from 2-piece male luer lock</p> <p>Approximate set length: 111" 281 cm. approx.</p> <p>Approximate priming volume: 24 mL</p>	20
C24111E	20	 <p>Infusion set, check valve, 3 needle-free valves 96", 63" and 6" from 2-piece male luer lock</p> <p>Approximate set length: 120" 305 cm. approx.</p> <p>Approximate priming volume: 26 mL</p>	20
C24116E	20	 <p>Infusion set, check valve, 2 needle-free valves 83" and 6" from 2-piece male luer lock</p> <p>Approximate set length: 117" 297 cm. approx.</p> <p>Approximate priming volume: 25 mL</p>	20

06.00 Alaris Pump module

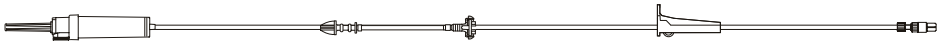
06.06.02 Primary administration sets | No port sets

Administration sets for use with the Alaris Pump module. All sets are latex free and contain an integrated safety clamp fitment to help prevent accidental free flow. Configurations are available with integrated SmartSite needle-free valves and VersaSafe split septum ports.

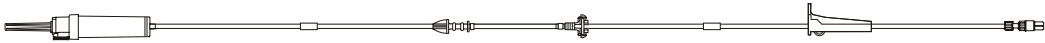





Model #	Drops	Description	Case quantity
2200-0500	20	 <p>Infusion set, 2-piece male luer lock</p> <p>Approximate set length: 109" 277 cm. approx.</p> <p>Approximate priming volume: 24 mL</p>	20
2204-0007	20	 <p>Infusion set, vented/non-vented, 2-piece male luer lock</p> <p>Approximate set length: 47" 119 cm. approx.</p> <p>Approximate priming volume: 14 mL</p>	 20
2941-0500	60	 <p>Infusion set, 2-piece male luer lock</p> <p>Approximate set length: 40" 102 cm. approx.</p> <p>Approximate priming volume: 13 mL</p>	20
2942-0500	20	 <p>Infusion set, 2-piece male luer lock</p> <p>Approximate set length: 40" 102 cm. approx.</p> <p>Approximate priming volume: 13 mL</p>	20
10942011		 <p>Infusion set, 2-piece male luer lock</p> <p>Approximate set length: 109" 277 cm. approx.</p> <p>Approximate priming volume: 23 mL</p>	 20
C24112		 <p>Infusion set, 2-piece male luer lock</p> <p>Approximate set length: 26" 66 cm. approx.</p> <p>Approximate priming volume: 4 mL</p>	50

06.00 Alaris Pump module

06.06.03 Primary administration sets | VersaSafe split septum sets

Administration sets for use with the Alaris Pump module. All sets are latex free and contain an integrated safety clamp fitment to help prevent accidental free flow. Configurations are available with integrated SmartSite needle-free valves and VersaSafe split septum ports.



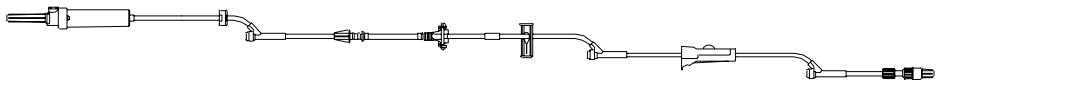
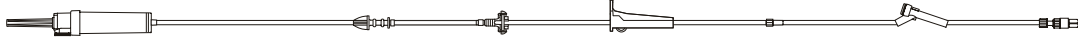







Model #	Drops	Description	Case quantity
2110-0500	20	 <p>Infusion set, 2 split septum ports 85" and 6" from 2-piece male luer lock</p> <p>Approximate set length: 115" 292 cm. approx.</p> <p>Approximate priming volume: 25 mL</p>	20
2111-0500	60	 <p>Infusion set, smallbore tubing segment, 2 split septum ports 86" and 7" from 2-piece male luer lock</p> <p>Approximate set length: 117" 297 cm. approx.</p> <p>Approximate priming volume: 19 mL</p>	20
2120-0500	20	 <p>Infusion set, check valve, 2 split septum ports 85" and 6" from 2-piece male luer lock</p> <p>Approximate set length: 117" 297 cm. approx.</p> <p>Approximate priming volume: 26 mL</p>	20
2126-0500	20	 <p>Infusion set, check valve, 3 split septum ports 83", 63" and 6" from 2-piece male luer lock</p> <p>Approximate set length: 107" 272 cm. approx.</p> <p>Approximate priming volume: 24 mL</p>	20
2129-0500	20	 <p>Infusion set, check valve, 3 split septum ports 81", 42", and 6" from 2-piece male luer lock</p> <p>Approximate set length: 110" 280 cm. approx.</p> <p>Approximate priming volume: 25 mL</p>	20
2929-0500	20	 <p>Infusion set, smallbore tubing segment, 1 split septum port 6" from 2-piece male luer lock</p> <p>Approximate set length: 149" 378 cm. approx.</p> <p>Approximate priming volume: 16 mL</p>	20

06.00 Alaris Pump module

06.06.03 Primary administration sets | VersaSafe split septum sets

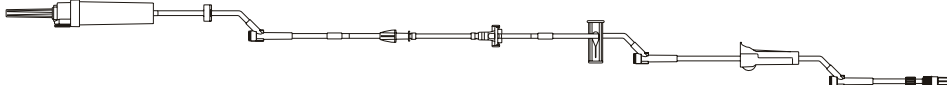
Administration sets for use with the Alaris Pump module. All sets are latex free and contain an integrated safety clamp fitment to help prevent accidental free flow. Configurations are available with integrated SmartSite needle-free valves and VersaSafe split septum ports.

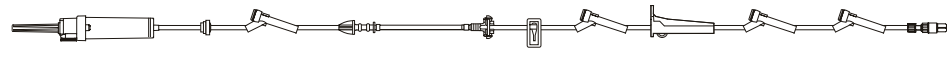

Model #	Drops	Description	Case quantity
2120-0007 30-day lead time	20	 Infusion set, vented/non-vented, check valve, 2 split septum ports 85" and 6" from 2-piece male luer lock Approximate set length: 118" 300 cm. approx. Approximate priming volume: 25 mL	 20
2121-0500 30-day lead time	20	 Infusion set, vented/non-vented, 0.2 micron (low-protein binding) filter, check valve, 1 split septum port 6" from 2-piece male luer lock Approximate set length: 115" 293 cm. approx. Approximate priming volume: 27 mL	 20
2126-0007	20	 Infusion set, vented/non-vented, check valve, 3 split septum port 83", 63" and 6" from 2-piece male luer lock Approximate set length: 107" 272 cm. approx. Approximate priming volume: 23 mL	 20
10011462	60	 Infusion set, check valve, 4 split septum ports 97", 79", 36" and 6" from 2-piece male luer lock Approximate set length: 124" 315 cm. approx. Approximate priming volume: 27 mL	20
11147991	20	 Infusion set, 1 split septum port 12" from 2-piece male luer lock Approximate set length: 55" 140 cm. approx. Approximate priming volume: 16 mL	20

06.00 Alaris Pump module

06.06.03 Primary administration sets | VersaSafe split septum sets

Administration sets for use with the Alaris Pump module. All sets are latex free and contain an integrated safety clamp fitment to help prevent accidental free flow. Configurations are available with integrated SmartSite needle-free valves and VersaSafe split septum ports.







Model #	Drops	Description	Case quantity
11258588		<p data-bbox="321 556 976 583">Infusion half set, 1 split septum port 6" from 2-piece male luer lock</p>	20
	Approximate set length: 86" 218 cm. approx.		
	Approximate priming volume: 13 mL		
11325478		<p data-bbox="321 821 1230 848">Infusion set, 2 check valves, 3 split septum ports 80", 44" and 6" from 2-piece male luer lock</p>	20
	Approximate set length: 109" 277 cm. approx.		
	Approximate priming volume: 25 mL		

07.00 Alaris Syringe module

07.01 Alaris Syringe module sets | With pressure sensing disc

Administration sets for use with the Alaris Syringe module. All sets are latex free. Configurations are available with the exclusive pressure sensing disc which enables the following Alaris Syringe module features: fast start, occlusion back off, numeric pressure display, auto-pressure and configurable pressure alarm settings. The Alaris Syringe module will accept non-dedicated administration sets, but we recommend using administration sets with the pressure sensing disc.











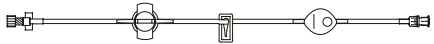

Model #	Drops	Description	Case quantity
30916-07		 <p>Syringe set, needle-free valve, microbore tubing, pressure-sensing disc, fixed male luer lock</p> <p>Approximate set length: 60" 152 cm. approx.</p> <p>Approximate priming volume: 0.8 mL</p>	 100
30920-07		 <p>Syringe set, needle-free valve, smallbore tubing, pressure-sensing disc, fixed male luer lock</p> <p>Approximate set length: 60" 152 cm. approx.</p> <p>Approximate priming volume: 1.5 mL</p>	 100
10014913		 <p>Microbore tubing, pressure sensing disc, fixed male luer lock</p> <p>Approximate set length: 36" 91 cm. approx.</p> <p>Approximate priming volume: 0.6 mL</p>	 100
10014914		 <p>Microbore tubing, pressure sensing disc, fixed male luer lock</p> <p>Approximate set length: 60" 152 cm. approx.</p> <p>Approximate priming volume: 0.8 mL</p>	 100
10014915		 <p>Microbore tubing, pressure sensing disc, 0.2 micron (low-protein binding) filter, fixed male luer lock</p> <p>Approximate set length: 36" 91 cm. approx.</p> <p>Approximate priming volume: 0.8 mL</p>	 100

07.00 Alaris Syringe module

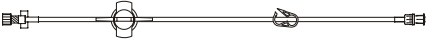
07.01 Alaris Syringe module sets | With pressure sensing disc

Administration sets for use with the Alaris Syringe module. All sets are latex free. Configurations are available with the exclusive pressure sensing disc which enables the following Alaris Syringe module features: fast start, occlusion back off, numeric pressure display, auto-pressure and configurable pressure alarm settings. The Alaris Syringe module will accept non-dedicated administration sets, but we recommend using administration sets with the pressure sensing disc.









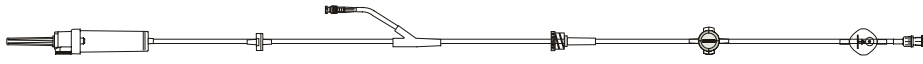

Model #	Drops	Description	Case quantity
10014916		 <p>Microbore tubing, pressure sensing disc, 0.2 micron (low-protein binding) filter, fixed male luer lock</p> <p>Approximate set length: 60" 152 cm. approx.</p> <p>Approximate priming volume: 1 mL</p>	 100
10014917		 <p>Smallbore tubing, pressure sensing disc, fixed male luer lock</p> <p>Approximate set length: 60" 152 cm. approx.</p> <p>Approximate priming volume: 1.7 mL</p>	 100
10014918		 <p>Microbore low sorbing tubing, pressure sensing disc, fixed male luer lock</p> <p>Approximate set length: 60" 152 cm. approx.</p> <p>Approximate priming volume: 1.3 mL</p>	 100
10015612		 <p>Microbore tubing, pressure sensing disc, fixed male luer lock</p> <p>Approximate set length: 78" 198 cm. approx.</p> <p>Approximate priming volume: 1 mL</p>	 100
10321214		 <p>Microbore tubing, pressure sensing disc, spin male luer lock</p> <p>Approximate set length: 79" 201 cm. approx.</p> <p>Approximate priming volume: 1 mL</p>	 100

07.00 Alaris Syringe module

07.01 Alaris Syringe module sets | With pressure sensing disc

Administration sets for use with the Alaris Syringe module. All sets are latex free. Configurations are available with the exclusive pressure sensing disc which enables the following Alaris Syringe module features: fast start, occlusion back off, numeric pressure display, auto-pressure and configurable pressure alarm settings. The Alaris Syringe module will accept non-dedicated administration sets, but we recommend using administration sets with the pressure sensing disc.

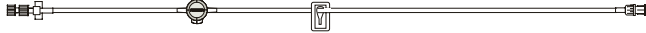

Model #	Drops	Description	Case quantity
10798696	20	 <p>Syringe set, microbore tubing, check valve, needle-free valve Y-extension, 0.2 micron (low-protein binding) filter, anti-siphon valve, pressure sensing disc, fixed male luer lock</p> <p>Approximate set length: 96" 244 cm. approx.</p> <p>Approximate priming volume: 14 mL</p>	 50
10798697		 <p>Microbore amber tubing, pressure sensing disc, spin male luer lock</p> <p>Approximate set length: 63" 160 cm. approx.</p> <p>Approximate priming volume: 0.8 mL</p>	 100
10798703	20	 <p>Syringe set, microbore tubing, check valve, needle-free valve Y-extension, anti-siphon valve, pressure sensing disc, fixed male luer lock</p> <p>Approximate set length: 96" 244 cm. approx.</p> <p>Approximate priming volume: 14 mL</p>	 50
10912433		 <p>Microbore tubing, pressure sensing disc, spin male luer lock</p> <p>Approximate set length: 47" 119 cm. approx.</p> <p>Approximate priming volume: 0.7 mL</p>	 100

30-day lead time

07.00 Alaris Syringe module

07.02 Alaris Syringe module sets | Without pressure sensing disc

Administration sets for use with the Alaris Syringe module. All sets are latex free. Configurations are available with the exclusive pressure sensing disc which enables the following Alaris Syringe module features: fast start, occlusion back off, numeric pressure display, auto-pressure and configurable pressure alarm settings. The Alaris Syringe module will accept non-dedicated administration sets, but we recommend using administration sets with the pressure sensing disc.



Model #	Drops	Description	Case quantity
---------	-------	-------------	---------------

10689602

20

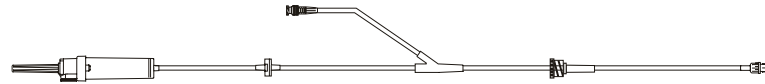

Syringe set, microbore tubing, check valve, needle-free valve
Y-extension, anti-siphon valve, fixed male luer lock

Approximate set length: 95" 241 cm. approx.

Approximate priming volume: 14 mL









50

08.00 Alaris PCA module

08.00 Alaris PCA module sets

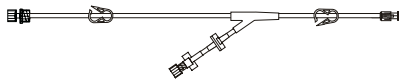
The Alaris PCA module uses standard, single-use, disposable syringes (with luer-lock connectors) and administration sets with anti-siphon valves, designed for use on syringe-type PCA pumps. The following extension and administration sets are compatible with the Alaris PCA module. All sets are latex free.













Model #	Drops	Description	Case quantity
30843E		 <p>PCA extension set, smallbore tubing segment, check valve, 1 needle-free valve 7" from 2-piece male luer lock</p> <p>Approximate set length: 13" 33 cm. approx. Approximate priming volume: 1 mL</p>	 100
30853		 <p>Administration set, Y-connector, 2 female luer lock ports, anti-siphon valve, check valve, microbore tubing segment, fixed male luer lock</p> <p>Approximate set length: 70" 178 cm. approx. Approximate priming volume: 2.8 mL</p>	 50
30863	30-day lead time	 <p>Microbore administration set, anti-siphon valve, fixed male luer lock</p> <p>Approximate set length: 62" 157 cm. approx. Approximate priming volume: 1.5 mL</p>	 50
30873		 <p>Administration set, Y-connector, 2 female luer locks, anti-siphon valve, check valve, microbore tubing segment, fixed male luer lock</p> <p>Approximate set length: 93" 236 cm. approx. Approximate priming volume: 3 mL</p>	 50

08.00 Alaris PCA module

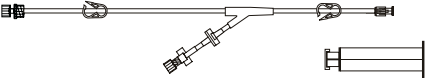
08.00 Alaris PCA module sets

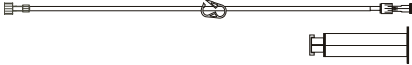
The Alaris PCA module uses standard, single-use, disposable syringes (with luer-lock connectors) and administration sets with anti-siphon valves, designed for use on syringe-type PCA pumps. The following extension and administration sets are compatible with the Alaris PCA module. All sets are latex free.

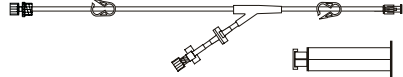











Model #	Drops	Description	Case quantity
30883		 <p>Microbore administration set, anti-siphon valve, fixed male luer lock</p> <p>Approximate set length: 92" 234 cm. approx.</p> <p>Approximate priming volume: 2.1 mL</p>	 50
30893		 <p>Microbore administration set with yellow identification stripe, anti-siphon valve, fixed male luer lock</p> <p>Approximate set length: 112" 284 cm. approx.</p> <p>Approximate priming volume: 2.7 mL</p>	 50
10800173		 <p>Administration set, Y-connector, 2 female luer locks, anti-siphon valve, check valve, microbore tubing segment, fixed male luer lock with reusable plunger</p> <p>Approximate set length: 70" 178 cm. approx.</p> <p>Approximate priming volume: 2.8 mL</p>	 50
10800174	30-day lead time	 <p>Administration set, anti-siphon valve, microbore tubing segment, fixed male luer lock with reusable plunger</p> <p>Approximate set length: 62" 157 cm. approx.</p> <p>Approximate priming volume: 1.6 mL</p>	 50
10800175		 <p>Administration set, Y-connector, 2 female luer locks, anti-siphon valve, check valve, microbore tubing segment, fixed male luer lock with reusable plunger</p> <p>Approximate set length: 90" 229 cm. approx.</p> <p>Approximate priming volume: 4 mL</p>	 50

08.00 Alaris PCA module

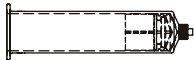
08.00 Alaris PCA module sets

The Alaris PCA module uses standard, single-use, disposable syringes (with luer-lock connectors) and administration sets with anti-siphon valves, designed for use on syringe-type PCA pumps. The following extension and administration sets are compatible with the Alaris PCA module. All sets are latex free.



Model #	Drops	Description	Case quantity
10800176		 <p>Microbore administration set, anti-siphon valve, fixed male luer lock with reusable plunger</p> <p>Approximate set length: 92" 234 cm. approx.</p> <p>Approximate priming volume: 2.1 mL</p>	 50
10800177		 <p>Microbore administration set with yellow identification stripe, anti-siphon valve, fixed male luer lock with reusable plunger</p> <p>Approximate set length: 112" 284 cm. approx.</p> <p>Approximate priming volume: 2.8 mL</p>	 50
8881135609		 <p>Empty 35mL Monoject syringe barrel. 10/pack</p>	 150
8881682101		 <p>Monoject syringe barrel tip cap. 10/pack</p>	 1000
8881682119		 <p>Monoject syringe barrel tip cap. 25/pack</p>	 1000

09.00 Alaris SE pump

09.01.01 Burettes | SmartSite valve sets

Administration sets for use with Alaris SE pumps. All sets are latex free and contain the AccuSlide® flow regulator, which replaces the roller clamp and minimizes the risk of accidental free flow. Set configurations are available with one or more of the SmartSite needle-free valves and VersaSafe split septum ports.

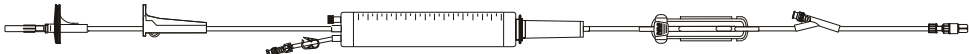
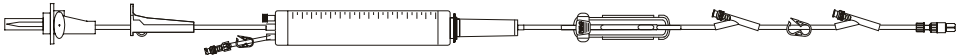
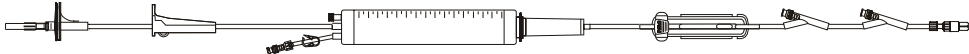
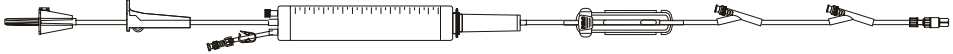

Model #	Drops	Description	Case quantity
72103E	20	 <p>Infusion set, 150 mL burette (needle-free valve), 1 needle-free valve 9" from 2-piece male luer lock</p> <p>Approximate set length: 120" 305 cm. approx.</p> <p>Approximate priming volume: 22 mL</p>	20
72104KE	20	 <p>Infusion set, 150 mL burette (needle-free valve), 2 needle-free valves 62" and 9" from 2-piece male luer lock</p> <p>Approximate set length: 122" 310 cm. approx.</p> <p>Approximate priming volume: 22 mL</p>	20
72163E	60	 <p>Infusion set, 150 mL burette (needle-free valve), smallbore tubing segment, 2 needle-free valves 60" and 9" from 2-piece male luer lock</p> <p>Approximate set length: 122" 310 cm. approx.</p> <p>Approximate priming volume: 16 mL</p>	20
72163E-0003	60	 <p>Infusion set, 150 mL burette (needle-free valve), hat valve in bag spike, smallbore tubing segment, 2 needle-free valves 60" and 9" from spin male luer.</p> <p>Approximate set length: 122" 310 cm. approx.</p> <p>Approximate priming volume: 17 mL</p>	20

09.00 Alaris SE pump

09.01.01 Burettes | SmartSite valve sets

Administration sets for use with Alaris SE pumps. All sets are latex free and contain the AccuSlide flow regulator, which replaces the roller clamp and minimizes the risk of accidental free flow. Set configurations are available with one or more of the SmartSite needle-free valves and VersaSafe split septum ports.



Model #	Drops	Description	Case quantity
---------	-------	-------------	---------------

72165E

60

30-day lead time

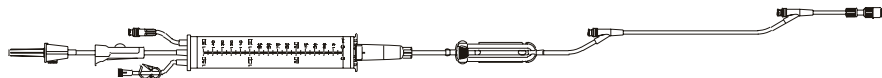

Infusion set, burette (needle-free valve), 2 needle-free valves 61" and 9" from 2-piece male luer lock

Approximate set length: 122" 304 cm. approx.

Approximate priming volume: 18 mL



20

72193E

60

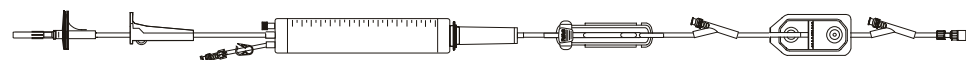

Infusion set, 150 mL burette (needle-free valve), smallbore tubing segment, 0.2 micron (low-protein binding) filter, 2 needle-free valves 62" and 9" from 2-piece male luer lock

Approximate set length: 123" 312 cm. approx.

Approximate priming volume: 20 mL

20

C72110E

60

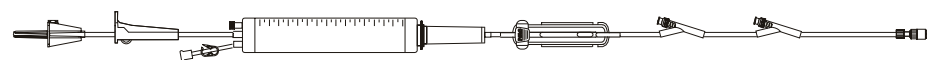

Infusion set, 150 mL burette (needle-free valve), smallbore tubing segment, 2 needle-free valves 83" and 9" from 2-piece male luer lock

Approximate set length: 143" 363 cm. approx.

Approximate priming volume: 19 mL

20

C72113E

60

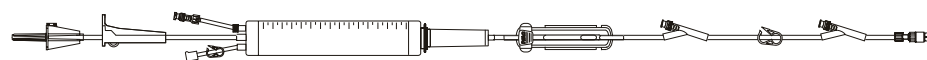

Infusion set, 150 mL burette (needle-free valve), smallbore tubing segment, 2 needle-free valves 62" and 9" from 2-piece male luer lock

Approximate set length: 121" 307 cm. approx.

Approximate priming volume: 17 mL



20

09.00 Alaris SE pump

09.01.02 Burettes | VersaSafe split septum sets

Administration sets for use with Alaris SE pumps. All sets are latex free and contain the AccuSlide flow regulator, which replaces the roller clamp and minimizes the risk of accidental free flow. Set configurations are available with one or more of the SmartSite needle-free valves and VersaSafe split septum ports.

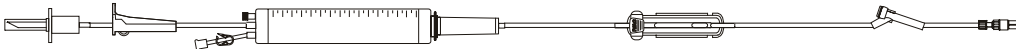
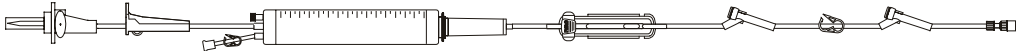
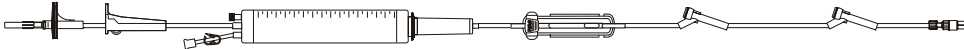
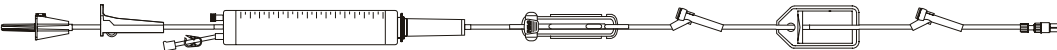

Model #	Drops	Description	Case quantity
72103M	20	 <p>Infusion set, 150 mL burette (split septum port), 1 split septum port 9" from 2-piece male luer lock</p> <p>Approximate set length: 121" 307 cm. approx.</p> <p>Approximate priming volume: 22 mL</p>	20
72104KM	20	 <p>Infusion set, 150 mL burette (split septum port), 2 split septum ports 63" and 9" from 2-piece male luer lock</p> <p>Approximate set length: 122" 310 cm. approx.</p> <p>Approximate priming volume: 23 mL</p>	20
72163M	60	 <p>Infusion set, 150 mL burette (needle-free valve), smallbore tubing segment, 2 split septum ports 63" and 9" from 2-piece male luer lock</p> <p>Approximate set length: 122" 310 cm. approx.</p> <p>Approximate priming volume: 18 mL</p>	20
11141556	60	 <p>Infusion set, 150 mL burette (split septum port), smallbore tubing segment, 0.2 micron (low-protein binding) filter, 2 split septum ports 60" and 9" from 2-piece male luer lock</p> <p>Approximate set length: 124" 315 cm. approx.</p> <p>Approximate priming volume: 21 mL</p>	 20

09.00 Alaris SE pump

09.02.01 Low sorbing tubing | SmartSite valve sets

Administration sets for use with Alaris SE pumps. All sets are latex free and contain the AccuSlide flow regulator, which replaces the roller clamp and minimizes the risk of accidental free flow. Set configurations are available with one or more of the SmartSite needle-free valves and VersaSafe split septum ports.



Model #	Drops	Description	Case quantity
---------	-------	-------------	---------------

72313E



30-day lead time



Infusion set, low sorbing tubing segment, 1.2 micron (low-protein binding) filter, 1 needle-free valve 9" from 2-piece male luer lock

50

Approximate set length: 118" 300 cm. approx.

Approximate priming volume: 26 mL

72923E

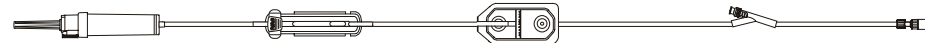

Infusion set, low sorbing tubing segment, 0.2 micron (low-protein binding) filter, 1 needle-free valve 9" from 2-piece male luer lock

50

Approximate set length: 119" 302 cm. approx.

Approximate priming volume: 26 mL

10015863



30-day lead time

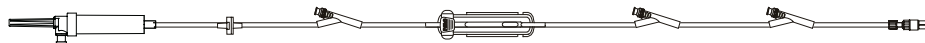

Infusion set, low sorbing tubing segment, non-vented, needle-free valve bag access port, check valve, 3 needle-free valves 83", 37" and 9" from 2-piece male luer lock

50

Approximate set length: 101" 257 cm. approx.





Approximate priming volume: 22 mL

09.00 Alaris SE pump

09.02.02 Low sorbing tubing | No port sets

Administration sets for use with Alaris SE pumps. All sets are latex free and contain the AccuSlide flow regulator, which replaces the roller clamp and minimizes the risk of accidental free flow. Set configurations are available with one or more of the SmartSite needle-free valves and VersaSafe split septum ports.



Model #	Drops	Description	Case quantity
72923	20	 <p>Infusion set, low sorbing tubing segment, 0.2 micron (low-protein binding) filter, 2-piece male luer lock</p> <p>Approximate set length: 104" 264 cm. approx.</p> <p>Approximate priming volume: 24 mL</p>	50
72953	20	 <p>Infusion set, low sorbing tubing segment, 2-piece male luer lock</p> <p>Approximate set length: 110" 279 cm. approx.</p> <p>Approximate priming volume: 22 mL</p>	20
10026645		 <p>Infusion set, low sorbing tubing segment, non-vented, needle-free valve bag access port, 2-piece male luer lock</p> <p>Approximate set length: 88" 224 cm. approx.</p> <p>Approximate priming volume: 20 mL</p>	20
10784614	20	 <p>Infusion set, low sorbing tubing segment, non-vented, needle-free valve bag access port, spin male luer lock</p> <p>Approximate set length: 88" 224 cm. approx.</p> <p>Approximate priming volume: 20 mL</p>	20
11258587	20	 <p>Infusion set, low sorbing tubing segment, 2-piece male luer lock</p> <p>Approximate set length: 111" 282 cm. approx.</p> <p>Approximate priming volume: 23 mL</p>	20



09.00 Alaris SE pump

09.03.01.01 Filters | Blood filters | SmartSite valve sets

Administration sets for use with Alaris SE pumps. All sets are latex free and contain the AccuSlide flow regulator, which replaces the roller clamp and minimizes the risk of accidental free flow. Set configurations are available with one or more of the SmartSite needle-free valves and VersaSafe split septum ports.

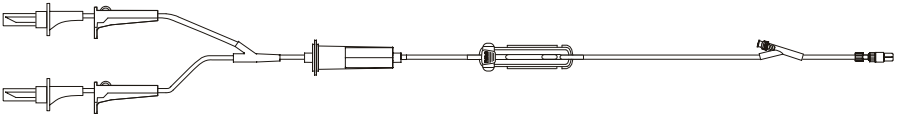
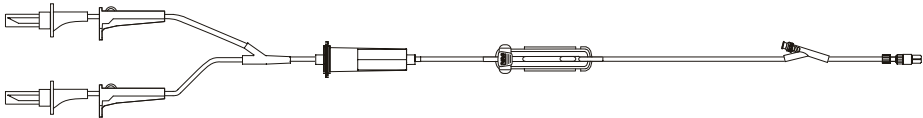
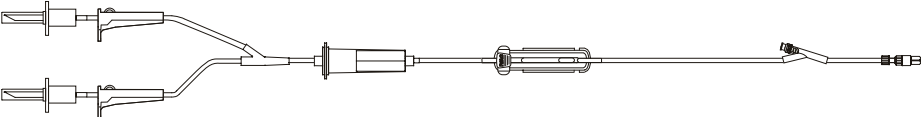

Model #	Drops	Description	Case quantity
72980E	15	 <p>Non-vented blood set, 180 micron filter, 1 needle-free valve 9" from 2-piece male luer lock</p> <p>Approximate set length: 105" 267 cm. approx.</p> <p>Approximate priming volume: 31 mL</p>	20
72981E	20	 <p>Non-vented blood set, 200 micron filter, 1 needle-free valve 62" from 2-piece male luer lock</p> <p>Approximate set length: 106" 269 cm. approx.</p> <p>Approximate priming volume: 31 mL</p>	20
79980E	20	 <p>Non-vented blood set, blunt short spike, 200 micron filter, 1 needle-free valve 59" from 2-piece male luer lock</p> <p>Approximate set length: 106" 269 cm. approx.</p> <p>Approximate priming volume: 30 mL</p>	20

09.00 Alaris SE pump

09.03.01.02 Filters | Blood filters | No port sets

Administration sets for use with Alaris SE pumps. All sets are latex free and contain the AccuSlide flow regulator, which replaces the roller clamp and minimizes the risk of accidental free flow. Set configurations are available with one or more of the SmartSite needle-free valves and VersaSafe split septum ports.



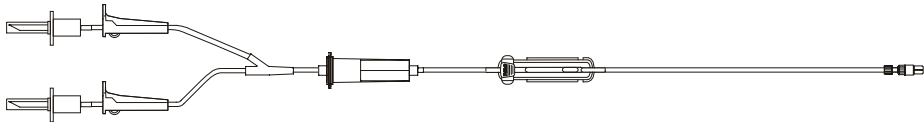

Model #	Drops	Description	Case quantity
71980-0500	20	 <p>Non-vented blood set with single spike, 200 micron filter, smallbore tubing segment, 2-piece male luer lock</p> <p>Approximate set length: 108" 274 cm. approx.</p> <p>Approximate priming volume: 21 mL</p>	50
10015415	15	 <p>Non-vented blood set, 180 micron filter, 2-piece male luer lock</p> <p>Approximate set length: 104" 264 cm. approx.</p> <p>Approximate priming volume: 31 mL</p>	20

09.00 Alaris SE pump

09.03.01.03 Filters | Blood filters | VersaSafe split septum sets

Administration sets for use with Alaris SE pumps. All sets are latex free and contain the AccuSlide flow regulator, which replaces the roller clamp and minimizes the risk of accidental free flow. Set configurations are available with one or more of the SmartSite needle-free valves and VersaSafe split septum ports.

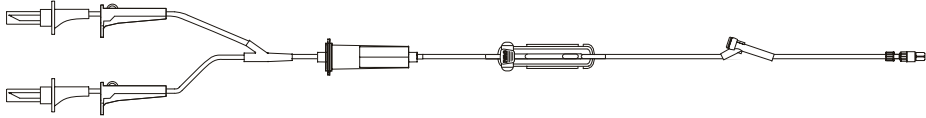
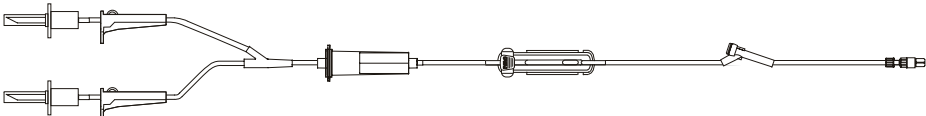
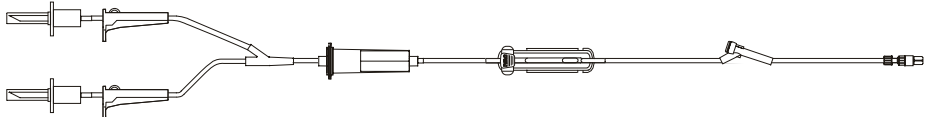





Model #	Drops	Description	Case quantity
72980M	15	 <p>Non-vented blood set, 180 micron filter, 1 split septum port 9" from 2-piece male luer lock</p> <p>Approximate set length: 106" 269 cm. approx. Approximate priming volume: 31 mL</p>	20
10012212	20	 <p>Non-vented blood set, 200 micron filter, 1 split septum port 9" from 2-piece male luer lock</p> <p>Approximate set length: 106" 269 cm. approx. Approximate priming volume: 31 mL</p>	20
11499817	15	 <p>Non-vented blood set, 180 micron filter, 1 split septum port 9" from 2-piece male luer lock</p> <p>Approximate set length: 106" 269 cm. approx. Approximate priming volume: 31 mL</p>	 20

09.00 Alaris SE pump

09.03.02.01 Filters | 0.2 micron filters | SmartSite valve sets

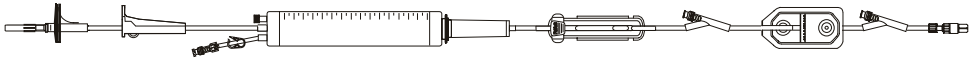
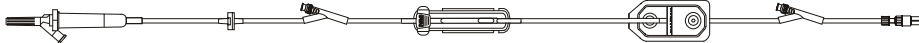
Administration sets for use with Alaris SE pumps. All sets are latex free and contain the AccuSlide flow regulator, which replaces the roller clamp and minimizes the risk of accidental free flow. Set configurations are available with one or more of the SmartSite needle-free valves and VersaSafe split septum ports.

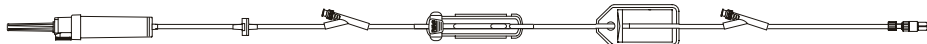



Model #	Drops	Description	Case quantity
72193E	60	 <p>Infusion set, 150 mL burette (needle-free valve), smallbore tubing segment, 0.2 micron (low-protein binding) filter, 2 needle-free valves 62" and 9" from 2-piece male luer lock</p> <p>Approximate set length: 123" 312 cm. approx.</p> <p>Approximate priming volume: 20 mL</p>	20
72323E	20	 <p>Infusion set, check valve, 0.2 micron (low-protein binding) filter, 2 needle-free valves 83" and 9" from 2-piece male luer lock</p> <p>Approximate set length: 100" 254 cm. approx.</p> <p>Approximate priming volume: 25 mL</p>	50
10014854 30-day lead time	20	 <p>Infusion set, 0.2 micron (low-protein binding) filter, 1 needle-free valve 9" from 2-piece male luer lock</p> <p>Approximate set length: 101" 257 cm. approx.</p> <p>Approximate priming volume: 25 mL</p>	50
11225954 30-day lead time	20	 <p>Infusion set, check valve, 0.2 micron (low-protein binding) filter, 2 needle-free valves 83" and 9" from 2-piece male luer lock</p> <p>Approximate set length: 100" 254 cm. approx.</p> <p>Approximate priming volume: 25 mL</p>	 50

09.00 Alaris SE pump

09.03.02.02 Filters | 0.2 micron filters | No port sets

Administration sets for use with Alaris SE pumps. All sets are latex free and contain the AccuSlide flow regulator, which replaces the roller clamp and minimizes the risk of accidental free flow. Set configurations are available with one or more of the SmartSite needle-free valves and VersaSafe split septum ports.



Model #	Drops	Description	Case quantity
72923		 <p data-bbox="321 556 1101 619">Infusion set, low sorbing tubing segment, 0.2 micron (low-protein binding) filter, 2-piece male luer lock</p> <p data-bbox="321 640 1003 667">Approximate set length: 104" 264 cm. approx.</p> <p data-bbox="321 678 727 705">Approximate priming volume: 24 mL</p>	50

09.00 Alaris SE pump

09.03.02.03 Filters | 0.2 micron filters | VersaSafe split septum sets

Administration sets for use with Alaris SE pumps. All sets are latex free and contain the AccuSlide flow regulator, which replaces the roller clamp and minimizes the risk of accidental free flow. Set configurations are available with one or more of the SmartSite needle-free valves and VersaSafe split septum ports.



Model #	Drops	Description	Case quantity
---------	-------	-------------	---------------

72323M

20

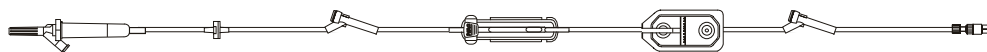

Infusion set, check valve, 0.2 micron (low-protein binding) filter, 2 split septum ports
73" and 9" from 2-piece male luer lock

50

Approximate set length: 100" 254 cm. approx.

Approximate priming volume: 25 mL

11141556

60

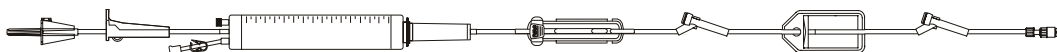

Infusion set, 150 mL burette (split septum port), smallbore tubing segment,
0.2 micron (low-protein binding) filter, 2 split septum ports 60" and 9" from
2-piece male luer lock



20

Approximate set length: 124" 315 cm. approx.

Approximate priming volume: 21 mL

09.00 Alaris SE pump

09.03.03.01 Filters | 1.2 micron filters | SmartSite valve sets

Administration sets for use with Alaris SE pumps. All sets are latex free and contain the AccuSlide flow regulator, which replaces the roller clamp and minimizes the risk of accidental free flow. Set configurations are available with one or more of the SmartSite needle-free valves and VersaSafe split septum ports.



Model #	Drops	Description	Case quantity
---------	-------	-------------	---------------

72313E

20

30-day lead time

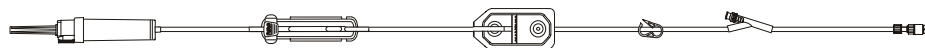

Infusion set, low sorbing tubing segment, 1.2 micron (low-protein binding) filter,
1 needle-free valve 9" from 2-piece male luer lock

50

Approximate set length: 118" 300 cm. approx.

Approximate priming volume: 26 mL

09.00 Alaris SE pump

09.03.03.02 Filters | 1.2 micron filters | VersaSafe split septum sets

Administration sets for use with Alaris SE pumps. All sets are latex free and contain the AccuSlide flow regulator, which replaces the roller clamp and minimizes the risk of accidental free flow. Set configurations are available with one or more of the SmartSite needle-free valves and VersaSafe split septum ports.



Model #	Drops	Description	Case quantity
---------	-------	-------------	---------------

11132982

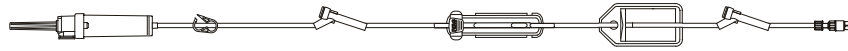

Infusion set, 1.2 micron (low-protein binding) filter, 2 split septum ports
87" and 9" from 2-piece male luer lock

Approximate set length: 105" 267 cm. approx.

Approximate priming volume: 26 mL



50

09.00 Alaris SE pump

09.03.04.01 Filters | 15 micron filters | No port sets

Administration sets for use with Alaris SE pumps. All sets are latex free and contain the AccuSlide flow regulator, which replaces the roller clamp and minimizes the risk of accidental free flow. Set configurations are available with one or more of the SmartSite needle-free valves and VersaSafe split septum ports.



Model #	Drops	Description	Case quantity
---------	-------	-------------	---------------

72303-0500

20

30-day lead time



Infusion set, 15 micron filter (drip chamber), 2-piece male luer lock

50

Approximate set length: 96" 244 cm. approx.

Approximate priming volume: 20 mL

72544

20



Infusion set, amber tubing, 15 micron filter (drip chamber), fixed male luer lock

20

Approximate set length: 108" 274 cm. approx.

Approximate priming volume: 24 mL

10012529

20



Infusion set, amber tubing, 15 micron filter (drip chamber), 2-piece male luer lock

50

Approximate set length: 86" 218 cm. approx.



Approximate priming volume: 20 mL

09.00 Alaris SE pump

09.04.01 Special applications | Yellow striped tubing sets

Administration sets for use with Alaris SE pumps. All sets are latex free and contain the AccuSlide flow regulator, which replaces the roller clamp and minimizes the risk of accidental free flow. Set configurations are available with one or more of the SmartSite needle-free valves and VersaSafe split septum ports.





Model #	Drops	Description	Case quantity
10012812	 20	 Infusion set, microbore yellow striped tubing, 2-piece male luer lock	50
30-day lead time		Approximate set length: 100" 254 cm. approx. Approximate priming volume: 12 mL	

09.00 Alaris SE pump

09.04.02 Special applications | Amber tubing sets

Administration sets for use with Alaris SE pumps. All sets are latex free and contain the AccuSlide flow regulator, which replaces the roller clamp and minimizes the risk of accidental free flow. Set configurations are available with one or more of the SmartSite needle-free valves and VersaSafe split septum ports.





Model #	Drops	Description	Case quantity
72544	20	 <p data-bbox="321 556 889 621">Infusion set, amber tubing, 15 micron filter (drip chamber), fixed male luer lock</p> <p data-bbox="321 638 1003 665">Approximate set length: 108" 274 cm. approx.</p> <p data-bbox="321 678 724 705">Approximate priming volume: 24 mL</p>	20
10012529	20	 <p data-bbox="321 863 889 928">Infusion set, amber tubing, 15 micron filter (drip chamber), 2-piece male luer lock</p> <p data-bbox="321 945 1003 972">Approximate set length: 86" 218 cm. approx.</p> <p data-bbox="321 984 724 1012">Approximate priming volume: 20 mL</p>	50

09.00 Alaris SE pump

09.04.03 Special applications | SmartSite bag access port sets

Administration sets for use with Alaris SE pumps. All sets are latex free and contain the AccuSlide flow regulator, which replaces the roller clamp and minimizes the risk of accidental free flow. Set configurations are available with one or more of the SmartSite needle-free valves and VersaSafe split septum ports.

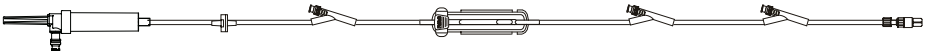

Model #	Drops	Description	Case quantity
10013363	20	 <p>Infusion set, non-vented, needle-free valve bag access port, smallbore tubing segment, check valve, 2 needle-free valves 90" and 9" from 2-piece male luer lock</p> <p>Approximate set length: 100" 254 cm. approx.</p> <p>Approximate priming volume: 22 mL</p>	50
10015863	20	 <p>Infusion set, low sorbing tubing segment, non-vented, needle-free valve bag access port, check valve, 3 needle-free valves 83", 37" and 9" from 2-piece male luer lock</p> <p>Approximate set length: 101" 257 cm. approx.</p> <p>Approximate priming volume: 22 mL</p>	50
10026645	20	 <p>Infusion set, low sorbing tubing segment, non-vented, needle-free valve bag access port, 2-piece male luer lock</p> <p>Approximate set length: 88" 224 cm. approx.</p> <p>Approximate priming volume: 20 mL</p>	20
10784614	20	 <p>Infusion set, low sorbing tubing segment, non-vented, needle-free valve bag access port, spin male luer lock</p> <p>Approximate set length: 88" 224 cm. approx.</p> <p>Approximate priming volume: 20 mL</p>	20

09.00 Alaris SE pump

09.04.04 Special applications | Syringe adapter sets

Administration sets for use with Alaris SE pumps. All sets are latex free and contain the AccuSlide flow regulator which replaces the roller clamp and minimizes the risk of accidental free flow. Set configurations are available with one or more of the SmartSite needle-free valves and VersaSafe split septum ports. Syringe clip holder 3011 available for use with Alaris SE pump syringe adapter sets.







Model #	Drops	Description	Case quantity
72983		 Syringe adapter set, microbore tubing, 2-piece male luer lock Approximate set length: 94" 239 cm. approx. Approximate priming volume: 3 mL	50

09.00 Alaris SE pump

09.05.01 Primary administration sets | SmartSite valve sets

Administration sets for use with Alaris SE pumps. All sets are latex free and contain the AccuSlide flow regulator, which replaces the roller clamp and minimizes the risk of accidental free flow. Set configurations are available with one or more of the SmartSite needle-free valves and VersaSafe split septum ports.

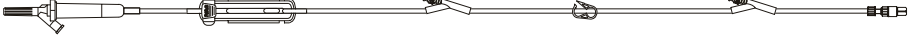

Model #	Drops	Description	Case quantity
71633E	10	 <p>Infusion set, check valve, 3 needle-free valves 99", 39" and 9" from 2-piece male luer lock</p> <p>Approximate set length: 138" 351 cm. approx.</p> <p>Approximate priming volume: 25 mL</p>	50
72001E	20	 <p>Infusion set, 1 needle-free valve 9" from 2-piece male luer lock</p> <p>Approximate set length: 102" 259 cm. approx.</p> <p>Approximate priming volume: 22 mL</p>	50
72013E	20	 <p>Infusion set, 2 needle-free valves 83" and 9" from 2-piece male luer lock</p> <p>Approximate set length: 102" 259 cm. approx.</p> <p>Approximate priming volume: 22 mL</p>	50
72013KE	20	 <p>Infusion set, 2 needle-free valves 68" and 9" from 2-piece male luer lock</p> <p>Approximate set length: 120" 305 cm. approx.</p> <p>Approximate priming volume: 25 mL</p>	50
72023E	20	 <p>Infusion set, check valve, 2 needle-free valves 83" and 9" from 2-piece male luer lock</p> <p>Approximate set length: 100" 254 cm. approx.</p> <p>Approximate priming volume: 22 mL</p>	50

09.00 Alaris SE pump

09.05.01 Primary administration sets | SmartSite valve sets

Administration sets for use with Alaris SE pumps. All sets are latex free and contain the AccuSlide flow regulator, which replaces the roller clamp and minimizes the risk of accidental free flow. Set configurations are available with one or more of the SmartSite needle-free valves and VersaSafe split septum ports.



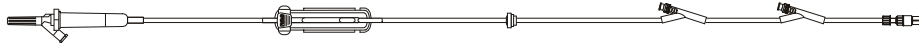
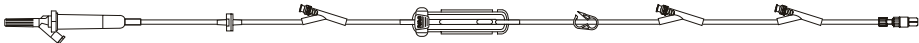
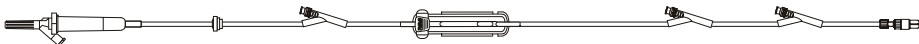
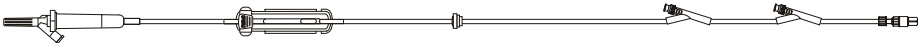
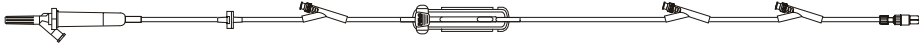



Model #	Drops	Description	Case quantity
72023KE	20	 <p>Infusion set, check valve, 2 needle-free valves 56" and 9" from 2-piece male luer lock</p> <p>Approximate set length: 118" 300 cm. approx.</p> <p>Approximate priming volume: 25 mL</p>	50
72033E	20	 <p>Infusion set, check valve, 3 needle-free valves 83", 39" and 9" from 2-piece male luer lock</p> <p>Approximate set length: 101" 257 cm. approx.</p> <p>Approximate priming volume: 22 mL</p>	50
72433E	60	 <p>Infusion set, check valve, 3 needle-free valves 83", 39" and 9" from 2-piece male luer lock</p> <p>Approximate set length: 102" 259 cm. approx.</p> <p>Approximate priming volume: 23 mL</p>	50
72623KE	60	 <p>Infusion set, check valve, 2 needle-free valves 67" and 9" from 2-piece male luer lock</p> <p>Approximate set length: 118" 300 cm. approx.</p> <p>Approximate priming volume: 25 mL</p>	50
30-day lead time			
72633E	20	 <p>Infusion set, check valve, 3 needle-free valves 119", 39" and 9" from 2-piece male luer lock</p> <p>Approximate set length: 138" 351 cm. approx.</p> <p>Approximate priming volume: 28 mL</p>	50

09.00 Alaris SE pump

09.05.01 Primary administration sets | SmartSite valve sets

Administration sets for use with Alaris SE pumps. All sets are latex free and contain the AccuSlide flow regulator, which replaces the roller clamp and minimizes the risk of accidental free flow. Set configurations are available with one or more of the SmartSite needle-free valves and VersaSafe split septum ports.



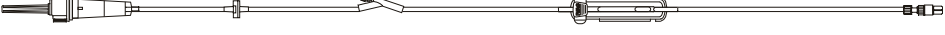

Model #	Drops	Description	Case quantity
72900E		 <p>Infusion half set, 1 needle-free valve 9" from 2-piece male luer lock Approximate set length: 85" 216 cm. approx. Approximate priming volume: 12 mL</p>	50
72963E	60	 <p>Infusion set, 2 needle-free valves 83" and 9" from 2-piece male luer lock Approximate set length: 103" 262 cm. approx. Approximate priming volume: 22 mL</p>	50
72964E	60	 <p>Infusion set, check valve, 2 needle-free valves 83" and 9" from spin male luer lock Approximate set length: 101" 257 cm. approx. Approximate priming volume: 23 mL</p>	50
10013182	20	 <p>Infusion set, check valve, 2 needle-free valves 83" and 9" from 2-piece male luer lock Approximate set length: 100" 254 cm. approx. Approximate priming volume: 22 mL</p>	 50
10942968	20	 <p>Infusion set, check valve, 1 needle-free valve 81" from 2-piece male luer lock Approximate set length: 99" 252 cm. approx. Approximate priming volume: 22 mL</p>	20

09.00 Alaris SE pump

09.05.01 Primary administration sets | SmartSite valve sets

Administration sets for use with Alaris SE pumps. All sets are latex free and contain the AccuSlide flow regulator, which replaces the roller clamp and minimizes the risk of accidental free flow. Set configurations are available with one or more of the SmartSite needle-free valves and VersaSafe split septum ports.

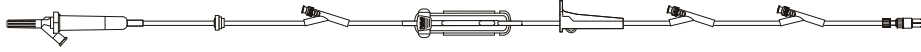
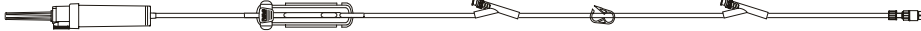





Model #	Drops	Description	Case quantity
C72102E 30-day lead time	10	 <p>Infusion set, check valve, 3 needle-free valves 83", 42" and 9" from 2-piece male luer lock</p> <p>Approximate set length: 112" 284 cm. approx.</p> <p>Approximate priming volume: 22 mL</p>	50
C72108E 30-day lead time	20	 <p>Infusion set, smallbore tubing segment, 2 needle-free valves 69" and 26" from 2-piece male luer lock</p> <p>Approximate set length: 107" 272 cm. approx.</p> <p>Approximate priming volume: 14 mL</p>	50
C72109E	20	 <p>Infusion set, check valve, 3 needle-free valves 121", 98" and 9" from 2-piece male luer lock</p> <p>Approximate set length: 138" 351 cm. approx.</p> <p>Approximate priming volume: 28 mL</p>	50

09.00 Alaris SE pump

09.05.02 Primary administration sets | No port sets

Administration sets for use with Alaris SE pumps. All sets are latex free and contain the AccuSlide flow regulator, which replaces the roller clamp and minimizes the risk of accidental free flow. Set configurations are available with one or more of the SmartSite needle-free valves and VersaSafe split septum ports.



Model #	Drops	Description	Case quantity
72003	20	 <p>Infusion set, 2-piece male luer lock</p> <p>Approximate set length: 86" 218 cm. approx.</p> <p>Approximate priming volume: 20 mL</p>	50
72943	20	 <p>Infusion set, smallbore tubing segment, 2-piece male luer lock</p> <p>Approximate set length: 100" 254 cm. approx.</p> <p>Approximate priming volume: 14 mL</p>	50
10657768	20	 <p>Infusion set, 1.2 micron (low-protein binding) filter, 2-piece male luer lock</p> <p>Approximate set length: 102" 259 cm. approx.</p> <p>Approximate priming volume: 25 mL</p>	20
C72101	20	 <p>Infusion set, 2-piece male luer lock</p> <p>Approximate set length: 136" 345 cm. approx.</p> <p>Approximate priming volume: 22 mL</p>	50

30-day lead time







30-day lead time

09.00 Alaris SE pump

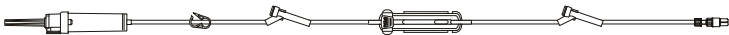
09.05.03 Primary administration sets | VersaSafe split septum sets

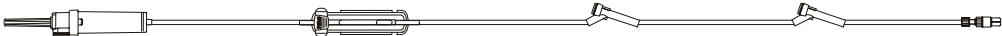
Administration sets for use with Alaris SE pumps. All sets are latex free and contain the AccuSlide flow regulator, which replaces the roller clamp and minimizes the risk of accidental free flow. Set configurations are available with one or more of the SmartSite needle-free valves and VersaSafe split septum ports.



Model #	Drops	Description	Case quantity
11325479	60	 <p>Infusion set, 2 split septum ports 83" and 9" from 2-piece male luer lock</p> <p>Approximate set length: 103" 262 cm. approx.</p> <p>Approximate priming volume: 23 mL</p>	 50
72012M	20	 <p>Infusion set, 2 split septum ports 56" and 9" from 2-piece male luer lock</p> <p>Approximate set length: 100" 254 cm. approx.</p> <p>Approximate priming volume: 22 mL</p>	50
72013KM	20	 <p>Infusion set, 2 split septum ports 55" and 6" from 2-piece male luer lock</p> <p>Approximate set length: 121" 307 cm. approx.</p> <p>Approximate priming volume: 25 mL</p>	50
30-day lead time			
72023M	20	 <p>Infusion set, check valve, 2 split septum ports 83" and 9" from 2-piece male luer lock</p> <p>Approximate set length: 102" 259 cm. approx.</p> <p>Approximate priming volume: 23 mL</p>	50
72033M	20	 <p>Infusion set, check valve, 3 split septum ports 83", 40" and 9" from 2-piece male luer lock</p> <p>Approximate set length: 103" 262 cm. approx.</p> <p>Approximate priming volume: 23 mL</p>	50

09.00 Alaris SE pump

09.05.03 Primary administration sets | VersaSafe split septum sets

Administration sets for use with Alaris SE pumps. All sets are latex free and contain the AccuSlide flow regulator, which replaces the roller clamp and minimizes the risk of accidental free flow. Set configurations are available with one or more of the SmartSite needle-free valves and VersaSafe split septum ports.



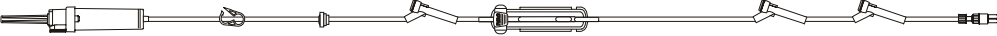
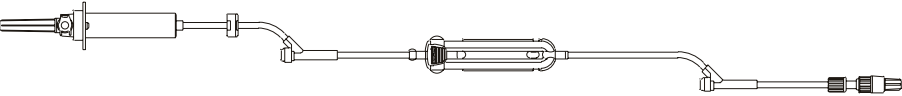
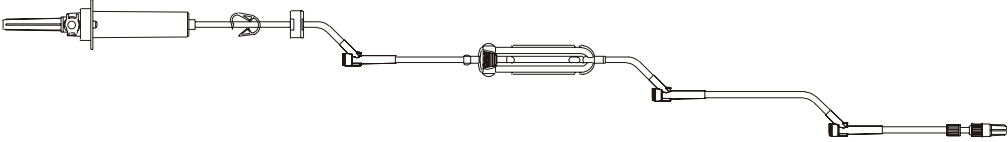

Model #	Drops	Description	Case quantity
72900M 30-day lead time		 <p>Infusion half set, 1 split septum port 9" from 2-piece male luer lock</p> <p>Approximate set length: 85" 216 cm. approx.</p> <p>Approximate priming volume: 13 mL</p>	50
10010721 20		 <p>Infusion set, check valve, 3 split septum ports 71", 58" and 6" from 2-piece male luer lock</p> <p>Approximate set length: 102" 259 cm. approx.</p> <p>Approximate priming volume: 23 mL</p>	50
11499816 20		 <p>Infusion set, check valve, 2 split septum ports 83" and 9" from 2-piece male luer lock</p> <p>Approximate set length: 102" 258 cm. approx.</p> <p>Approximate priming volume: 22 mL</p>	<div style="border: 1px solid black; border-radius: 50%; padding: 5px; display: inline-block;">DEHP</div> 50
11501182 20		 <p>Infusion set, check valve, Roberts clamp, 3 split septum ports 83", 62" and 9" from 2-piece male luer lock</p> <p>Approximate set length: 103" 261 cm. approx.</p> <p>Approximate priming volume: 23 mL</p>	<div style="border: 1px solid black; border-radius: 50%; padding: 5px; display: inline-block;">DEHP</div> 50

09.00 Alaris SE pump

09.05.03 Primary administration sets | VersaSafe split septum sets

Administration sets for use with Alaris SE pumps. All sets are latex free and contain the AccuSlide flow regulator, which replaces the roller clamp and minimizes the risk of accidental free flow. Set configurations are available with one or more of the SmartSite needle-free valves and VersaSafe split septum ports.

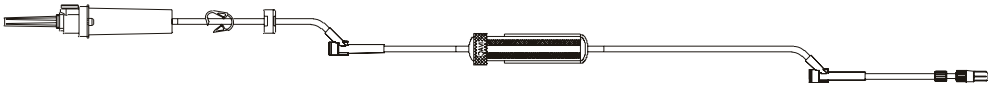

Model #	Drops	Description	Case quantity
11501183		 <p data-bbox="318 554 1154 663"> Infusion set, check valve, 2 split septum ports 83" and 9" from 2-piece male luer lock Approximate set length: 102" 258 cm. approx. Approximate priming volume: 23 mL </p>	 50

10.00 MedSystem III infusion pump

10.01.01 Burettes | SmartSite valve sets

Administration sets for use with the MedSystem III infusion pump. All sets are latex free and contain an integrated mechanism to help prevent accidental free flow. Set configurations are available with SmartSite needle-free valves and standard injection ports.

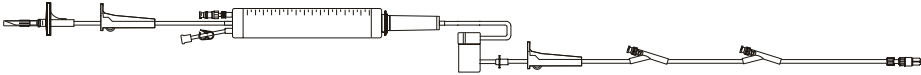

Model #	Drops	Description	Case quantity
28063E	60	 <p>Infusion set, 150 mL burette (needle-free valve), smallbore tubing segment, 2 needle-free valves 71" and 9" from 2-piece male luer lock</p> <p>Approximate set length: 122" 310 cm. approx.</p> <p>Approximate priming volume: 18 mL</p>	20

10.00 MedSystem III infusion pump

10.01.02 Burettes | Standard injection port sets

Administration sets for use with the MedSystem III infusion pump. All sets are latex free and contain an integrated mechanism to help prevent accidental free flow. Set configurations are available with SmartSite needle-free valves and standard injection ports.

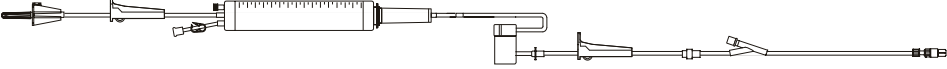
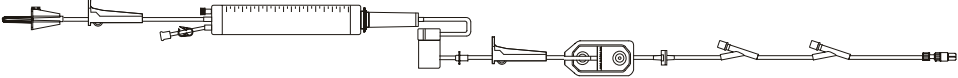

Model #	Drops	Description	Case quantity
28208	60	 <p>Infusion set, 150 mL burette (injection port), smallbore tubing segment, 1 injection port 9" from 2-piece male luer lock</p> <p>Approximate set length: 119" 302 cm. approx.</p> <p>Approximate priming volume: 18 mL</p>	20
28216	60	 <p>Infusion set, 150 mL burette (injection port), check valve, 0.2 micron (low-protein binding) filter, smallbore tubing segment, 2 injection ports 57" and 9" from 2-piece male luer lock</p> <p>Approximate set length: 122" 310 cm. approx.</p> <p>Approximate priming volume: 21 mL</p>	20

10.00 MedSystem III infusion pump

10.02.01 Low sorbing tubing | SmartSite valve sets

Administration sets for use with the MedSystem III infusion pump. All sets are latex free and contain an integrated mechanism to help prevent accidental free flow. Set configurations are available with SmartSite needle-free valves and standard injection ports.



Model #	Drops	Description	Case quantity
10011433	20	 Low sorbing infusion set, check valve, 2 needle-free valves 96" and 9" from 2-piece male luer lock Approximate set length: 115" 292 cm. approx. Approximate priming volume: 25 mL	50

10.00 MedSystem III infusion pump

10.02.02 Low sorbing tubing | No port sets

Administration sets for use with the MedSystem III infusion pump. All sets are latex free and contain an integrated mechanism to help prevent accidental free flow. Set configurations are available with SmartSite needle-free valves and standard injection ports.

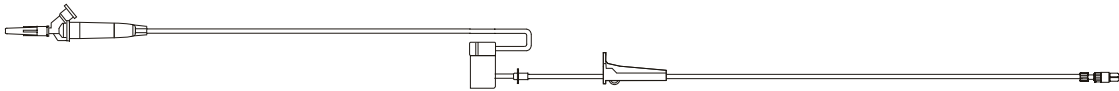

Model #	Drops	Description	Case quantity
28053	20	 Low sorbing infusion set, 2-piece male luer lock Approximate set length: 118" 300 cm. approx. Approximate priming volume: 24 mL	20

10.00 MedSystem III infusion pump

10.03.01.01 Filters | Blood filters | SmartSite valve sets

Administration sets for use with the MedSystem III infusion pump. All sets are latex free and contain an integrated mechanism to help prevent accidental free flow. Set configurations are available with SmartSite needle-free valves and standard injection ports.

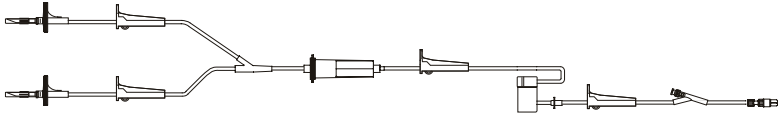

Model #	Drops	Description	Case quantity
28080E	20	 <p data-bbox="321 556 899 621">Non-vented blood set, 200 micron filter, 1 needle-free valve 9" from 2-piece male luer lock</p> <p data-bbox="321 638 1003 665">Approximate set length: 106" 269 cm. approx.</p> <p data-bbox="321 678 724 705">Approximate priming volume: 32 mL</p>	20

10.00 MedSystem III infusion pump

10.03.01.02 Filters | Blood filters | Standard injection port sets

Administration sets for use with the MedSystem III infusion pump. All sets are latex free and contain an integrated mechanism to help prevent accidental free flow. Set configurations are available with SmartSite needle-free valves and standard injection ports.

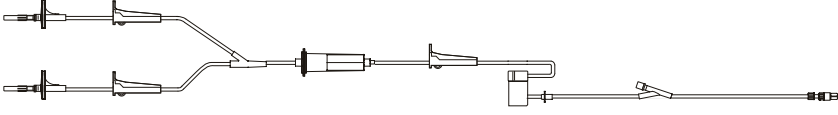

Model #	Drops	Description	Case quantity
28080	20	 <p data-bbox="321 556 862 621">Non-vented blood set, 200 micron filter, 1 injection port 9" from 2-piece male luer lock</p> <p data-bbox="321 638 1003 665">Approximate set length: 106" 269 cm. approx.</p> <p data-bbox="321 678 724 705">Approximate priming volume: 32 mL</p>	20

10.00 MedSystem III infusion pump

10.03.02.01 Filters | 0.2 micron filters | SmartSite valve sets

Administration sets for use with the MedSystem III infusion pump. All sets are latex free and contain an integrated mechanism to help prevent accidental free flow. Set configurations are available with SmartSite needle-free valves and standard injection ports.

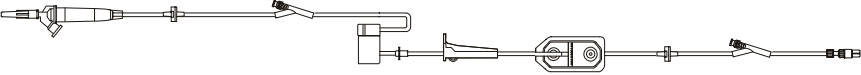

Model #	Drops	Description	Case quantity
28273E	60	 <p>Infusion set, smallbore tubing segment, 2 check valves, 0.2 micron (low-protein binding) filter, 2 needle-free valves 97" and 9" from 2-piece male luer lock</p> <p>Approximate set length: 114" 290 cm. approx.</p> <p>Approximate priming volume: 23 mL</p>	50

10.00 MedSystem III infusion pump

10.03.02.02 Filters | 0.2 micron filters | Standard injection port sets

Administration sets for use with the MedSystem III infusion pump. All sets are latex free and contain an integrated mechanism to help prevent accidental free flow. Set configurations are available with SmartSite needle-free valves and standard injection ports.

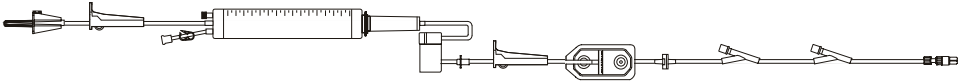

Model #	Drops	Description	Case quantity
28216	60	 <p data-bbox="313 554 954 657">Infusion set, 150 mL burette (injection port), check valve, 0.2 micron (low-protein binding) filter, smallbore tubing segment, 2 injection ports 57" and 9" from 2-piece male luer lock</p> <p data-bbox="313 680 1003 709">Approximate set length: 122" 310 cm. approx.</p> <p data-bbox="313 720 727 749">Approximate priming volume: 21 mL</p>	20

28216

60

30-day lead time

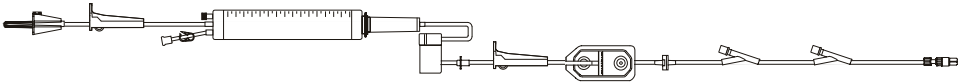

Infusion set, 150 mL burette (injection port), check valve, 0.2 micron (low-protein binding) filter, smallbore tubing segment, 2 injection ports 57" and 9" from 2-piece male luer lock

Approximate set length: 122" 310 cm. approx.

Approximate priming volume: 21 mL



20

10.00 MedSystem III infusion pump

10.04.01 Primary administration sets | SmartSite valve sets

Administration sets for use with the MedSystem III infusion pump. All sets are latex free and contain an integrated mechanism to help prevent accidental free flow. Set configurations are available with SmartSite needle-free valves and standard injection ports.

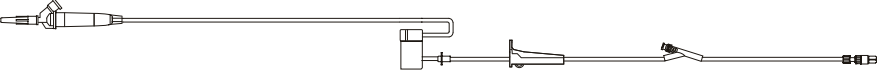
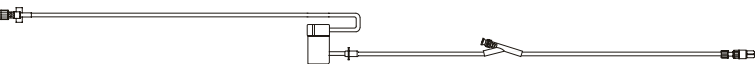

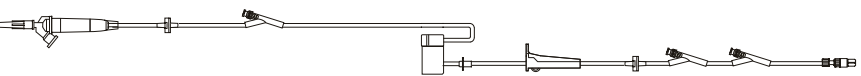
Model #	Drops	Description	Case quantity
28004E	20	 <p>Infusion set, 1 needle-free valve 9" from 2-piece male luer lock</p> <p>Approximate set length: 115" 292 cm. approx.</p> <p>Approximate priming volume: 25 mL</p>	50
28117E		 <p>Infusion half set, smallbore tubing segment, 1 needle-free valve 9" from 2-piece male luer lock</p> <p>Approximate set length: 86" 218 cm. approx.</p> <p>Approximate priming volume: 6 mL</p>	50
28293E	20	 <p>Infusion set, check valve, 2 needle-free valves 96" and 9" from 2-piece male luer lock</p> <p>Approximate set length: 118" 300 cm. approx.</p> <p>Approximate priming volume: 25 mL</p>	50
28493E	20	 <p>Infusion set, 2 check valves, 3 needle-free valves 101", 44" and 9" from 2-piece male luer lock</p> <p>Approximate set length: 118" 300 cm. approx.</p> <p>Approximate priming volume: 26 mL</p>	50

10.00 MedSystem III infusion pump

10.04.02 Primary administration sets | No port sets

Administration sets for use with the MedSystem III infusion pump. All sets are latex free and contain an integrated mechanism to help prevent accidental free flow. Set configurations are available with SmartSite needle-free valves and standard injection ports.

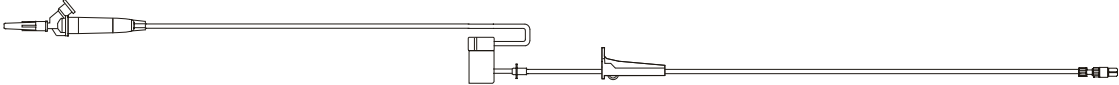
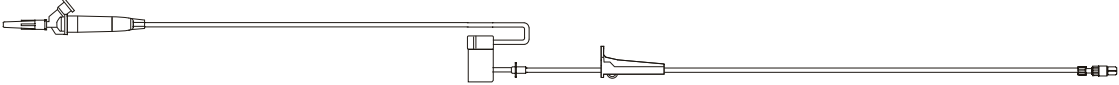
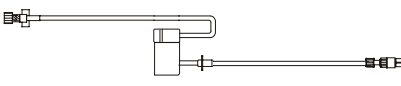

Model #	Drops	Description	Case quantity
28018	20	 <p>Infusion set, smallbore tubing segment, 2-piece male luer lock</p> <p>Approximate set length: 117" 297 cm. approx.</p> <p>Approximate priming volume: 25 mL</p>	50
28026	60	 <p>Infusion half set, smallbore tubing segment, 2-piece male luer lock</p> <p>Approximate set length: 116" 295 cm. approx.</p> <p>Approximate priming volume: 20 mL</p>	50
28125		 <p>Infusion half set, smallbore tubing segment, 2-piece male luer lock</p> <p>Approximate set length: 16" 41 cm. approx.</p> <p>Approximate priming volume: 2 mL</p>	50

30-day lead time

10.00 MedSystem III infusion pump

10.04.02 Primary administration sets | No port sets

Administration sets for use with the MedSystem III infusion pump. All sets are latex free and contain an integrated mechanism to help prevent accidental free flow. Set configurations are available with SmartSite needle-free valves and standard injection ports.

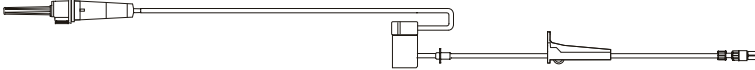

Model #	Drops	Description	Case quantity
11089893	20	 Infusion set, 2-piece male luer lock Approximate set length: 116" 295 cm. approx. Approximate priming volume: 25 mL	50

10.00 MedSystem III infusion pump

10.04.03 Primary administration sets | Standard injection port sets

Administration sets for use with the MedSystem III infusion pump. All sets are latex free and contain an integrated mechanism to help prevent accidental free flow. Set configurations are available with SmartSite needle-free valves and standard injection ports.



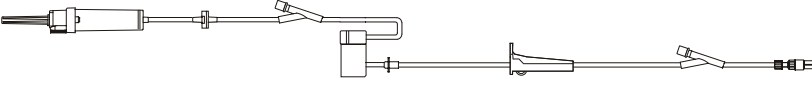
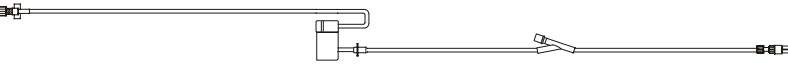
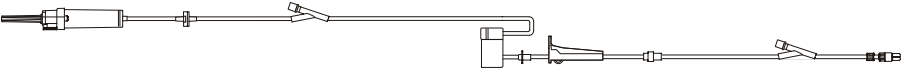

Model #	Drops	Description	Case quantity
28035-0500	20	 <p>Infusion set, check valve, 2 injection ports 100" and 9" from 2-piece male luer lock</p> <p>Approximate set length: 118" 299 cm. approx.</p> <p>Approximate priming volume: 26 mL</p>	50
28117		 <p>Infusion half set, smallbore tubing segment, 1 injection port 9" from 2-piece male luer lock</p> <p>Approximate set length: 86" 218 cm. approx.</p> <p>Approximate priming volume: 6 mL</p>	50
28265	60	 <p>Infusion set, smallbore tubing segment, check valve, 2 injection ports 96" and 9" from 2-piece male luer lock</p> <p>Approximate set length: 115" 292 cm. approx.</p> <p>Approximate priming volume: 20 mL</p>	50

11.00 Secondary administration sets

11.01.01 Filters | Blood filters | No port sets

Secondary sets provide access to primary infusion sets via MaxPlus needleless connectors and y-sites, SmartSite needle-free valves and VersaSafe split septum ports.

Model #	Drops	Description	Case quantity
10010985	20	 <p>Non-vented secondary blood set, 200 micron filter, 2-piece male luer lock</p> <p>Approximate set length: 33" 83 cm. approx.</p> <p>Approximate priming volume: 16 mL</p>	50
10014081	20	 <p>Non-vented secondary blood set, blunt short spike, 200 micron filter, 2-piece male luer lock</p> <p>Approximate set length: 32" 81 cm. approx.</p> <p>Approximate priming volume: 16 mL</p>	50
10016242	20	 <p>Non-vented secondary blood set, 200 micron filter, 2-piece male luer lock and hanger</p> <p>Approximate set length: 33" 84 cm. approx.</p> <p>Approximate priming volume: 16 mL</p>	50

11.00 Secondary administration sets

11.01.02 Filters | 15 micron filters | No port sets







Secondary sets provide access to primary infusion sets via MaxPlus needleless connectors and y-sites, SmartSite needle-free valves and VersaSafe split septum ports.

Model #	Drops	Description	Case quantity
C70101	20	 Vented/non-vented secondary set, 15 micron filter (drip chamber), 2-piece male luer lock Approximate set length: 37" 94 cm. approx. Approximate priming volume: 12 mL	30

11.00 Secondary administration sets

11.02.01 Special applications | SmartSite bag access port sets

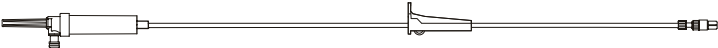
Secondary sets provide access to primary infusion sets via MaxPlus needleless connectors and y-sites, SmartSite needle-free valves and VersaSafe split septum ports.



Model #	Drops	Description	Case quantity
10013364	20	 <p>Non-vented secondary set, needle-free valve bag access port, fixed male luer lock and hanger</p> <p>Approximate set length: 32" 81 cm. approx.</p> <p>Approximate priming volume: 12 mL</p>	 100
10014881	20	 <p>Low sorbing non-vented secondary set, needle-free valve bag access port, fixed male luer lock and hanger</p> <p>Approximate set length: 31" 79 cm. approx.</p> <p>Approximate priming volume: 12 mL</p>	 100
11610341	20	 <p>Non-vented secondary set, needle-free valve bag access port, spin male luer lock and hanger</p> <p>Approximate set length: 31" 79 cm. approx.</p> <p>Approximate priming volume: 12 mL</p>	 100

30-day lead time

11.00 Secondary administration sets

11.02.02 Special applications | Bag access transfer sets

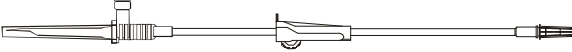

Secondary sets provide access to primary infusion sets via MaxPlus needleless connectors and y-sites, SmartSite needle-free valves and VersaSafe split septum ports.

Model #	Drops	Description	Case quantity
MT6000 30-day lead time		 <p>Secondary transfer set, vented bag access spike with cap, roller clamp, male luer slip</p> <p>Approximate set length: 22" 55.9 cm. approx.</p>	 50

11.00 Secondary administration sets

11.02.03 Special applications | Syringe adapter sets







Secondary sets provide access to primary infusion sets via MaxPlus needleless connectors and y-sites, SmartSite needle-free valves and VersaSafe split septum ports.

Model #	Drops	Description	Case quantity
10015501		 <p>Syringe adapter secondary set, microbore tubing, 2-piece male luer lock, syringe holder and hanger</p> <p>Approximate set length: 28" 71 cm. approx.</p> <p>Approximate priming volume: 1.3 mL</p>	 50

11.00 Secondary administration sets

11.03 Secondary administration sets







Secondary sets provide access to primary infusion sets via MaxPlus needleless connectors and y-sites, SmartSite needle-free valves and VersaSafe split septum ports.

Model #	Drops	Description	Case quantity
4900-0000	20	 <p>Vented/non-vented secondary set, spin male luer lock and hanger</p> <p>Approximate set length: 41" 104 cm. approx.</p> <p>Approximate priming volume: 10 mL</p>	 50
A 492	20	 <p>Vented/non-vented secondary set, spin male luer lock and 2 hangers.</p> <p>Approximate set length: 41" 104 cm. approx.</p> <p>Approximate priming volume: 10 mL</p>	 50
9385-0500	20	 <p>Vented/non-vented secondary set, 18 gauge shielded needle and hanger</p> <p>Approximate set length: 45" 114 cm. approx.</p> <p>Approximate priming volume: 14 mL</p>	30
9387-0500	20	 <p>Vented/non-vented secondary set, 11 gauge blunt plastic cannula and hanger</p> <p>Approximate set length: 44" 111 cm. approx.</p> <p>Approximate priming volume: 14 mL</p>	30
9987-0000	20	 <p>Vented/non-vented secondary set, spin male luer lock and hanger</p> <p>Approximate set length: 43" 108 cm. approx.</p> <p>Approximate priming volume: 14 mL</p>	30

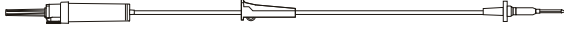
11.00 Secondary administration sets

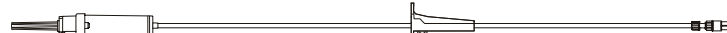
11.03 Secondary administration sets







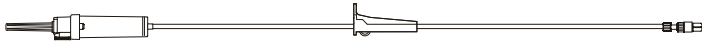

Secondary sets provide access to primary infusion sets via MaxPlus needleless connectors and y-sites, SmartSite needle-free valves and VersaSafe split septum ports.

Model #	Drops	Description	Case quantity
70027	20	 <p>Vented/non-vented secondary set, 18 gauge protected needle and hanger</p> <p>Approximate set length: 37" 94 cm. approx.</p> <p>Approximate priming volume: 12 mL</p>	100
72213	20	 <p>Vented/non-vented secondary set, 18 gauge needle and hanger</p> <p>Approximate set length: 33" 84 cm. approx.</p> <p>Approximate priming volume: 11 mL</p>	100
72213N	20	 <p>Vented/non-vented secondary set, spin male luer lock and hanger</p> <p>Approximate set length: 31" 79 cm. approx.</p> <p>Approximate priming volume: 11 mL</p>	100
72215N	15	 <p>Vented/non-vented secondary set, spin male luer lock and hanger</p> <p>Approximate set length: 40" 102 cm. approx.</p> <p>Approximate priming volume: 13 mL</p>	 100
10016073	20	 <p>Vented/non-vented secondary set, spin male luer lock and hanger</p> <p>Approximate set length: 31" 79 cm. approx.</p> <p>Approximate priming volume: 11 mL</p>	 100

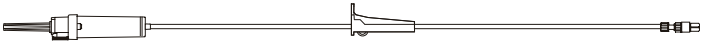
11.00 Secondary administration sets

11.03 Secondary administration sets





Secondary sets provide access to primary infusion sets via MaxPlus needleless connectors and y-sites, SmartSite needle-free valves and VersaSafe split septum ports.

Model #	Drops	Description	Case quantity
11448964	20	 <p>Vented/non-vented secondary set, spin male luer lock and hanger Approximate set length: 36" 91 cm. approx. Approximate priming volume: 12 mL</p>	 100
11582774	20	 <p>Vented/non-vented secondary set, spin male luer lock and hanger Approximate set length: 36" 91 cm. approx. Approximate priming volume: 12 mL</p>	 100
MS3500	20	 <p>Secondary set, roller clamp, male spin lock, bag hanger Approximate set length: 36" 92 cm. approx.</p>	 100
MS3500-15	15	 <p>Secondary set, roller clamp, male spin lock, bag hanger Approximate set length: 36" 92 cm. approx.</p>	 100

12.00 Gravity sets

12.01.01 Stopcocks and manifolds | MaxPlus needleless connectors and y-site sets

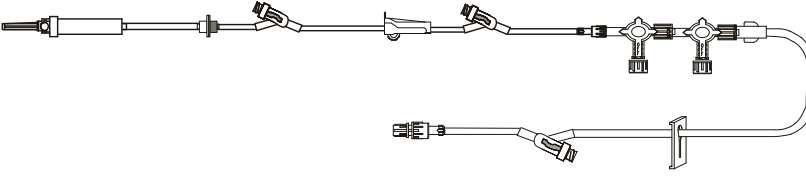
Administration sets for use as gravity sets. All sets are latex free. Some sets include MaxPlus needleless connectors and y-sites, SmartSite needle-free valves or VersaSafe split septum ports.









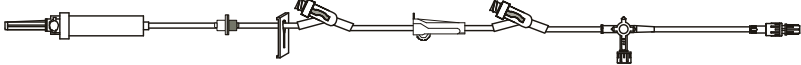

Model #	Drops	Description	Case quantity
MX4449	15	 <p>Administration set, needleless y-site, three 4-way stopcocks ("OFF" Indicator), back check valve, roller clamp, male spin lock</p> <p>Approximate set length: 119" 302 cm. approx.</p>	 25
MX4452	15	 <p>Administration set, 3 needleless y-sites, two 4-way stopcocks ("OFF" Indicator), back check valve, roller clamp, slide clamp, male spin lock</p> <p>Approximate set length: 137" 348 cm. approx.</p>	 25

30-day lead time

12.00 Gravity sets

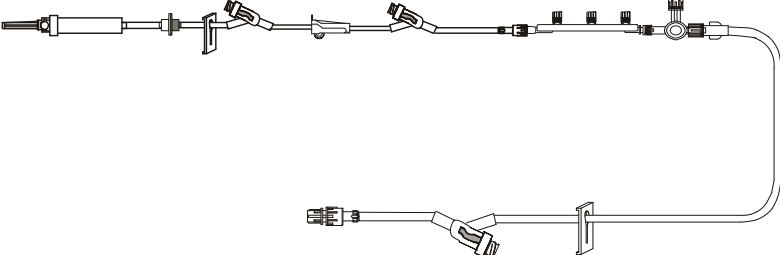
12.01.01 Stopcocks and manifolds | MaxPlus needleless connectors and y-site sets

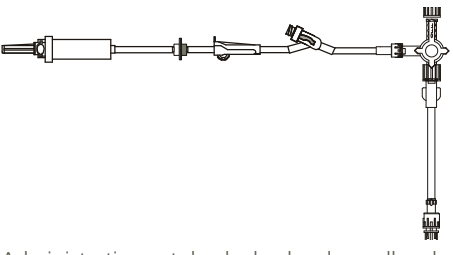



Administration sets for use as gravity sets. All sets are latex free. Some sets include MaxPlus needleless connectors and y-sites, SmartSite needle-free valves or VersaSafe split septum ports.

Model #	Drops	Description	Case quantity
MX4410 		Administration set, 2 needleless y-sites, 4-way stopcock ("OFF" Indicator), back check valve, slide clamp, roller clamp, male spin lock Approximate set length: 145" 368.3 cm. approx.	 25
MX4412 30-day lead time 		Administration set, back check valve, 2 needleless y-sites, roller clamp, 3-port manifold, male spin lock Approximate set length: 90" 229 cm. approx.	 25
MX4436 30-day lead time 		Administration set, 3 needleless y-sites, removable 3-port manifold, removable 4-way stopcock ("OFF" Indicator), back check valve, roller clamp, slide clamp, male spin lock Approximate set length: 155" 393 cm. approx.	 25
MX4441 		Administration set, back check valve, roller clamp, needleless y-site, 4-way stopcock ("OFF" Indicator), male spin lock Approximate set length: 119" 302 cm. approx.	 50

12.00 Gravity sets

12.01.02 Stopcocks and manifolds | SmartSite valve sets





Administration sets for use as gravity sets. All sets are latex free. Some sets include MaxPlus needless connectors and y-sites, SmartSite needle-free valves or VersaSafe split septum ports.

Model #	Drops	Description	Case quantity
42502E	10	 <p>Gravity set, check valve, 4-way stopcock, two 1-way valves, 2 needle-free valves 107" and 9" from spin male luer lock</p> <p>Approximate set length: 124" 315 cm. approx.</p> <p>Approximate priming volume: 26 mL</p>	50
42503E	10	 <p>Gravity set, check valve, 4-way stopcock, 3 needle-free valves 79", 46" and 6" from spin male luer lock</p> <p>Approximate set length: 104" 264 cm. approx.</p> <p>Approximate priming volume: 22 mL</p>	100
42504E	10	 <p>Gravity set, check valve, 3-ganged 4-way stopcock, 2 needle-free valves 98" and 6" from spin male luer lock</p> <p>Approximate set length: 117" 297 cm. approx.</p> <p>Approximate priming volume: 24 mL</p>	50
42511E	20	 <p>Gravity set, check valve, 4-way stopcock, two 1-way valves, 2 needle-free valves 105" and 6" from spin male luer lock</p> <p>Approximate set length: 121" 307 cm. approx.</p> <p>Approximate priming volume: 23 mL</p>	50
42519E	20	 <p>Gravity set, check valve, manifold with three 1-way valves, 2 needle-free valves 96" and 6" from 2-piece male luer lock</p> <p>Approximate set length: 119" 302 cm. approx.</p> <p>Approximate priming volume: 23 mL</p>	20

12.00 Gravity sets

12.01.02 Stopcocks and manifolds | SmartSite valve sets

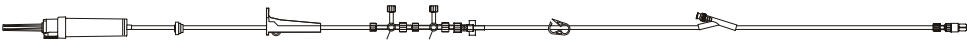
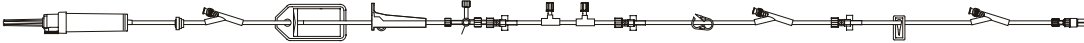

Administration sets for use as gravity sets. All sets are latex free. Some sets include MaxPlus needleless connectors and y-sites, SmartSite needle-free valves or VersaSafe split septum ports.

Model #	Drops	Description	Case quantity
42521E	15	 <p>Gravity set, check valve, 2-ganged 4-way stopcock ("OFF" Indicator), 3 needle-free valves 111", 36" and 6" from 2-piece male luer lock</p> <p>Approximate set length: 136" 346 cm. approx.</p> <p>Approximate priming volume: 28 mL</p>	 20
10011265	10	 <p>Gravity set, check valve, 2-ganged 3-way stopcock, 1 needle-free valve 6" from 2-piece male luer lock</p> <p>Approximate set length: 126" 320 cm. approx.</p> <p>Approximate priming volume: 24 mL</p>	50
10011611	20	 <p>Gravity set, check valve, 0.2 micron (low-protein binding) filter, 4-way stopcock, two 1-way valves, 3 needle-free valves 106", 14" and 5" from spin male luer lock</p> <p>Approximate set length: 123" 312 cm. approx.</p> <p>Approximate priming volume: 27 mL</p>	20
10050186	60	 <p>Gravity set, 2-ganged 4-way stopcock, 1 needle-free valve 8" from 2-piece male luer lock</p> <p>Approximate set length: 65" 165 cm. approx.</p> <p>Approximate priming volume: 15 mL</p>	50

12.00 Gravity sets

12.01.02 Stopcocks and manifolds | SmartSite valve sets

Administration sets for use as gravity sets. All sets are latex free. Some sets include MaxPlus needleless connectors and y-sites, SmartSite needle-free valves or VersaSafe split septum ports.

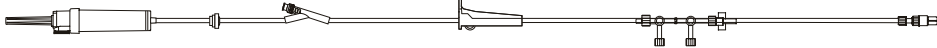
Model #	Drops	Description	Case quantity
10050187 30-day lead time	60	 Gravity set, 4-ganged 4-way stopcock, 2 needle-free valves 57" and 32" from 2-piece male luer lock Approximate set length: 74" 188 cm. approx. Approximate priming volume: 17 mL	20
10425228 30-day lead time	60	 Gravity set, check valve, 4-way stopcock ("OFF" Indicator), 4 needle-free valves 79", 45", 28" and 4" from 2-piece male luer lock Approximate set length: 99" 251 cm. approx. Approximate priming volume: 20 mL	20
10425229 30-day lead time	20	 Gravity set, check valve, 4-way stopcock ("OFF" Indicator), 4 needle-free valves 79", 45", 28" and 4" from 2-piece male luer lock Approximate set length: 98" 249 cm. approx. Approximate priming volume: 20 mL	20
10879046 30-day lead time	15	 Gravity set, check valve, 2-ganged 3-way stopcock, 1 needle-free valve 107" from 2-piece male luer lock Approximate set length: 135" 343 cm. approx. Approximate priming volume: 27 mL	50



12.00 Gravity sets

12.01.02 Stopcocks and manifolds | SmartSite valve sets

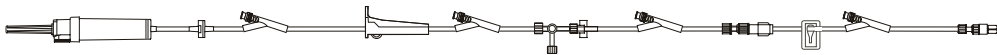
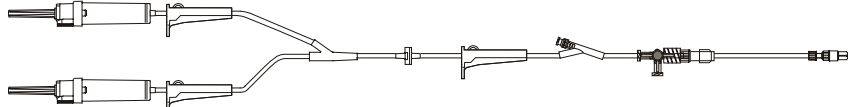
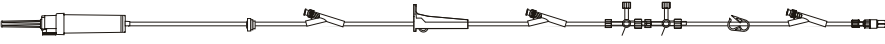

Administration sets for use as gravity sets. All sets are latex free. Some sets include MaxPlus needleless connectors and y-sites, SmartSite needle-free valves or VersaSafe split septum ports.

Model #	Drops	Description	Case quantity
11059727 30-day lead time	60	 Gravity set, check valve, 4-way stopcock ("OFF" Indicator), 4 needle-free valves 84", 50", 31" and 6" from 2-piece male luer lock Approximate set length: 101" 257 cm. approx. Approximate priming volume: 21 mL	20
11059728 30-day lead time	20	 Gravity set, check valve, 4-way stopcock ("OFF" Indicator), 4 needle-free valves 84", 50", 31" and 6" from 2-piece male luer lock Approximate set length: 102" 259 cm. approx. Approximate priming volume: 21 mL	20
11627697 30-day lead time	10	 Gravity set, 2 drip chambers, check valve, 4-way stopcock ("OFF" Indicator), 1 needle-free valve 49" from 2-piece male luer lock Approximate set length: 131" 333 cm. approx. Approximate priming volume: 36 mL	20
C42006E	10	 Gravity set, check valve, 2-ganged 4-way stopcock ("OFF" Indicator), 3 needle-free valves 113", 35" and 6" from 2-piece male luer lock Approximate set length: 139" 352 cm. approx. Approximate priming volume: 26 mL	20

12.00 Gravity sets

12.01.02 Stopcocks and manifolds | SmartSite valve sets

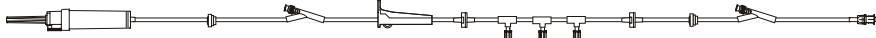

Administration sets for use as gravity sets. All sets are latex free. Some sets include MaxPlus needleless connectors and y-sites, SmartSite needle-free valves or VersaSafe split septum ports.

Model #	Drops	Description	Case quantity
C42010E	10	 <p>Gravity set, check valve, 4-way stopcock ("OFF" Indicator), 3 needle-free valves 118", 40" and 6" from 2-piece fixed male luer lock</p> <p>Approximate set length: 141" 358 cm. approx.</p> <p>Approximate priming volume: 25 mL</p>	20
C42012E	10	 <p>Gravity set, 2 check valves, three 1-way valves, 2 needle-free valves 88" and 7" from spin male luer lock</p> <p>Approximate set length: 104" 264 cm. approx.</p> <p>Approximate priming volume: 23 mL</p>	50
C42013E	20	 <p>Gravity set, check valve, two 1-way valves, 2 split septum ports 114" and 59" from spin male luer lock, 1 needle-free valve 6" from spin male luer lock</p> <p>Approximate set length: 131" 333 cm. approx.</p> <p>Approximate priming volume: 26 mL</p>	50

12.00 Gravity sets

12.01.03 Stopcocks and manifolds | VersaSafe split septum sets





Administration sets for use as gravity sets. All sets are latex free. Some sets include MaxPlus needleless connectors and y-sites, SmartSite needle-free valves or VersaSafe split septum ports.

Model #	Drops	Description	Case quantity
11147994	10	 <p>Gravity set, check valve, 3-way stopcock, 2 split septum ports 113" and 44" from 2-piece male luer lock</p> <p>Approximate set length: 134" 340 cm. approx.</p> <p>Approximate priming volume: 27 mL</p>	20
C42013E	20	 <p>Gravity set, check valve, two 1-way valves, 2 split septum ports 114" and 59" from spin male luer lock, 1 needle-free valve 6" from spin male luer lock</p> <p>Approximate set length: 131" 333 cm. approx.</p> <p>Approximate priming volume: 26 mL</p>	50

12.00 Gravity sets

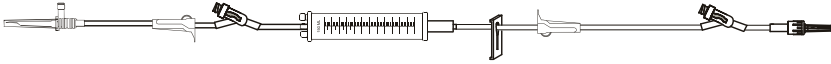
12.02.01 Burettes | MaxPlus needleless connectors and y-site sets

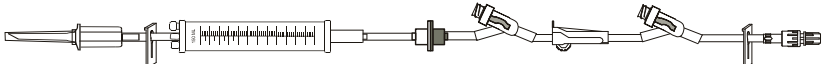





Administration sets for use as gravity sets. All sets are latex free. Some sets include MaxPlus needleless connectors and y-sites, SmartSite needle-free valves or VersaSafe split septum ports.

Model #	Drops	Description	Case quantity
MX4416 30-day lead time		 <p>Administration set, 150 mL burette, 2 needleless y-sites, 2 roller clamps, slide clamp, male luer lock</p> <p>Approximate set length: 84" 213.3 cm. approx.</p>	 25
MX9407 30-day lead time		 <p>Administration set, 150 mL burette, 2 needleless y-sites, back check valve, roller clamp, slide clamp, male spin lock</p> <p>Approximate set length: 90" 234 cm. approx.</p>	 25

12.00 Gravity sets

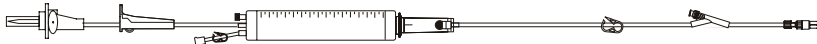
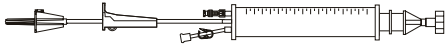
12.02.02 Burettes | SmartSite valve sets

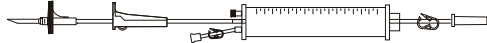

Administration sets for use as gravity sets. All sets are latex free. Some sets include MaxPlus needleless connectors and y-sites, SmartSite needle-free valves or VersaSafe split septum ports.

Model #	Drops	Description	Case quantity
42163E 30-day lead time	60	 Gravity set, 150 mL burette (needle-free valve), 1 needle-free valve 10" from 2-piece male luer lock Approximate set length: 116" 295 cm. approx. Approximate priming volume: 22 mL	10
82005E 30-day lead time	20	 150 mL add-on burette set (needle-free valve), ball valve in drip chamber, pigtail spike adapter connector. Approximate set length: 26" 66 cm. approx.	20
82104E 30-day lead time	60	 Gravity set, 150 mL burette (needle-free valve), ball valve in drip chamber, 1 needle-free valve 10" from 2-piece male luer lock Approximate set length: 100" 254 cm. approx. Approximate priming volume: 18 mL	20
82113E		 150 mL add-on burette (needle-free valve), spike adapter. Approximate set length: 21" 53 cm. approx.	 20
82114E		 150 mL add-on burette (needle-free valve), pigtail spike adapter. Approximate set length: 24" 61 cm. approx.	 20

12.00 Gravity sets

12.02.02 Burettes | SmartSite valve sets

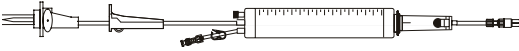

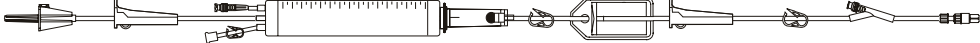
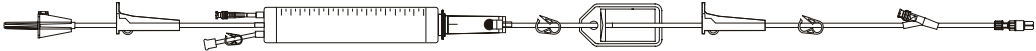



Administration sets for use as gravity sets. All sets are latex free. Some sets include MaxPlus needleless connectors and y-sites, SmartSite needle-free valves or VersaSafe split septum ports.

Model #	Drops	Description	Case quantity
82115E	20	 <p>150 mL add-on burette (needle-free valve), ball valve in drip chamber, pigtail spike adapter. Approximate set length: 25" 64 cm. approx.</p>	20
10011087	60	 <p>Gravity set, 150 mL burette (needle-free valve), ball valve in drip chamber, smallbore tubing segment, 2 needle-free valves 47" and 4" from male luer lock, 4 split septum ports 67", 49", 32" and 6" from spin male luer lock Approximate set length: 127" 323 cm. approx. Approximate priming volume: 18 mL</p>	10
10012564	60	 <p>Gravity set, 150 mL burette (needle-free valve), ball valve in drip chamber, 2 needle-free valves 43" and 6" from 2-piece male luer lock Approximate set length: 105" 265 cm. approx. Approximate priming volume: 18 mL</p>	10
10037031	60	 <p>Gravity set, 150 mL burette (needle-free valve), ball valve in drip chamber, 1.2 micron (low-protein binding) filter, 1 needle free valve 10" from 2 piece male luer lock Approximate set length: 100" 254 cm. approx. Approximate priming volume: 21 mL</p>	20
10037032	20	 <p>Gravity set, 150 mL burette (needle-free valve), ball valve in drip chamber, 1.2 micron (low-protein binding) filter, 1 needle free valve 10" from 2 piece male luer lock Approximate set length: 100" 254 cm. approx. Approximate priming volume: 21 mL</p>	20

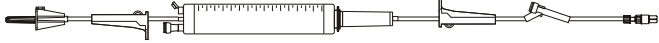
12.00 Gravity sets

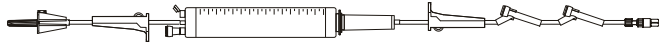
12.02.03 Burettes | VersaSafe split septum sets

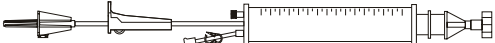

Administration sets for use as gravity sets. All sets are latex free. Some sets include MaxPlus needleless connectors and y-sites, SmartSite needle-free valves or VersaSafe split septum ports.

Model #	Drops	Description	Case quantity
10807857 30-day lead time		 <p>Gravity set, 150 mL burette (split septum port), 1 split septum port 6" from 2-piece male luer lock</p> <p>Approximate set length: 116" 295 cm. approx.</p> <p>Approximate priming volume: 25 mL</p>	 10
10849550		 <p>Gravity set, 150 mL burette (split septum port), 2 split septum ports 25" and 10" from 2-piece male luer lock</p> <p>Approximate set length: 100" 254 cm. approx.</p> <p>Approximate priming volume: 21 mL</p>	 10
11607532		 <p>150 mL add-on burette (split septum port), spike adapter.</p> <p>Approximate set length: 21" 53 cm. approx.</p> <p>Approximate priming volume: 35 mL</p>	 20

12.00 Gravity sets

12.03 Low sorbing tubing | SmartSite valve sets

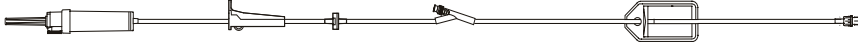

Administration sets for use as gravity sets. All sets are latex free. Some sets include MaxPlus needleless connectors and y-sites, SmartSite needle-free valves or VersaSafe split septum ports.

Model #	Drops	Description	Case quantity
10015104 30-day lead time		 Low sorbing gravity set, check valve, 0.2 micron (low-protein binding) filter, 1 needle-free valve 82" from fixed male luer lock Approximate set length: 106" 270 cm. approx. Approximate priming volume: 25 mL	 50

12.00 Gravity sets

12.04.01.01 Filters | Blood filters | SmartSite valve sets



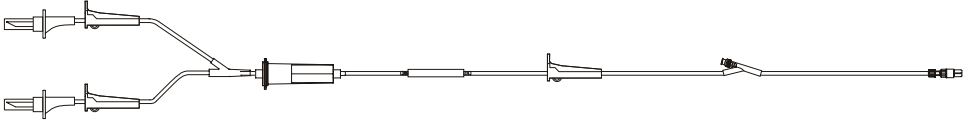



Administration sets for use as gravity sets. All sets are latex free. Some sets include MaxPlus needleless connectors and y-sites, SmartSite needle-free valves or VersaSafe split septum ports.

Model #	Drops	Description	Case quantity
42081E	15	 <p>Non-vented gravity blood set, 180 micron blood filter, 1 needle-free valve 9" from 2-piece male luer lock</p> <p>Approximate set length: 104" 264 cm. approx.</p> <p>Approximate priming volume: 30 mL</p>	 20
42082E	20	 <p>Non-vented gravity blood set, blunt short spike, 200 micron filter, 2 needle-free valves 50" and 10" from 2-piece male luer lock</p> <p>Approximate set length: 108" 274 cm. approx.</p> <p>Approximate priming volume: 29 mL</p>	20
10010903	15	 <p>Non-vented gravity blood set with pressure pump, 180 micron filter, 1 needle-free valve 9" from 2-piece male luer lock</p> <p>Approximate set length: 105" 267 cm. approx.</p> <p>Approximate priming volume: 67 mL</p>	20

12.00 Gravity sets

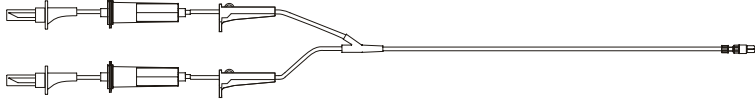
12.04.01.02 Filters | Blood filters | No port sets

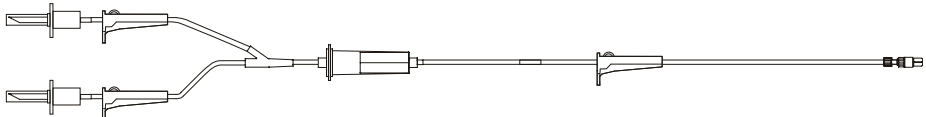

Administration sets for use as gravity sets. All sets are latex free. Some sets include MaxPlus needleless connectors and y-sites, SmartSite needle-free valves or VersaSafe split septum ports.

Model #	Drops	Description	Case quantity
42085	20	 <p>Non-vented add-on blood set, single spike, 200 micron filter, spike adapter.</p> <p>Approximate set length: 11" 28 cm. approx.</p> <p>Approximate priming volume: 14 mL</p>	100
30-day lead time			
10015492	15	 <p>Non-vented gravity blood set, 180 micron filter, 2-piece male luer lock</p> <p>Approximate set length: 103" 263 cm. approx.</p> <p>Approximate priming volume: 29 mL</p>	10
10137407	20	 <p>Non-vented gravity blood set, two 200 micron filters, 2-piece male luer lock</p> <p>Approximate set length: 34" 86 cm. approx.</p> <p>Approximate priming volume: 32 mL</p>	 20
30-day lead time			
10387509	20	 <p>Non-vented gravity blood set, single spike, 200 micron filter, 2-piece male luer lock</p> <p>Approximate set length: 105" 267 cm. approx.</p> <p>Approximate priming volume: 27 mL</p>	50
10844551	20	 <p>Non-vented gravity blood set, single spike, 200 micron filter, 2-piece male luer lock</p> <p>Approximate set length: 55" 140 cm. approx.</p> <p>Approximate priming volume: 19 mL</p>	20
10869591	15	 <p>Non-vented gravity blood set, 180 micron filter, 2-piece male luer lock</p> <p>Approximate set length: 103" 262 cm. approx.</p> <p>Approximate priming volume: 29 mL</p>	10
30-day lead time			

12.00 Gravity sets

12.04.02.01 Filters | 0.2 micron filters | SmartSite valve sets

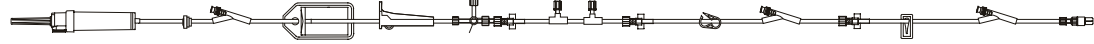

Administration sets for use as gravity sets. All sets are latex free. Some sets include MaxPlus needleless connectors and y-sites, SmartSite needle-free valves or VersaSafe split septum ports.

Model #	Drops	Description	Case quantity
42933E	20	 <p>Gravity set, check valve, 0.2 micron (low-protein binding) filter, 2 needle-free valves 42" and 10" from 2-piece male luer lock</p> <p>Approximate set length: 105" 267 cm. approx.</p> <p>Approximate priming volume: 24 mL</p>	50
10011611	20	 <p>Gravity set, check valve, 0.2 micron (low-protein binding) filter, 4-way stopcock, two 1-way valves, 3 needle-free valves 106", 14" and 5" from spin male luer lock</p> <p>Approximate set length: 123" 312 cm. approx.</p> <p>Approximate priming volume: 27 mL</p>	20
10015104	10	 <p>Low sorbing gravity set, check valve, 0.2 micron (low-protein binding) filter, 1 needle-free valve 82" from fixed male luer lock</p> <p>Approximate set length: 106" 270 cm. approx.</p> <p>Approximate priming volume: 25 mL</p>	 50

12.00 Gravity sets

12.04.02.02 Filters | 0.2 micron filters | MaxPlus needleless connector and y-site sets

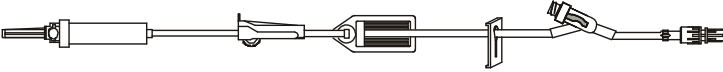









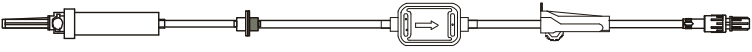

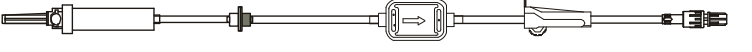
Administration sets for use as gravity sets. All sets are latex free. Some sets include MaxPlus needleless connectors and y-sites, SmartSite needle-free valves or VersaSafe split septum ports.

Model #	Drops	Description	Case quantity
MS3542 30-day lead time	15	 Administration set, needleless y-site, 0.2 micron filter, roller clamp, slide clamp, male spin lock Approximate set length: 100" 254 cm. approx.	 50

12.00 Gravity sets

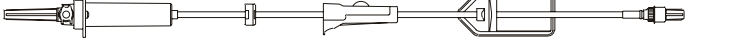
12.04.02.03 Filters | 0.2 micron filters | No port sets

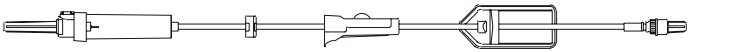
Administration sets for use as gravity sets. All sets are latex free. Some sets include MaxPlus needleless connectors and y-sites, SmartSite needle-free valves or VersaSafe split septum ports.

Model #	Drops	Description	Case quantity
MA3137 30-day lead time	20	 Administration set, 0.2 micron filter, check valve, roller clamp, male spin lock Approximate set length: 47" 119 cm. approx.	 50
MA3138 30-day lead time	60	 Administration set, 0.2 micron filter, check valve, roller clamp, male spin lock Approximate set length: 47" 119 cm. approx.	 50
MB3110 30-day lead time	10	 Administration set, 0.2 micron filter, roller clamp, male spin lock Approximate set length: 95" 241.3 cm. approx.	 50
MFS120 30-day lead time	15	 Administration set, flow regulator, 0.2 micron filter, slide clamp, male spin lock Approximate set length: 84" 213 cm. approx.	 50
42002-07 30-day lead time	20	 Vented/non vented gravity set, 0.2 micron filter, check valve, spin male luer lock Approximate set length: 47" 119 cm. approx. Approximate priming volume: 16 mL	 100
42006-07 30-day lead time	60	 Vented/non vented gravity set, 0.2 micron filter, check valve, spin male luer lock Approximate set length: 47" 119 cm. approx. Approximate priming volume: 16 mL	 100

12.00 Gravity sets

12.04.03 Filters | 1.2 micron filters

Administration sets for use as gravity sets. All sets are latex free. Some sets include MaxPlus needleless connectors and y-sites, SmartSite needle-free valves or VersaSafe split septum ports.

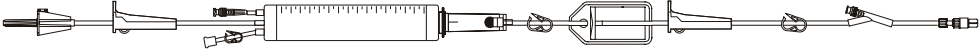
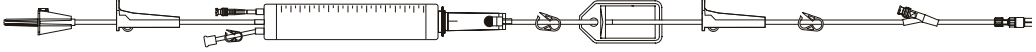

Model #	Drops	Description	Case quantity
10037031	60	 <p>Gravity set, 150 mL burette (needle-free valve), ball valve in drip chamber, 1.2 micron (low-protein binding) filter, 1 needle-free valve 10" from 2-piece male luer lock</p> <p>Approximate set length: 100" 254 cm. approx.</p> <p>Approximate priming volume: 21 mL</p>	20
10037032	20	 <p>Gravity set, 150 mL burette (needle-free valve), ball valve in drip chamber, 1.2 micron (low-protein binding) filter, 1 needle-free valve 10" from 2-piece male luer lock</p> <p>Approximate set length: 100" 254 cm. approx.</p> <p>Approximate priming volume: 21 mL</p>	20

30-day lead time

12.00 Gravity sets

12.04.04 Filters | 15 micron filters



Administration sets for use as gravity sets. All sets are latex free. Some sets include MaxPlus needleless connectors and y-sites, SmartSite needle-free valves or VersaSafe split septum ports.

Model #	Drops	Description	Case quantity
C42001		 Gravity set, 15 micron filter (drip chamber), 2-piece male luer lock	100
30-day lead time		Approximate set length: 92" 233 cm. approx. Approximate priming volume: 19 mL	

12.00 Gravity sets

12.05.01 Special applications | Ball valve sets

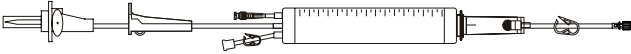
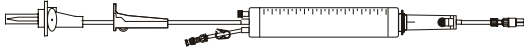
Administration sets for use as gravity sets. All sets are latex free. Some sets include MaxPlus needleless connectors and y-sites, SmartSite needle-free valves or VersaSafe split septum ports.

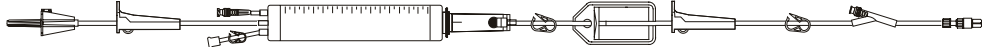
Model #	Drops	Description	Case quantity
82005E 30-day lead time	20	 <p>150 mL add-on burette set (needle-free valve), ball valve in drip chamber, pigtail spike adapter connector.</p> <p>Approximate set length: 26" 66 cm. approx.</p>	20
82115E	20	 <p>150 mL add-on burette (needle-free valve), ball valve in drip chamber, pigtail spike adapter.</p> <p>Approximate set length: 25" 64 cm. approx.</p>	20
10011087	60	 <p>Gravity set, 150 mL burette (needle-free valve), ball valve in drip chamber, smallbore tubing segment, 2 needle-free valves 47" and 4" from spin male luer lock, 4 split septum ports 67", 49" 32" and 6" from spin male luer lock</p> <p>Approximate set length: 127" 323 cm. approx.</p> <p>Approximate priming volume: 18 mL</p>	10
10012564 30-day lead time	60	 <p>Gravity set, 150 mL burette (needle-free valve), ball valve in drip chamber, 2 needle-free valves 43" and 6" from 2-piece male luer lock</p> <p>Approximate set length: 105" 265 cm. approx.</p> <p>Approximate priming volume: 18 mL</p>	10
10037031	60	 <p>Gravity set, 150 mL burette (needle-free valve), ball valve in drip chamber, 1.2 micron (low-protein binding) filter, 1 needle-free valve 10" from 2-piece male luer lock</p> <p>Approximate set length: 100" 254 cm. approx.</p> <p>Approximate priming volume: 21 mL</p>	20

12.00 Gravity sets

12.05.01 Special applications | Ball valve sets

Administration sets for use as gravity sets. All sets are latex free. Some sets include MaxPlus needleless connectors and y-sites, SmartSite needle-free valves or VersaSafe split septum ports.

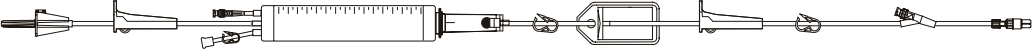







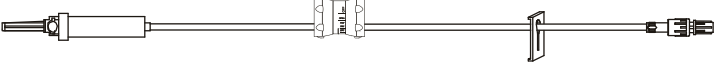

Model #	Drops	Description	Case quantity
10037032	 20	 Gravity set, 150 mL burette (needle-free valve), ball valve in drip chamber, 1.2 micron (low-protein binding) filter, 1 needle-free valve 10" from 2-piece male luer lock Approximate set length: 100" 254 cm. approx. Approximate priming volume: 21 mL	20

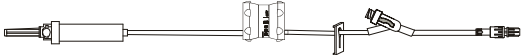
30-day lead time

12.00 Gravity sets

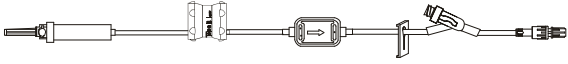
12.05.02 Special applications | Flow regulator sets









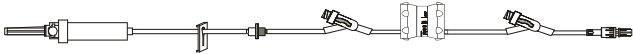

Administration sets for use as gravity sets. All sets are latex free. Some sets include MaxPlus needleless connectors and y-sites, SmartSite needle-free valves, injection sites or VersaSafe split septum ports.

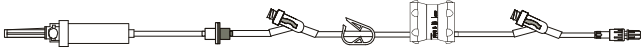
Model #	Drops	Description	Case quantity
MFS100	10	 <p>Administration set, flow regulator, slide clamp, male spin clamp Approximate set length: 100" 254 cm. approx.</p>	 50
MFS102	10	 <p>Administration set, flow regulator, slide clamp, needleless y-site, male spin lock Approximate set length: 100" 254 cm. approx.</p>	 50
MFS120	15	 <p>Administration set, flow regulator, 0.2 micron filter, slide clamp, male spin lock Approximate set length: 84" 213 cm. approx.</p>	 50
MFS121	15	 <p>Administration set, flow regulator, 0.2 micron filter, slide clamp, needleless y-site, male spin lock Approximate set length: 90" 228.6 cm. approx.</p>	 50
MFS124	15	 <p>Administration set, flow regulator, 2 needleless y-sites, slide clamp, back check valve, male spin lock Approximate set length: 75" 191 cm. approx.</p>	 50

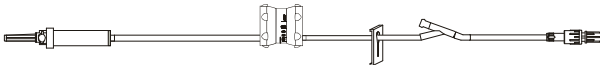
12.00 Gravity sets

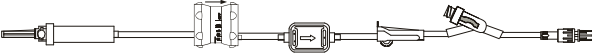
12.05.02 Special applications | Flow regulator sets

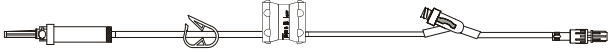





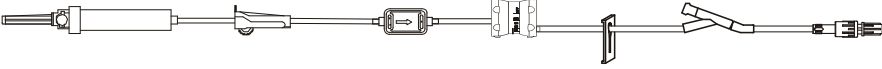

Administration sets for use as gravity sets. All sets are latex free. Some sets include MaxPlus needleless connectors and y-sites, SmartSite needle-free valves, injection sites or VersaSafe split septum ports.

Model #	Drops	Description	Case quantity
MFS125	20	 <p>Administration set, flow regulator, slide clamp, injection site, male spin lock Approximate set length: 100" 254 cm. approx.</p>	 50
MFS132	20	 <p>Administration set, flow controller, 2 needleless y-sites, back check valve, pinch clamp, male spin lock Approximate set length: 83" 211 cm. approx.</p>	 50
MFS133	20	 <p>Administration set, flow regulator, slide clamp, injection site, male spin lock Approximate set length: 100" 254 cm. approx.</p>	 50
MFS134	15	 <p>Administration set, flow controller, 0.2 micron filter, needleless y-site, roller clamp, male spin lock Approximate set length: 90" 229 cm. approx.</p>	 25
MFS135	20	 <p>Administration set, pinch clamp, flow regulator, 15 micron filter, needleless y-site Approximate set length: 86" 218 cm. approx.</p>	 50

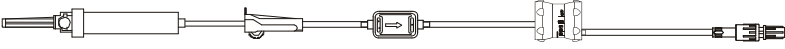
12.00 Gravity sets

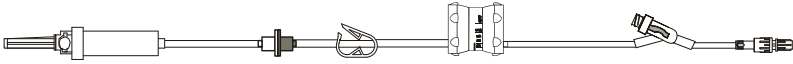
12.05.02 Special applications | Flow regulator sets

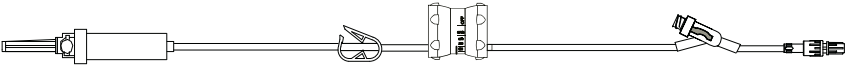









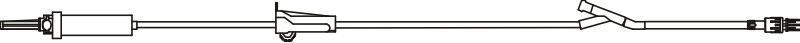

Administration sets for use as gravity sets. All sets are latex free. Some sets include MaxPlus needleless connectors and y-sites, SmartSite needle-free valves, injection sites or VersaSafe split septum ports.

Model #	Drops	Description	Case quantity
MFS136	20	 <p>Administration set, flow regulator, 0.2 micron filter, injection site</p> <p>Approximate set length: 64" 162.4 cm. approx.</p>	 50
MFS137	10	 <p>Administration set, flow regulator, 0.2 micron filter</p> <p>Approximate set length: 74" 188 cm. approx.</p>	 50
MFS139	20	 <p>Gravity set, check valve, flow regulator, 1 needleless y-site 5" from 2-piece male luer lock</p> <p>Approximate set length: 84" 216 cm. approx.</p> <p>Approximate priming volume: 13 mL</p>	 50
MFS140	20	 <p>Gravity set, flow regulator, 1 needleless y-site 5" from 2-piece male luer lock</p> <p>Approximate set length: 84" 216 cm. approx.</p> <p>Approximate priming volume: 13 mL</p>	 50

12.00 Gravity sets

12.06.01 Primary administration sets | MaxPlus needleless connectors and y-site sets

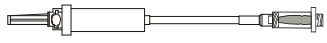
Administration sets for use as gravity sets. All sets are latex free. Some sets include MaxPlus needleless connectors and y-sites, SmartSite needle-free valves or VersaSafe split septum ports.

Model #	Drops	Description	Case quantity
MA3090 30-day lead time	10	 Administration set, injection site, male spin lock Approximate set length: 83" 83 cm. approx.	 50
MB3105	10	 Administration set, 2 needleless y-sites, roller clamp, male spin lock Approximate set length: 96" 243.8 cm. approx.	 50
MB3107	10	 Administration set, needleless y-site, roller clamp, male spin lock Approximate set length: 95" 241.3 cm. approx.	 50
MC3102	15	 Administration set, needleless y-site, roller clamp, male spin lock Approximate set length: 84" 213 cm. approx.	 50
MS3101	15	 Administration set, 2 needleless y-sites, back check valve, slide clamp, roller clamp, male spin lock Approximate set length: 110" 279.4 cm. approx.	 50
MT6004 30-day lead time	15	 Administration set, standard needleless connector Approximate set length: 8.5" 21.59 cm. approx.	 50

12.00 Gravity sets

12.06.01 Primary administration sets | MaxPlus needleless connectors and y-site sets











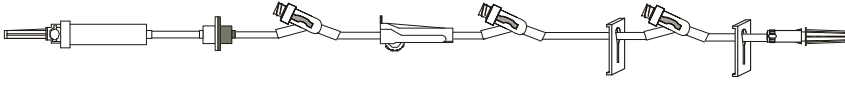

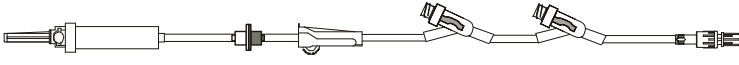
Administration sets for use as gravity sets. All sets are latex free. Some sets include MaxPlus needleless connectors and y-sites, SmartSite needle-free valves or VersaSafe split septum ports.

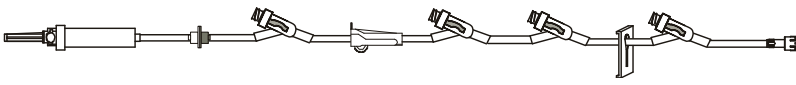
Model #	Drops	Description	Case quantity
MX4443	15	 <p>Administration set, 4 needleless y-sites, back check valve, roller clamp, slide clamp, male spin lock</p> <p>Approximate set length: 170" 432 cm. approx.</p>	 25
MX9107	10	 <p>Administration set, needleless y-site, roller clamp, male spin lock</p> <p>Approximate set length: 90" 229 cm. approx.</p>	 50
MX9128	15	 <p>Administration set, 3 needleless y-sites, back check valve, roller clamp, slide clamp, male spin lock</p> <p>Approximate set length: 112" 284.5 cm. approx.</p>	 50
MX9412	10	 <p>Administration set, 3 needleless y-sites, back check valve, slide clamp, roller clamp, male spin lock</p> <p>Approximate set length: 110" 279.4 cm. approx.</p>	 50
MX9414	60	 <p>Administration set, 3 needleless y-sites, back check valve, roller clamp, slide clamp, male spin lock</p> <p>Approximate set length: 112" 284.4 cm. approx.</p>	 50
MX9416	15	 <p>Administration set, 2 needleless y-sites, back check valve, roller clamp, male spin lock</p> <p>Approximate set length: 110" 279 cm. approx.</p>	 50

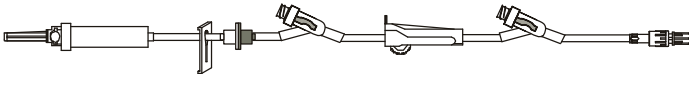
12.00 Gravity sets

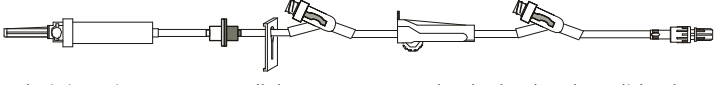
12.06.01 Primary administration sets | MaxPlus needleless connectors and y-site sets







Administration sets for use as gravity sets. All sets are latex free. Some sets include MaxPlus needleless connectors and y-sites, SmartSite needle-free valves or VersaSafe split septum ports.

Model #	Drops	Description	Case quantity
MX9417 30-day lead time	15	 Administration set, 3 needleless y-sites, back check valve, roller clamp, 2 slide clamps, male luer slip Approximate set length: 112" 284.5 cm. approx.	 50
MX9424 30-day lead time	15	 Administration set, 2 needleless y-sites, back check valve, roller clamp, male spin lock Approximate set length: 98" 248.9 cm. approx.	 50
MX9433	15	 Administration set, 4 needleless y-sites, back check valve, roller clamp, slide clamp, male spin lock Approximate set length: 127" 322 cm. approx.	 50
MX9963	60	 Administration set, 2 needleless y-sites, back check valve, slide clamp, roller clamp, male spin lock Approximate set length: 106" 269.2 cm. approx.	 50
MX9968	15	 Administration set, 2 needleless connectors, back check valve, slide clamp, roller clamp, male spin lock Approximate set length: 110" 279 cm. approx.	 50
MX9998	20	 Administration set, 2 needleless y-sites, back check valve, slide clamp, roller clamp, male spin lock Approximate set length: 82" 208.3 cm. approx.	 50

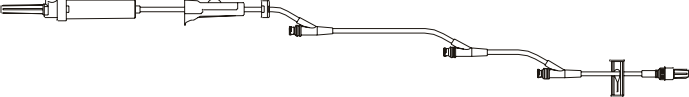
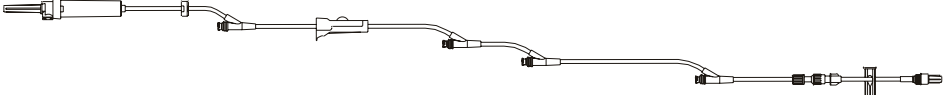
12.00 Gravity sets

12.06.02 Primary administration sets | SmartSite valve sets

Administration sets for use as gravity sets. All sets are latex free. Some sets include MaxPlus needleless connectors and y-sites, SmartSite needle-free valves or VersaSafe split septum ports.

Model #	Drops	Description	Case quantity
41134E	10	 <p>Gravity set, check valve, 3 needle-free valves 83", 23" and 4" from 2-piece male luer lock</p> <p>Approximate set length: 104" 264 cm. approx.</p> <p>Approximate priming volume: 21 mL</p>	100
41135E	10	 <p>Gravity set, 3 needle-free valves 55", 25" and 12" from spin male luer lock</p> <p>Approximate set length: 88" 224 cm. approx.</p> <p>Approximate priming volume: 18 mL</p>	100
41137E	10	 <p>Gravity set, 4 needle-free valves 118", 60", 52" and 15" from 2-piece male luer lock</p> <p>Approximate set length: 136" 345 cm. approx.</p> <p>Approximate priming volume: 27 mL</p>	 50
41173E	20	 <p>Gravity set, 1 needle-free valve 9" from 2-piece male luer lock</p> <p>Approximate set length: 104" 264 cm. approx.</p> <p>Approximate priming volume: 23 mL</p>	 100
41177E	10	 <p>Gravity set, check valve, 2 needle-free valves 83" and 4" from fixed male luer lock</p> <p>Approximate set length: 105" 267 cm. approx.</p> <p>Approximate priming volume: 21 mL</p>	100
42133E	60	 <p>Gravity set, 2 needle-free valves 87" and 10" from 2-piece male luer lock</p> <p>Approximate set length: 104" 264 cm. approx.</p> <p>Approximate priming volume: 21 mL</p>	100

12.00 Gravity sets

12.06.02 Primary administration sets | SmartSite valve sets







Administration sets for use as gravity sets. All sets are latex free. Some sets include MaxPlus needleless connectors and y-sites, SmartSite needle-free valves or VersaSafe split septum ports.

Model #	Drops	Description	Case quantity
42193E-0500	20	 <p>Gravity set, check valve, 1 needle-free valve 10" from 2-piece male luer lock</p> <p>Approximate set length: 104" 264 cm. approx.</p> <p>Approximate priming volume: 20 mL</p>	100
42233E	60	 <p>Gravity set, check valve, 2 needle-free valves 87" and 10" from 2-piece male luer lock</p> <p>Approximate set length: 104" 264 cm. approx.</p> <p>Approximate priming volume: 21 mL</p>	100
42273E	20	 <p>Gravity set, 2 needle-free valves 87" and 10" from 2-piece male luer lock</p> <p>Approximate set length: 104" 264 cm. approx.</p> <p>Approximate priming volume: 21 mL</p>	100
42274E	10	 <p>Gravity set, check valve, 1 needle-free valve 84" from male luer lock, 1 split septum port 6" from 2-piece male luer lock</p> <p>Approximate set length: 104" 264 cm. approx.</p> <p>Approximate priming volume: 21 mL</p>	50
42293E	20	 <p>Gravity set, check valve, 2 needle-free valves 84" and 10" from 2-piece male luer lock</p> <p>Approximate set length: 104" 264 cm. approx.</p> <p>Approximate priming volume: 21 mL</p>	100

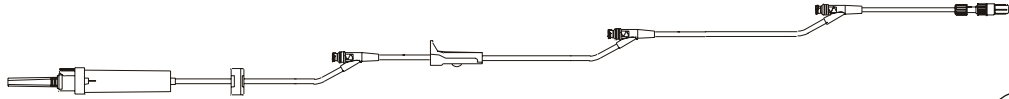
12.00 Gravity sets

12.06.02 Primary administration sets | SmartSite valve sets

Administration sets for use as gravity sets. All sets are latex free. Some sets include MaxPlus needleless connectors and y-sites, SmartSite needle-free valves or VersaSafe split septum ports.

Model #	Drops	Description	Case quantity
42433E	60	 <p>Gravity set, check valve, 3 needle-free valves 88", 42" and 10" from 2-piece male luer lock</p> <p>Approximate set length: 105" 267 cm. approx.</p> <p>Approximate priming volume: 21 mL</p>	100
42434E	60	 <p>Gravity set, check valve, 3 needle-free valves 87", 42" and 9" from 2-piece male luer lock</p> <p>Approximate set length: 104" 264 cm. approx.</p> <p>Approximate priming volume: 23 mL</p>	 100
42493E	20	 <p>Gravity set, check valve, 3 needle-free valves 88", 42" and 10" from 2-piece male luer lock</p> <p>Approximate set length: 105" 267 cm. approx.</p> <p>Approximate priming volume: 21 mL</p>	100
47177E	10	 <p>Gravity set, check valve, 2 needle-free valves 78" and 4" from fixed male luer lock</p> <p>Approximate set length: 104" 264 cm. approx.</p> <p>Approximate priming volume: 23 mL</p>	 100
47233E	60	 <p>Gravity set, check valve, 2 needle-free valves 85" and 9" from 2-piece male luer lock</p> <p>Approximate set length: 104" 264 cm. approx.</p> <p>Approximate priming volume: 22 mL</p>	 100
10010741	10	 <p>Gravity set, 2 needle-free valves 26" and 6" from 2-piece male luer lock</p> <p>Approximate set length: 76" 193 cm. approx.</p> <p>Approximate priming volume: 17 mL</p>	100

30-day lead time

30-day lead time

12.00 Gravity sets

12.06.02 Primary administration sets | SmartSite valve sets





Administration sets for use as gravity sets. All sets are latex free. Some sets include MaxPlus needless connectors and y-sites, SmartSite needle-free valves or VersaSafe split septum ports.

Model #	Drops	Description	Case quantity
10015171 30-day lead time	20	 <p>Gravity set, 2 drip chambers, 1 needle-free valve 6" from 2-piece male luer lock</p> <p>Approximate set length: 105" 265 cm. approx.</p> <p>Approximate priming volume: 31 mL</p>	20
10053857	15	 <p>Gravity set, check valve, 2 needle-free valves 74" and 7" from 2-piece male luer lock</p> <p>Approximate set length: 101" 257 cm. approx.</p> <p>Approximate priming volume: 22 mL</p>	 100
10073124	10	 <p>Gravity set, check valve, 3 needle-free valves 88", 42" and 6" from 2-piece male luer lock</p> <p>Approximate set length: 110" 279 cm. approx.</p> <p>Approximate priming volume: 22 mL</p>	50
10802688	10	 <p>Gravity set, check valve, 3 needle-free valves 41", 36" and 6" from 2-piece male luer lock</p> <p>Approximate set length: 107" 272 cm. approx.</p> <p>Approximate priming volume: 23 mL</p>	 100
11609826 30-day lead time	20	 <p>Gravity set, check valve, 3 needle-free valves 94", 16" and 4" from spin male luer lock</p> <p>Approximate set length: 111" 282 cm. approx.</p> <p>Approximate priming volume: 22 mL</p>	50

12.00 Gravity sets

12.06.02 Primary administration sets | SmartSite valve sets

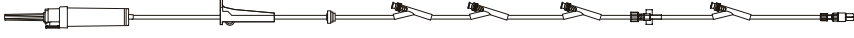





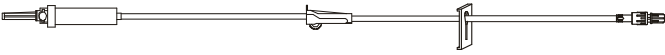

Administration sets for use as gravity sets. All sets are latex free. Some sets include MaxPlus needleless connectors and y-sites, SmartSite needle-free valves or VersaSafe split septum ports.

Model #	Drops	Description	Case quantity
11619427 30-day lead time	10	 Gravity set, check valve, 4 needle-free valves 118", 45", 32" and 7" from spin male luer lock Approximate set length: 140" 356 cm. approx. Approximate priming volume: 25 mL	20
C42002E 30-day lead time	20	 Gravity set, check valve, 2 needle-free valves 104" and 26" from fixed male luer lock Approximate set length: 129" 328 cm. approx. Approximate priming volume: 24 mL	100
C42007E	10	 Gravity set, check valve, 4 needle-free valves 77", 52", 47" and 18" from 2-piece male luer lock Approximate set length: 119" 302 cm. approx. Approximate priming volume: 22 mL	50
C42011E 30-day lead time	20	 Gravity set, 1 needle-free valve 9" from 2-piece male luer lock Approximate set length: 104" 264 cm. approx. Approximate priming volume: 23 mL	100

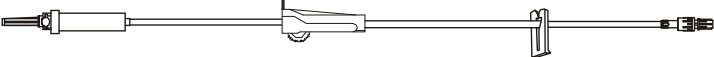
12.00 Gravity sets

12.06.03 Primary administration sets | No port sets







Administration sets for use as gravity sets. All sets are latex free. Some sets include MaxPlus needleless connectors and y-sites, SmartSite needle-free valves or VersaSafe split septum ports.

Model #	Drops	Description	Case quantity
MA3127 30-day lead time	15	 Administration set, male spin lock Approximate set length: 85" 216 cm. approx.	 50
MA3131	10	 Administration set, male spin lock Approximate set length: 84" 213.5 cm. approx.	 50
42000	20	 Gravity set, 2-piece male luer lock Approximate set length: 107" 271 cm. approx. Approximate priming volume: 20 mL	100
11619231 30-day lead time	60	 Gravity set, check valve, spin male luer lock Approximate set length: 47" 119 cm. approx. Approximate priming volume: 14 mL	 100
11620791 30-day lead time	20	 Gravity set, check valve, spin male luer lock Approximate set length: 47" 119 cm. approx. Approximate priming volume: 14 mL	 100

12.00 Gravity sets

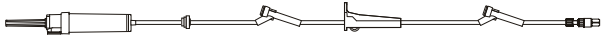
12.06.04 Primary administration sets | VersaSafe split septum sets

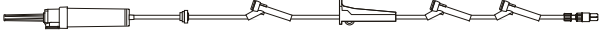



Administration sets for use as gravity sets. All sets are latex free. Some sets include MaxPlus needleless connectors and y-sites, SmartSite needle-free valves or VersaSafe split septum ports.

Model #	Drops	Description	Case quantity
42274E 30-day lead time	10	 Gravity set, check valve, 1 needle-free valve 84" from male luer lock, 1 split septum port 6" from 2-piece male luer lock Approximate set length: 104" 264 cm. approx. Approximate priming volume: 21 mL	50
10793510 30-day lead time	20	 Gravity set, 1 split septum port 9" from 2-piece male luer lock Approximate set length: 104" 264 cm. approx. Approximate priming volume: 22 mL	 100
10796811	20	 Gravity set, check valve, 2 split septum ports 87" and 9" from 2-piece male luer lock Approximate set length: 104" 264 cm. approx. Approximate priming volume: 22 mL	 100
10796812 30-day lead time	20	 Gravity set, check valve, 3 split septum ports 45", 32" and 9" from 2-piece male luer lock Approximate set length: 105" 267 cm. approx. Approximate priming volume: 23 mL	 100

12.00 Gravity sets

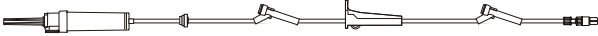
12.06.04 Primary administration sets | VersaSafe split septum sets

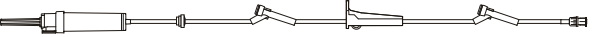
Administration sets for use as gravity sets. All sets are latex free. Some sets include MaxPlus needleless connectors and y-sites, SmartSite needle-free valves or VersaSafe split septum ports.

Model #	Drops	Description	Case quantity
10796813	60	 <p>Gravity set, check valve, 2 split septum ports 87" and 9" from 2-piece male luer lock</p> <p>Approximate set length: 104" 264 cm. approx.</p> <p>Approximate priming volume: 23 mL</p>	 100
10807856	10	 <p>Gravity set, check valve, 2 split septum ports 78" and 4" from fixed male luer lock</p> <p>Approximate set length: 104" 264 cm. approx.</p> <p>Approximate priming volume: 23 mL</p>	 100

Index

Set #	Page #	Set #	Page #	Set #	Page #	Set #	Page #
19MMTP	5	2430-0500	124	20337E	86	30920-07	156
2000E	1, 5, 55	2432-0007	124	20338E	86	31202E	63
2106-0500	104	2433-0007	147	20350E	21, 44	31262E	63
2110-0500	153	2434-0007	124	20511E	30	37262E	63
2111-0500	153	2440-0600	105	20519E	30	4900-0000	206
2120-0007	154	2441-0007	105	20558E	1	41134E	237
2120-0500	153	2441-0600	105	21028E	21	41135E	237
2121-0500	130, 154	2442-0007	105, 111	21059E	61	41137E	237
2125-0500	141	2443-0600	105, 124	22059E	61	41173E	237
2126-0007	154	2444-0007	110, 118	25202E	30	41177E	237
2126-0500	153	2447-0007	106, 141	25203	34	42000	242
2129-0500	153	2447-0600	106, 141	25205	34	42002-07	226
2130-0500	130	2448-0600	106	25206	34	42006-07	226
2131-0500	120, 133	2449-0600	106	25207E	30	42081E	222
2140-0600	111	2450-0500	99	25208E	30	42082E	222
2141-0600	111	2455-0500	147	28004E	197	42085	223
2147-0600	111, 141	2461-0007	117	28018	198	42133E	237
2177-0000	123	2462-0007	117	28026	198	42163E	218
2200-0500	152	2463-0007	113	28035-0500	200	42193E-0500	238
2201	5	2465-0007	11, 113, 125, 139	28053	192	42233E	238
2202-0007	132	2466-0007	11, 118, 139	28063E	189	42273E	238
2202-0500	132	2477-0000	121	28080	194	42274E	238, 243
2202E	5	2477-0007	121	28080E	193	42293E	238
2203-0500	135, 138	2478-0000	121	28117	200	42433E	239
2203E	5	2929-0500	153	28117E	197	42434E	239
2204-0007	152	2941-0500	152	28125	198	42493E	239
2205E	5	2942-0500	152	28208	190	42502E	211
2206-0007	137	20019E	55, 85	28216	190, 196	42503E	211
2260-0500	118	20021E	85	28265	200	42504E	211
2278-0500	122	20022	97	28273E	195	42511E	211
2280-0000	144	20027E	20	28293E	197	42519E	211
2300E-0500	7	20028E	20	28493E	197	42521E	212
2309E	7	20029E	20	30202E	61	42933E	224
2401-0500	145	20035E	85	30203E	86	47177E	239
2403-0000	145	20037E	85	30204E	62	47233E	239
2403-0007	145	20038E	85	30205E	62	70027	207
2406-0500	99	20039E	55, 85	30212E	62	70200	3, 7
2408-0500	99	20041E	40, 55	30262E	62	70804	3, 7
2410-0500	145	20043E	40	30263E	62	71633E	181
2411-0500	145	20049E	86	30822	97	71980-0500	169
2412-0500	124	20051E	40	30842E	62	72001E	181
2414-0500	134	20053E	40	30843E	160	72003	185
2420-0007	145	20057E	60	30853	160	72012M	186
2420-0500	146	20059E	60	30862-0500	98	72013E	181
2421-0500	146	20060E	60	30863	160	72013KE	181
2425-0500	141	20061E	60	30873	160	72013KM	186
2426-0007	146	20062E	61	30883	161	72023E	181
2426-0500	146	20127E	20	30893	45, 161	72023KE	182
2428-0007	99	20128E	20	30910	98	72023M	186
2429-0007	146	20129E	25	30914	98	72033E	182
2429-0500	147	20159E	61	30916-07	156	72033M	186

Index

Set #	Page #	Set #	Page #	Set #	Page #	Set #	Page #
72103E	163	10010761	137	10013890	118	10061661	13, 115, 140
72103M	165	10010871	107, 113	10013902	21, 44	10062818	119, 122
72104KE	163	10010903	222	10014035	107	10073124	240
72104KM	165	10010912	63	10014081	201	10074281	108, 115
72163E	163	10010971	64	10014472	35	10108961	101
72163E-0003	163	10010977	64	10014692	64	10108964	31
72163M	165	10010983	87	10014766	87	10137405	115
72165E	164	10010985	201	10014813	42	10137407	223
72193E	164, 171	10011087	219, 229	10014854	171	10142568	101
72213	207	10011253	55, 87	10014855	12, 114, 139	10178573	148
72213N	207	10011265	212	10014881	10, 203	10237425	27
72215N	207	10011301	137	10014881T	10	10241342	45
72303-0500	176	10011433	191	10014913	156	10321213	13, 140
72313E	166, 174	10011462	154	10014914	156	10321214	157
72323E	171	10011611	212, 224	10014915	156	10373772	93
72323M	173	10011652	142	10014916	157	10382963	101
72433E	182	10011865	25	10014917	157	10387509	223
72544	176, 178	10011881	92	10014918	157	10404198	148
72623KE	182	10012143	64	10015012	108, 114, 125	10406194	116, 126
72633E	182	10012144	147	10015048	114	10406890	87
72900E	183	10012182	100	10015104	221, 224	10408730	149
72900M	187	10012212	170	10015171	240	10425228	213
72923	167, 172	10012213	68	10015294	148	10425229	213
72923E	166	10012240-0500	4	10015312	100	10561554	134
72943	185	10012241-0500	4	10015414	122	10657768	185
72953	167	10012283	107, 125, 142	10015415	169	10689602	159
72963E	183	10012293	107, 142	10015485	69	10779313	112
72964E	183	10012392-0500	4	10015487	35	10784614	14, 167, 179
72980E	168	10012463	27	10015488	87	10793510	243
72980M	170	10012476	40	10015492	223	10794983	93
72981E	168	10012496	27	10015501	205	10796811	243
72983	180	10012529	176, 178	10015612	157	10796812	243
79980E	168	10012562	34	10015645	148	10796813	244
82005E	218, 229	10012564	219, 229	10015649	100	10796814	66
82104E	218	10012645	147	10015817	92	10796815	22
82113E	218	10012812	177	10015861	12, 115, 140	10798696	158
82114E	218	10012866	25	10015862	12, 115, 140	10798697	158
82115E	219, 229	10013034	100	10015863	14, 166, 179	10798703	158
9385-0500	206	10013037	121	10015896	101	10800173	161
9387-0500	206	10013072	114	10016072	31	10800174	161
9391-0200	3	10013182	183	10016073	207	10800175	161
9987-0000	206	10013186	147	10016242	201	10800176	162
10010453	113, 131	10013203	34	10026645	14, 167, 179	10800177	162
10010454	113, 125	10013361	11, 139	10026685	69	10802688	240
10010483	144	10013363	14, 179	10031773	148	10807851	22
10010511	86	10013364	10, 203	10031776	93	10807853	22
10010525	92	10013364T	10	10037031	219, 227, 229	10807854	66
10010541	106	10013365	4	10037032	219, 227, 230	10807855	89
10010570	25	10013784	41	10050186	212	10807856	244
10010721	187	10013854	11, 118	10050187	213	10807857	220
10010741	239	10013889	114	10053857	240	10807859	89

Index

Set #	Page #	Set #	Page #	Set #	Page #	Set #	Page #
10813621	102	11499816	187	C42001	228	ME1232	43
10817920	108, 142	11499817	170	C42002E	241	ME1233	43
10821753	108, 116	11501182	187	C42006E	214	ME1234	91
10839681	93	11501183	188	C42007E	241	ME1242	68
10844551	223	11522558	143	C42010E	215	ME1246	68
10849550	220	11532269	116, 126	C42011E	241	ME1247	68
10863358	135	11582773	102	C42012E	215	ME1248	68
10869591	223	11582774	208	C42013E	215, 216	ME1250	23
10879046	213	11590099	64	C70101	202	ME1251	91
10879047	149	11590100	151	C72101	185	ME1253	91
10879391	149	11607532	220	C72102E	184	ME1254	23
10896354	93	11607704	151	C72108E	184	ME1255	23
10912433	158	11607787	109	C72109E	184	ME1256	23
10927766	149	11608375	69	C72110E	164	ME2010	92
10933805	149	11609481	116, 126	C72113E	164	ME2017	92
10934345	102	11609826	240	M4018	26	ME2020	97
10942011	152	11610341	10, 203	M4020	26	ME2050	92
10942968	183	11612593	129	M4025	33	ME2059	97
11045328	110, 129	11613191	109, 117, 127, 143	M4026	33	ME2064	24
11059727	214	11619231	242	M4058	33	ME2068	68
11059728	214	11619427	241	M4060	33	ME2069	24
11059729	102	11620791	242	MA3090	234	ME2070	24
11063735	110	11627697	214	MA3127	242	ME2071	24
11088483	94	8881135609	162	MA3131	242	ME5301	56
11089893	199	8881682101	162	MA3137	226	ME5302	56
11118122	109, 126	8881682119	162	MA3138	226	ME5303	56
11130148	120, 130	A492	206	MB3105	234	ME5304	56
11132982	175	C20014	45, 69	MB3107	234	MFS100	231
11133698	136	C20016	94	MB3110	226	MFS102	231
11141556	165, 173	C20022	69	MBC6000	2	MFS104	44
11147991	154	C20025	69	MBC6008	2	MFS106	44
11147992	104	C20032	98	MC3102	234	MFS107	44
11147994	216	C24101E	127, 134, 138	ME1001	90	MFS120	226, 231
11171447	150	C24103E	127	ME1021	90	MFS121	231
11202651	89	C24104E	103	ME1028	90	MFS124	231
11202652	89	C24105E	151	ME1032	90	MFS125	232
11202653	130	C24106E	103	ME1046	43	MFS132	232
11225954	171	C24107E	103	ME1047	43	MFS133	232
11258587	167	C24111E	151	ME1048	90	MFS134	232
11258588	155	C24112	152	ME1050	91	MFS135	232
11275183	22	C24116E	151	ME1055	67	MFS136	233
11287205	150	C24117	119	ME1069	67	MFS137	233
11325478	155	C24119E	128	ME1110	91	MFS139	233
11325479	186	C25002E	88	ME1214	43	MFS140	233
11401542	112	C25004E	65	ME1222	97	MFS141	44
11404930	150	C25005E	88	ME1223	67	MM4000	7, 26
11419365	102	C25006	98	ME1224	67	MM4021	33
11426964	119	C25012	94	ME1225	23	MM4024	32
11426965	150	C25013E	41	ME1227	91	MM4300-1	28
11448964	208	C25015E	65	ME1229	67	MP1000	1
11484001	150	C30006	94	ME1230	67	MP1000A	1

Index

Set #	Page #	Set #	Page #	Set #	Page #	Set #	Page #
MP1000-C	1, 46	MP9017-C	77	MP9268-C	96	MX4439	29
MP2000	74	MP9027	77	MP9269-C	17	MX4440	29
MP2000-C	74	MP9027-C	78	MP9270-C	18	MX4441	210
MP2002	74	MP9081-A	71	MP9271-C	18	MX4443	235
MP2002-C	74	MP9081-C	71	MP9272-C	18	MX4449	209
MP2005	70	MP9081-SF	71	MP9273-C	18	MX4450	29
MP2005-C	70	MP9101	78	MP9274-C	19	MX4452	209
MP2202	74	MP9202	57	MP9275-C	96	MX5301	53
MP2202-C	75	MP9202-C	57	MPC-1A	3	MX5302	54
MP4000-C	28	MP9204	16	MPX5300-C	51	MX9037	58
MP4001-C	15, 28	MP9208-C	38	MPX5301-C	51	MX9059	58
MP5301	46	MP9209	16	MPX5302-C	51	MX9060	73
MP5301-A	46	MP9212-C	16	MPX5303-C	52	MX9076	58
MP5301-C	46	MP9213-C	71	MPX5304-C	52	MX9107	235
MP5302	47	MP9216-C	39	MPX5305-C	52	MX9128	235
MP5302-A	47	MP9218-C	78	MPX9100	72	MX9164	73
MP5302-C	47	MP9220-C	78	MPX9101	82	MX9165	83
MP5303	47	MP9221-C	39	MPX9101-C	82	MX9166	19
MP5303-A	48	MP9224	78	MPX9102-C	72	MX9167	84
MP5303-C	48	MP9229	79	MPX9102-SF-C	72	MX9171	19
MP5304-C	48	MP9230	57	MPX9103	72	MX9172	58
MP5305-C	48	MP9232-A	79	MPX9104	82	MX9175	59
MP5310-A	49	MP9232-C	79	MPX9105	83	MX9178	59
MP5310-C	49	MP9233-C	79	MPX9105-C	83	MX9181	84
MP5311-C	49	MP9234-C	17	MPX9107-C	83	MX9182	59
MP5312-A	49	MP9235-C	80	MPXT1001-C	36, 52	MX9407	217
MP5312-C	50	MP9236-A	80	MPXT1003-C	36, 53	MX9412	235
MP5313-A	50	MP9236-C	80	MPXT1004-C	36	MX9414	235
MP5313-C	50	MP9238-C	57	MPXT1005-C	36	MX9416	235
MP5314-C	50	MP9240-C	80	MPXT1006	37	MX9417	236
MP5315-C	51	MP9246-C	57	MPXT5301-C	37, 53	MX9424	236
MP9001	75	MP9247-C	39	MPXT5302-C	37, 53	MX9433	236
MP9001-A	75	MP9249-C	95	MS3101	234	MX9963	236
MP9001-C	75	MP9250-C	80	MS3500	208	MX9968	236
MP9002	70	MP9251-C	81	MS3500-15	208	MX9998	236
MP9002-A	70	MP9252-C	81	MS3542	225	MXT1003	37, 54
MP9002-C	70	MP9253-C	81	MT6000	204	MXT1004	38
MP9004	75	MP9254-C	17	MT6004	234	MXT1005	38
MP9004-A	76	MP9255-C	81	MV0400	4	MXT1006	38, 54
MP9004-C	76	MP9256-C	71	MV0500	8	MY0240	3
MP9004-NRC	76	MP9257-C	81	MV0510	8	MY3001	9
MP9008	15	MP9258-C	95	MV0600	8	MY3003	9
MP9009	15	MP9259-C	72	MV0700	8	MY3004	9
MP9009-C	16	MP9260-A	82	MX1002	1	MY8003	6
MP9014	76	MP9262-C	82	MX4410	210	MY8005	6
MP9014-A	76	MP9264-C	17	MX4412	210	MY8010	6
MP9014-C	77	MP9265-C	95	MX4414	29	MY8020	6
MP9017	77	MP9266-C	95	MX4416	217	MY8060	6
MP9017-B	77	MP9267-C	96	MX4436	210		



© 2013 CareFusion Corporation or one of its subsidiaries.
All rights reserved. AccuSlide, Alaris, MedSystem III, MaxPlus,
MaxPlus clear, MaxGuard, SmartSite, Texium and VersaSafe are
trademarks or registered trademarks of CareFusion Corporation
or one of its subsidiaries. All other trademarks are the property
of their respective owners. IV0033 (0113)

CareFusion
San Diego, CA

carefusion.com

