



MONTAGEANLEITUNG

GARTENHAUS NIKOSIA



GARTENHAUS NIKOSIA

- Holzart: Skandinavische Fichte unbehandelt
- Wandstärke: 28 mm
- Außenmaß: 290 x 290 cm
- Fundament: 270x270 cm
- Innenmaß: 264,4x264,4 cm
- Firsthöhe hinten: ca. 190 cm
- Firsthöhe vorne: ca. 219 cm
- Grundfläche: 7,3 m²
- Volumen: 14,6 m³
- Türen: 1 Doppeltür mit Ausschnitt für Echtglas



ALLGEMEINE HINWEISE

Lese vor Beginn des Aufbaus die komplette Montageanleitung, um eventuelle Unklarheiten vorab mit unserem Fachpersonal zu besprechen. Wir helfen dir - So muss das!



Telefon
05931 - 496 576 0



E-Mail
info@steda-online.de

Änderungen vorbehalten.



MONTAGEANLEITUNG

GARTENHAUS NIKOSIA



GRUNDPLAN

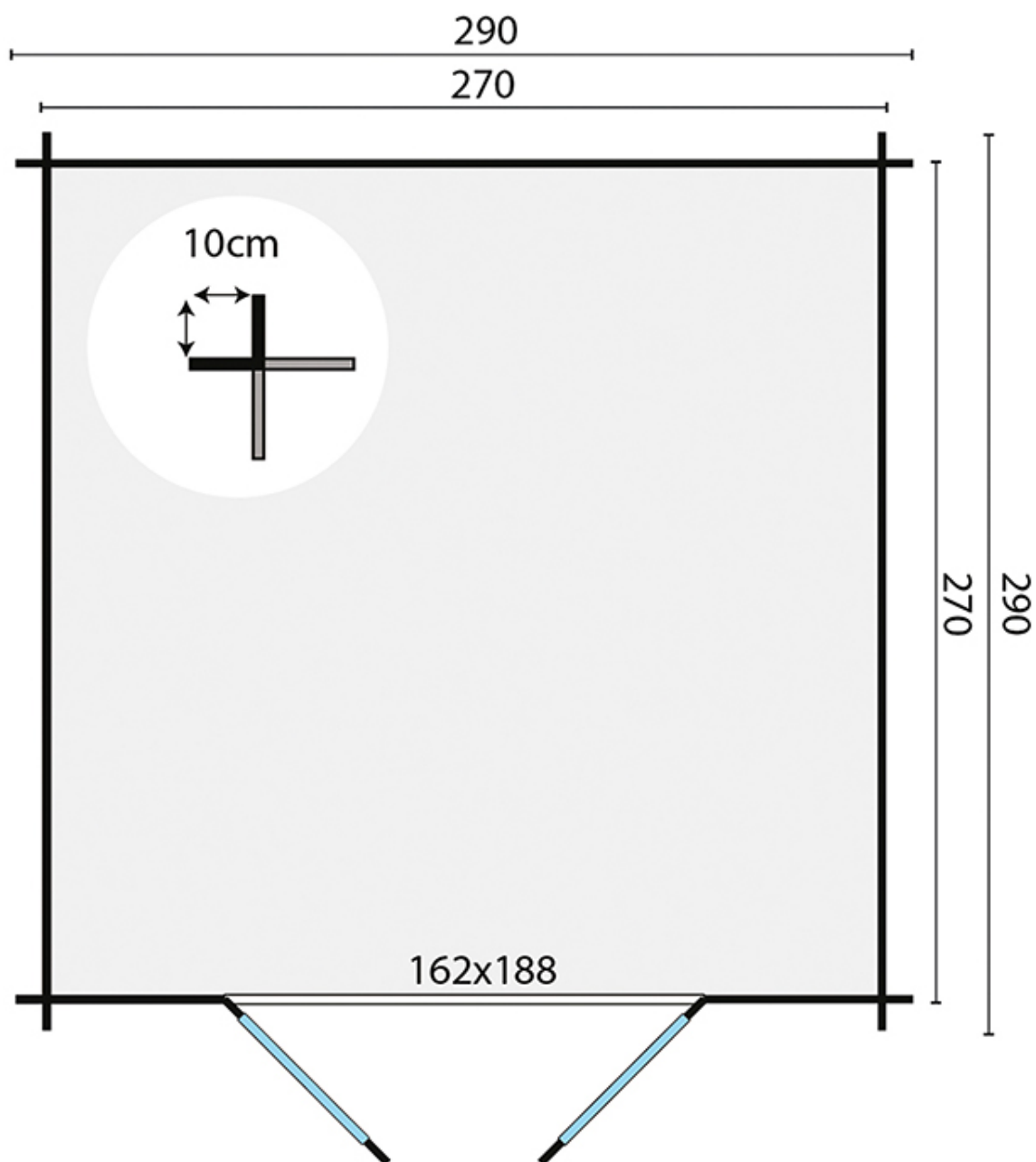

Änderungen vorbehalten.



MONTAGEANLEITUNG

GARTENHAUS NIKOSIA



— ANSICHT

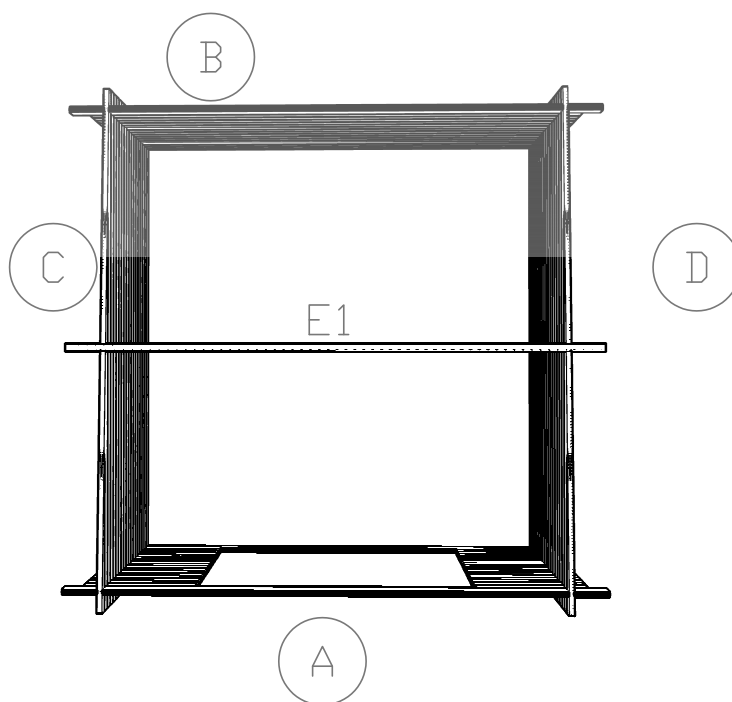
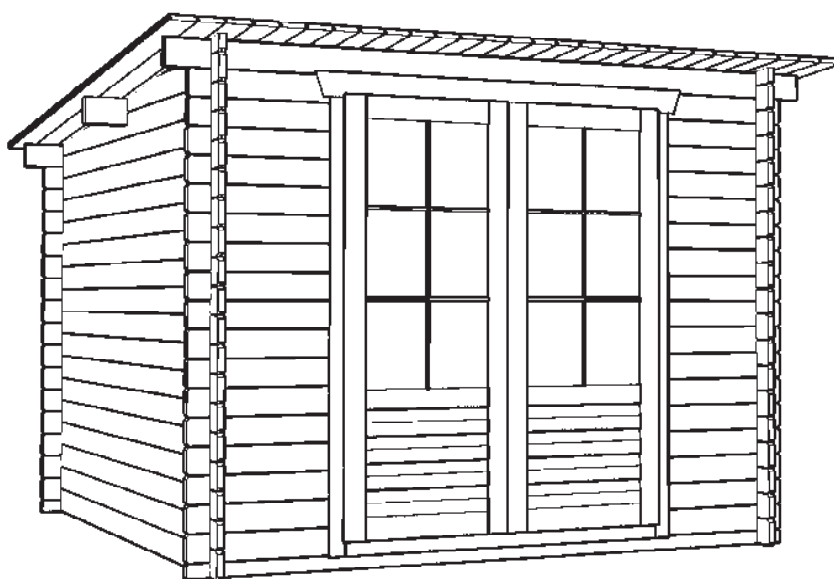

Änderungen vorbehalten.



MONTAGEANLEITUNG

GARTENHAUS NIKOSIA



VORDERANSICHT

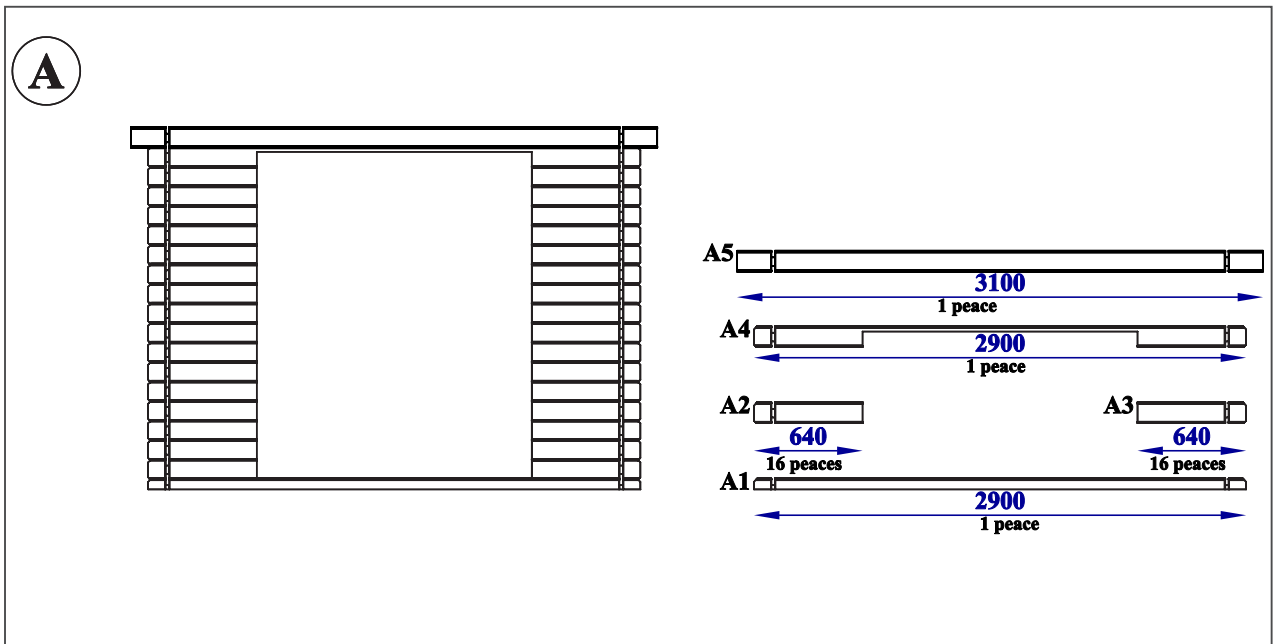

RÜCKANSICHT

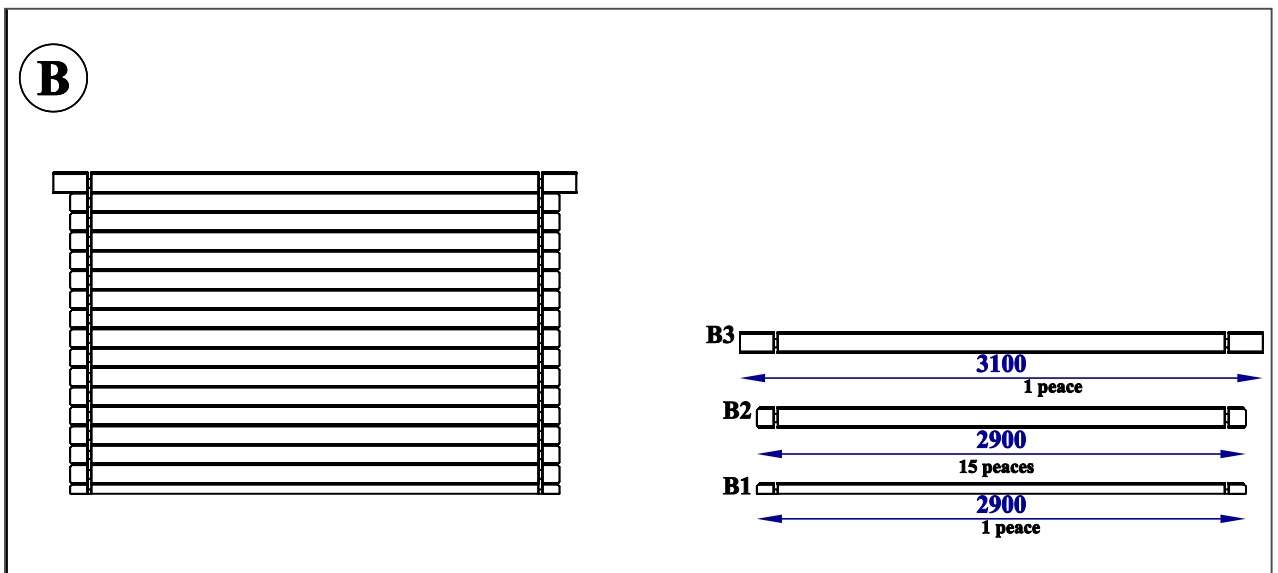



MONTAGEANLEITUNG

GARTENHAUS NIKOSIA



SEITENANSICHTEN

C

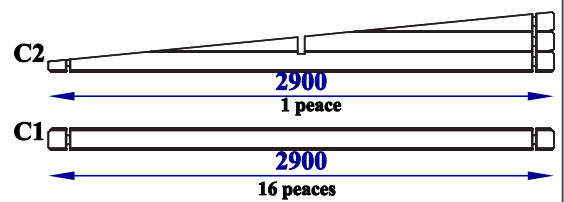
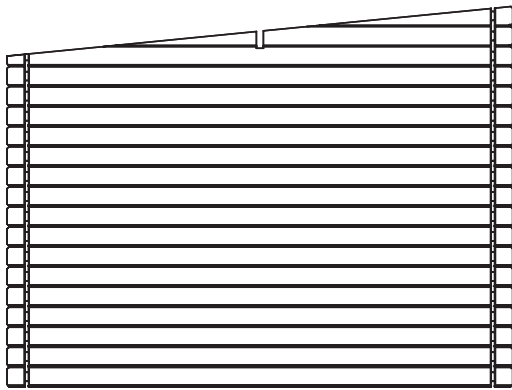

D

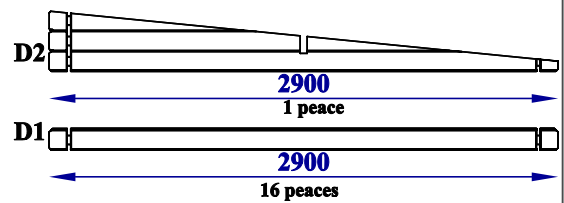
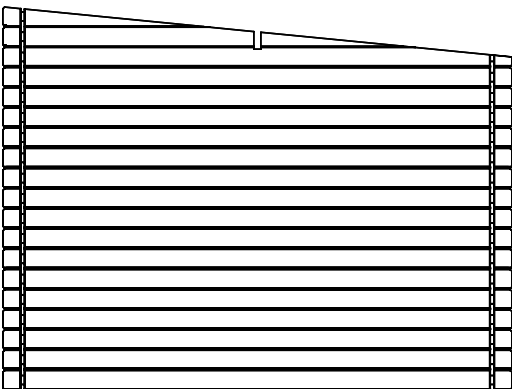



MONTAGEANLEITUNG

GARTENHAUS NIKOSIA



MONTAGE

1.

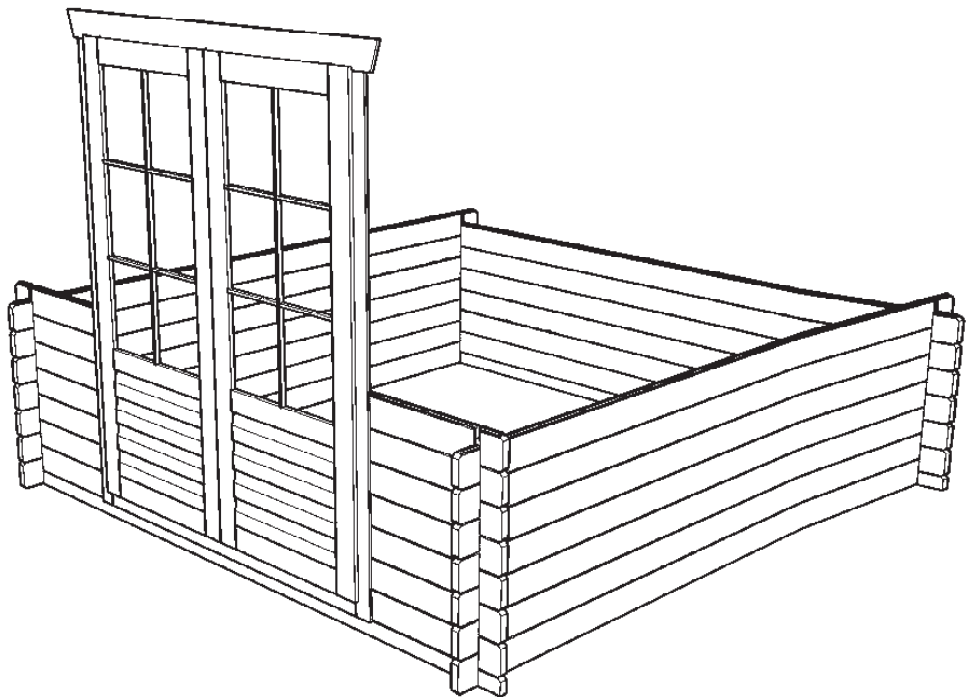

2.

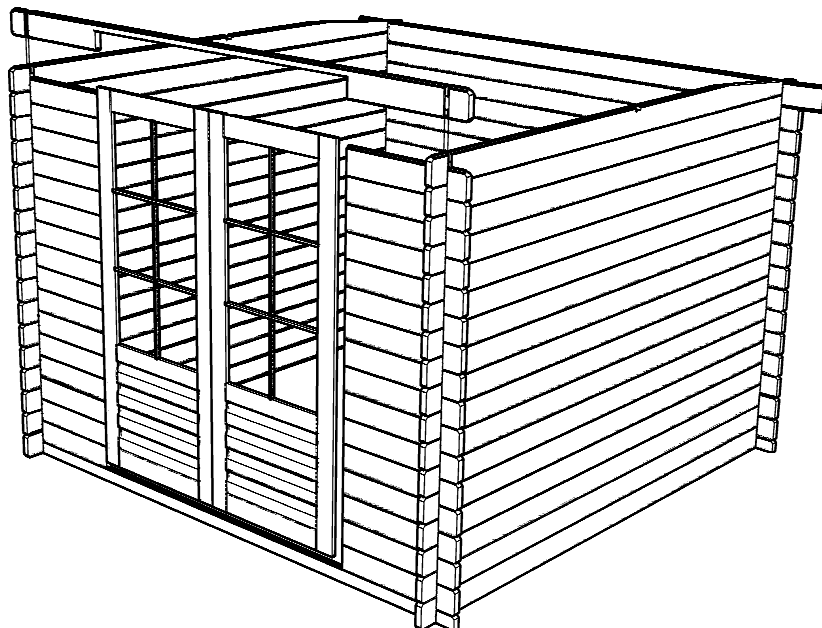

Änderungen vorbehalten.



MONTAGEANLEITUNG

GARTENHAUS NIKOSIA



MONTAGE

3.

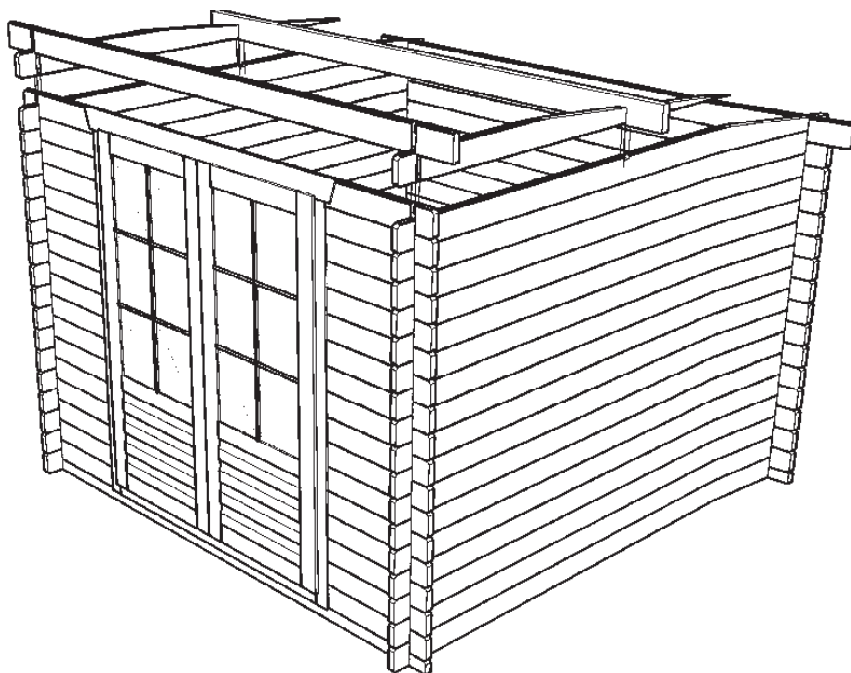

4.

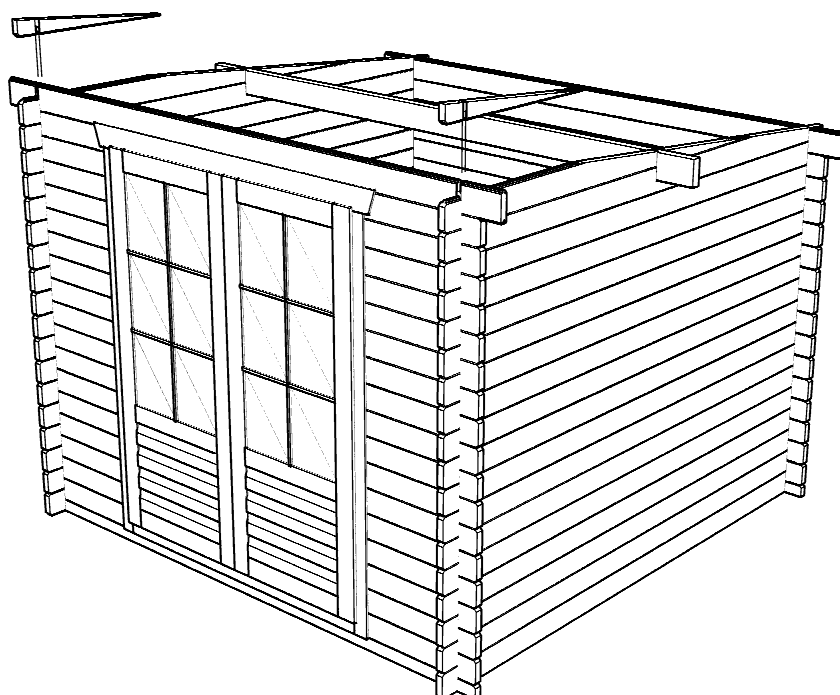

Änderungen vorbehalten.



MONTAGEANLEITUNG

GARTENHAUS NIKOSIA



HK-Lasur

Dekorative, lösemittelbasierte
Premium-Holzschutz-Lasur
für Holz im Freien



weiß* farblos* hemlock* pinie/lärche



kiefer eiche hell eiche rustikal mahagoni

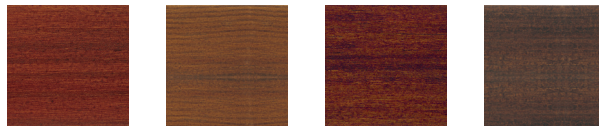

teak nussbaum kastanie palisander

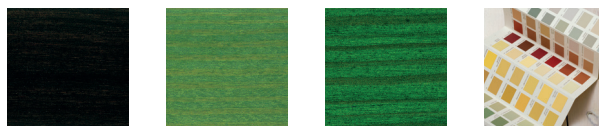

ebenholz salzgrün tannengrün Sonderfarbe

* Diese Farben nur für nicht direkt bewitterte Außenflächen wie Dachuntersichten usw. oder als Grundierung verwenden.

Biozide sicher verwenden. Vor Gebrauch stets Kennzeichnung und Produktinformationen lesen.

Holzschutzcreme

Lasur für den Schutz
und die Veredelung von
Holz im Außenbereich



eiche hell pinie/lärche kiefer

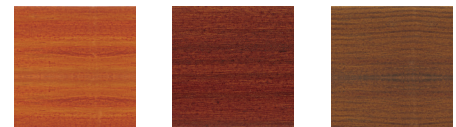

mahagoni teak nussbaum



palisander weiß silbergrau

Holzschutz- und Isoliergrund / UV-Schutz Lasur



Änderungen vorbehalten.



MONTAGEANLEITUNG

GARTENHAUS NIKOSIA



Deckfarbe

Wasserbasierte, hochdeckende
Wetterschutzfarbe für Holz im
Außenbereich



weiß*



hellgrau*



dunkelgrau



königsblau



friesenblau



moosgrün



flaschengrün



nussbraun



tabakbraun



rotbraun



schwed. rot



maisgelb



goldgelb



schwarz



hellelfenbein*



skand. rot



anthr. grau



Sonderfarbe

* Bei diesen Farben ist zusätzlicher
Isoliergrund nötig. Bei dunklen
Deckfarben kann es aufgrund starker
Sonnenanziehung zur Trocknung des
Holzes und damit verbunden, zur
Rissbildung kommen.