



MONTAGEANLEITUNG

GARTENHAUS KORFU



GARTENHAUS KORFU

- Holzart: Nordisches Fichtenholz unbehandelt
- Wandstärke: 44 mm
- Außenmaß: 575x575 cm
- Vordach: +200 cm
- Firsthöhe: ca. 277 cm
- Grundfläche: 33 m²
- Umbauter Raum: 82,5 m³
- Türen: 1 Doppeltür mit Ausschnitt für Echtglas
- Fenster: 3 Doppelfenster aus Echtglas zum Öffnen



ALLGEMEINE HINWEISE

Lese vor Beginn des Aufbaus die komplette Montageanleitung, um eventuelle Unklarheiten vorab mit unserem Fachpersonal zu besprechen. Wir helfen dir - So muss das!



Telefon
05931 - 496 576 0



E-Mail
info@steda-online.de

Änderungen vorbehalten.



MONTAGEANLEITUNG

GARTENHAUS KORFU



— GRUNDPLAN

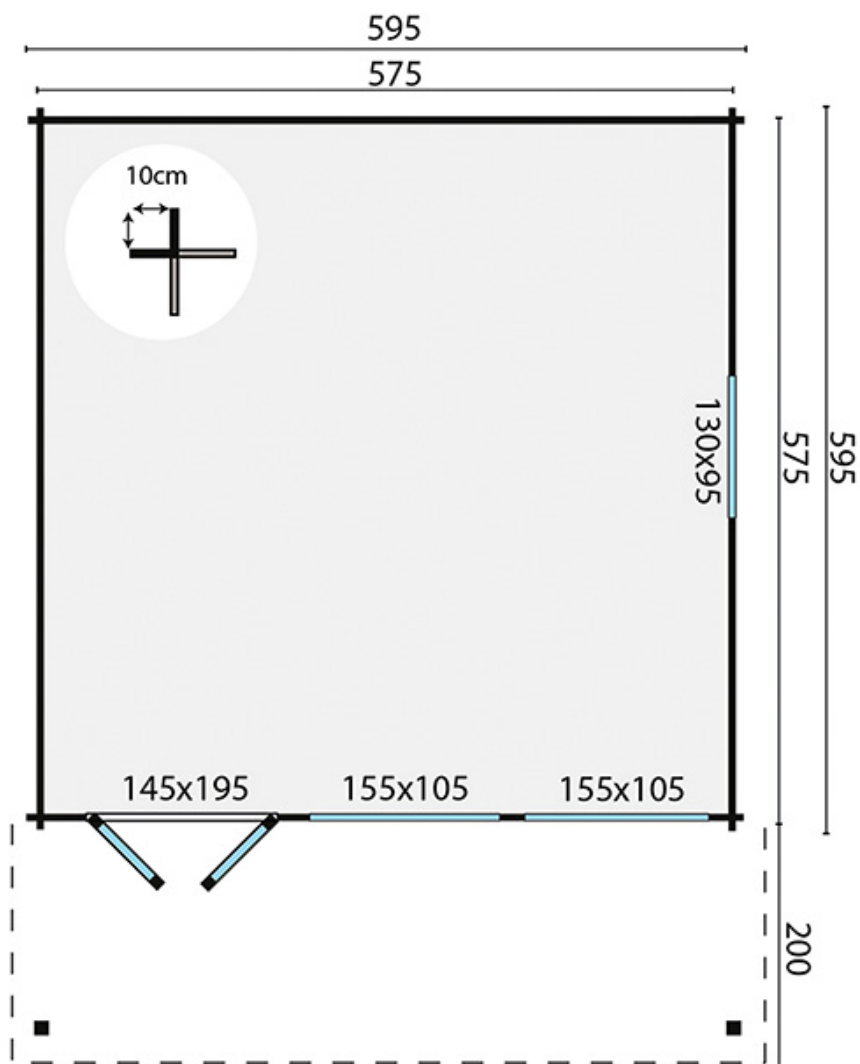

Änderungen vorbehalten.



MONTAGEANLEITUNG

GARTENHAUS KORFU



— ANSICHT

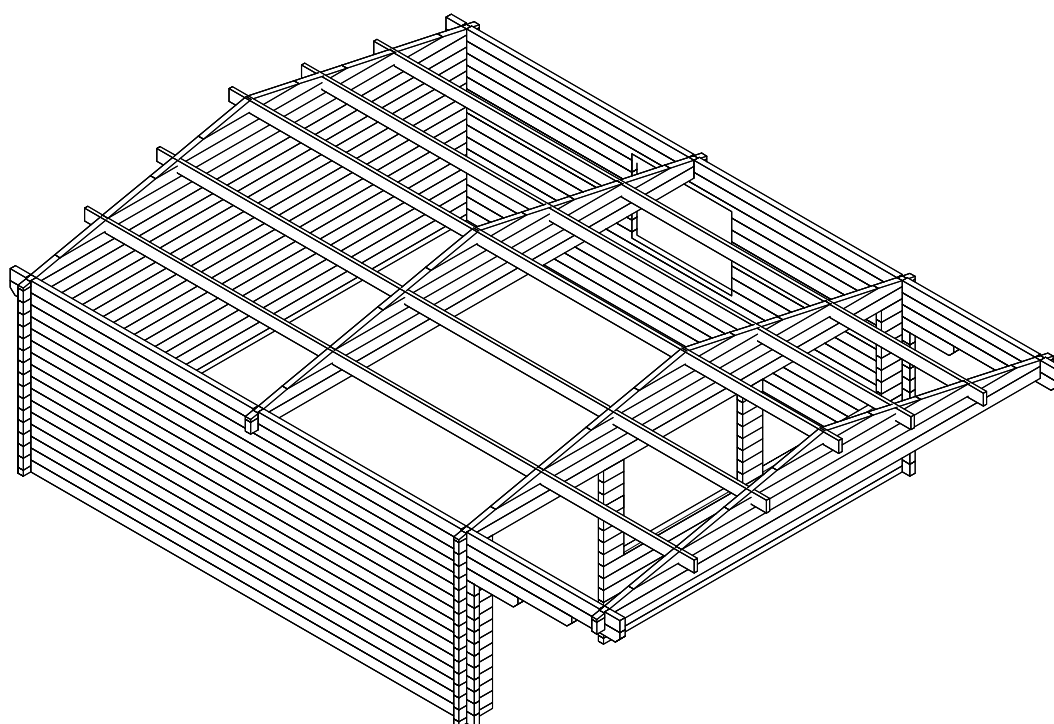
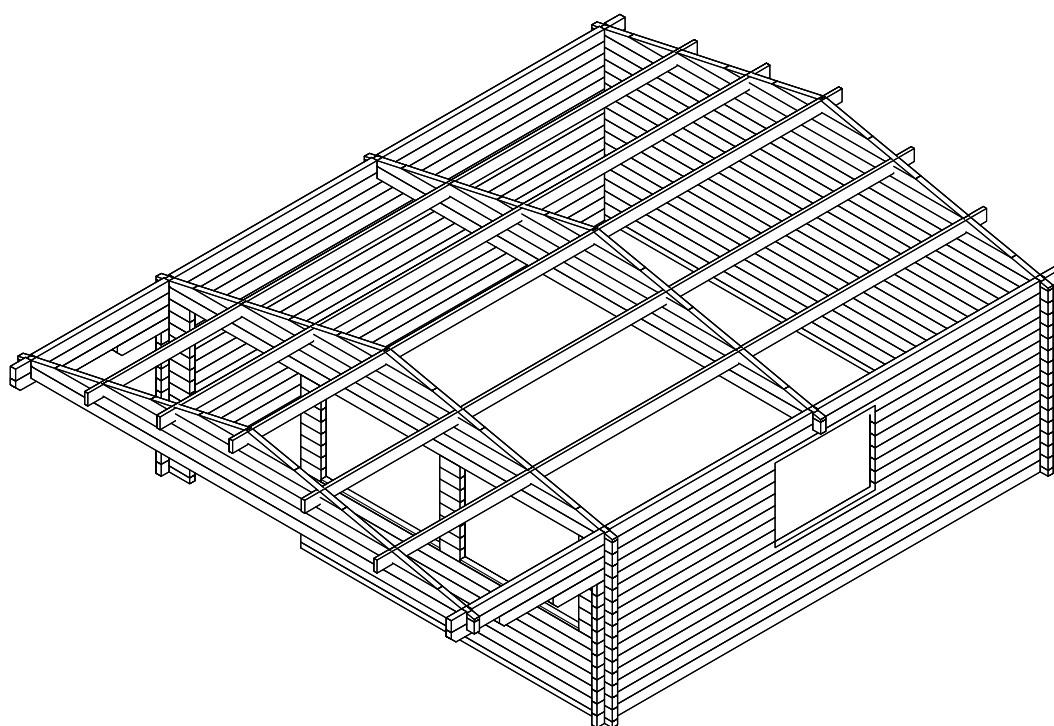

Änderungen vorbehalten.



MONTAGEANLEITUNG

GARTENHAUS KORFU



ANSICHT

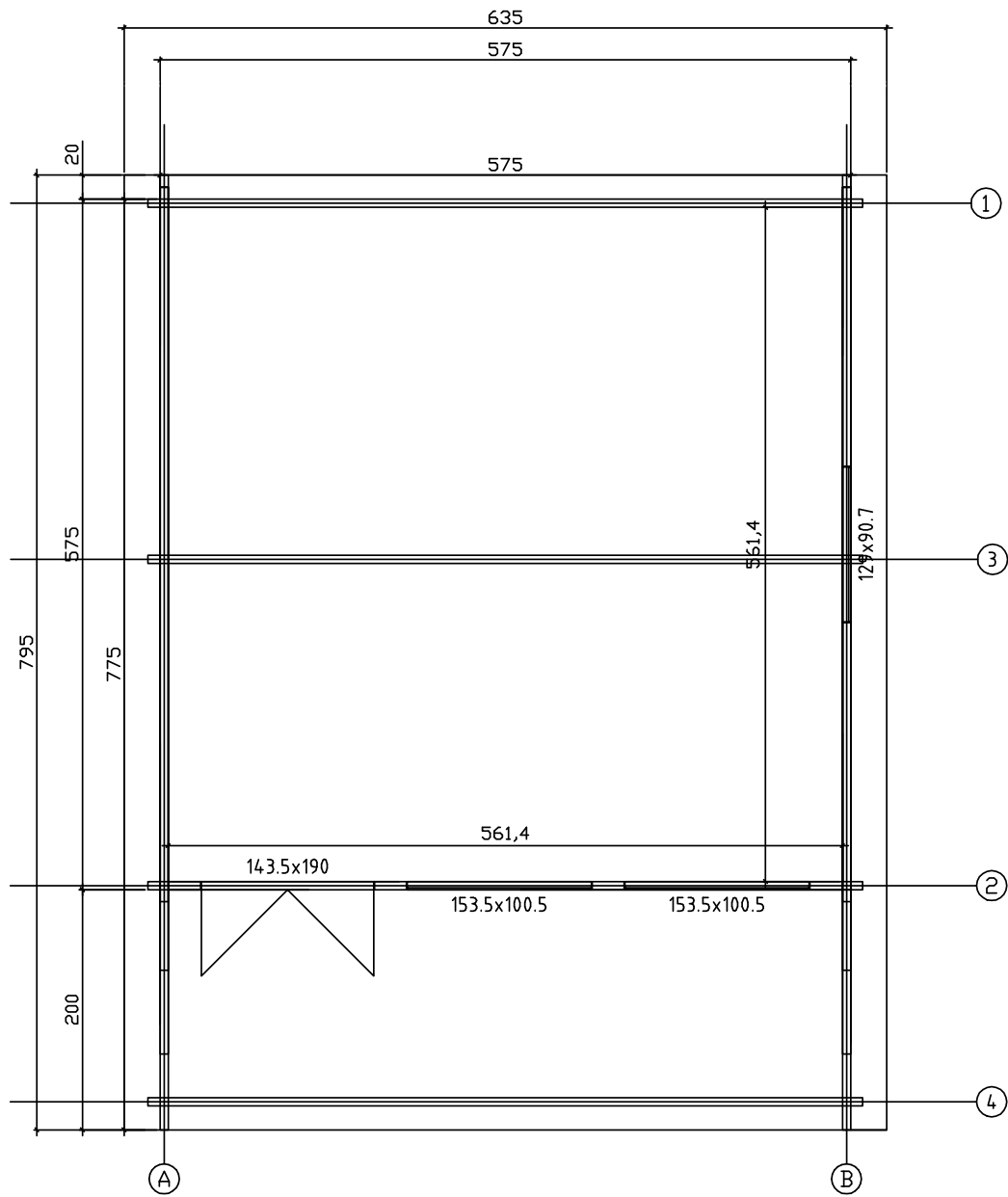

Änderungen vorbehalten.



MONTAGEANLEITUNG

GARTENHAUS KORFU



VORDERSEITE

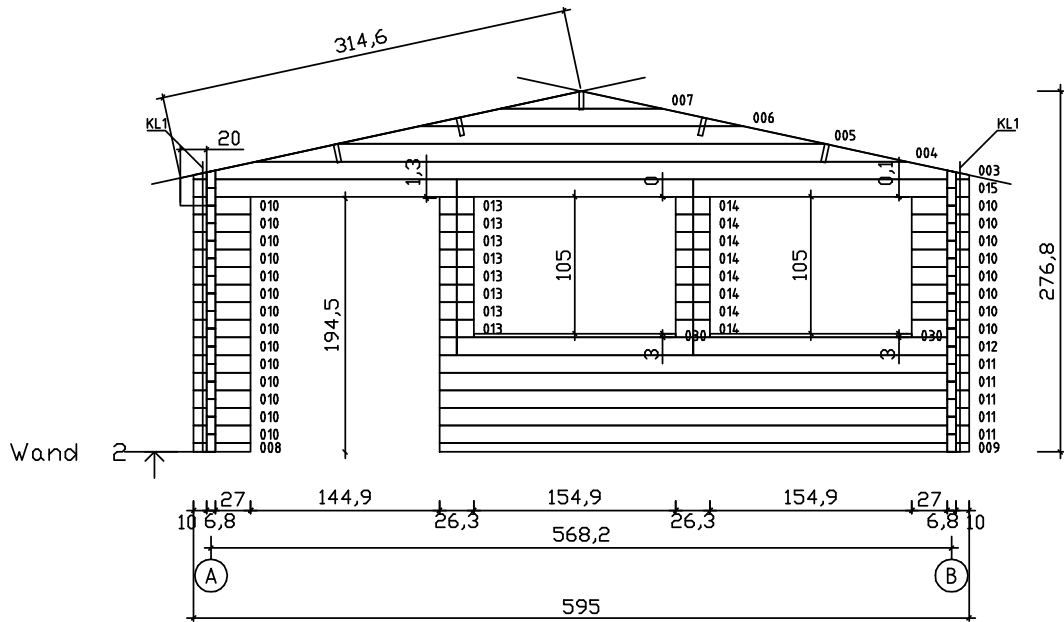

RÜCKSEITE

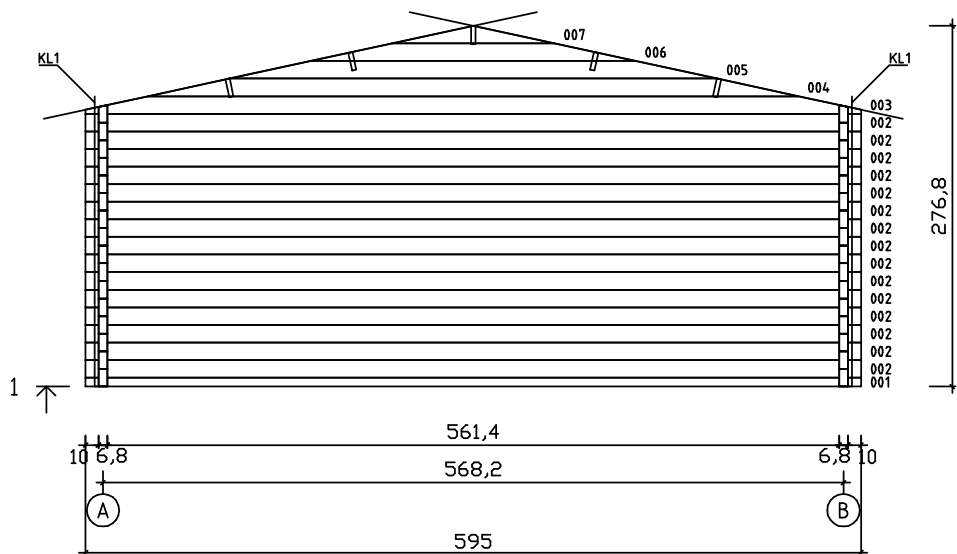

Änderungen vorbehalten.







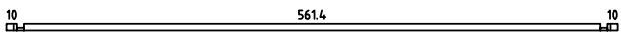
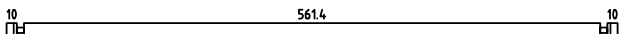
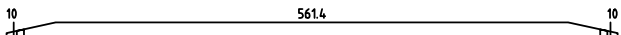
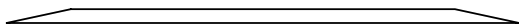
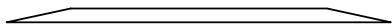
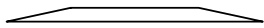

MONTAGEANLEITUNG

GARTENHAUS KORFU

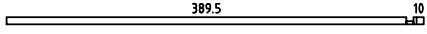

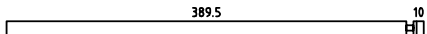
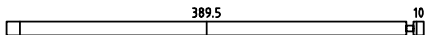
STÜCKLISTE

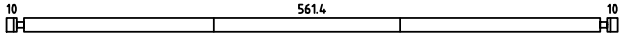
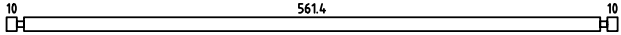
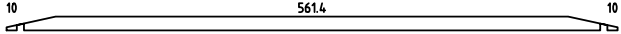
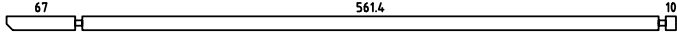
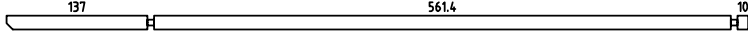
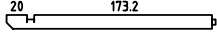
Pos	Drawing	Pcs	Profile (cm)	Length (cm)
001		1	6.8x6.8	595
002		15	6.8x13.5	595
003		2	6.8x13.5	595
004		4	6.8x13.5	499
005		4	6.8x13.5	374.3
006		4	6.8x13.5	249.5
007		4	6.8x13.5	124.8
008		1	6.8x6.8	43.8
009		1	6.8x6.8	406.3
010		22	6.8x13.5	43.8
011		5	6.8x13.5	406.3
012		1	6.8x13.5	406.3
013		8	6.8x13.5	26.3
014		8	6.8x13.5	26.3
015		1	6.8x13.5	595
016		20	6.8x13.5	595
017		2	6.8x13.5	595
018		1	6.8x13.5	652
019		1	6.8x13.5	722
020		2	6.8x13.5	203.4

Änderungen vorbehalten.



MONTAGEANLEITUNG

GARTENHAUS KORFU



STÜCKLISTE

020		2	6.8x13.5	203.4
021		2	6.8x13.5	591.6
022		1	6.8x13.5	475
023		1	6.8x13.5	320
024		1	6.8x13.5	595
025		11	6.8x13.5	232.3
026		1	6.8x13.5	289.3
027		1	6.8x13.5	722
028		1	6.8x13.5	475
029		1	6.8x13.5	320
030		2	6.8x2.9	154.9
PR1		4	4.3x14.5	795
PR2		1	4.3x14.5	795
	WINDOW 153.5x100.5	2		
	WINDOW 129x90.7	1		
	DOOR 143.5x190	1		



MONTAGEANLEITUNG

GARTENHAUS KORFU



HK-Lasur

Dekorative, lösemittelbasierte
Premium-Holzschutz-Lasur
für Holz im Freien



weiß* farblos* hemlock* pinie/lärche



kiefer eiche hell eiche rustikal mahagoni

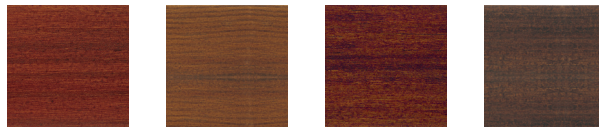

teak nussbaum kastanie palisander

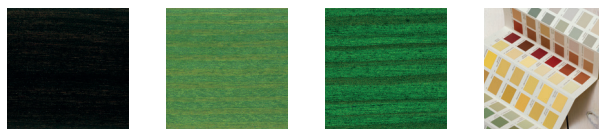

ebenholz salzgrün tannengrün Sonderfarbe

* Diese Farben nur für nicht direkt bewitterte Außenflächen wie Dachuntersichten usw. oder als Grundierung verwenden.

Biozide sicher verwenden. Vor Gebrauch stets Kennzeichnung und Produktinformationen lesen.

Holzschutzcreme

Lasur für den Schutz
und die Veredelung von
Holz im Außenbereich



eiche hell pinie/lärche kiefer



mahagoni teak nussbaum



palisander weiß silbergrau

Holzschutz- und Isoliergrund / UV-Schutz Lasur



Änderungen vorbehalten.



MONTAGEANLEITUNG

GARTENHAUS KORFU



Deckfarbe

Wasserbasierte, hochdeckende
Wetterschutzfarbe für Holz im
Außenbereich



weiß*



hellgrau*



dunkelgrau



königsblau



friesenblau



moosgrün



flaschengrün



nussbraun



tabakbraun



rotbraun



schwed. rot



maisgelb



goldgelb



schwarz



hellelfenbein*



skand. rot



anthr. grau



Sonderfarbe

* Bei diesen Farben ist zusätzlicher
Isoliergrund nötig. Bei dunklen
Deckfarben kann es aufgrund starker
Sonnenanziehung zur Trocknung des
Holzes und damit verbunden, zur
Rissbildung kommen.