



MONTAGEANLEITUNG

GARTENHAUS HAWAII



GARTENHAUS HAWAII

- Holzart: Nordisches Fichtenholz unbehandelt
- Wandstärke: 44 mm
- Außenmaß: 500x500 cm
- Vordach: +90 cm
- Firsthöhe: ca. 293 cm
- Grundfläche: 23 m²
- Umbauter Raum: 57,4 m³
- Türen: 1 Doppeltür mit Ausschnitt für Echtglas
- Fenster: 2 Doppelfenster aus Echtglas zum Öffnen



ALLGEMEINE HINWEISE

Lese vor Beginn des Aufbaus die komplette Montageanleitung, um eventuelle Unklarheiten vorab mit unserem Fachpersonal zu besprechen. Wir helfen dir - So muss das!



Telefon
05931 - 496 576 0



E-Mail
info@steda-online.de

Änderungen vorbehalten.



MONTAGEANLEITUNG

GARTENHAUS HAWAII



— ANSICHT

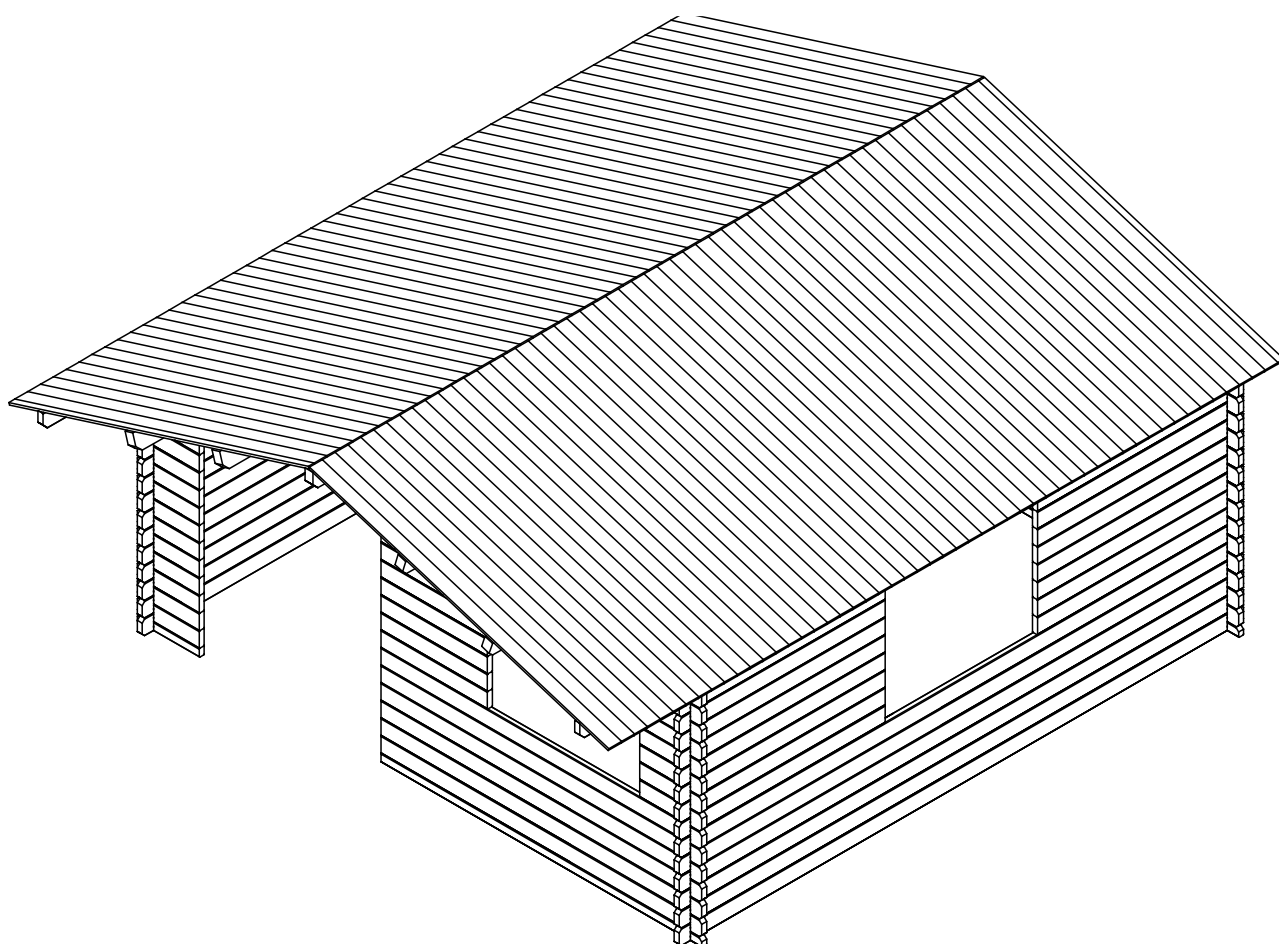

Änderungen vorbehalten.



MONTAGEANLEITUNG

GARTENHAUS HAWAII



GRUNDPLAN

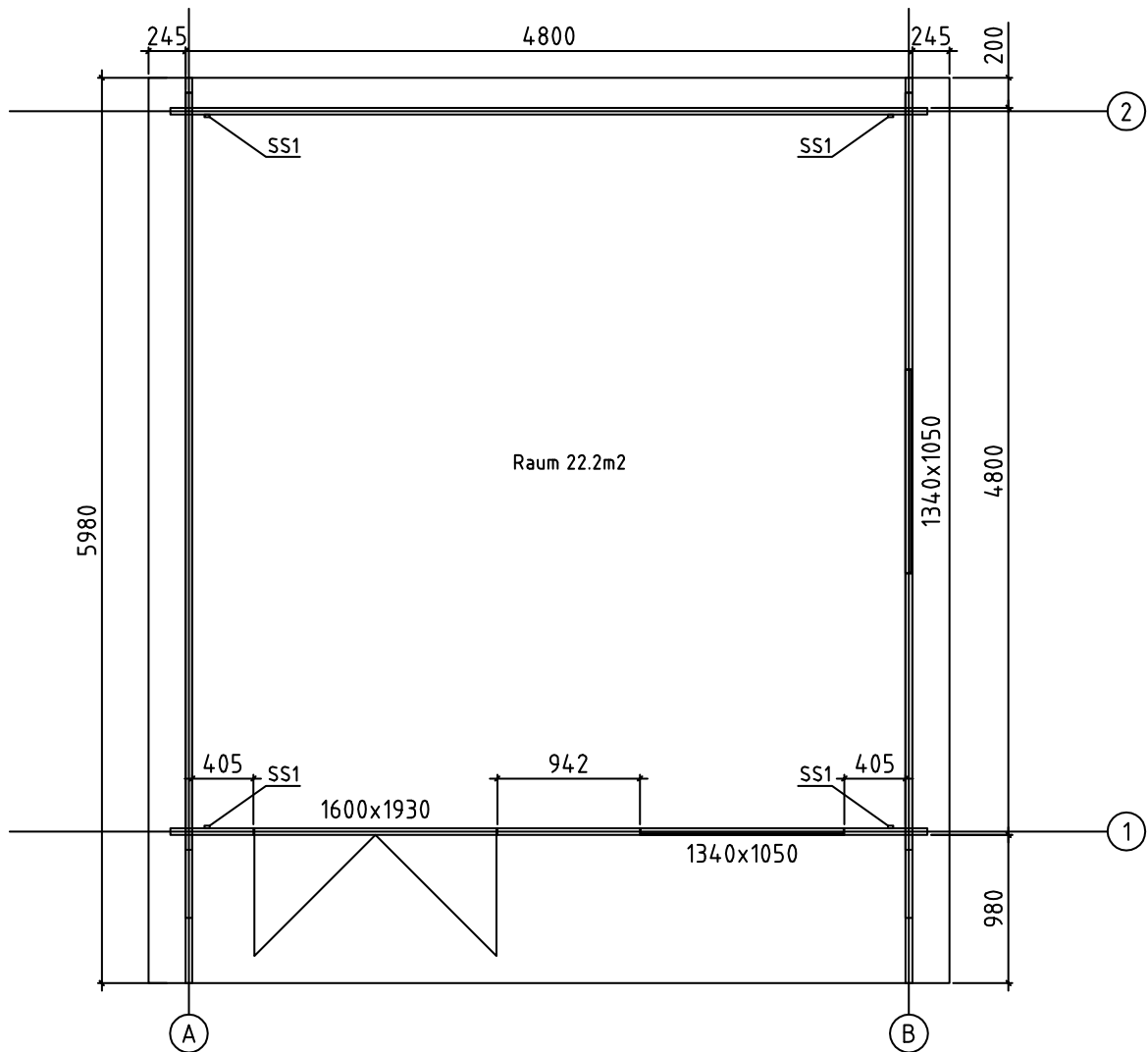

Änderungen vorbehalten.



MONTAGEANLEITUNG

GARTENHAUS HAWAII



SEITENANSICHTEN

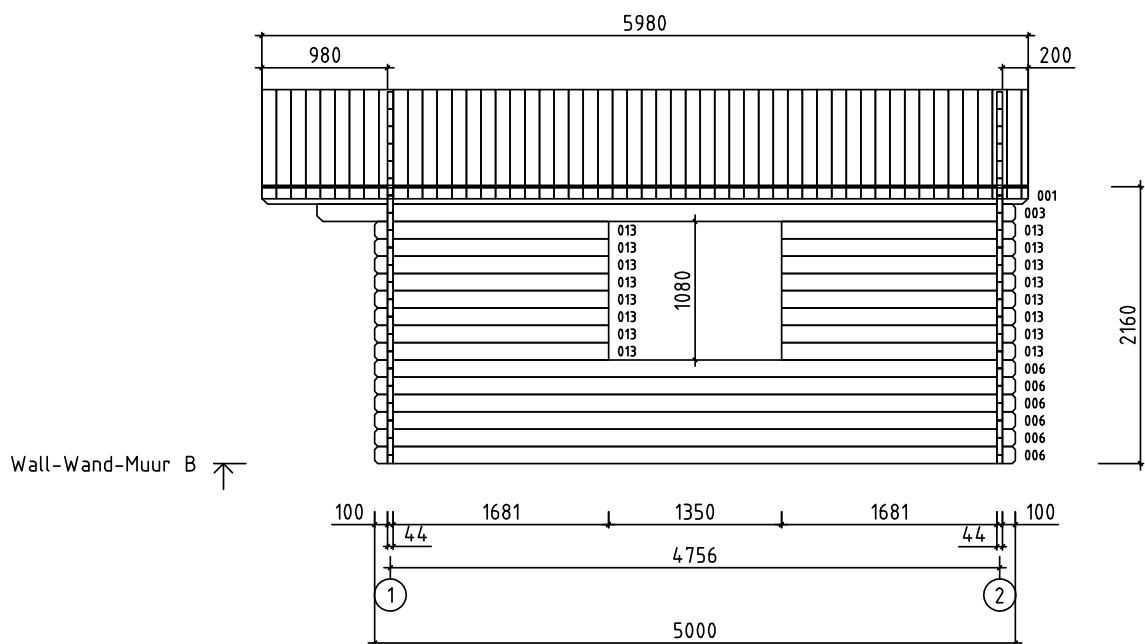
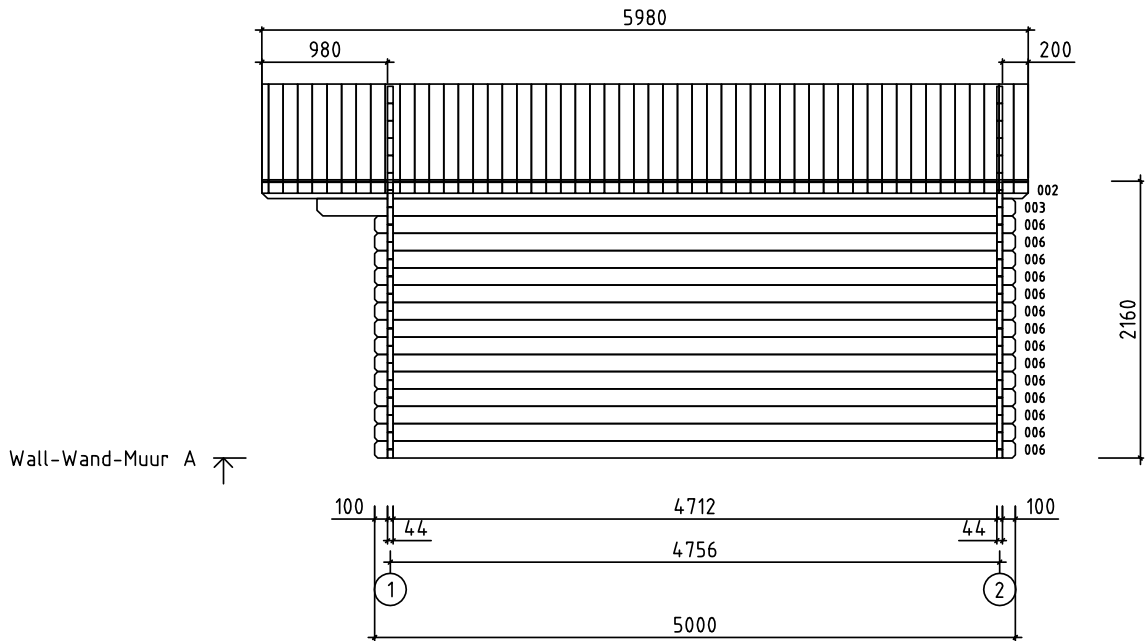

Änderungen vorbehalten.



MONTAGEANLEITUNG

GARTENHAUS HAWAII



VORDERSEITE

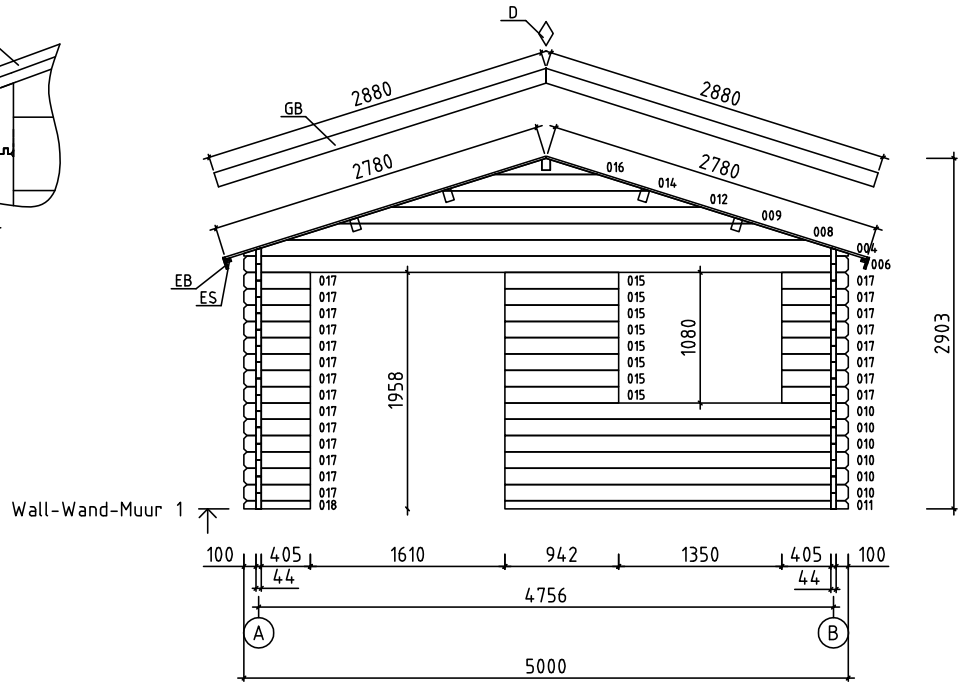
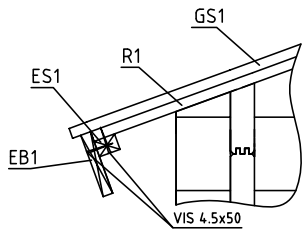

RÜCKSEITE

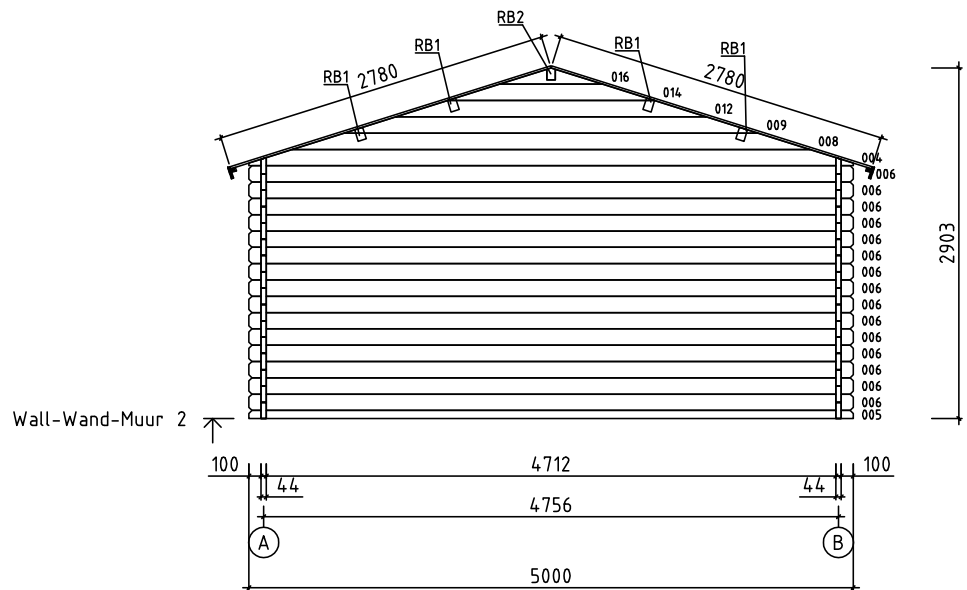

Änderungen vorbehalten.



MONTAGEANLEITUNG

GARTENHAUS HAWAII



STÜCKLISTE

Pos	Specification-Bestimmung-Omschrijving	Pcs	Profile (mm)	L (mm)
001	980 4712 200	1	44x135	5980
002	980 4712 200	1	44x135	5980
003	550 4712 100	2	44x135	5450
005	100 4712 100	1	44x68	5000
006	100 4712 100	36	44x135	5000
007	100 4856 SPARE BEAM-ERZATZBOHLE-VOORRAADPLANK	1	44x135	5000
010	2697 100	6	44x135	2841
011	2697 100	1	44x68	2841
013	100 1681	16	44x135	1825
015		8	44x135	942
017	405 100	22	44x135	549
018	100 405	1	44x68	549
W1-1	016 014 012 009 008 004 799 5000	1	44x799	5000
W2-1	016 014 012 009 008 004 799 5000	1	44x799	5000
SH	HIT BLOCK-SCHLAGHÖLZER-MADRIERS D'ASSEMBLAGE	2	44x135	300
RB1	ROOFBEAMS-DACHBALKEN-SOLIVES DE PLAFOND 980 4712 200	4	70x140	5980
RB2	ROOFBEAMS-DACHBALKEN-SOLIVES DE PLAFOND 980 200	1	70x140	5980

Änderungen vorbehalten.











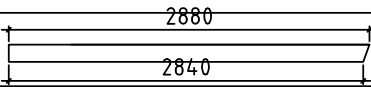



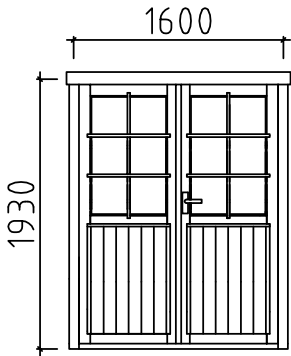

MONTAGEANLEITUNG

GARTENHAUS HAWAII



STÜCKLISTE

Pos	Specification-Bestimmung-Omschrijving	Pcs	Profile (mm)	L (mm)
R1	ROOFBOARD-DACHBRETTER-KATTOLAUTA  88mm or -oder-ou 114mm	138+1 106+1	18x88 18x114	2780
GB	GABLE BOARD-GIEBELBLENDE-PLANCHE DE RIVE 	4	18x120	2880
EB	EAVE BOARD-TRAUFBRETT-LATTES SOUS VOLIGES 	4	18x120	2990
ES	EAVE SLAT-TRAFENLEISTE- Baguettes pour fixer les lattes sous voliges 	4	30x40	2990
RFF	ROOF FELT FILLET-GIEBELLEISTE- Baguettes pour fixer les planches de rive 	4	18x70	2880
D	DIAMOND-RAUTE-ELEMENT DE DECORATION 	2	18x90	200
SS1	STORM SLAT-STURMLEISTE-STORMLIJST 	4	35x18	2200
	SCREWS-SCHRAUBEN-SCHROEF  (FOR-FÜR-VOOR STORM SLAT-STURMLEISTE-STORMLIJST)	12	ø6	50
	WASHER-SCHEIBE-SCHIJF  (FOR-FÜR-VOOR STORM SLAT-STURMLEISTE-STORMLIJST)	12	ø6	
	DOUBLEDOR-DOPELTÜR-DUBBELE DEUR (right-rechts-rechts) AST_ISO_PL P.	1	1600	1930
		6		
		1		
		1		
		1		
		1		
		2		

Änderungen vorbehalten.



MONTAGEANLEITUNG

GARTENHAUS HAWAII



STÜCKLISTE

Pos	Specification-Bestimmung-Omschrijving	Pcs	Profile (mm)	L (mm)
	DOUBLE WINDOW-DOPPELFENSTER-DUBBELE VENSTER AST_ISO_KP	2	1340	1050
		4		
		4		
		8		



MONTAGEANLEITUNG

GARTENHAUS HAWAII



HK-Lasur

Dekorative, lösemittelbasierte
Premium-Holzschutz-Lasur
für Holz im Freien

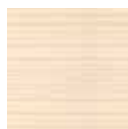

weiß*



farblos*



hemlock*



pinie/lärche



kiefer



eiche hell



eiche rustikal



mahagoni



teak



nussbaum



kastanie



palisander



ebenholz



salzgrün



tannengrün



Sonderfarbe

* Diese Farben nur für nicht direkt bewitterte Außenflächen wie Dachuntersichten usw. oder als Grundierung verwenden.

Biozide sicher verwenden. Vor Gebrauch stets Kennzeichnung und Produktinformationen lesen.

Holzschutzcreme

Lasur für den Schutz
und die Veredelung von
Holz im Außenbereich



eiche hell



pinie/lärche



kiefer



mahagoni



teak



nussbaum



palisander



weiß



silbergrau

Holzschutz- und Isoliergrund / UV-Schutz Lasur





MONTAGEANLEITUNG

GARTENHAUS HAWAII



Deckfarbe

Wasserbasierte, hochdeckende
Wetterschutzfarbe für Holz im
Außenbereich



weiß*



hellgrau*



dunkelgrau



königsblau



friesenblau



moosgrün



flaschengrün



nussbraun



tabakbraun



rotbraun



schwed. rot



maisgelb



goldgelb



schwarz



hellelfenbein*



skand. rot



anthr. grau



Sonderfarbe

* Bei diesen Farben ist zusätzlicher
Isoliergrund nötig. Bei dunklen
Deckfarben kann es aufgrund starker
Sonnenanziehung zur Trocknung des
Holzes und damit verbunden, zur
Rissbildung kommen.