

302 - Pop Up Booth Combo

Setup Instruction of curved & straight shape

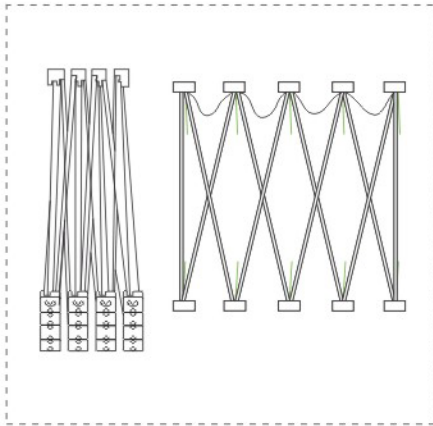

Stretch frame to size. Make sure webbing is not wrapped around black locking arms.

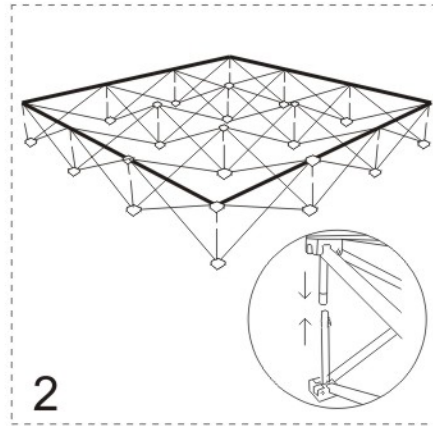

Align all green locking arms then nap all green locking arms into place.

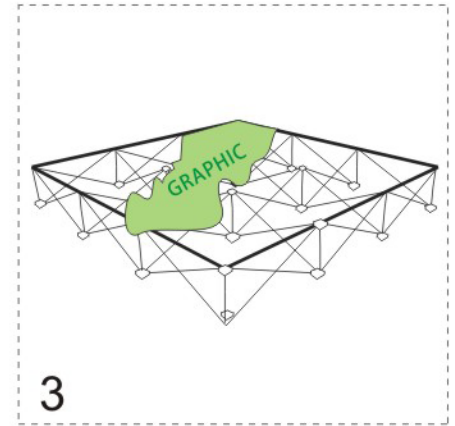

Graphic attaches to frame with velcro. Start in one corner and move on to the next.

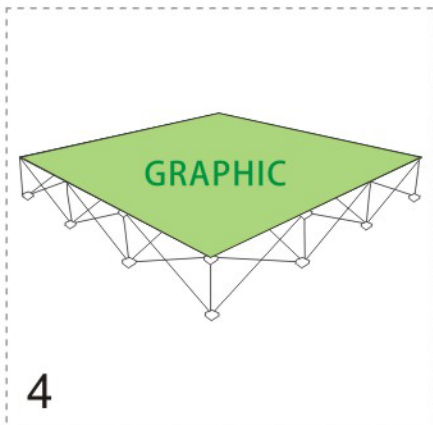

Graphic application is complete.

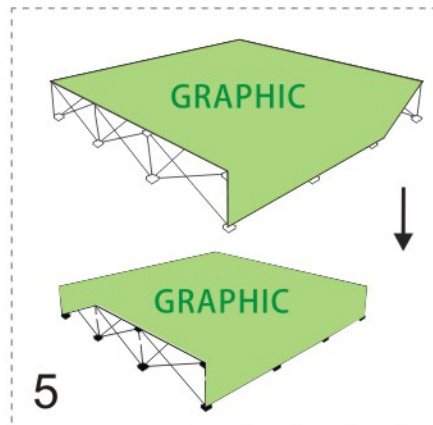

Pull end caps down to corner of frame and attach. Then attach other corner. Afterwards, repeat on opposite side.

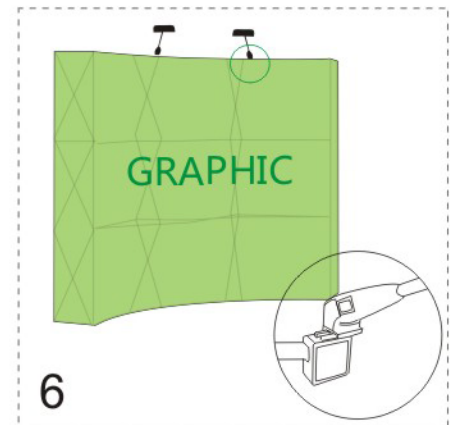

Attach the spot lights to the 2 mounts on top of the display stand.

PLEASE NOTE

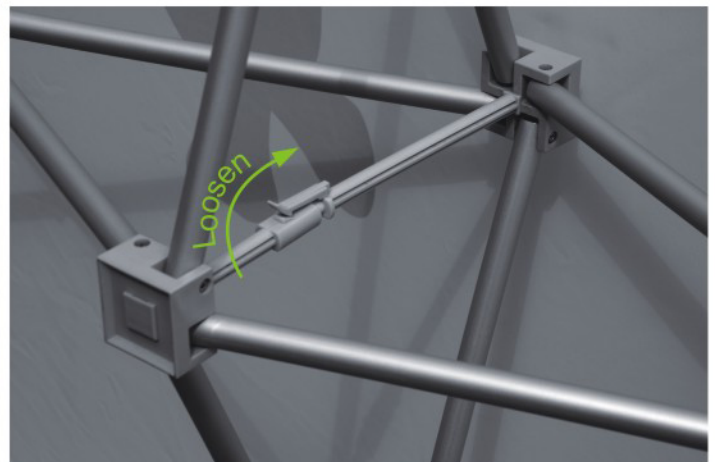
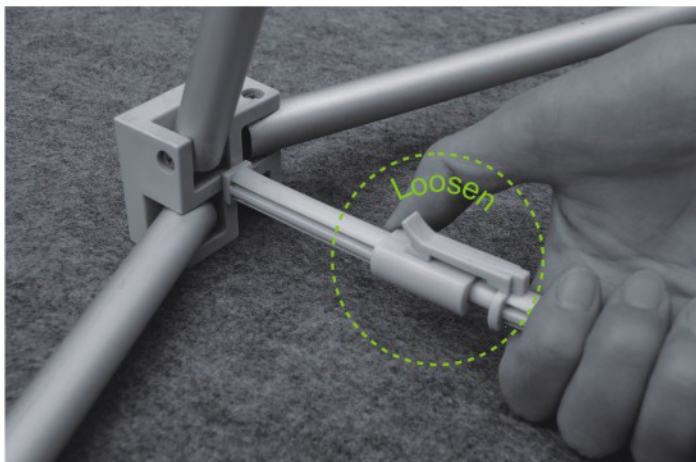

Make sure loosen all the locks Before fold up the Pop up display