

CAUTION! • CAUTION! • CAUTION! • CAUTION! • CAUTION!

WHOA!!! CAUTION NOT SO FAST

This product is made out of MDF / Supawood and is fragile of nature.

We recommend all pieces to be test fitted and if required contact pieces to be filled / sanded down for a better fit.

**PLEASE DO NOT FORCE FIT ANY PIECES AS IT
WILL BREAK!**

ENJOY BUILDING YOUR NEW MODEL.

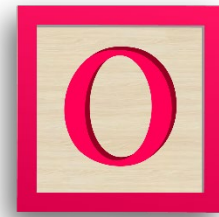

MILLENNIUM FALCON

www.wowwe.co.za

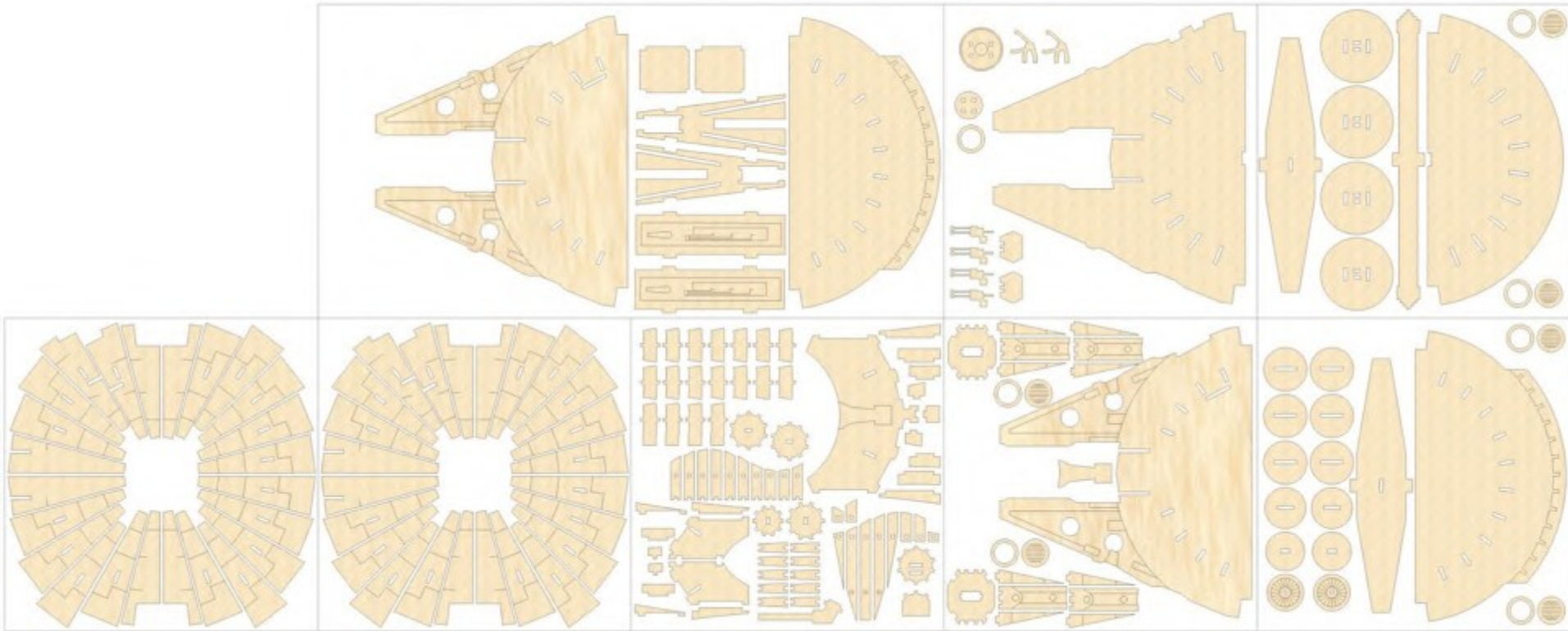

PARTS LIST

THESE PIECES ARE LONGER
THEY WILL HELP TO FIT THE
DETAILS UNDER THE SHIP

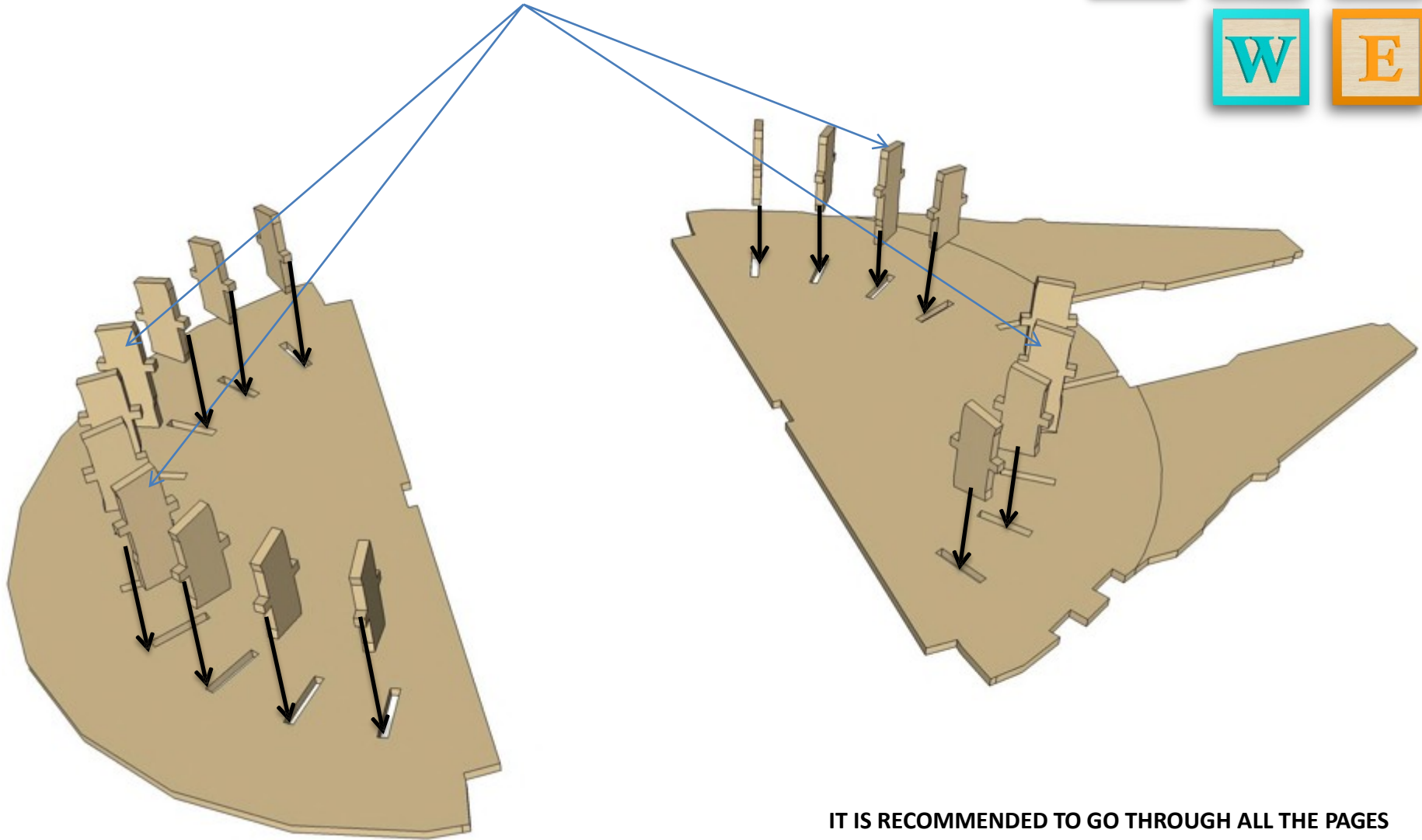

IT IS RECOMMENDED TO GO THROUGH ALL THE PAGES
AND SEE EACH STEP BEFORE STARTING THE ASSEMBLY

ASSEMBLY STEPS

www.wowwe.co.za

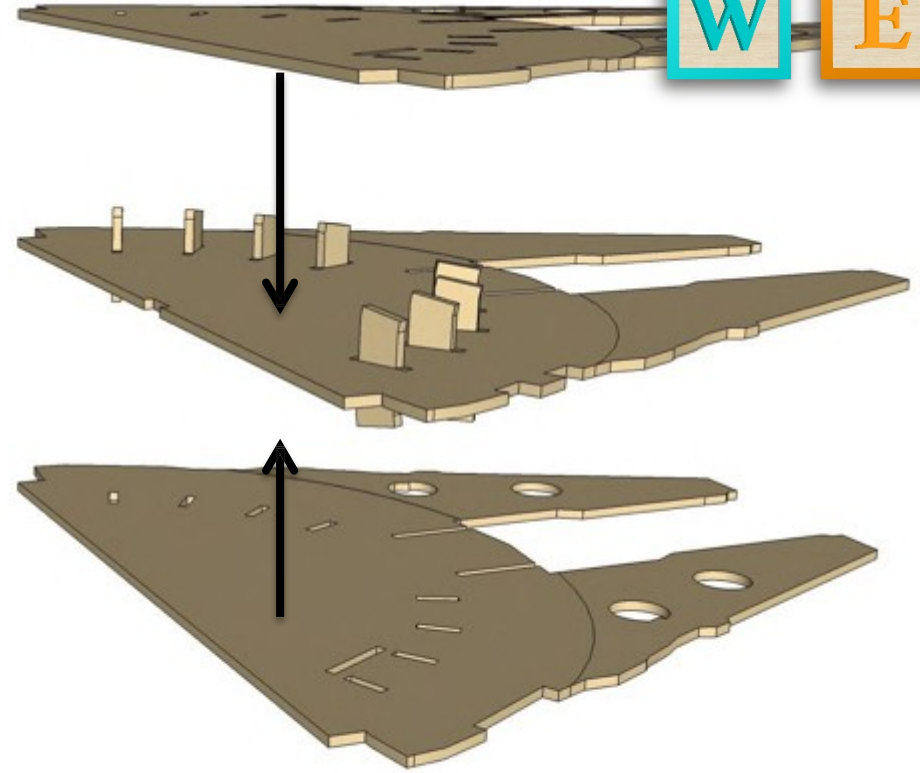
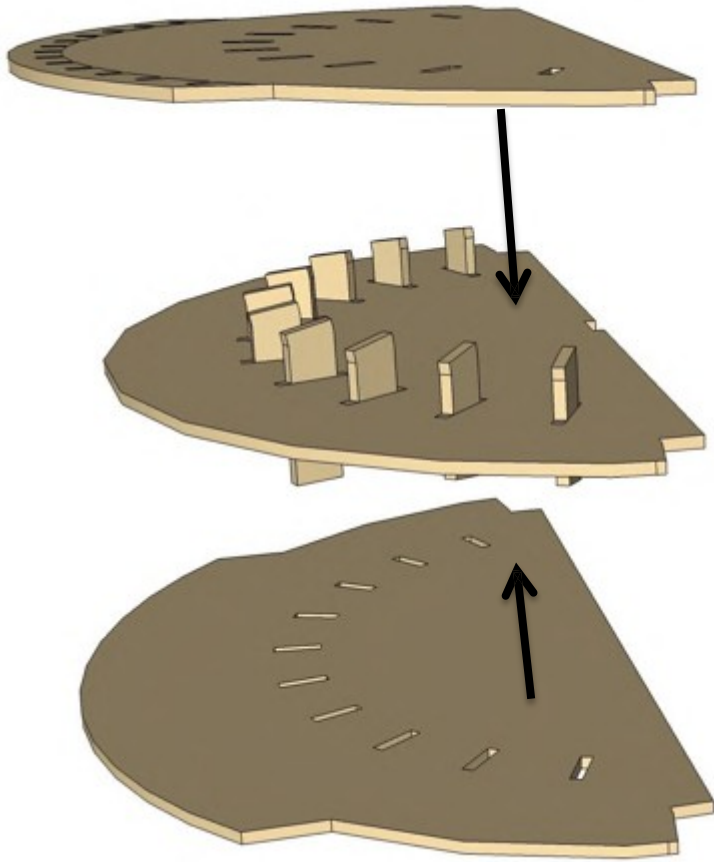

ASSEMBLY STEPS

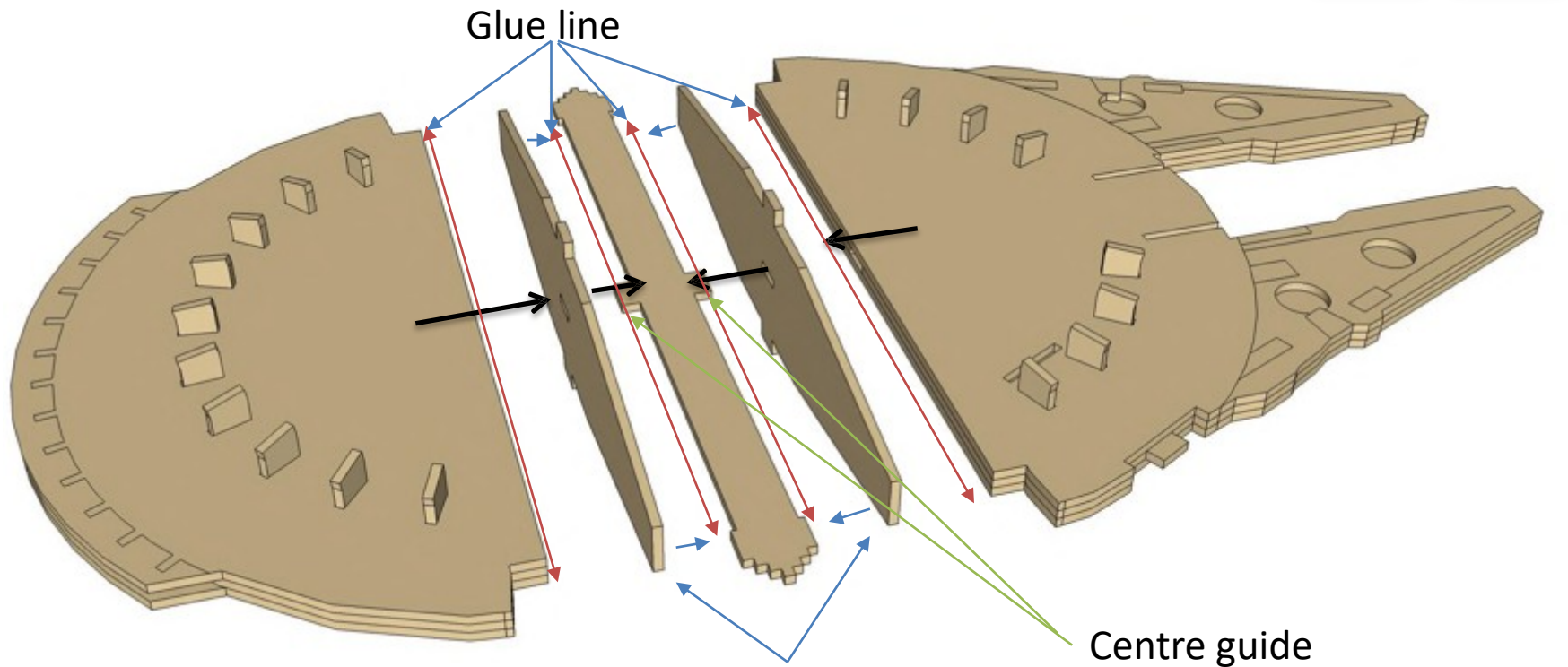

Glue sides first to centre piece.
Glue then the sides to the front and back disk

ASSEMBLY STEPS

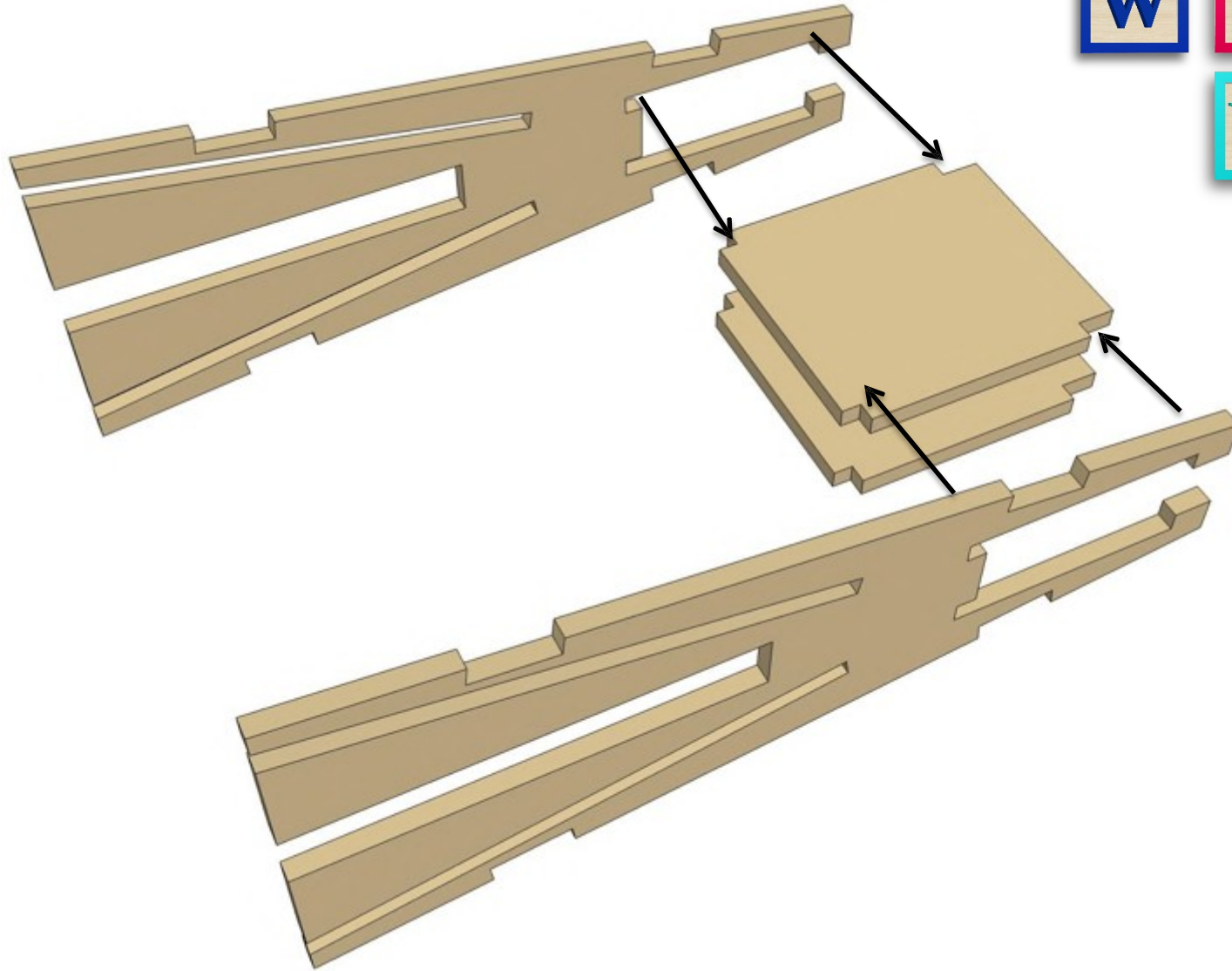

ASSEMBLY STEPS

www.wowwe.co.za

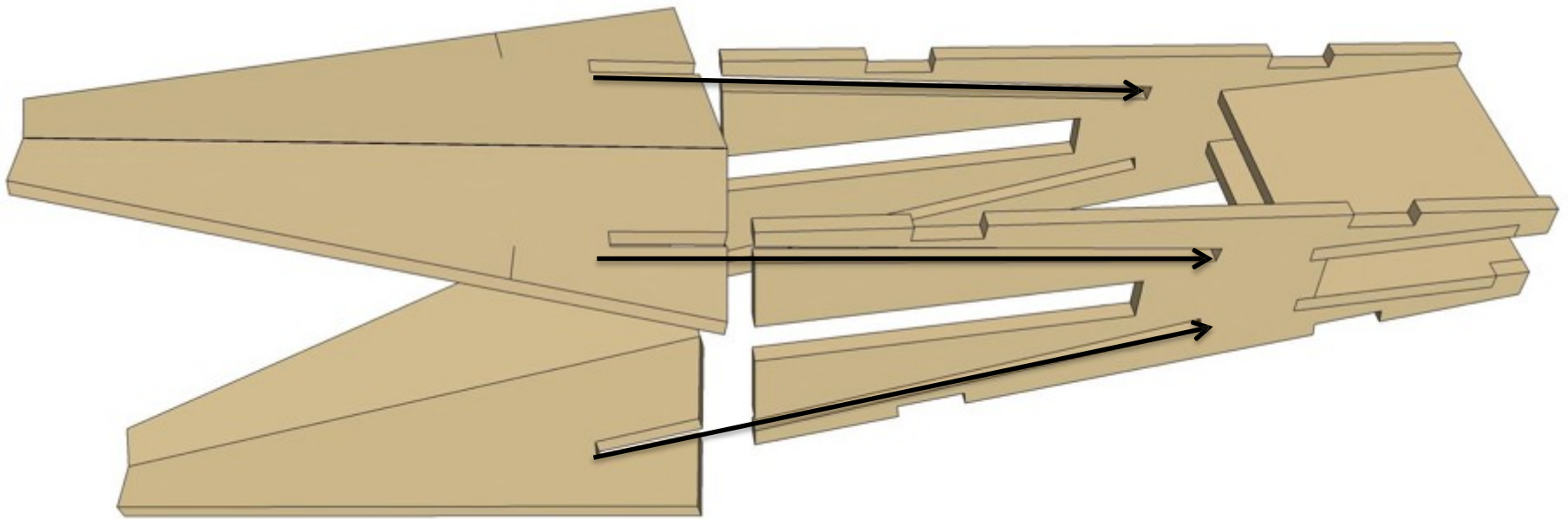

ASSEMBLY STEPS

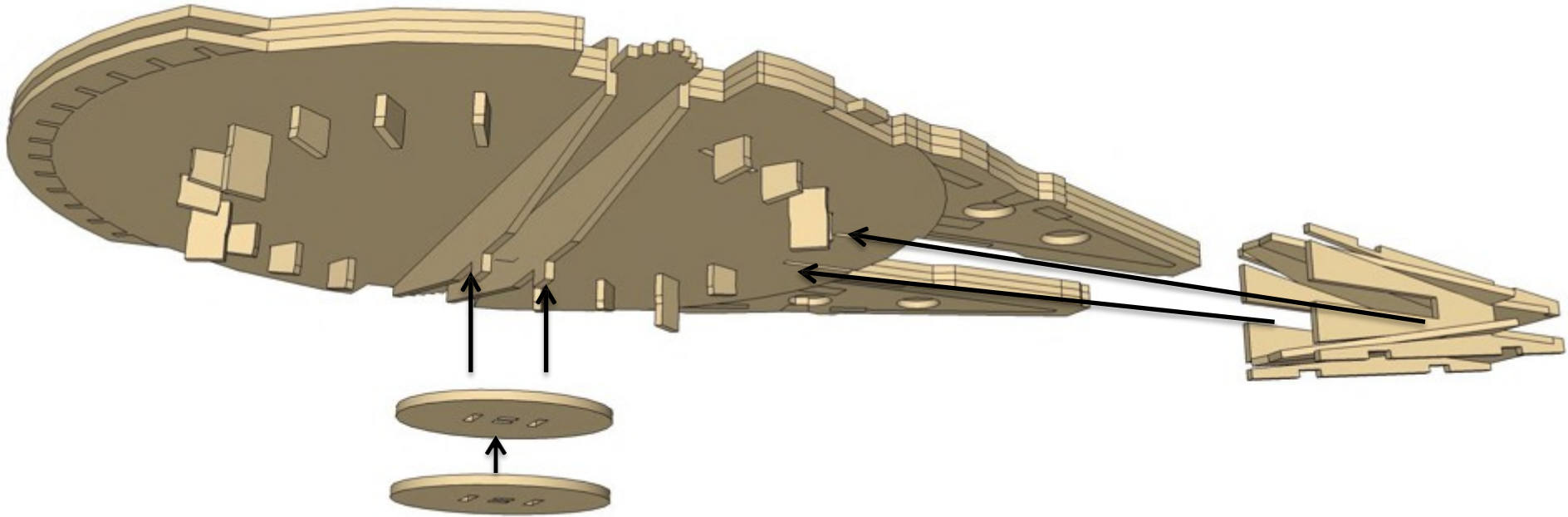

ASSEMBLY STEPS

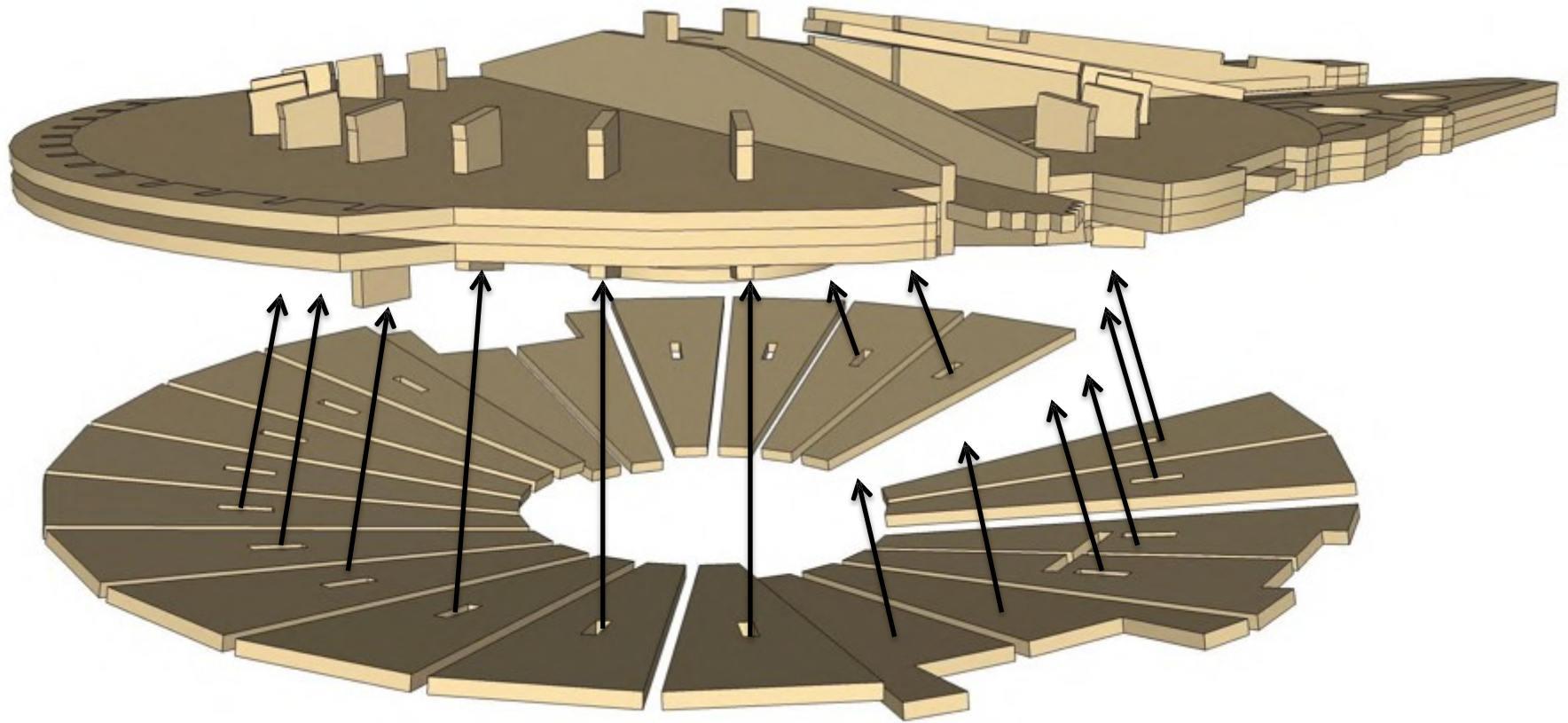

ASSEMBLY STEPS

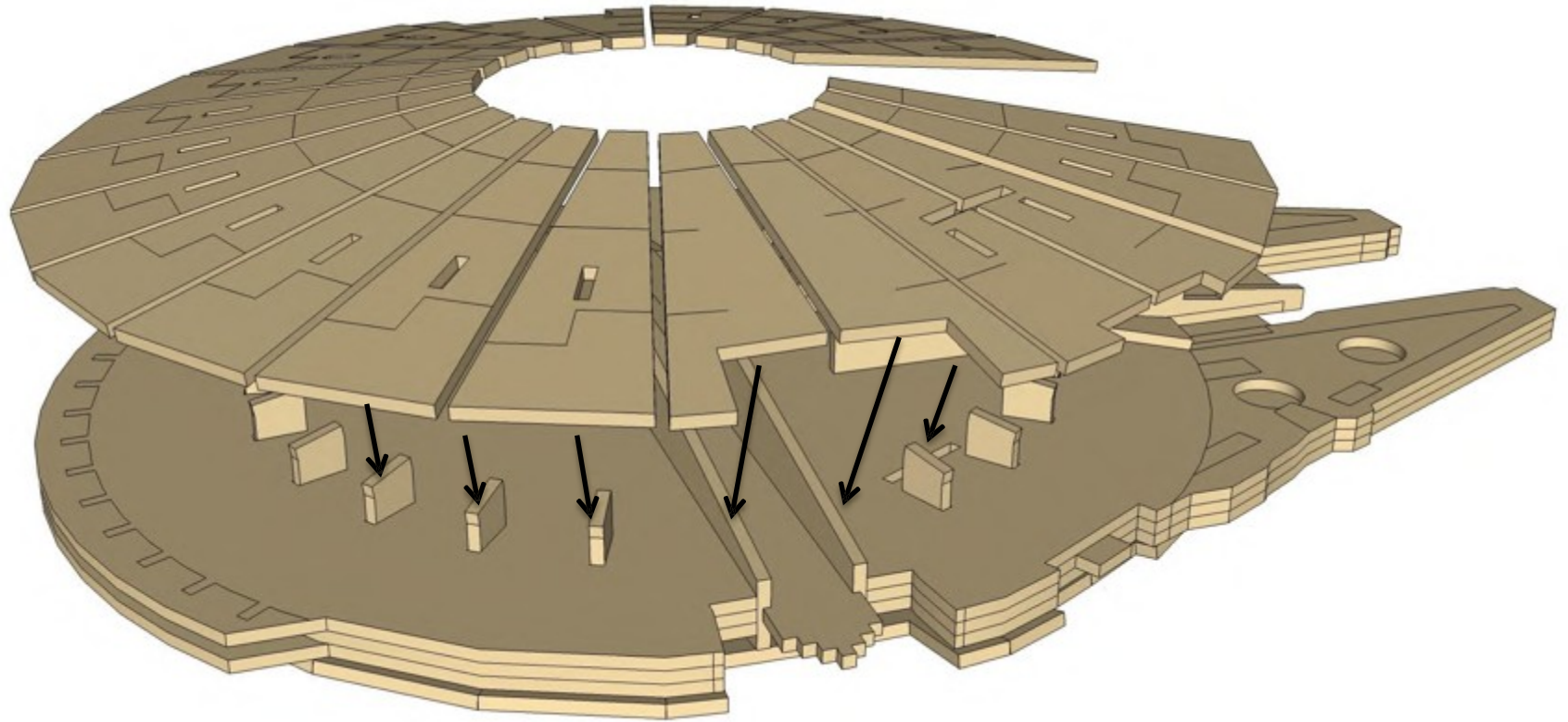

ASSEMBLY STEPS

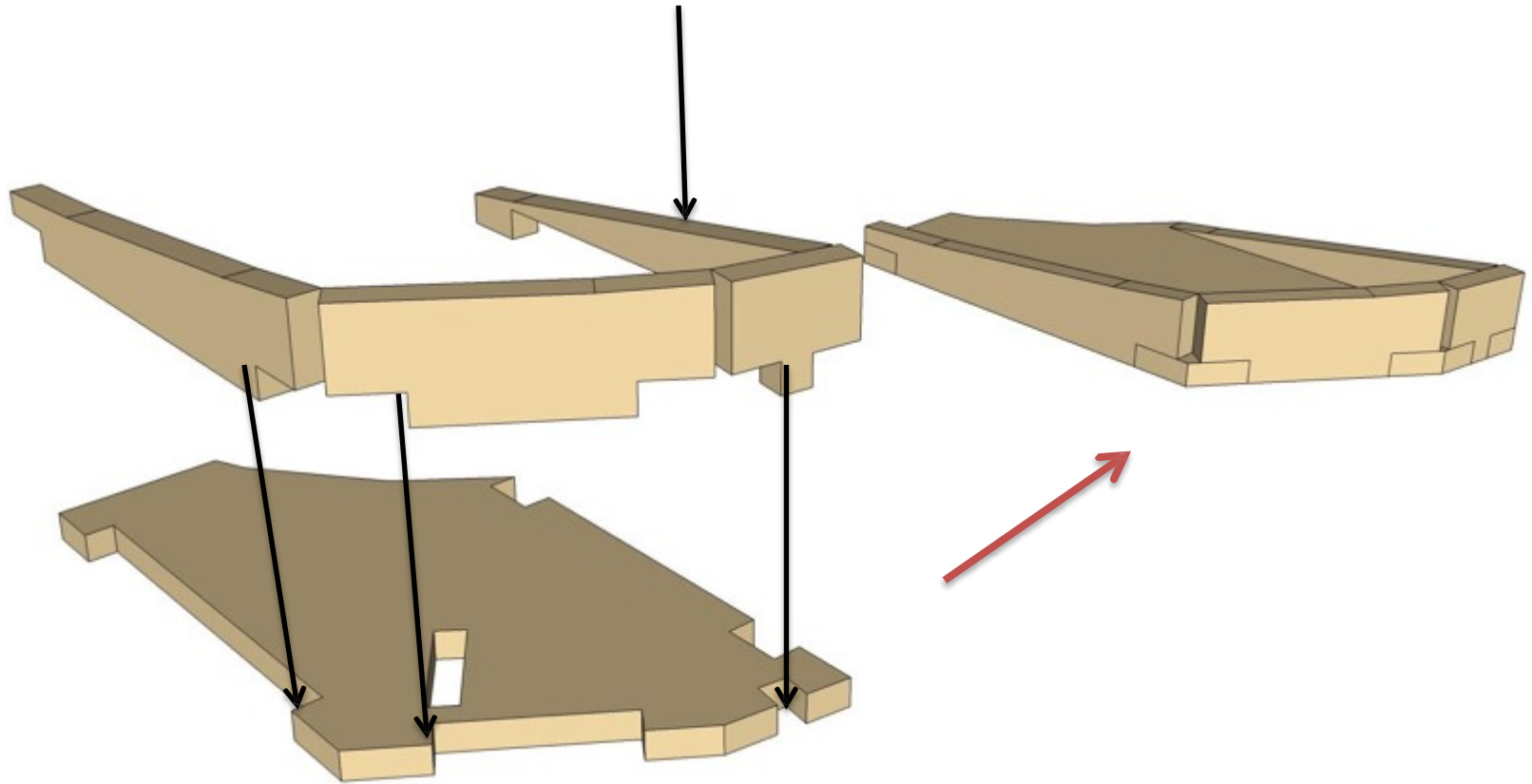

ASSEMBLY STEPS

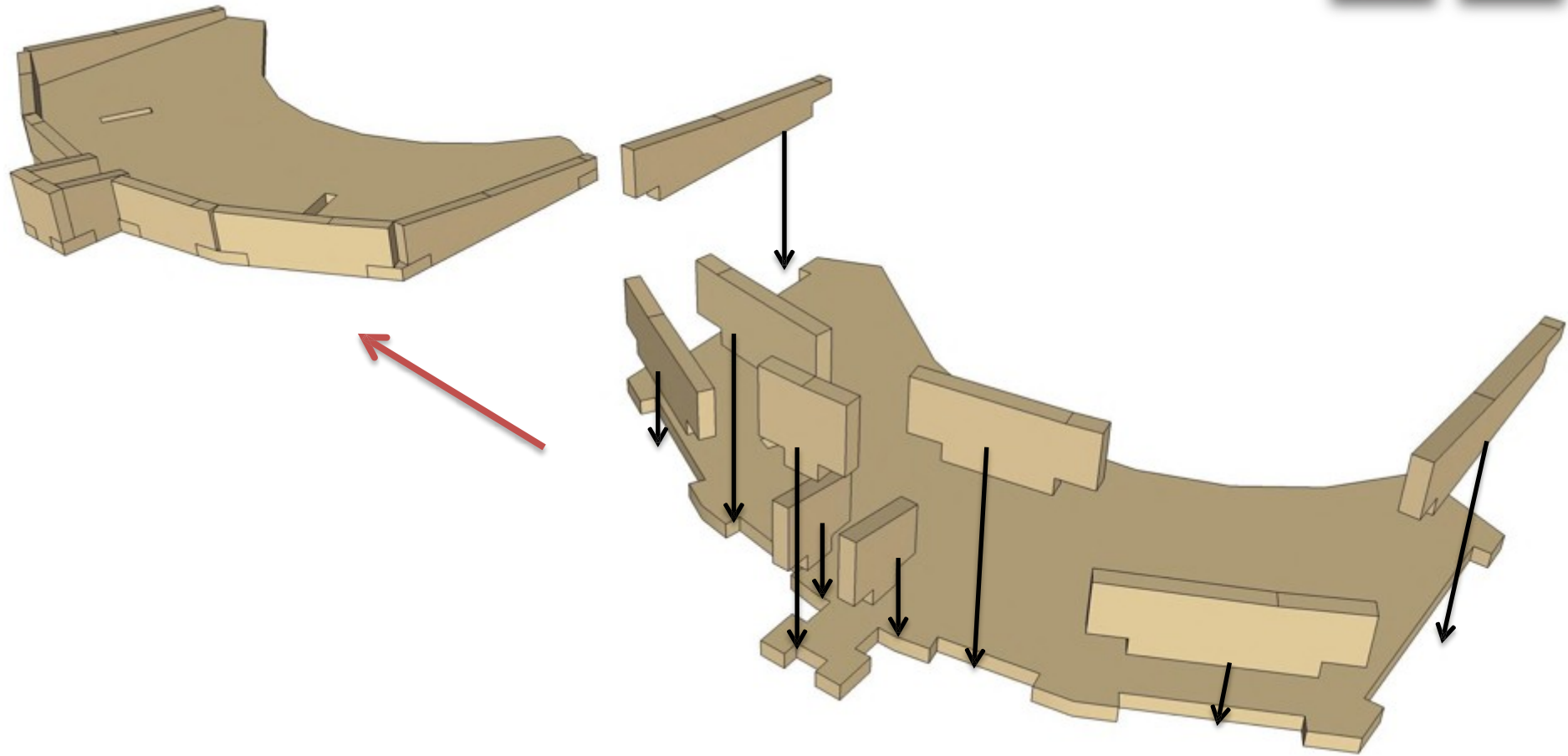

ASSEMBLY STEPS

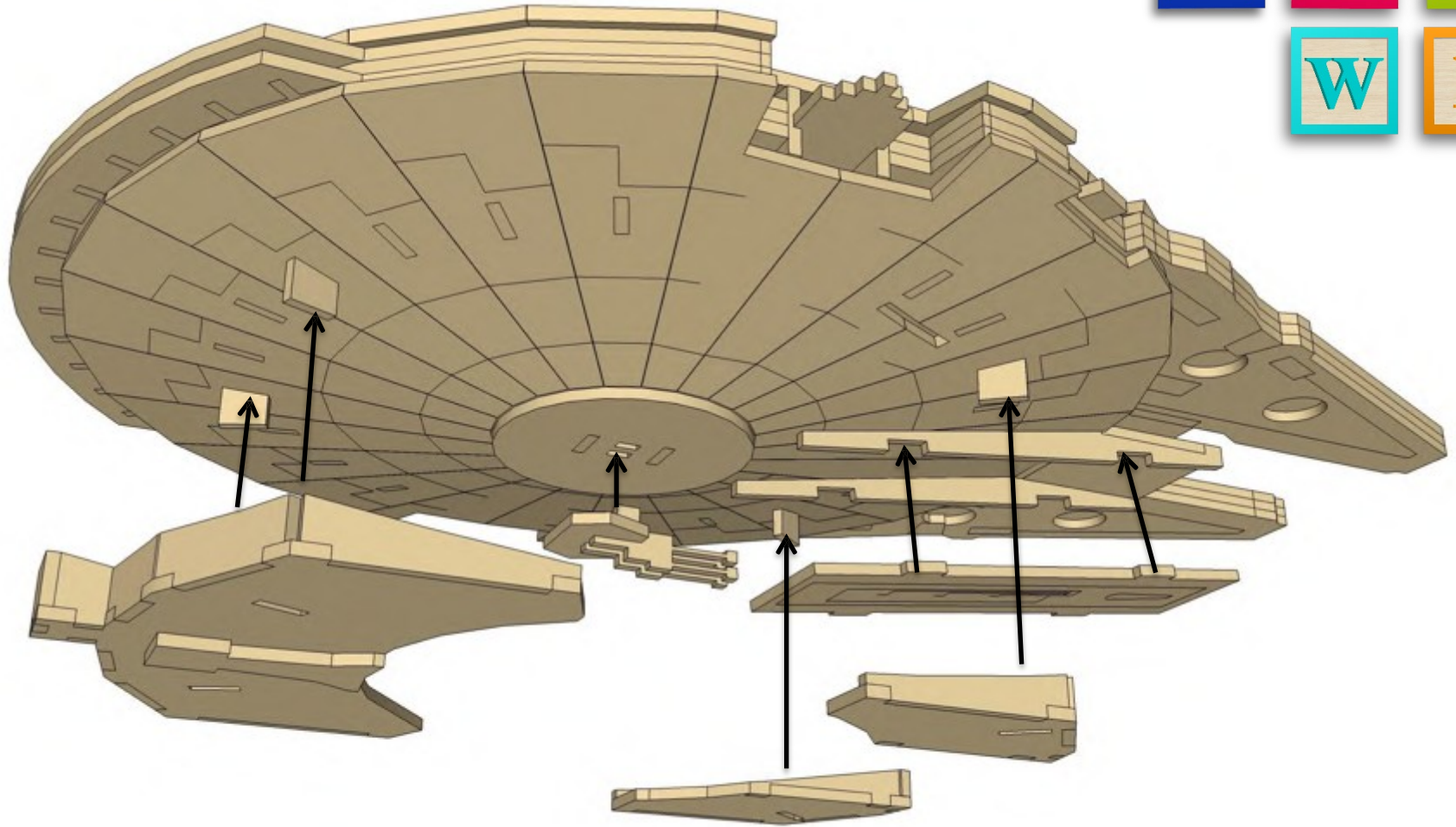

ASSEMBLY STEPS

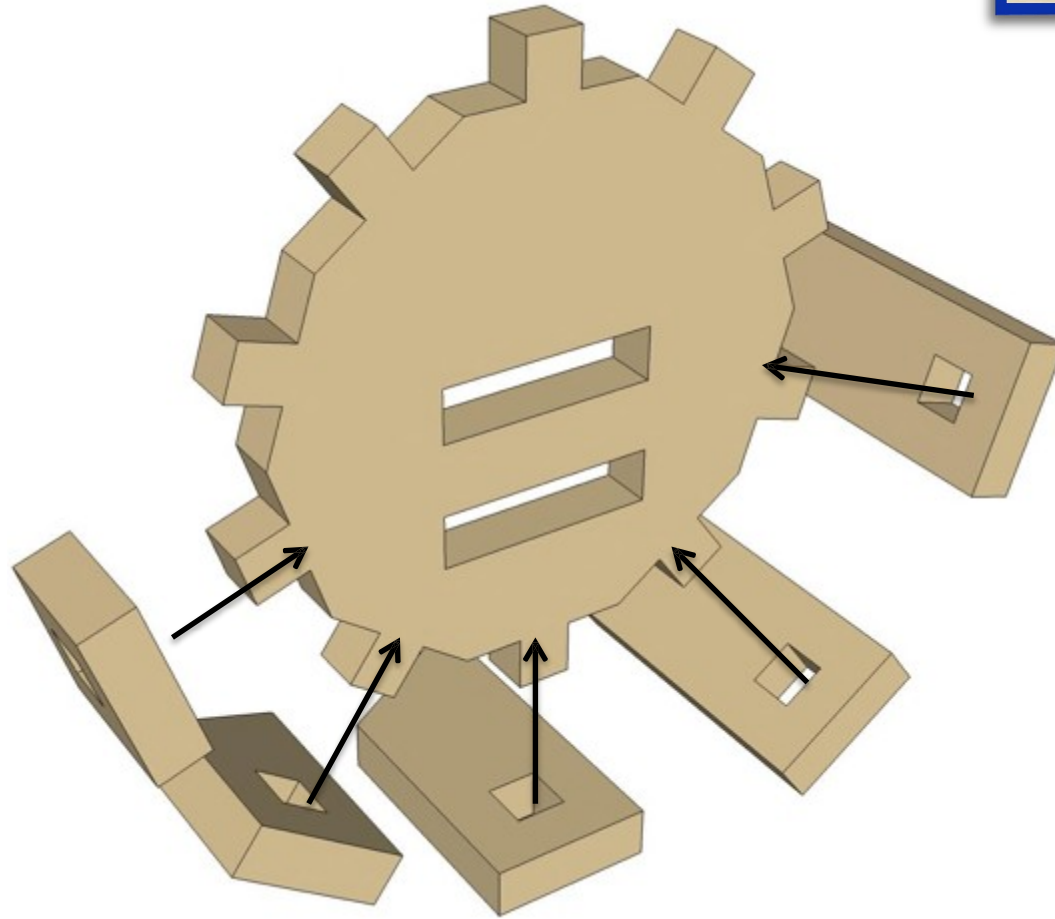

ASSEMBLY STEPS

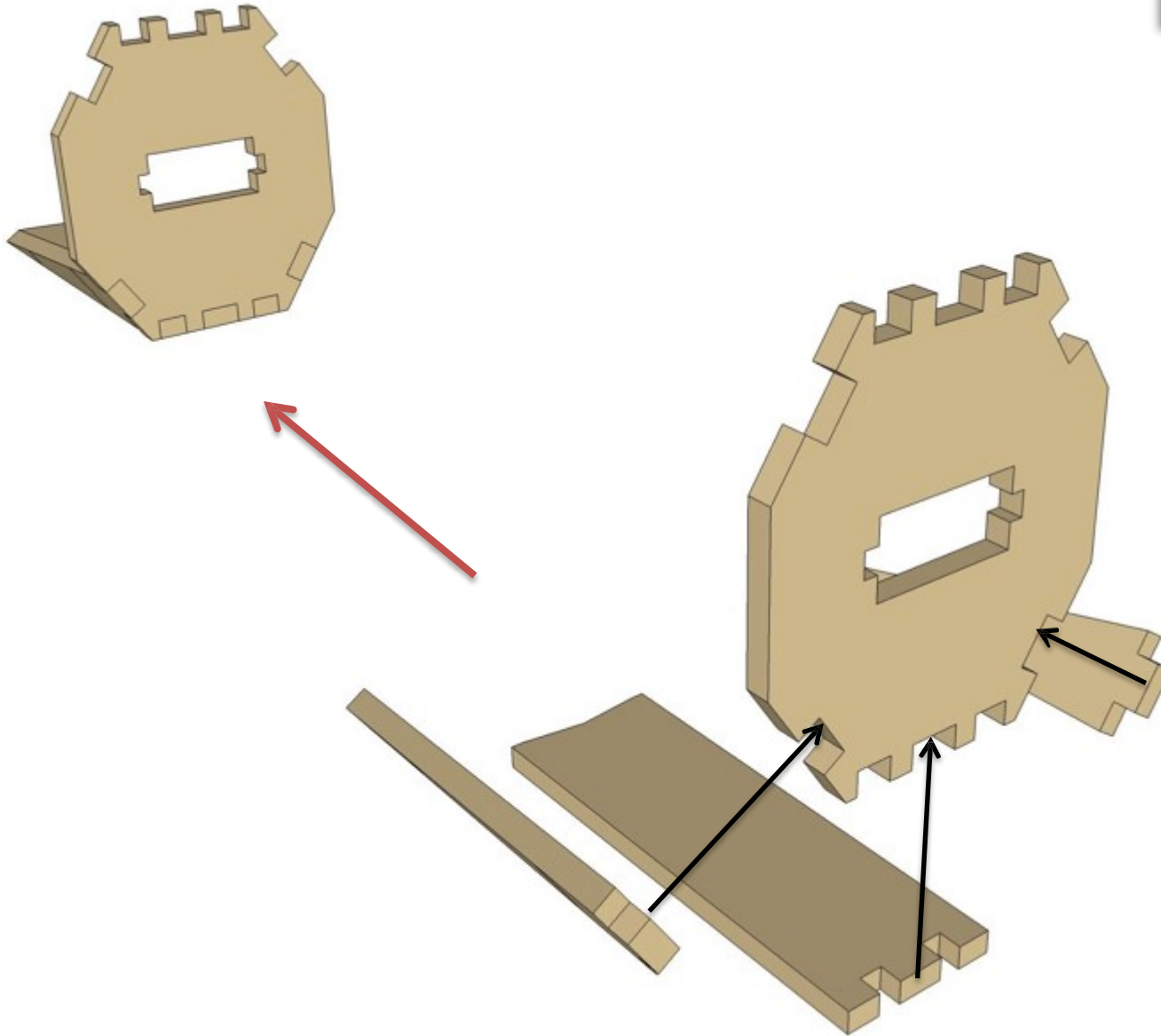

ASSEMBLY STEPS

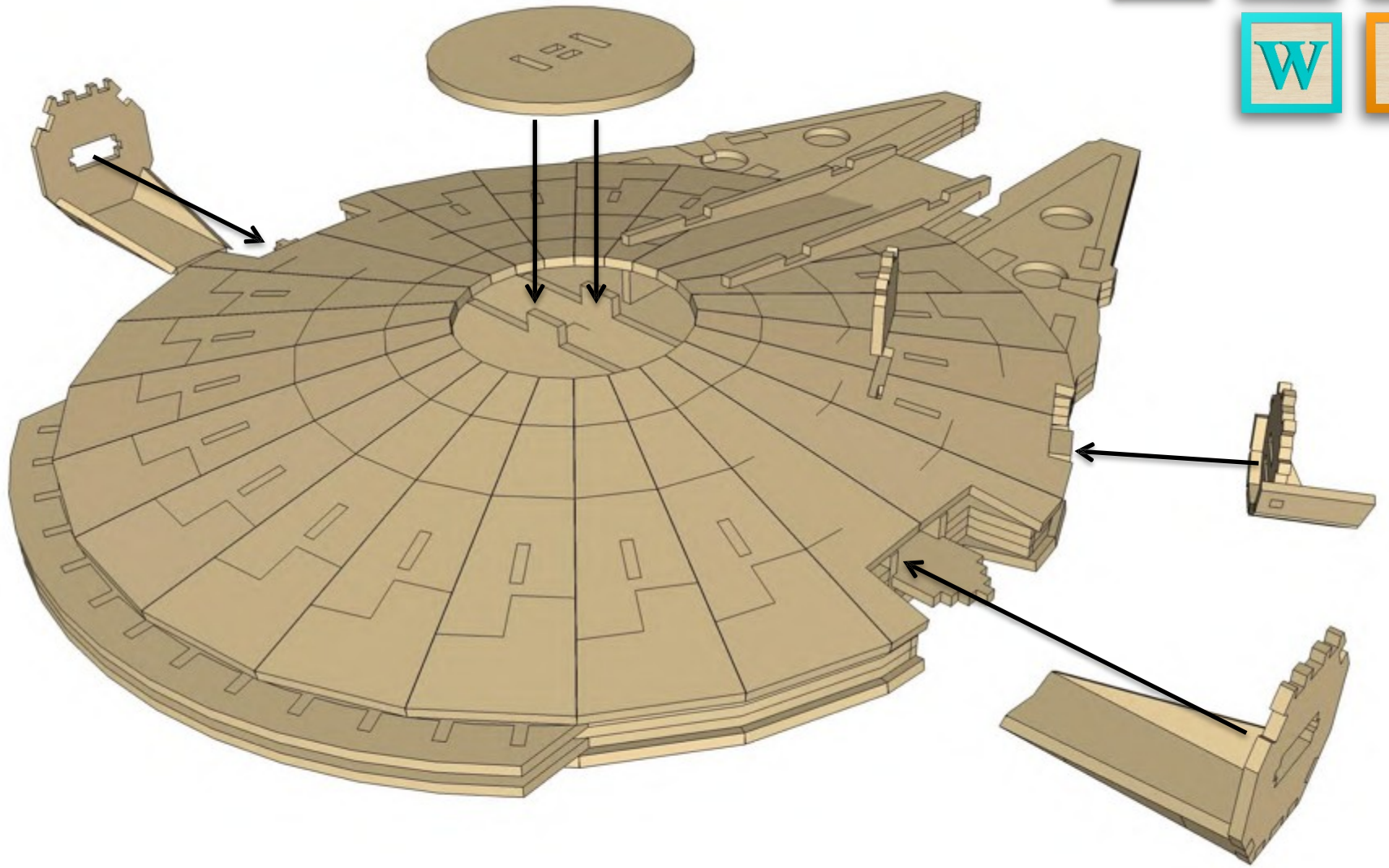

ASSEMBLY STEPS

www.wowwe.co.za

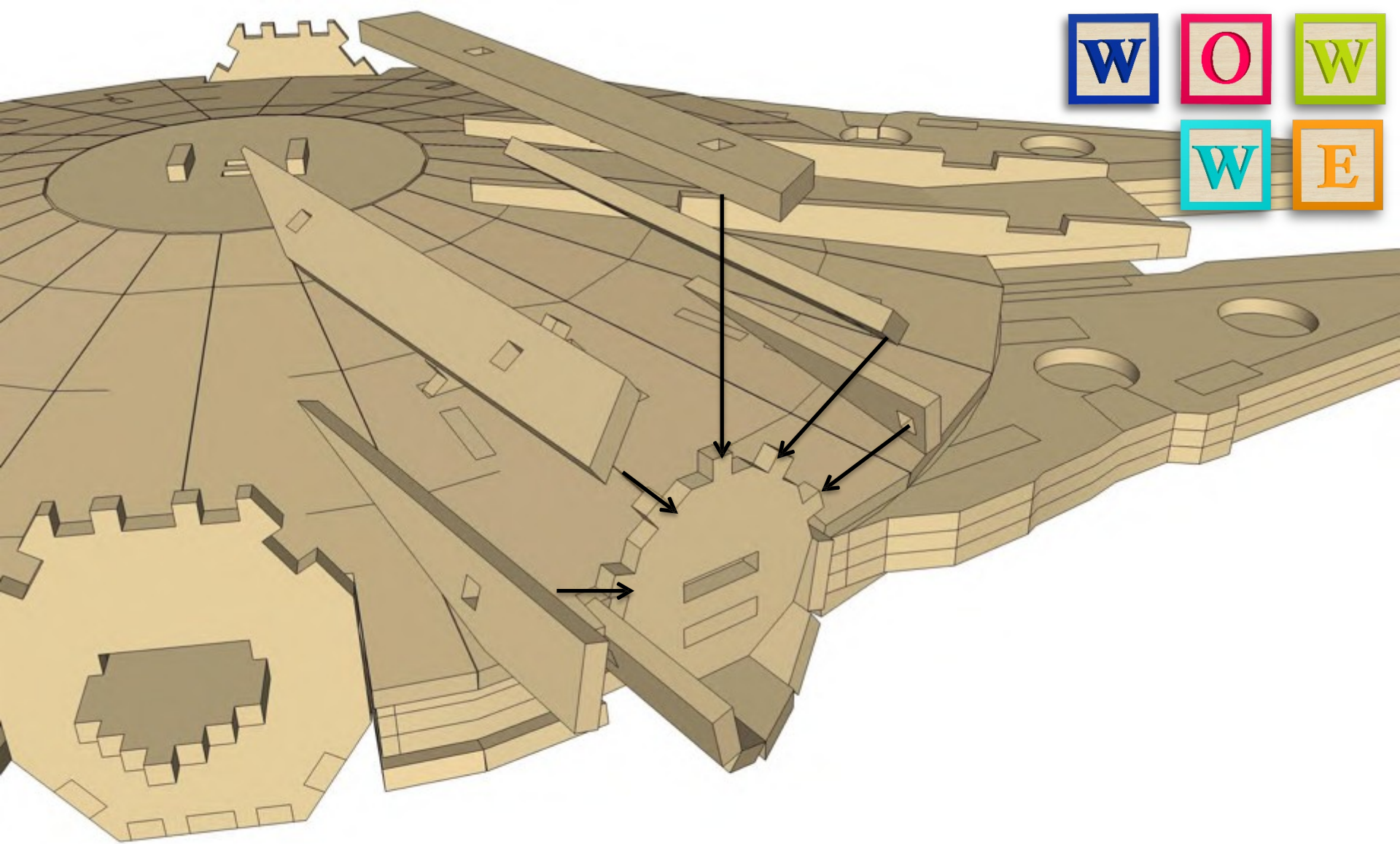

ASSEMBLY STEPS

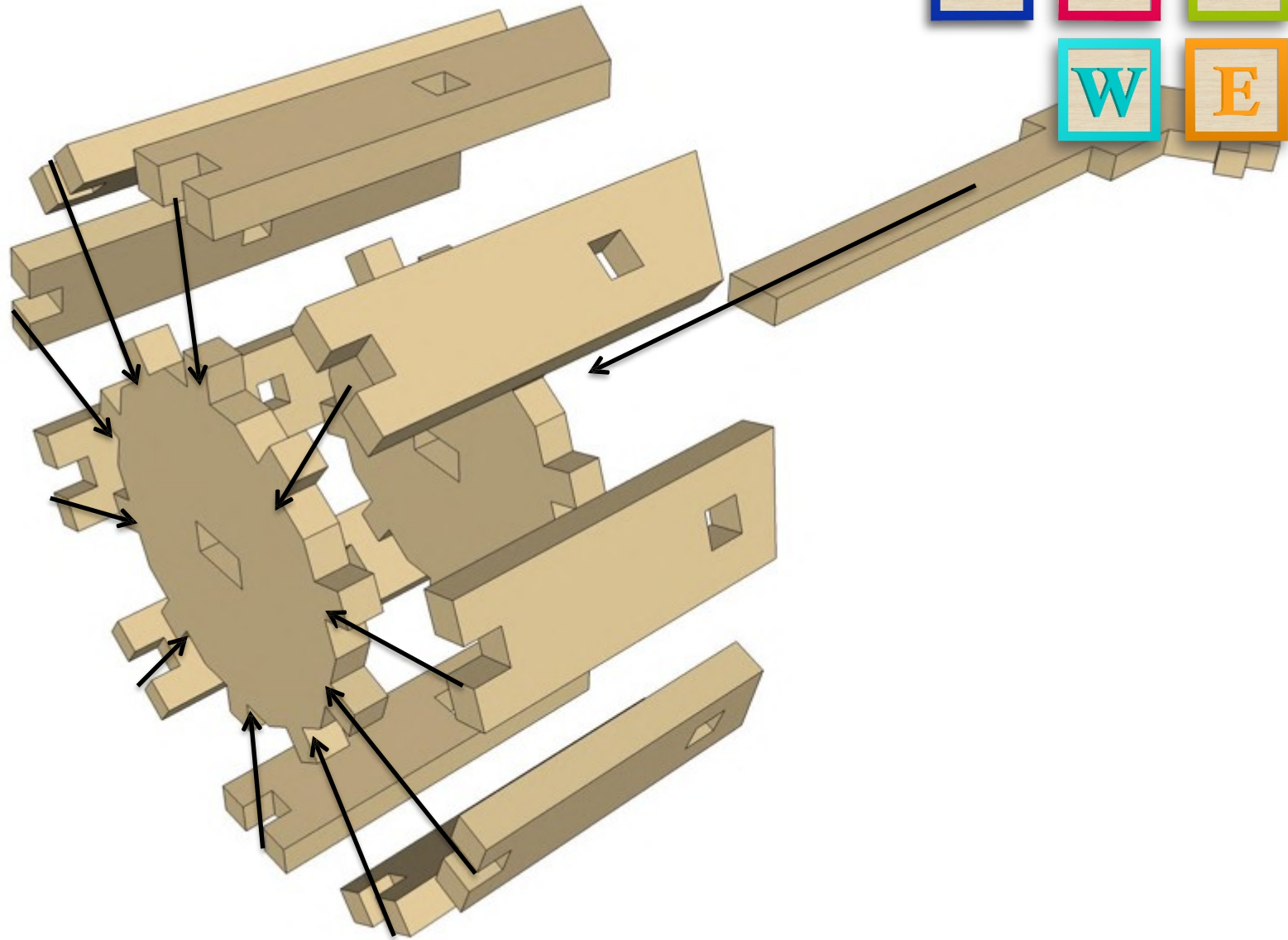

ASSEMBLY STEPS

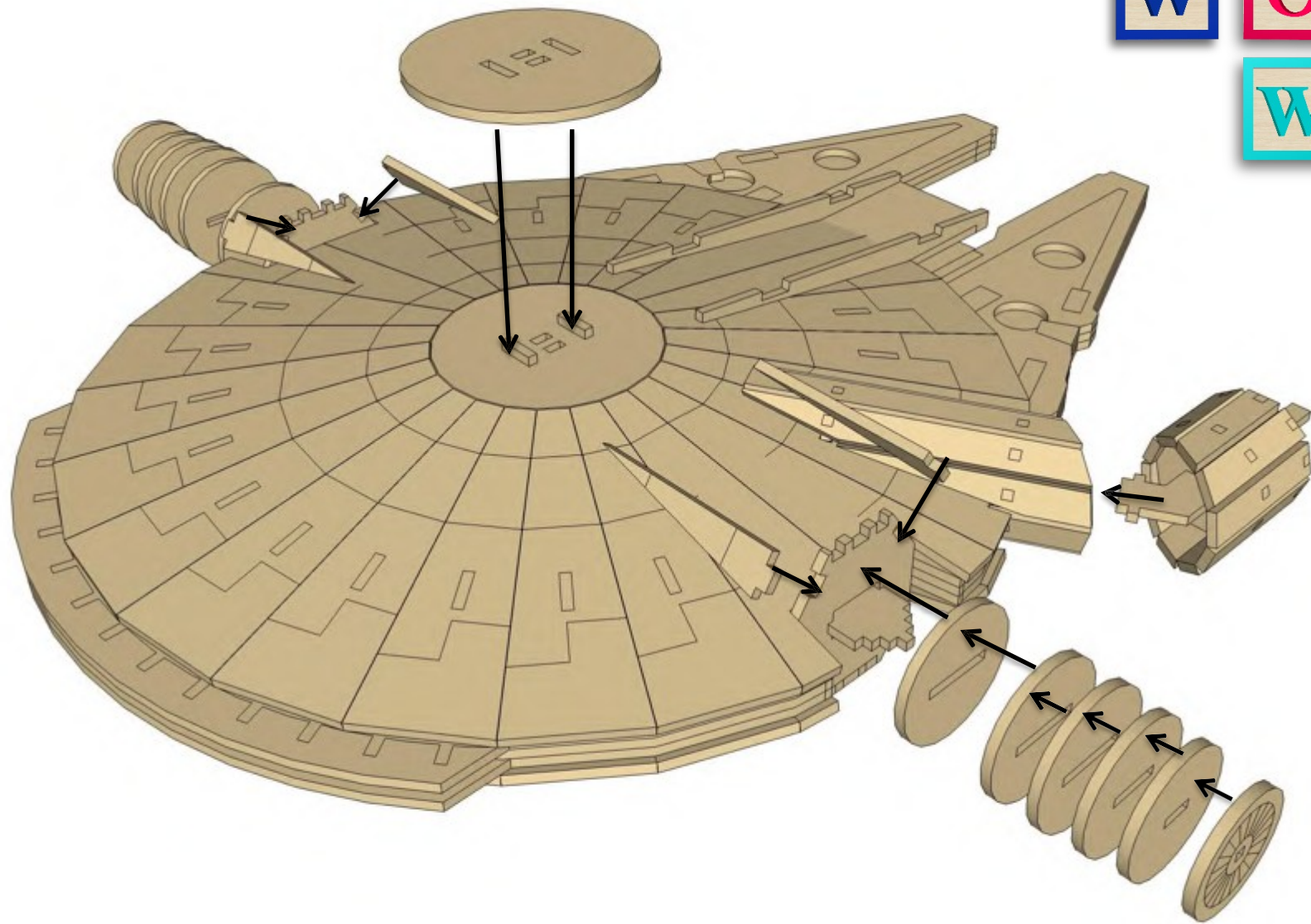

ASSEMBLY STEPS

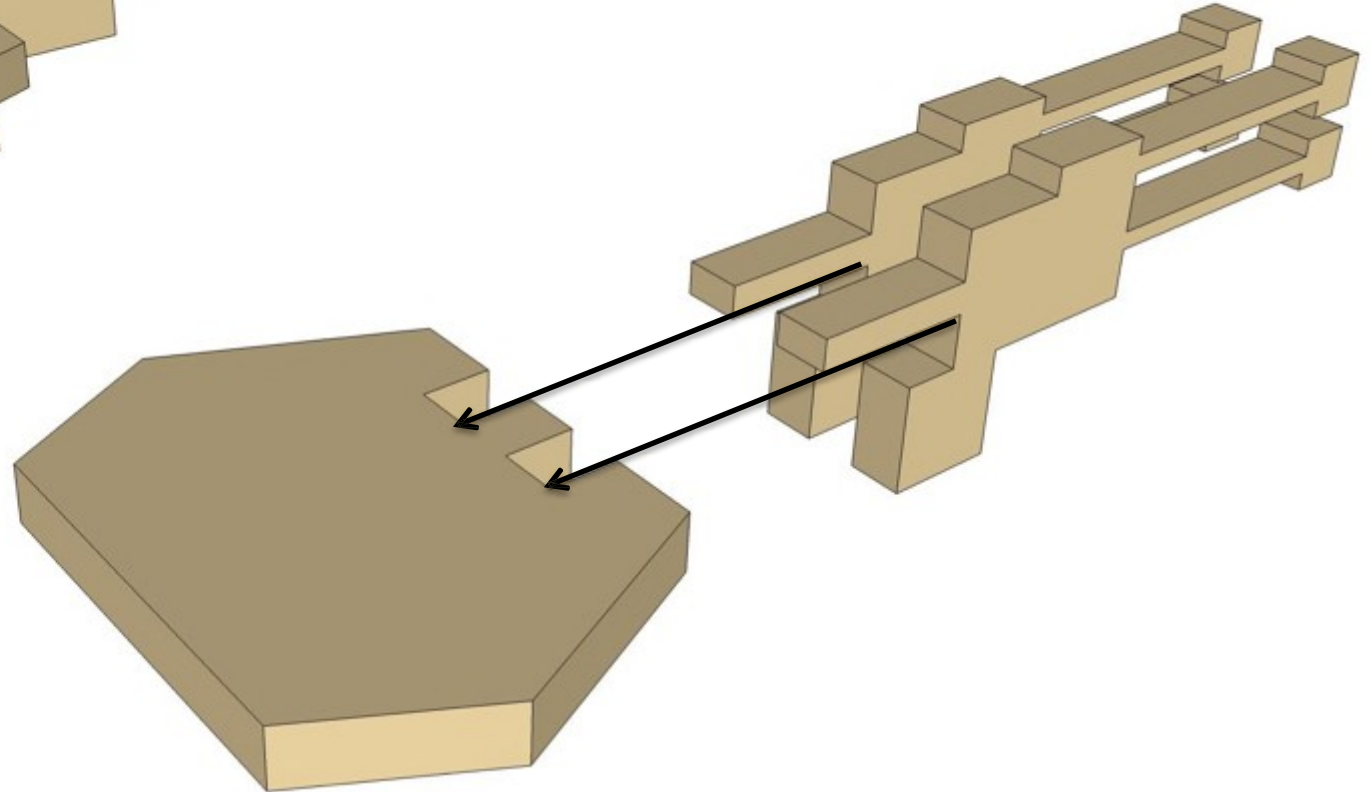
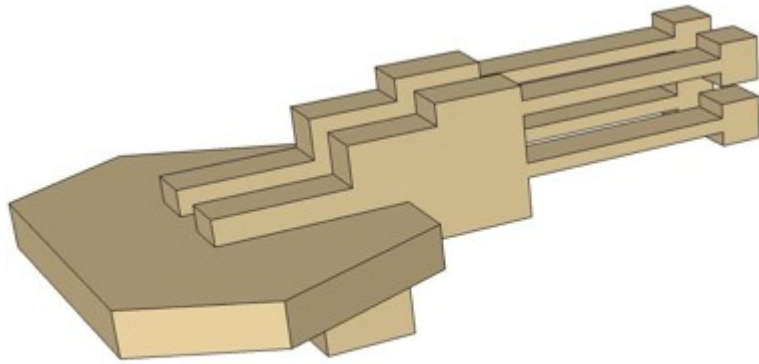

ASSEMBLY STEPS

www.wowwe.co.za

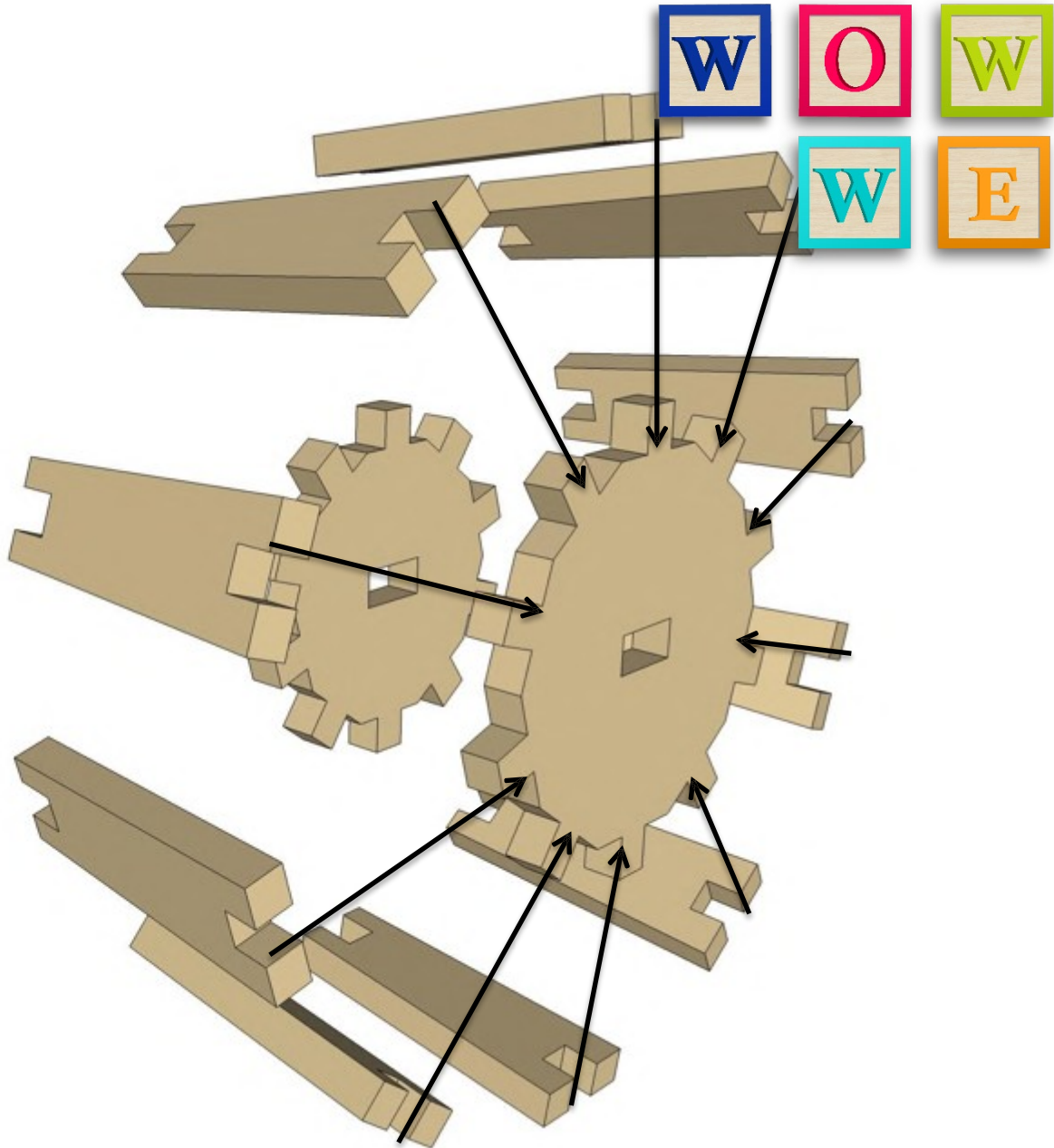
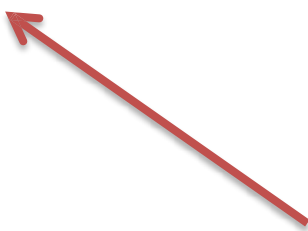
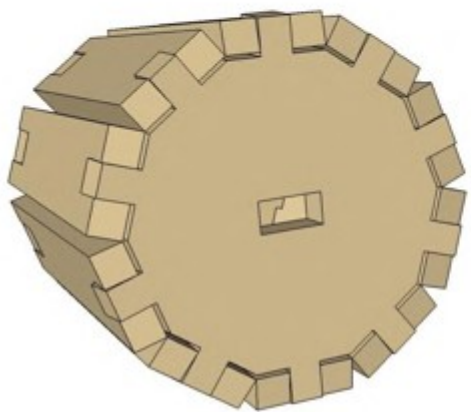

ASSEMBLY STEPS

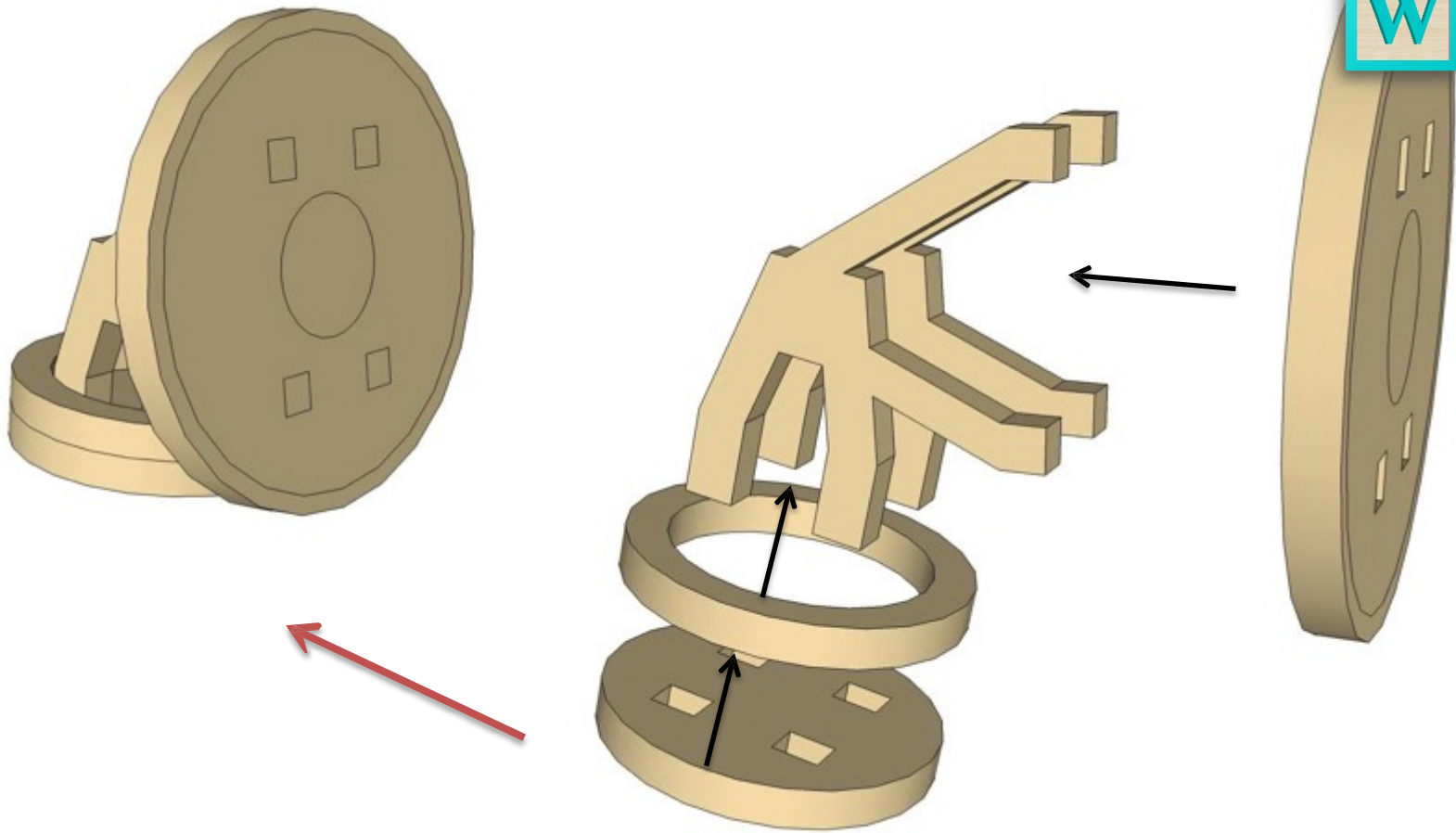

ASSEMBLY STEPS

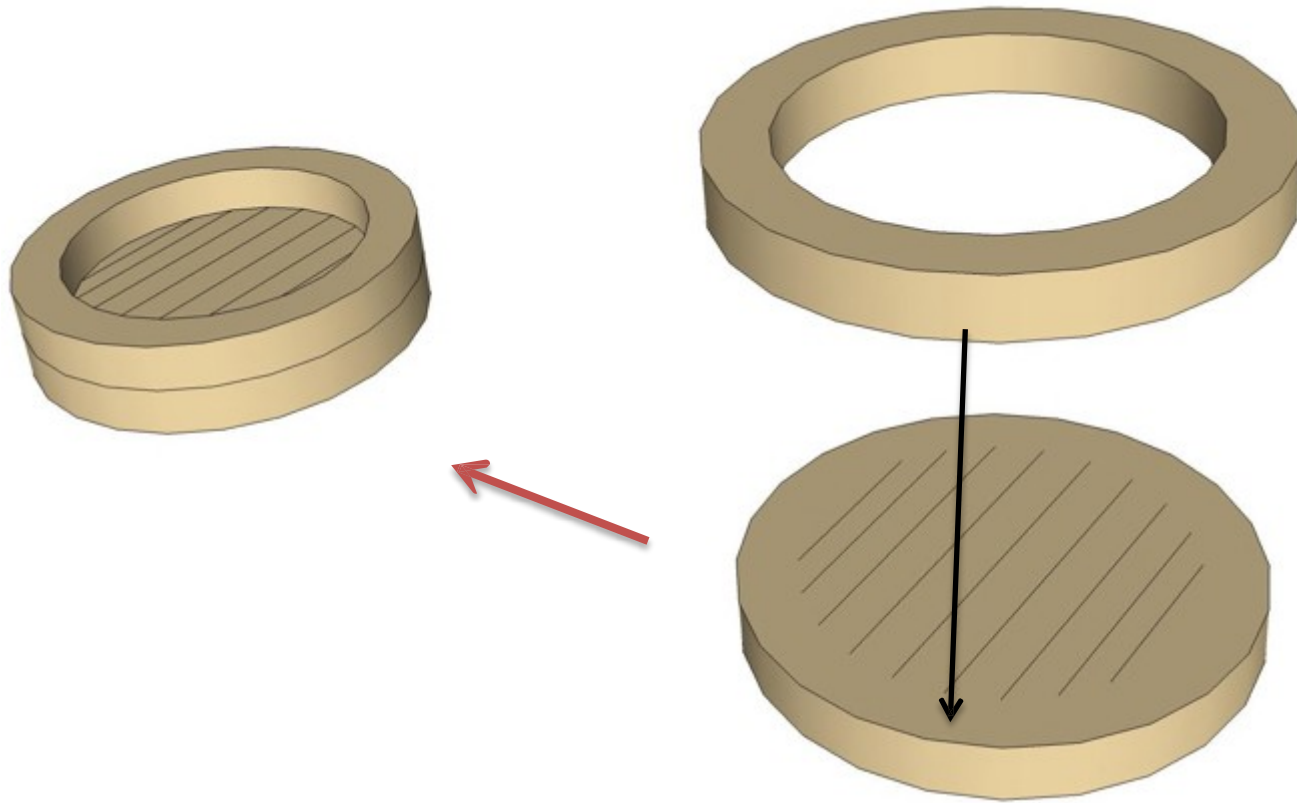

ASSEMBLY STEPS

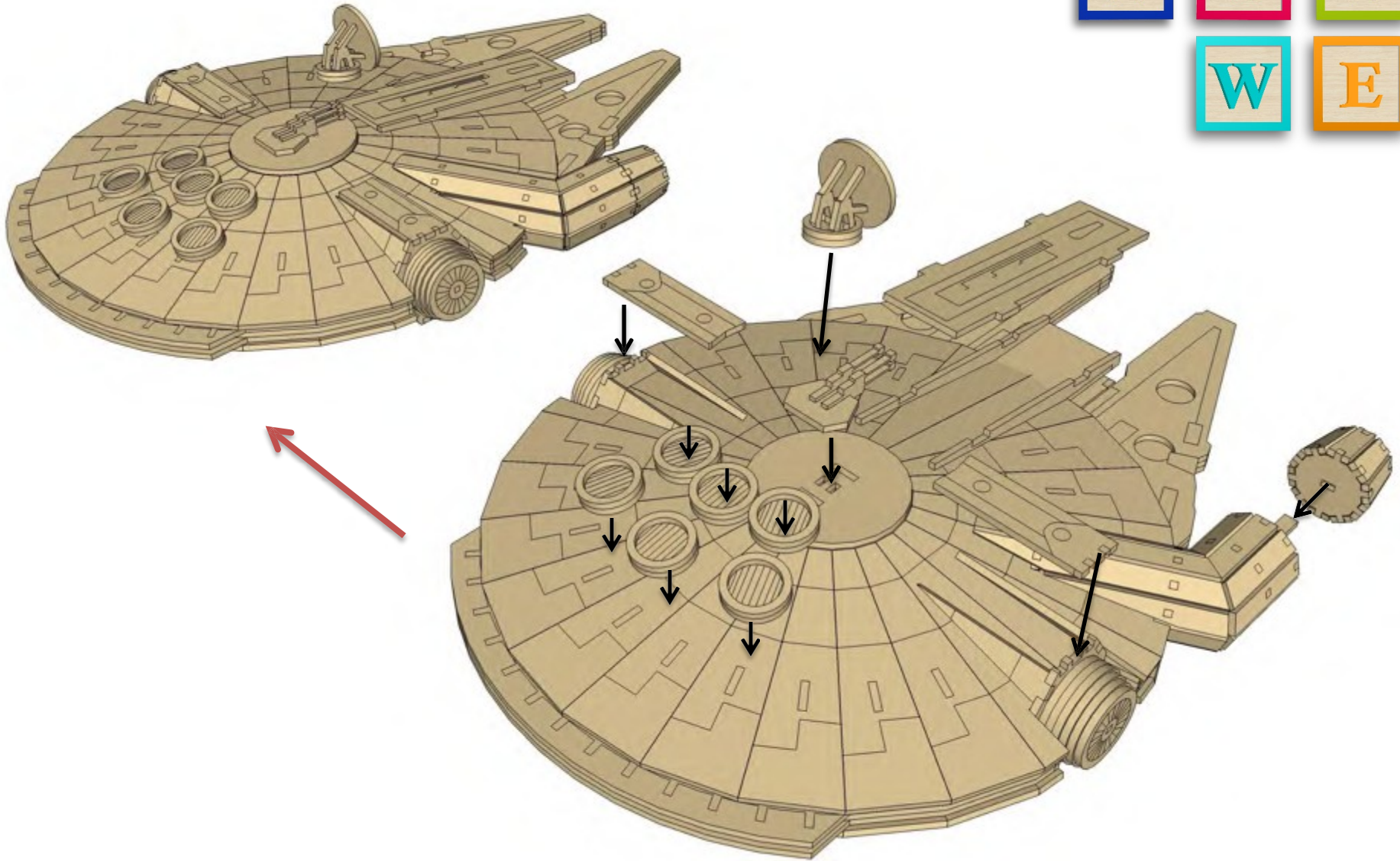

ASSEMBLY STEPS

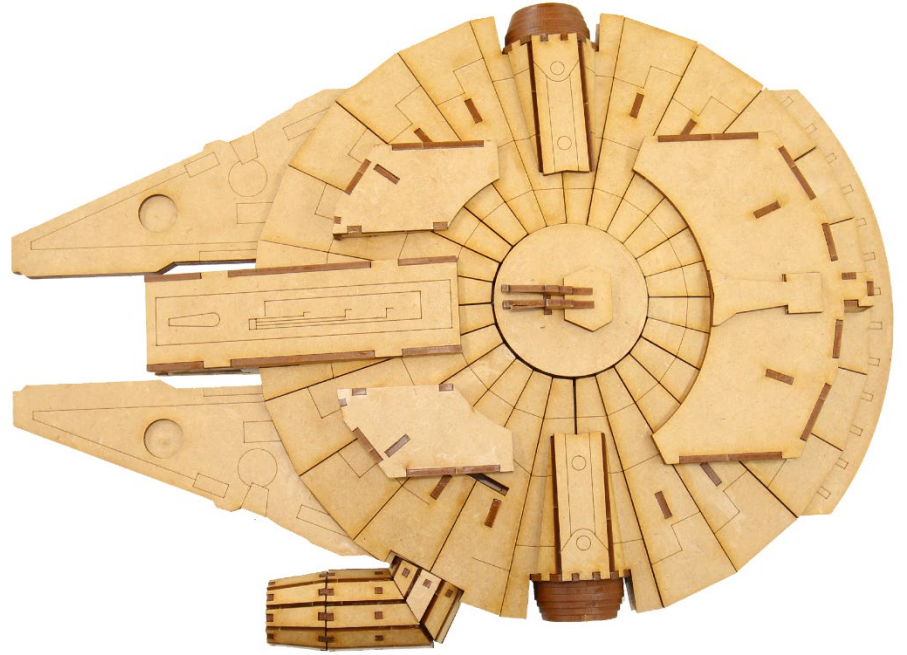
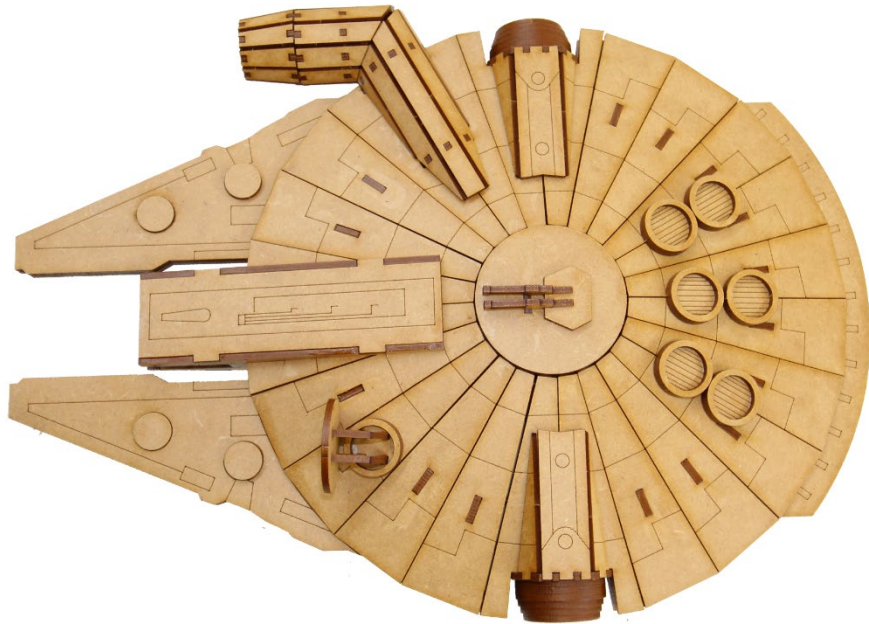

COMPLETED

www.wowwe.co.za