



# ZOHO™ 6th Gen



The ZOHO 6th Gen Area Light is included amongst Beyond LED Technology's best-selling products. The ZOHO 6th Gen Area Light offers high efficacy, with up to 160 lumens per watt for maximum power savings and rebates from power companies. These Area Lights have a new heat sink design that ensures a longer lifespan for the products. These products are a perfect solution primarily for outdoor applications such as lighting parking areas, loading docks and other general lighting applications.

## Product Features

- Up to 160 lumens per watt
- Wattage Adjustable
- CCT Adjustable 4000K / 5000K / 5700K
- Optional Screw-in photocell
- 0-10 Dimmable
- Built-in 10KV Surge protector
- Standard Universal Brackets
- Heat-resistant polycarbonate optical lens
- Die-Cast Aluminum Housing
- Input Voltage 120-277Vac/277-480Vac
- UL & DLC Listed
- 5 Year Warranty

# ZOHO™

## 6th Gen



SKU #	Model #	Wattage Adjustable	Lumens	CCT Adjustable	Housing	Input Voltage	Dimming	Certifications
156752	BLT-S-G12-150WBT3SA2-BR10SP40/50/57W	100W/120W/150W	24000Lm	4K/5K/5700K	Bronze	120V-277V	0-10V	UL & DLC
156796	BLT-S-G12C-300WBT3DA2-BR10SP40/50/57W	200W/240W/300W	48000Lm	4K/5K/5700K	Bronze	120V-277V	0-10V	UL & DLC
156800	BLT-S-G12C-300WBT3DA2-BR10SP40/50/57W	200W/240W/300W	48000Lm	4K/5K/5700K	Black	120V-277V	0-10V	UL & DLC
156797	BLT-S-G12C-300WBT3SH2-BR10SP50	200W/240W/300W	48000Lm	4K/5K/5700K	Black	277V-480V	0-10V	UL & DLC

### SKU: 156752

### Specifications

Parameter	Description	Value
General Performance	Model #	BLT-S-G12C-150WBT3SA2-BR10SP50W
	Wattage Adjustable	100W / 120W / 150W
	Lumen	Up to 24000LM
	Lumen Efficacy	Up to 160LM/W
	Color Temperature	4000K / 5000K / 5700K
	CRI (Ra)	>80
	Beam Angle	150 * 90 Degree
	Distribution Pattern	Type III
Electrical	Input Voltage	120-277Vac
	Frequency	50/60Hz
	Dimming	0-10V Dimmable
	PF	≥0.9
	Driver Brand	Beyond
	Driver Model	SS-160NH-E260BH
	Surge Protector	L/N-PE: 10kV, L-N: 10kV
Physical	Operating Temperature	Without Motion Sensor: -40°C TO 50°C; With Motion Sensor: -30°C TO 50°C
	Storage Temperature	-40°C TO 80°C
	Operating Humidity	20% - 90% RH
	Storage Humidity	10% - 95% RH
	LED Brand	Lumileds
	LED Type	SMD2835
	LED QTY	364 Pcs
Housing	Die-cast aluminum	
Qualification	Housing Color	Bronze
	IP Rating	IP65
	Warranty	5 Year



# ZOHO™

## 6th Gen

**SKU: 156796/156800**

### Specifications

Parameter	Description	Value
General Performance	Wattage Adjustable	200W / 240W / 300W
	Lumen	Up to 48000LM
	Lumen Efficacy	Up to 160LM/W
	Color Temperature	4000K / 5000K / 5700K
	CRI (Ra)	>80
	Beam Angle	150 * 90 Degree
	Distribution Pattern	Type III
	Input Voltage	120-277Vac
Electrical	Frequency	50/60Hz
	Dimming	0-10V Dimmable
	PF	≥0.9
	THD (Tolerance: -3%)	≤20%
	Flicker Percent	<5%
	Driver Brand	Beyond
	Driver Model	SS-320NH-E260BH
Surge Protector	L/N-PE: 10kV, L-N: 10kV	
Physical	Operating Temperature	Without Motion Sensor: -40°C TO 50°C; With Motion Sensor: -35°C TO 50°C
	Storage Temperature	-40°C TO 80°C
	Operating Humidity	20% - 90% RH
	Storage Humidity	10% - 95% RH
	LED Brand	Lumileds
	LED Type	SMD2835
	LED QTY	728 Pcs
Qualification	Housing	Die-cast aluminum
	Housing Color	Bronze/Black
	IP Rating	IP65
	Warranty	5 Year

# ZOHO™

## 6th Gen



**SKU: 156797**

### Specifications

Parameter	Description	Value
General Performance	Model	BLT-S-G12C-300WBT3SH2-BR10SP50
	Wattage Adjustable	200W / 240W / 300W
	Lumen	Up to 48000LM
	Lumen Efficacy	Up to 160LM/W
	Color Temperature	4000K / 5000K / 5700K
	CRI (Ra)	>80
	Beam Angle	155 * 85 Degree
	Distribution Pattern	Type III
Electrical	Input Voltage	277-480V
	Frequency	50/60Hz
	Dimming	0-10V Dimmable
	PF	≥0.9
	THD (Tolerance: +5%)	≤20%
	Flicker Percent	<5%
	Driver Brand	Beyond
Physical	Driver Model	R1-V320B-260B12
	Surge Protector	L/N-PE: 10kV, L-N: 10kV
	Operating Temperature	Without Motion Sensor: -40°C TO 50°C; With Motion Sensor: -35°C TO 50°C
	Storage Temperature	-40°C TO 80°C
	Operating Humidity	20% - 90% RH
	Storage Humidity	10% - 95% RH
	LED Brand	Lumileds
	LED Type	SMD2835
	LED QTY	728 Pcs
	Housing	Die-cast aluminum
Qualification	Housing Color	Black
	IP Rating	IP65
	Warranty	5 Year

LED AREA LIGHT



# ZOHO™ 6th Gen

## Correlated Color Temperature (CCT)

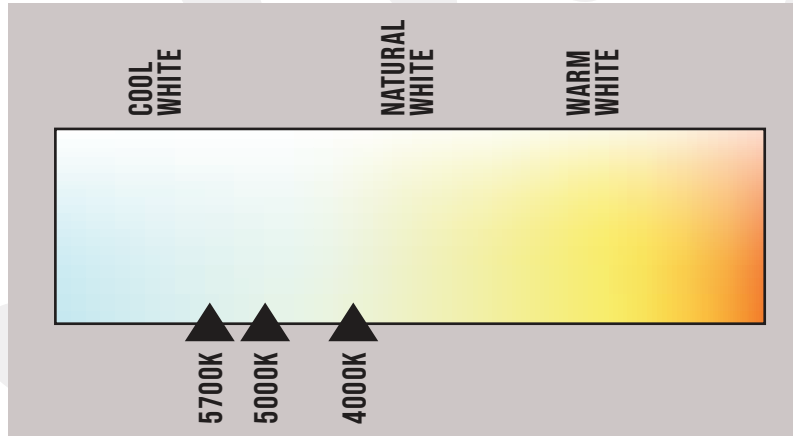

## Optional Photocell



SKU #. 110786

## Wattage & CCT Adjustable

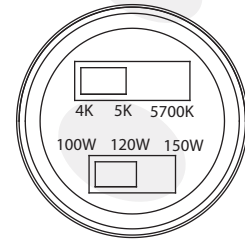

## Dimensions

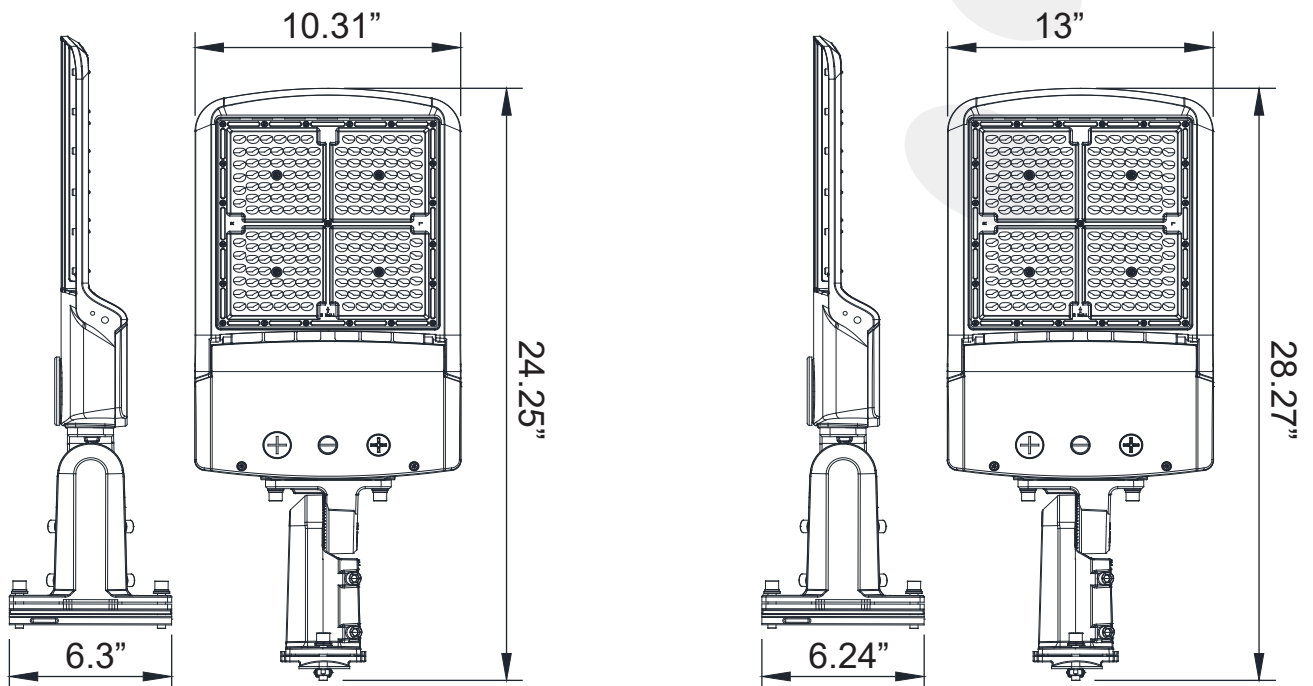



## Distribution Curve

### Luminaire Property

Luminaire Manufacturer:

Voltage: 121.3 V

Power: 150.60 W

Current: 1.244 A

Power Factor: 0.998

### Photometric Results

IES Classification: Type IV

Total Rated Lamp Lumens: 22873.9 lm

Efficiency: 100%

Upward Ratio: 1%

Central Intensity: 5178.94 cd

Pos of Max. Intensity: H180 V64

Longitudinal Classification: Short

Measurement Flux: 22873.9 lm

Downward Ratio: 99%

Luminaire Efficacy Rating (LER): 151.93

Max. Intensity: 7839.14 cd

Luminous Intensity Distribution Curve

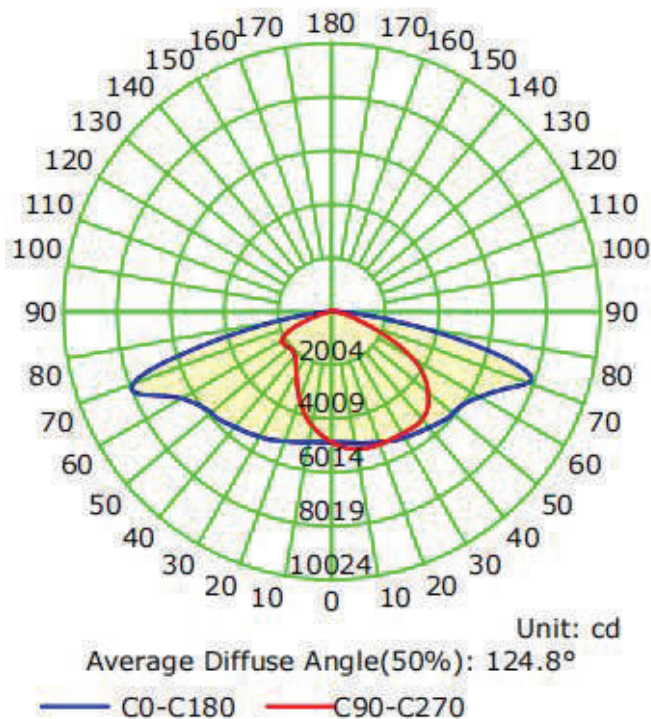

The Average Illuminance Effective Figure

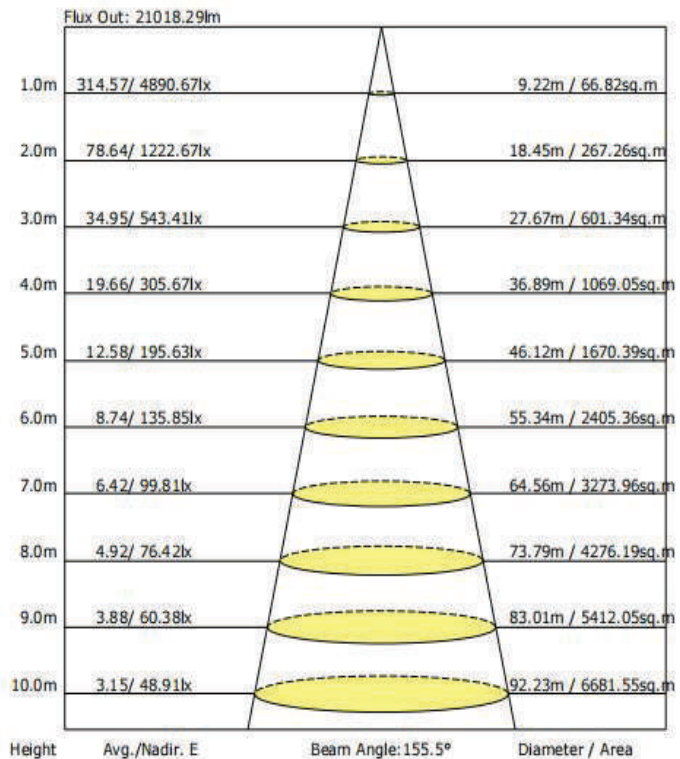





# ZOHO™ 6th Gen

## Installation

### Cautions:

1. Can not use the electric generator to test the LED lamp.
2. Please abide by related country, regional and local law and regulations when install this fixture.
3. To avoid electrical shock and damage, please do not install the lights in raining days.

### Notices:

1. To prevent from electric shock or fire risk, the installation must be conducted by operator who have professional electrical knowledge.
2. Please wear gloves to avoid injury before installing lamps.
3. During or after installation, if there are situations such as smoke, fire in the wires or lam please turn off the power immediately and notify relevant personnel of an overhaul.
4. This light can be used for outdoor installation.

### Instructions:

1. This product has dimming and non-dimming function, which differs in installation ways.
2. 3 dimming functions are available in this shoebox light:
  - (1). Constant current can be achieved by 0-10VDC dimming.
  - (2). PWM signal dimming.
  - (3). Variation of resistance unit dimming (Please choose the appropriate dimming way according to your needs. You can also choose not to use this function).
3. Choose the wire connection ways, dimming ways and installation ways according to your needs and the led fixture purchased.

### Wiring Diagram:

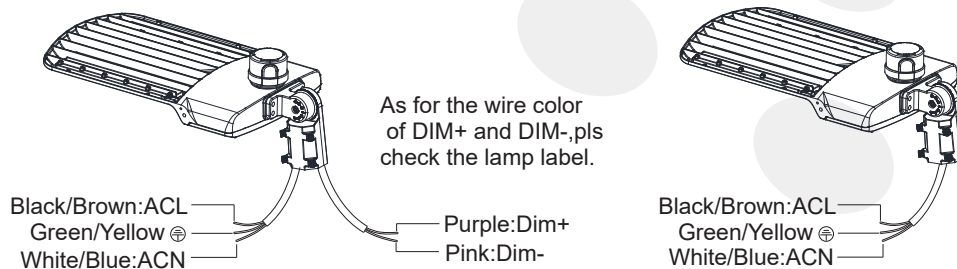

### Optional Brackets and Installation Instructions

There are 5 optional brackets for this fixture. The following is shoebox fixtures with different brackets

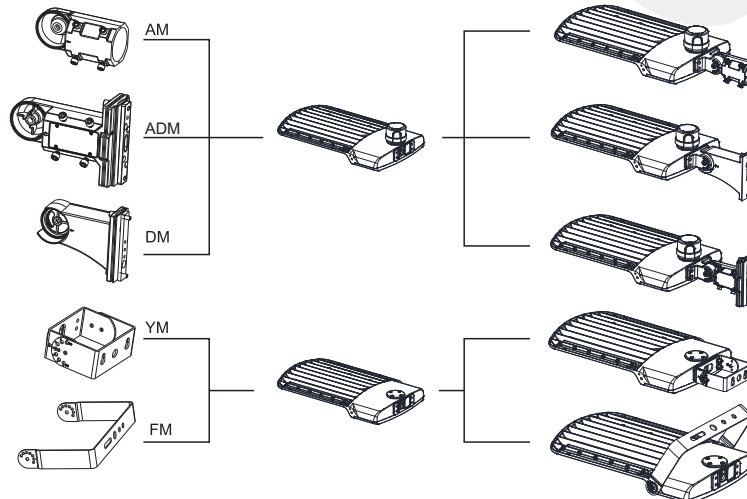



## Installation

### Installation Instructions with different brackets:

#### 1. ADJUSTABLE FITTER MOUNTING (AM)

Step 1: Remove the bracket mounting screws on the fixture and run the wires through the bracket. (Figure 1)

Step 2: Install the bracket on the fixture. (Figure 2)

#### 2. ADJUSTABLE FITTER MOUNTING & DIRECT MOUNTING (ADM)

Step 1: Remove the bracket mounting screws on the fixture, open the side lid of bracket and run the wires through the bracket. (Figure 3)

Step 2: Install the bracket on the fixture, then cover the side lid and tighten it. (Figure 4)

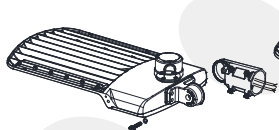

Figure 1

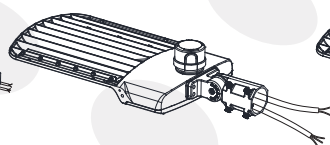

Figure 2

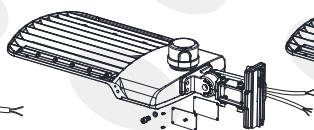

Figure 3

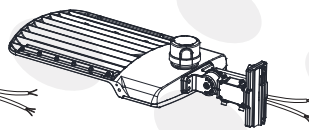

Figure 4

#### 3. DIRECT MOUNTING (DM)

Step 1: Remove the bracket mounting screws on the fixture, open the side lid of bracket and run the wires through the bracket. (Figure 5)

Step 2: Install the bracket on the fixture, then cover it and tighten it. (Figure 6)

#### 4. YOKE MOUNTING (YM)

Step 1: Remove the bracket mounting screws on the fixture and run the wires through the bracket. (Figure 7)

Step 2: Install the bracket on the fixture. (Figure 8)

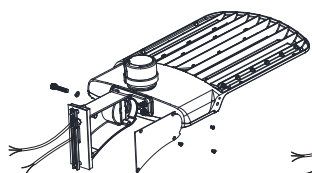

Figure 5

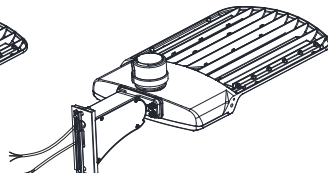

Figure 6

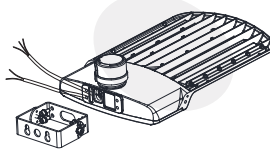

Figure 7

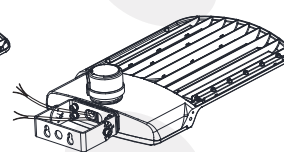

Figure 8

#### 5. FLOOD MOUNTING (FM)

Step 1: First install two big screws. (Figure 9)

Step 2: Install two small screws. (Figure 10)

#### Installation of LED Lamps:

##### 1. ADJUSTABLE FITTER MOUNTING (AM)

Step 1: Loosen the four bolts on AM bracket, connect the wires correctly, and pull the wires into the poles. (Figure 11)

Step 2: Place the bracket into the pole and lock the four bolts. (Figure 12)

Notice: Adjustable angle is 0-90° (Figure 11)

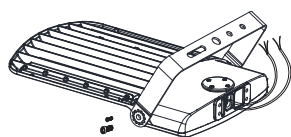

Figure 9

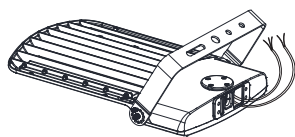

Figure 10

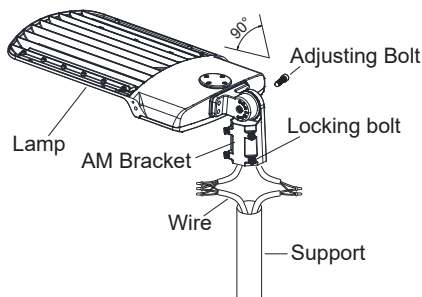

Figure 11

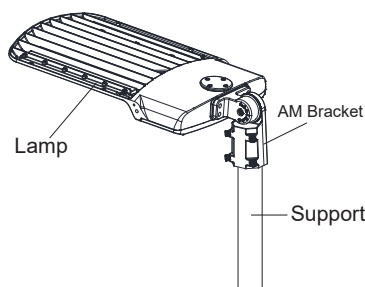

Figure 12





# ZOHO™ 6th Gen

## Installation

### 2. ADJUSTABLE FITTER MOUNTING & DIRECT MOUNTING (ADM)

#### 2.1 ADJUSTABLE FITTER MOUNTING

Step 1: Remove the spare parts from ADM bracket. (Figure 13).

Step 2: Loosen the four bolts on ADM bracket, connect the wires correctly and pull the wires into the poles. (Figure 14)

Step 3: Place the bracket into the pole and lock the four bolts. (Figure 14)

Notice: Adjustable angle is 0-90°(Figure 14)

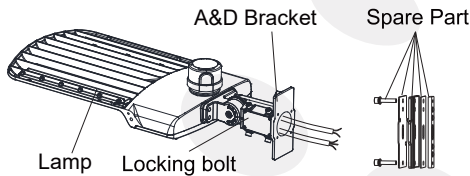

Figure 13

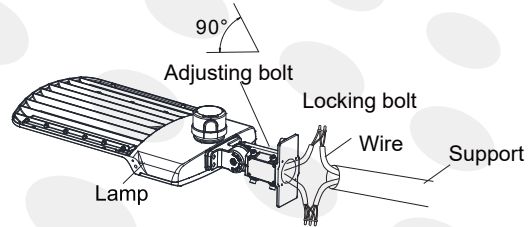

Figure 14

#### 2.2 DIRECT MOUNTING

Step 1: Remove the four bolts from ADM bracket, remove the four rubber plugs from installation bar, put the four rubber plugs on the place where the four bolts were previously placed on the bracket for waterproof purpose (Figure 15)

Step 2: Fix ADM bracket to square pole with bolt, open the cover of ADM bracket junction box, pull the wire into bracket junction box, connect the wire properly and cover the junction box. (Figure 16)

Notice: Adjustable angle is 0-90°. (Figure 16)

Same as round pole installation, please remember to use the adapting plate for round pole installation (Figure 17)

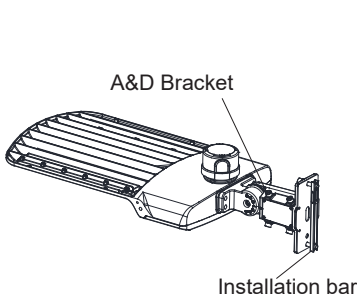

Figure 15

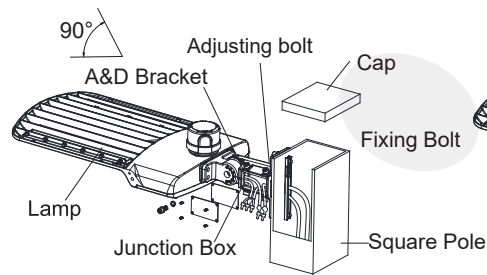

Figure 16

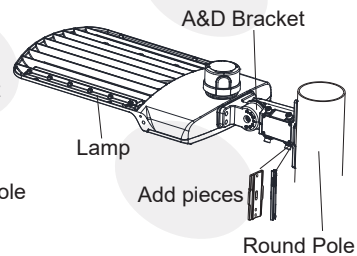

Figure 17

### 3. DIRECT MOUNTING (DM)

Step 1: Fix DM bracket to square pole with bolt, open the side lid of DM bracket, pull the wire into junction box, and connect the wire correctly. (Figure 18)

Step 2: Put the connected wire into the junction box, then cover the junction box.(Figure 19)

Notice: Adjustable angle is 0-35°(Figure 18).

Same as round pole installation, please remember to remove the silicon plate when install the fixture in round pole (Figure 20)

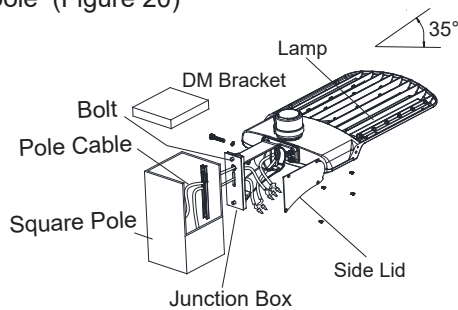

Figure 18

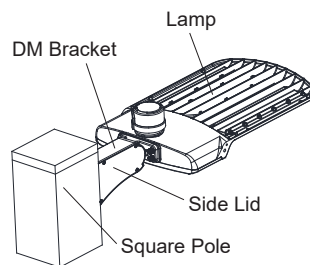

Figure 19

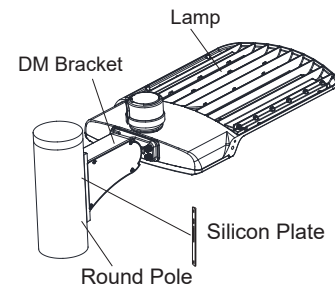

Figure 20

# ZOHO™ 6th Gen



## Installation

### 4. YOKE MOUNTING (YM)

Step 1: Drill holes on the wall as shown. (Figure 21)

Step 2: Knock the expansion bolts into the wall. (Figure 22)

Step 3: Connect the fixture to the bracket and tighten the screws; connect the wires properly and put them into junction box. (Figure 23)

Notice: Adjustable angle is 0-90°(Figure 23)

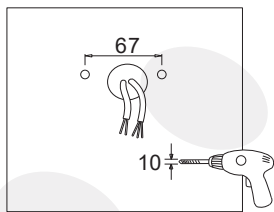

Figure 21

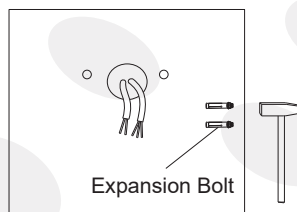

Figure 22

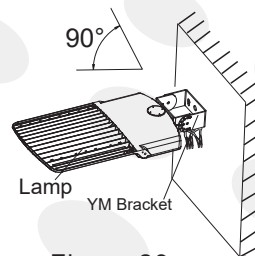

Figure 23

### 5. FLOOD MOUNTING (FM)

Install the mount to the fixture, tighten the mount and install the screws. (Figure 24)

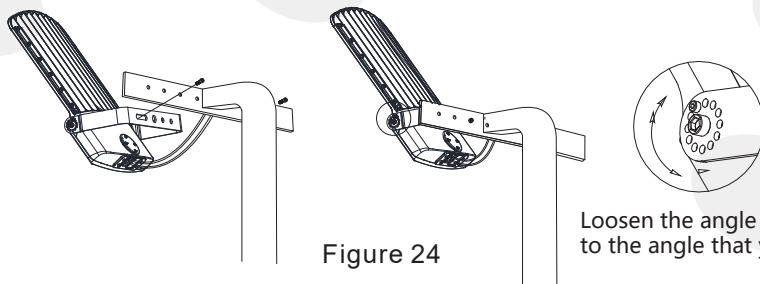

Figure 24

Loosen the angle to adjust the screw, after adjust to the angle that you need, then tighten the screws.

### Instructions for Photocell

When the photocell function is required, photocell should be installed on the back of lamp; When it's not required, shorting cap should be installed on the back of lamp (Figure 25)

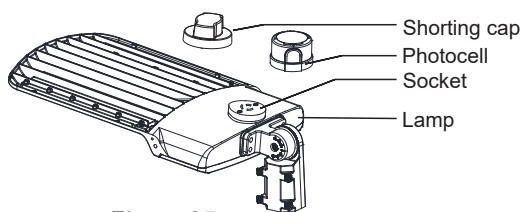

Figure 25

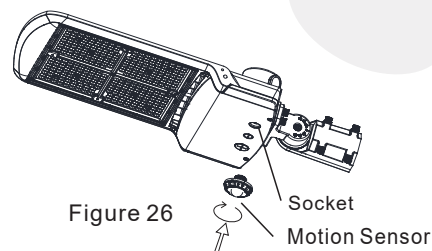

Figure 26

### Standard wire:

L/live wire: Black\Brown;

N/null wire: White\Blue;

Ground wire: Green\Yellow-green.

### Instructions for Motion Sensor

For products with motion sensor function, the induction module should be installed on the socket of the motion sensor. (Figure 26)



# ZOHO™ 6th Gen

## Installation

### Instructions for Motion sensor (Figure 26)

Technical data	
Operating voltage	12±2V DC
Operating current	30mA
Output	DIM 0-10V
Stand-by power	<0.5W
Brightness	0%-100%/Quick setting:70%/80%/90%/100%
Sensitivity	20%/50%/75%/100%
Hold time	10s/1min/10min/30min
Daylight threshold	10Lux/30Lux/50Lux/100Lux/Disable
Stand-by time	1min/30min/60min/+∞
Stand-by dimming level	10%/20%/30%/50%
Microwave frequency	5.8GHz±75MHz
Microwave power	<0.5mW
Detection angle	150° (wall mounted) 360° (ceiling mounted)
Control line	Pink:+12V; Purple:DIM+; Gray:GND/DIM-
Mounting height	Max.15m(ceiling mounted)
Detection range	Max.ø15m(ceiling mounted) Max.20m(wall mounted)
Operating temperature	-30°C~+60°C
IP rating	IP20

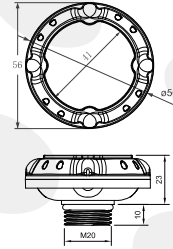
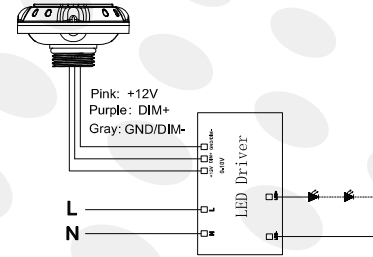

#### Note:

Default setting: Brightness:100%, Hold time:1min, Stand-by dimming level:20%, Stand-by time:1min, Sensitivity:100%, Daylight:Disable.

#### CCT Adjustment

1. Unscrew the 3/4 plug, as shown in the figure 27.
2. Adjust the switch to get the desired color temperature according to the content on the label.
3. Install and tighten the 3/4 plug.

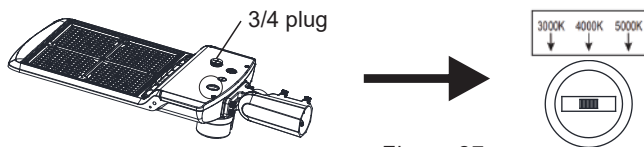

Figure 27

#### CCT Adjustment and Wattage adjustment Instruction

1. Unscrew the 3/4 plug, as shown in the figure 28;
2. Adjust the wattage switch or CCT switch to get the desired wattage or color temperature according to the label on the fixture
3. Install and tighten the 3/4 plug.

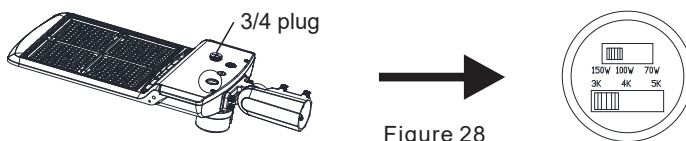

Figure 28



## Installation

### Instructions for PIR sensor (Figure 26)

Technical data	
Operating voltage	12±2V DC
Operating current	30mA
Output	DIM 0-10V
Stand-by power	<0.5W
Brightness	0%-100%/Quick setting:70%/80%/90%/100%
Sensitivity	20%/50%/75%/100%
Hold time	10s/1min/10min/30min
Daylight threshold	10Lux/30Lux/50Lux/100Lux/Disable
Stand-by time	1min/30min/60min/+∞
Stand-by dimming level	10%/20%/30%/50%
Detection angle	30-120°
Control line	Pink:+12V; Purple:DIM+; Gray:GND/DIM-
Mounting height	Max.6m(ceiling mounted)
Detection range	Max.∅ 8m(ceiling mounted) Max.6m(wall mounted)
Operating temperature	-30°C~+60°C
IP rating	IP20

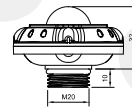
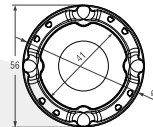
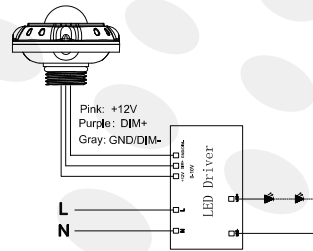

**Note:**

Default setting: Brightness:100%, Hold time:1min, Stand-by dimming level:20%, Stand-by time:1min, Sensitivity:100%, Daylight:Disable.

### ⚠ WARNING

**NOTE:** Warm up time is 15seconds. After the sensor connects input power first time, the light will keep on 15seconds, then go to dimming to work normally.

**NOTE:** Factory Default Setting: 100% sensitivity, Hold on time: 10seconds, Daylight sensor is 30lux, Dimming level: 30%,Dimming time: 60minutes.

**NOTE:** Any setting changed by DIP Switch or remote control, the led light that sensor connect will on/off as confirm.

THIS PRODUCT MUST BE INSTALLED IN ACCORDANCE WITH THE APPLICABLE INSTALLATION CODE BY A PERSON FAMILIAR WITH THE CONSTRUCTION AND OPERATION OF THE PRODUCT AND THE HAZARDS INVOLVED.

CAUTION - RISK OF FIRE. CONSULT A QUALIFIED ELECTRICIAN TO ENSURE CORRECT BRANCH CIRCUIT CONDUCTOR MIN 75°C SUPPLY CONDUCTORS

CE PRODUIT DOIT ÊTRE INSTALLÉ SELON LE CODE D'INSTALLATION PERTINENT, PAR UNE PERSONNE QUI CONNAÎT BIEN LE PRODUIT ET SON FONCTIONNEMENT AINSI QUE LES RISQUES INHÉRENTS

ATTENTION – RISQUE D'INCENDIE. CONSULTER UN ÉLECTRICIEN QUALIFIÉ POUR VOUS ASSURER QUE LES CONDUCTEURS DE LA DÉRIVATION SONT ADÉQUATS LES FILS D'ALIMENTATION 75 °C MIN



# ZOHO™ 6th Gen

## Notice For User

- Please turn off power before install or change assembly parts.
- The input voltage and lamps should be matched, after connecting the power line, Please make sure the wiring section is insulated.
- No-professionals, must not install and disassemble the lamps.

## TROUBLE SHOOTINGS

Troubles	Check Points
Flickering of the light	Turn off the power and turn on again in 3 minutes. If same phenomena occur, then call agencies.
Out of working	Please check the connection.

## Packaging

SKU	Size (Inches)	Qty	Net Weight	Gross Weight
156752	24.61 x 12.20 x 5.63	1	9.03 LBS	11.46 LBS
156796	29.13 x 14.96 x 5.63	1	11.90 LBS	14.99 LBS
156800	29.13 x 14.96 x 5.63	1	11.90 LBS	14.99 LBS
156797	29.13 x 14.96 x 5.63	1	11.90 LBS	14.99 LBS

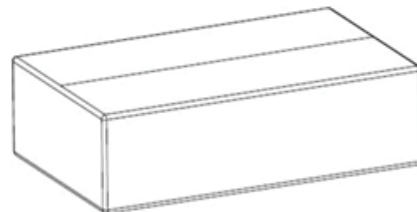
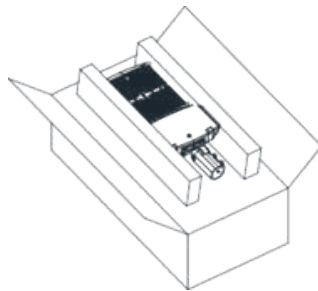

## Warranty

5 Year Warranty



# ZOHO™ 6th Gen



## Application Image



LED AREA LIGHT