

NATRON™

Solar Area Light

Beyond Solar presents this Solar Street light with an extremely simple way of installation compared to traditional lead acid battery systems. Natron enjoys a smart and unique design together with the best components available on the market. Using a LIFEPO4 Battery, MPPT controller, it's made in Aluminum, making it the most powerful and reliable solution.

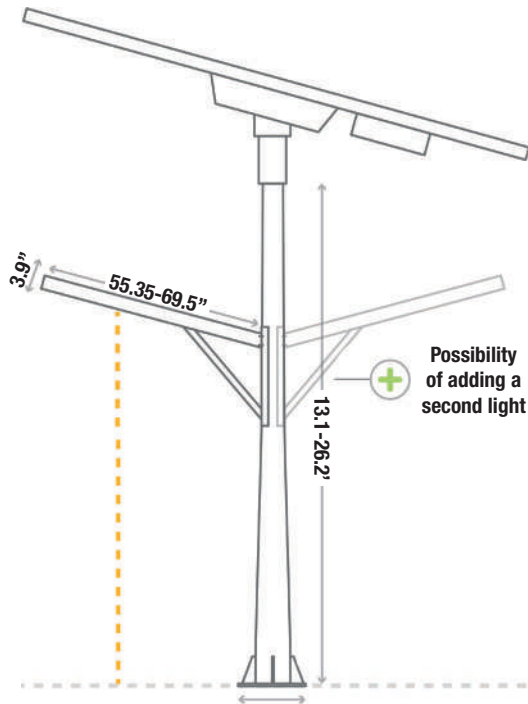

- Maximum power point tracking charging
- Auto identify day/night
- 4 levels dimming design
- Smart mode operation
- Waterproof IP66
- Optimal component calibration and intelligent management system
- Selection of the latest and highest component technology
- The Eco-friendly and safe LiFePO4 battery improves the cyclic charge and discharge over 2000 times and has a life span of more than 10 years.
- MPPT (Maximum Power Point Tracking) controller automatically track the maximum power point according to the weather variation.
- 5 Years limited warranty on all components



NATRON™

Solar Area Light

Specifications

Model #	SKU #	Power	PV Type	Solar Panel	Lithium Battery	Lumens	CCT	Controller	Beam Angle	Installation Height (Ft)
AVS-SSLXPRO-30W	786159	30W	MONO	125W	36AH 12.8V	4500LM	3K / 6K	MPPT	120°	15
AVS-SSLXPRO-40W	786158	40W	MONO	135W	49AH 12.8V	6000LM	3K / 6K	MPPT	120°	18
AVS-SSLXPRO-60W	786157	60W	MONO	195W	72AH 12.8V	9000LM	3K / 6K	MPPT	120°	20
AVS-SSLXPRO-80W	786156	80W	MONO	210W	90AH 12.8V	12000LM	3K / 6K	MPPT	120°	20
AVS-SSLXPRO-100W	786155	100W	MONO	285W	58.5AH 25.6V	15000LM	3K / 6K	MPPT	120°	25
AVS-SSLXPRO-250	786160	2X50W	MONO	285W	58.5AH 25.6V	15000LM	3K / 6K	MPPT	120°	25



ANTI BLACK OUT

Optimal component calibration and intelligent management system



UNEQUALED LIFETIME

Selection of the latest and highest component technology



EXTREME TEMPERATURE

Resistant
-4 °F to 149°F



NATRON™ Solar Area Light

Product Design and Benefits



SOLAR PANEL

+ EASY MAINTENANCE
with a direct access to battery and controller.



SAFE
No explosion risk

MICROWAVE MOTION SENSOR

LED FIXTURE



BATTERY LITHIUM LIFEPO4

The Eco-friendly and safe LiFePO4 battery improves the cyclic charge and discharge over 2000 times and has a life span of **more than 10 years**.



BATTERY MANAGEMENT SYSTEM

Electronic Algorithm Protection and battery management system for **best use of the battery capacity**.



MULTI PROTECTION

- OVER LOAD
- OVER CURRENT
- OVER TEMPERATURE
- OVER VOLTAGE
- OVER CHARGE
- OVER DISCHARGE

LIFEPO4	VS	LI ION
Over 2000 cycles		Over 500 cycles
No Risk of Explosion		Very High Risk Explosion in High Temperature
-10 to 75 Degree		0 to 45 Degree
Over 10 Years		24 to 32 Months
		50% Cheaper than LiFePO4

MPPT / SMART CONTROLLER 97% CHARGING EFFICIENCY

MPPT (Maximum Power Point Tracking) controller automatically track the maximum power point according to the weather variation.

Charging rate : 16-30%



FEATURES

- Maximum power point tracking charging
- Auto identify day/night
- 4 levels dimming design
- Smart mode operation
- Waterproof IP66

IP66

IR REMOTE CONTROL MONITORING

- Check the state of the battery
- Check the charging history
- Settle different running time slots
- Issue diagnostic

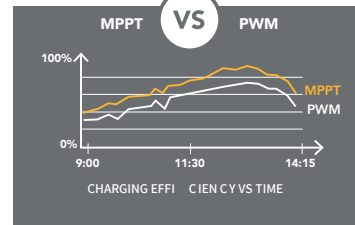

NATRON™

Solar Area Light

Motion Sensor

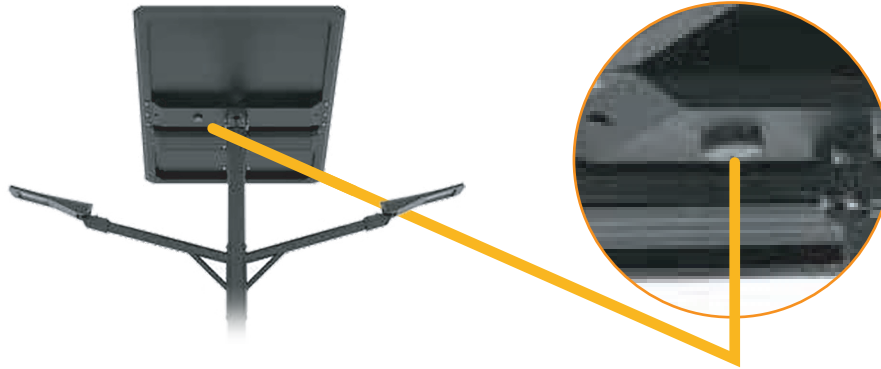

PIR OR MICROWAVE SENSOR

The light automatically switches ON at dusk and switches OFF at dawn. 30% permanent lighting, when presence is detected power turn to 100%.

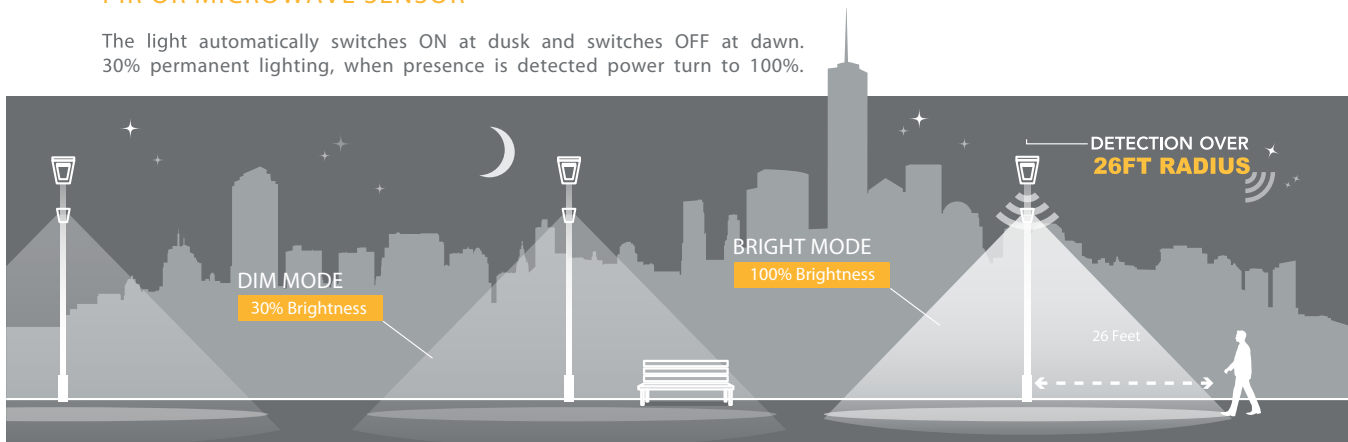

Correlated Color Temperature

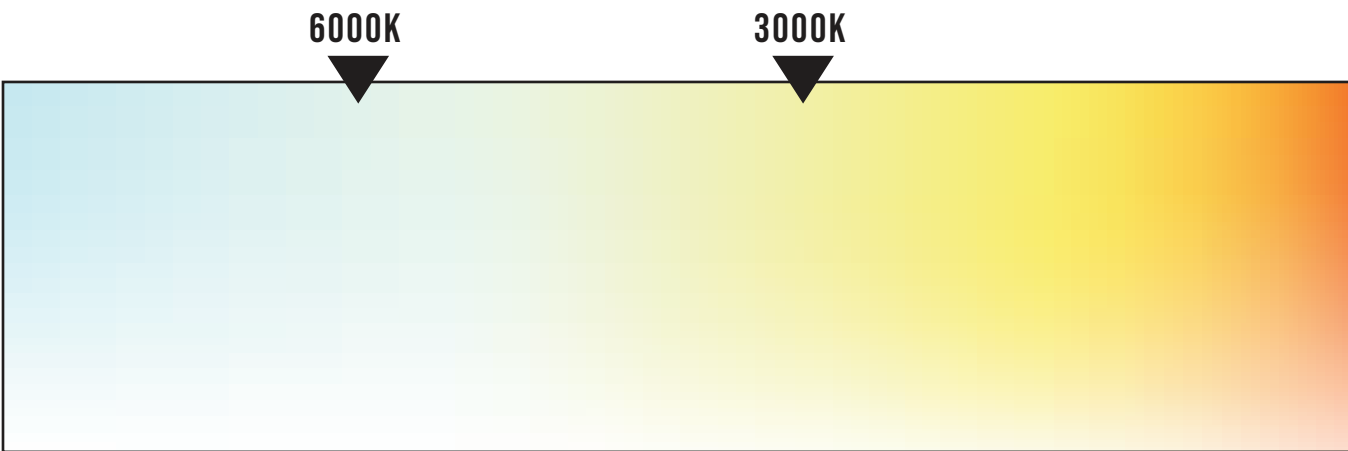

COOL WHITE

NATURAL WHITE

WARM WHITE



NATRON™

Solar Area Light

Lithium LifePO4 Battery

OVER
10
YEARS
LIFE SPAN

The SSLXPRO Series is equipped with Iron Phosphate Lithium LiFePo4 battery. This technology is proven to be the **best chemical technology for solar** application on the market.

With a cycle life of **over 4000 Cycles @ 80% DOD**, the battery has **over 10 years lifespan**.

EASY MAINTENANCE & ANTI THEFT SCREWS



Easy and direct access to the battery casing for maintenance. The fixation are made with **anti theft screws**, which request special tooling to unscrew.

ELECTRONIC PROTECTION BATTERY MANAGEMENT SYSTEM (BMS)



The electronic algorithm **protects the battery** from operating outside its safe area. Monitoring its state, calculating secondary data, reporting that data, controlling its environment, authenticating it and / or balancing it.

The BMS offers **MULTI PROTECTION** :

- OVER/UNDER LOAD
- OVER CHARGE & DISCHARGE
- OVER/UNDER CURRENT
- TEMPERATURE MANAGEMENT
- OVER/UNDER VOLTAGE

EXTREME TEMPERATURE DOWN TO 14°F

Standard Lithium LiFePo4 batteries have a working temperature range from 14°F to 158°F.

5 YEARS WARRANTY

With **Full battery Replacement**.



+ NATURAL AIRFLOW

ALUMINUM WATERPROOF CASING & NATURAL AIRFLOW

High temperatures greatly affect the battery's lifetime. This is why our batteries are encapsulated in an aluminum waterproof casing for a **perfect heat dissipation**.

In addition to that, the casing enjoy a natural airflow which keeps the battery to ambient temperature.



NATRON™

Solar Area Light

Smart MPPT Controller

SSLXPRO is equipped with a High Quality MPPT Controller, using top technology semiconductors.

FEATURES

HIGH TRANSFER EFFICIENCY

Charging efficiency up to 98%

MINIMAL STAND-BY POWER CONSUMPTION

Current consumption $\leq 10\text{mA}$

INTELLIGENT BATTERY MANAGEMENT 3 Phases charging :

MPPTT Charge / Constant Voltage / Floating Voltage.

INTELLIGENT LED DRIVER Auto detecting of Dusk and Dawn for automatic operation, 7 Lighting Programs Configuration.



ANTI BLACK OUT

ANTI BLACK OUT : Load adjust according to battery capacity assuring all night long lighting in any weather conditions.

BATTERY & SYSTEM PROTECTION :

- OVER / UNDER LOAD
- OVER / UNDER CURRENT
- OVER / UNDER VOLTAGE
- OVER CHARGE & DISCHARGE



REMOTE CONTROL MONITORING

- Check the state of the battery
- Check the charging history
- Settle different running time slots
- Issue diagnostic



NATRON™

Solar Area Light

AVS-SSLXPRO-30W

LED POWER	30 WATT
LUMINOUS FLUX	4500 LUMENS
LIGHTING	
Efficiency	150 LUMENS / WATT
Chips	PHILIPS LUXEON
LED Lifetime	OVER 50000 HOURS LM80
Lighting Angle	120 DEGREE
Light Height	13.1 FT TO 16.4 FT
STORAGE	
Technology	LITHIUM IRON PHOSPHATE LIFEPO4 - 26650
Capacity	36 AH 12.8 VOLTS
Autonomy	OVER 24 HOURS AT FULL CHARGE - 4 RAINY DAYS BACK UP
Charging time	6-7 HOURS
Lifespan	OVER 4000 CYCLES @ 80% DOD OVER 10 YEARS LIFETIME
Working Temp.	14°F TO 158°F
ENERGY	
Solar panel	125 WATTS /18V
Cells type	MONOCRYSTALLINE PANEL GRADE A 25 YEARS
Certificates	IEC 61215 ; IEC 61730 I AND II ; IEC 60904
ELECTRONIC	
Controller	MPPT SMART CONTROLLER (REMOTE MONITORING OPTIONAL)
Sensor	MICROWAVE 360 DEGREE MOTION SENSOR
Cabling	WATERPROOF CONNECTOR, PLUG AND PLAY
Protection	OVER LOAD/CURRENT/TEMP°/VOLTAGE/CHARGE/DISCHARGE
Certificates	EN 55015 ; EN 61000
MECHANICAL	
EPA (m2/ ft2)	0,428 / 4,6
Wind Load Rate	111.847 MPH
Pole Mounting Ø	3.50394 IN



NATRON™

Solar Area Light

AVS-SSLXPRO-40W

LED POWER	40 WATT
LUMINOUS FLUX	6000 LUMENS
LIGHTING	
Efficiency	150 LUMENS / WATT
Chips	PHILIPS LUXEON
LED Lifetime	OVER 50000 HOURS LM80
Lighting Angle	120 DEGREE
Light Height	13.1 FT TO 26.2 FT
STORAGE	
Technology	LITHIUM IRON PHOSPHATE LIFEPO4 - 26650
Capacity	49 AH 12.8 VOLTS
Autonomy	OVER 24 HOURS AT FULL CHARGE - 4 RAINY DAYS BACK UP
Charging time	6-7 HOURS
Lifespan	OVER 4000 CYCLES @ 80% DOD OVER 10 YEARS LIFETIME
Working Temp.	14°F TO 158°F
ENERGY	
Solar panel	135 WATTS /18V
Cells type	MONOCRYSTALLINE PANEL GRADE A 25 YEARS
Certificates	IEC 61215 ; IEC 61730 I AND II ; IEC 60904
ELECTRONIC	
Controller	MPPT SMART CONTROLLER (REMOTE MONITORING OPTIONAL)
Sensor	MICROWAVE 360 DEGREE MOTION SENSOR
Cabling	WATERPROOF CONNECTOR, PLUG AND PLAY
Protection	OVER LOAD/CURRENT/TEMP°/VOLTAGE/CHARGE/DISCHARGE
Certificates	EN 55015 ; EN 61000
MECHANICAL	
EPA (m2/ ft2)	0,660 / 7,1
Wind Load Rate	111.847 MPH
Pole Mounting Ø	3.50394 IN

SOLAR AREA LIGHT



NATRON™

Solar Area Light

AVS-SSLXPRO-60W

LED POWER	60 WATT
LUMINOUS FLUX	9000 LUMENS
LIGHTING	
Efficiency	150 LUMENS / WATT
Chips	PHILIPS LUXEON
LED Lifetime	OVER 50000 HOURS LM80
Lighting Angle	120 DEGREE
Light Height	19.7 FT TO 26.2 FT
STORAGE	
Technology	LITHIUM IRON PHOSPHATE LIFEPO4 - 26650
Capacity	72 AH 12.8 VOLTS
Autonomy	OVER 24 HOURS AT FULL CHARGE - 4 RAINY DAYS BACK UP
Charging time	6-7 HOURS
Lifespan	OVER 4000 CYCLES @ 80% DOD OVER 10 YEARS LIFETIME
Working Temp.	14°F TO 158°F
ENERGY	
Solar panel	195 WATTS /18V
Cells type	MONOCRYSTALLINE PANEL GRADE A 25 YEARS
Certificates	IEC 61215 ; IEC 61730 I AND II ; IEC 60904
ELECTRONIC	
Controller	MPPT SMART CONTROLLER (REMOTE MONITORING OPTIONAL)
Sensor	MICROWAVE 360 DEGREE MOTION SENSOR
Cabling	WATERPROOF CONNECTOR, PLUG AND PLAY
Protection	OVER LOAD/CURRENT/TEMP°/VOLTAGE/CHARGE/DISCHARGE
Certificates	EN 55015 ; EN 61000
MECHANICAL	
EPA (m2/ ft2)	0,660 / 7,1
Wind Load Rate	111.847 MPH
Pole Mounting Ø	3.50394 IN



NATRON™

Solar Area Light

AVS-SSLXPRO-80W

LED POWER	80 WATT
LUMINOUS FLUX	12000 LUMENS
LIGHTING	
Efficiency	150 LUMENS / WATT
Chips	PHILIPS LUXEON
LED Lifetime	OVER 50000 HOURS LM80
Lighting Angle	120 DEGREE
Light Height	19.7 FT TO 26.2 FT
STORAGE	
Technology	LITHIUM IRON PHOSPHATE LIFEPO4 - 26650
Capacity	90 AH 12.8 VOLTS
Autonomy	OVER 24 HOURS AT FULL CHARGE - 4 RAINY DAYS BACK UP
Charging time	6-7 HOURS
Lifespan	OVER 4000 CYCLES @ 80% DOD OVER 10 YEARS LIFETIME
Working Temp.	14°F TO 158°F
ENERGY	
Solar panel	210 WATTS /18V
Cells type	MONOCRYSTALLINE PANEL GRADE A 25 YEARS
Certificates	IEC 61215 ; IEC 61730 I AND II ; IEC 60904
ELECTRONIC	
Controller	MPPT SMART CONTROLLER (REMOTE MONITORING OPTIONAL)
Sensor	MICROWAVE 360 DEGREE MOTION SENSOR
Cabling	WATERPROOF CONNECTOR, PLUG AND PLAY
Protection	OVER LOAD/CURRENT/TEMP°/VOLTAGE/CHARGE/DISCHARGE
Certificates	EN 55015 ; EN 61000
MECHANICAL	
EPA (m2/ ft2)	0,660 / 7,1
Wind Load Rate	111.847 MPH
Pole Mounting Ø	3.50394 IN

SOLAR AREA LIGHT



NATRON™

Solar Area Light

AVS-SSLXPRO-100W

LED POWER	100 WATT
LUMINOUS FLUX	15000 LUMENS
LIGHTING	
Efficiency	150 LUMENS / WATT
Chips	PHILIPS LUXEON
LED Lifetime	OVER 50000 HOURS LM80
Lighting Angle	120 DEGREE
Light Height	26.2 FT
STORAGE	
Technology	LITHIUM IRON PHOSPHATE LIFEPO4 - 26650
Capacity	58,5 AH 25,6 VOLTS
Autonomy	OVER 24 HOURS AT FULL CHARGE - 4 RAINY DAYS BACK UP
Charging time	6-7 HOURS
Lifespan	OVER 4000 CYCLES @ 80% DOD OVER 10 YEARS LIFETIME
Working Temp.	14°F TO 158°F
ENERGY	
Solar panel	285 WATTS /36V
Cells type	MONOCRYSTALLINE PANEL GRADE A 25 YEARS
Certificates	IEC 61215 ; IEC 61730 I AND II ; IEC 60904
ELECTRONIC	
Controller	MPPT SMART CONTROLLER (REMOTE MONITORING OPTIONAL)
Sensor	MICROWAVE 360 DEGREE MOTION SENSOR
Cabling	WATERPROOF CONNECTOR, PLUG AND PLAY
Protection	OVER LOAD/CURRENT/TEMP°/VOLTAGE/CHARGE/DISCHARGE
Certificates	EN 55015 ; EN 61000
MECHANICAL	
EPA (m2/ ft2)	0,819 / 8,8
Wind Load Rate	111.847 MPH
Pole Mounting Ø	4.48819 IN



NATRON™

Solar Area Light

AVS-SSLXPRO-250

LED POWER	2 x 50 WATT
LUMINOUS FLUX	2 x 7 500 LUMENS
LIGHTING	
Efficiency	150 LUMENS / WATT
Chips	PHILIPS LUXEON
LED Lifetime	OVER 50000 HOURS LM80
Lighting Angle	120 DEGREE
Light Height	19.7 FT TO 26.2 FT
STORAGE	
Technology	LITHIUM IRON PHOSPHATE LIFEPO4 - 26650
Capacity	58,5 AH 25,6 VOLTS
Autonomy	OVER 24 HOURS AT FULL CHARGE - 4 RAINY DAYS BACK UP
Charging time	6-7 HOURS
Lifespan	OVER 4000 CYCLES @ 80% DOD OVER 10 YEARS LIFETIME
Working Temp.	14°F TO 158°F
ENERGY	
Solar panel	285 WATTS /36V
Cells type	MONOCRYSTALLINE PANEL GRADE A 25 YEARS
Certificates	IEC 61215 ; IEC 61730 I AND II ; IEC 60904
ELECTRONIC	
Controller	MPPT SMART CONTROLLER (REMOTE MONITORING OPTIONAL)
Sensor	MICROWAVE 360 DEGREE MOTION SENSOR
Cabling	WATERPROOF CONNECTOR, PLUG AND PLAY
Protection	OVER LOAD/CURRENT/TEMP°/VOLTAGE/CHARGE/DISCHARGE
Certificates	EN 55015 ; EN 61000
MECHANICAL	
EPA (m2/ ft2)	0,819 / 8,8
Wind Load Rate	111.847 MPH
Pole Mounting Ø	3.50394 IN

SOLAR AREA LIGHT



NATRON™

Solar Area Light

Light Distribution



AVS-SSLXPRO-30W

TYPE III-M

AVERAGE BEAM ANGLE (50%) : 116.7 DEG

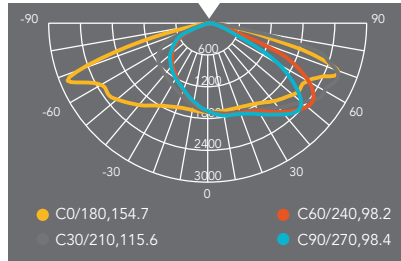

30 WATTS - 4500 LUMENS

▶ LIGHT SOURCE	3030	LED	QTY (PCS)	48	LENS (PCS)	4	CRI	> 70
----------------	------	-----	-----------	----	------------	---	-----	------

SOLAR PANEL 125 WATTS



GRADE **A**
Solar cells



AVS-SSLXPRO-40W

TYPE III-M

AVERAGE BEAM ANGLE (50%) : 116.7 DEG

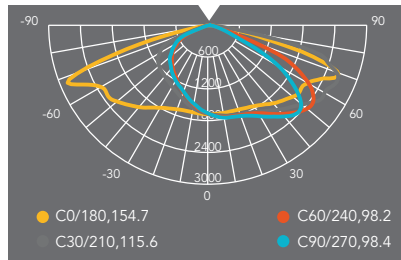

40 WATTS - 6000 LUMENS

▶ LIGHT SOURCE	3030	LED	QTY (PCS)	48	LENS (PCS)	4	CRI	> 70
----------------	------	-----	-----------	----	------------	---	-----	------

SOLAR PANEL 135 WATTS

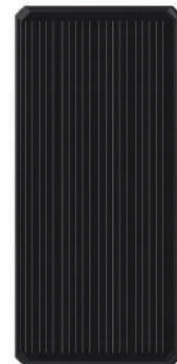

GRADE **A**
Solar cells



AVS-SSLXPRO-60W

TYPE III-M

AVERAGE BEAM ANGLE (50%) : 116.7 DEG

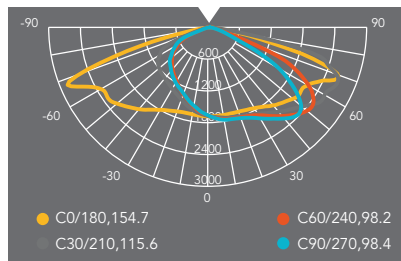

60 WATTS - 9000 LUMENS

▶ LIGHT SOURCE	3030	LED	QTY (PCS)	48	LENS (PCS)	4	CRI	> 70
----------------	------	-----	-----------	----	------------	---	-----	------

SOLAR PANEL 195 WATTS

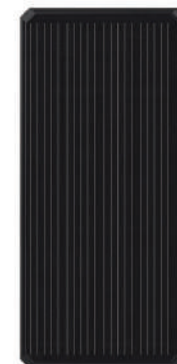

GRADE **A**
Solar cells



NATRON™

Solar Area Light

Light Distribution



AVS-SSLXPRO-80W

TYPE III-M

AVERAGE BEAM ANGLE (50%) : 116.7 DEG

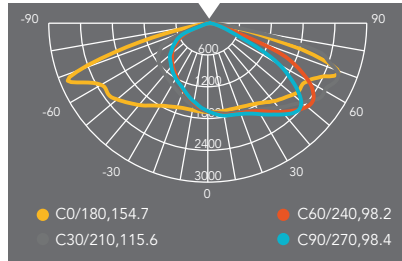

80 WATTS - 12000 LUMENS

▶ LIGHT SOURCE 3030 LED QTY (PCS) 48 LENS (PCS) 4 CRI > 70

SOLAR PANEL 195 WATTS

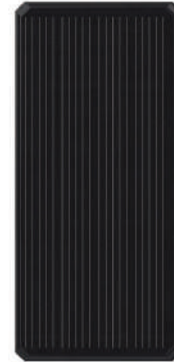

GRADE **A**
Solar cells



AVS-SSLXPRO-100W

TYPE III-M

AVERAGE BEAM ANGLE (50%) : 116.7 DEG

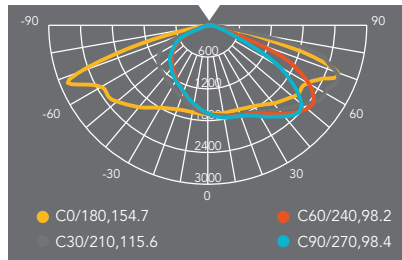

100 WATTS - 15000 LUMENS

▶ LIGHT SOURCE 3030 LED QTY (PCS) 48 LENS (PCS) 4 CRI > 70

SOLAR PANEL 285 WATTS

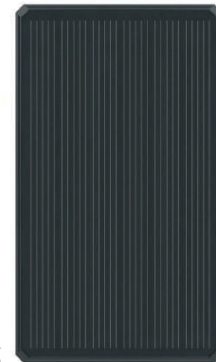

GRADE **A**
Solar cells



AVS-SSLXPRO-250

TYPE III-M

AVERAGE BEAM ANGLE (50%) : 116.7 DEG

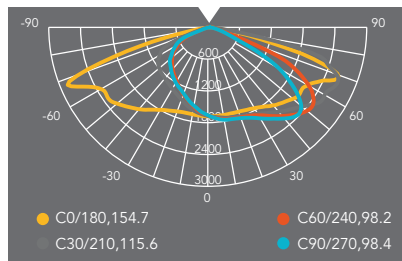

2 x 50 WATTS - 2 x 7500 LUMENS

▶ LIGHT SOURCE 3030 LED QTY (PCS) 48 LENS (PCS) 4 CRI > 70

SOLAR PANEL 285 WATTS



GRADE **A**
Solar cells

SOLAR AREA LIGHT



NATRON™

Solar Area Light

Dimensions

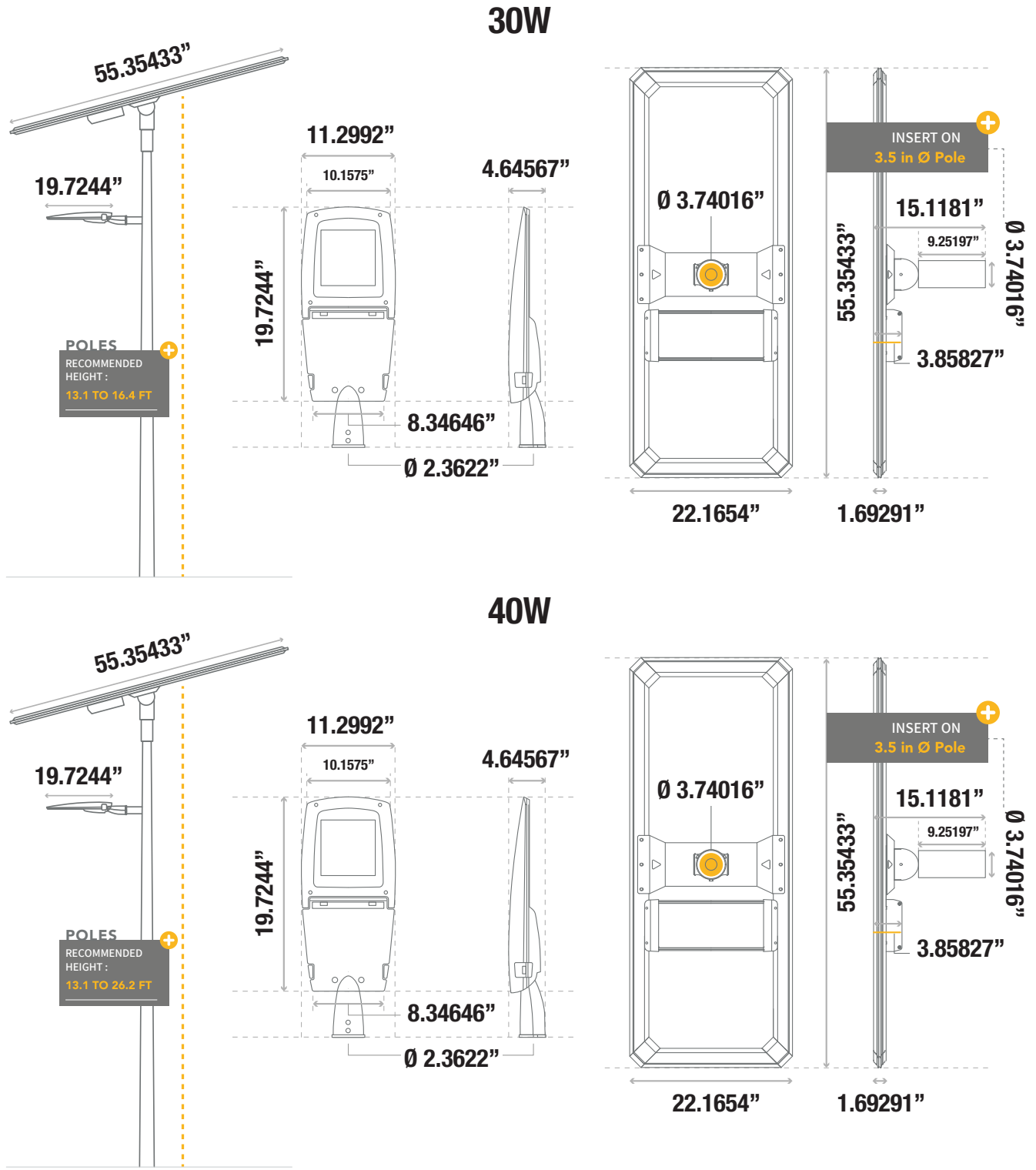

NATRON™

Solar Area Light

Dimensions

60W

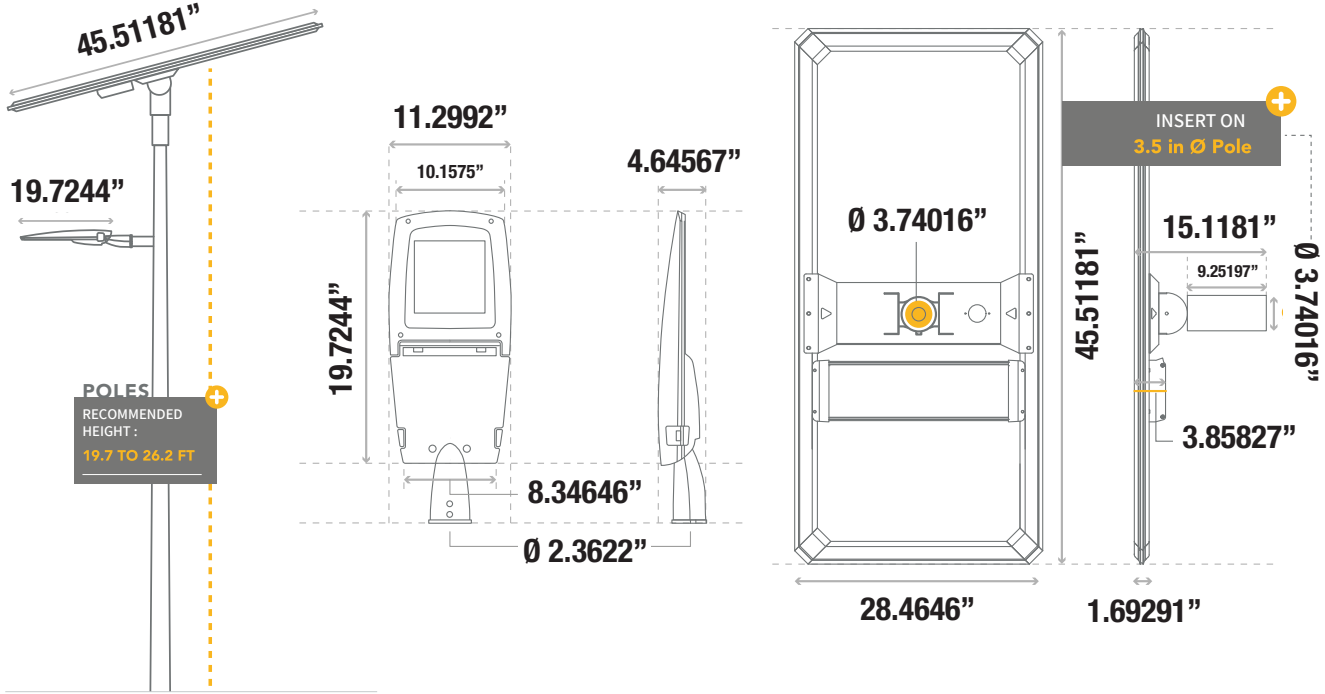

80W

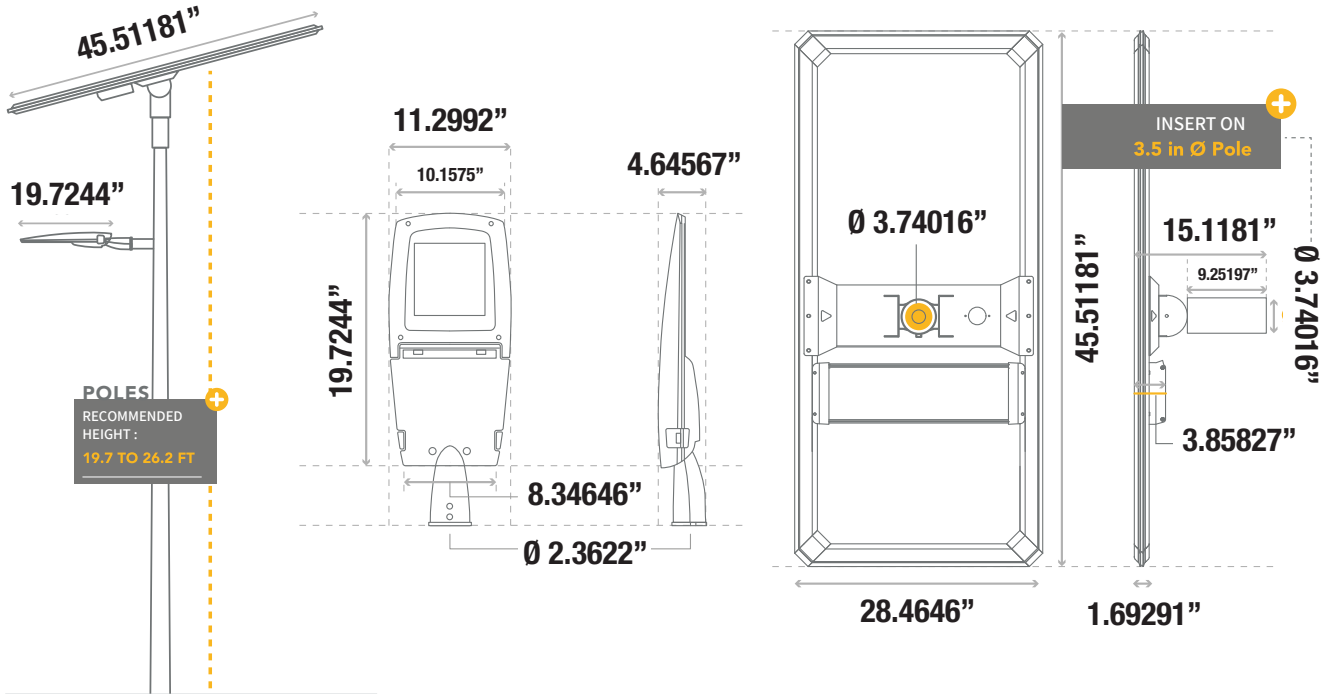

SOLAR AREA LIGHT



NATRON™

Solar Area Light

Dimensions

100W

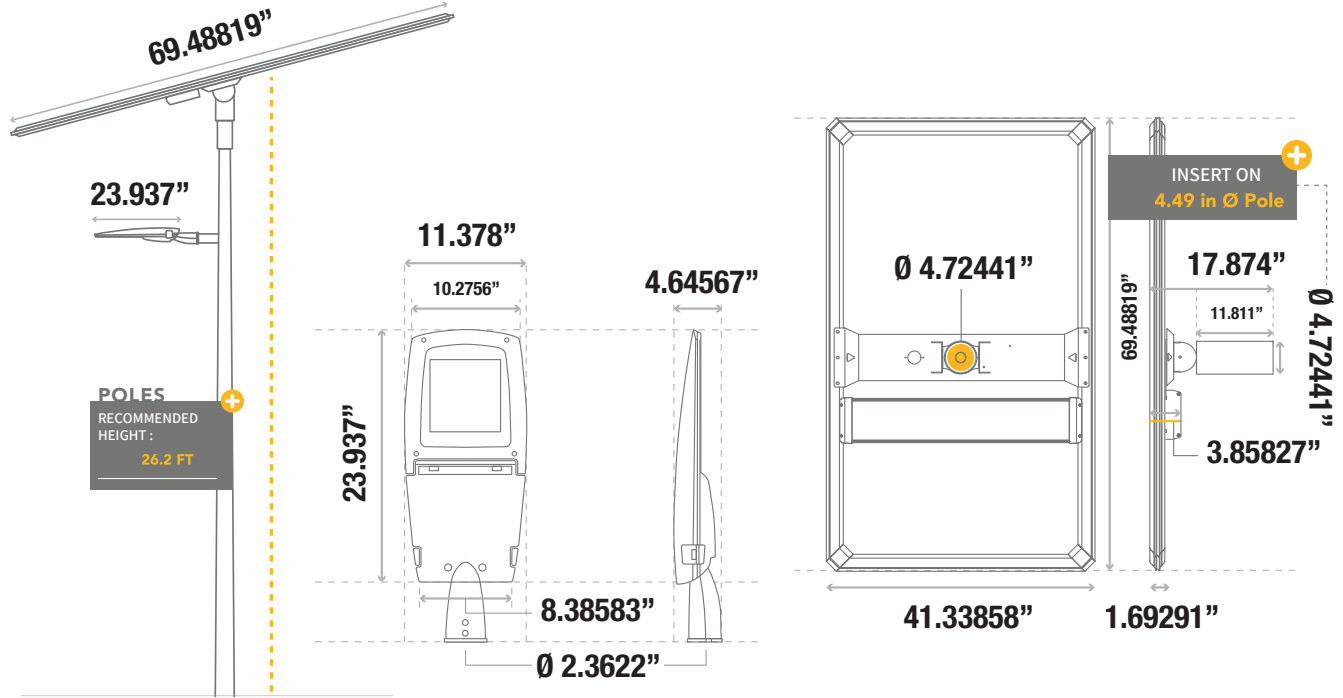

2X50W

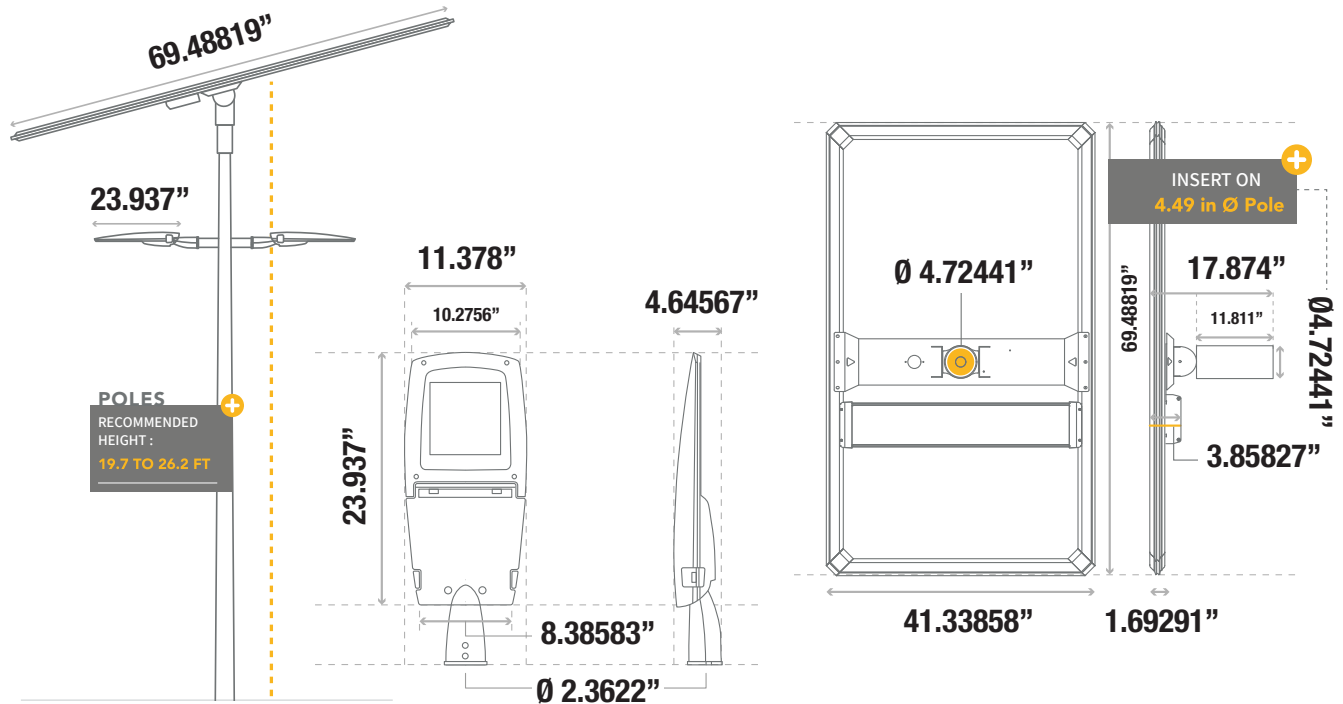

NATRON™

Solar Area Light

Installation

The installation can be adjusted according to different environments or illumination needs.



EASY INSTALLATION
ORIENTATE & CHOOSE
YOUR TILT

With an awesomely designed bracket support, the Solar SSLX PRO Street Light is very easy and flexible to install on most poles. You can rotate the panel 360 degrees to always face the sun.



NATRON™

Solar Area Light

Optimum Panel Orientation

The Solar charge in a battery pack won't last forever. The off-grid system relies on stored solar energy for autonomy. Angling your solar panels properly can boost the power intake of your solar lighting system. You want to angle your solar panels at a tilt based on the area's latitude.

Tip for Maximum Power

You can increase the tilt 15° in the winter or decrease 15° in the summer. In this way you can get the maximum sunlight to recharge the battery.

Best Facing Direction of Solar Panel

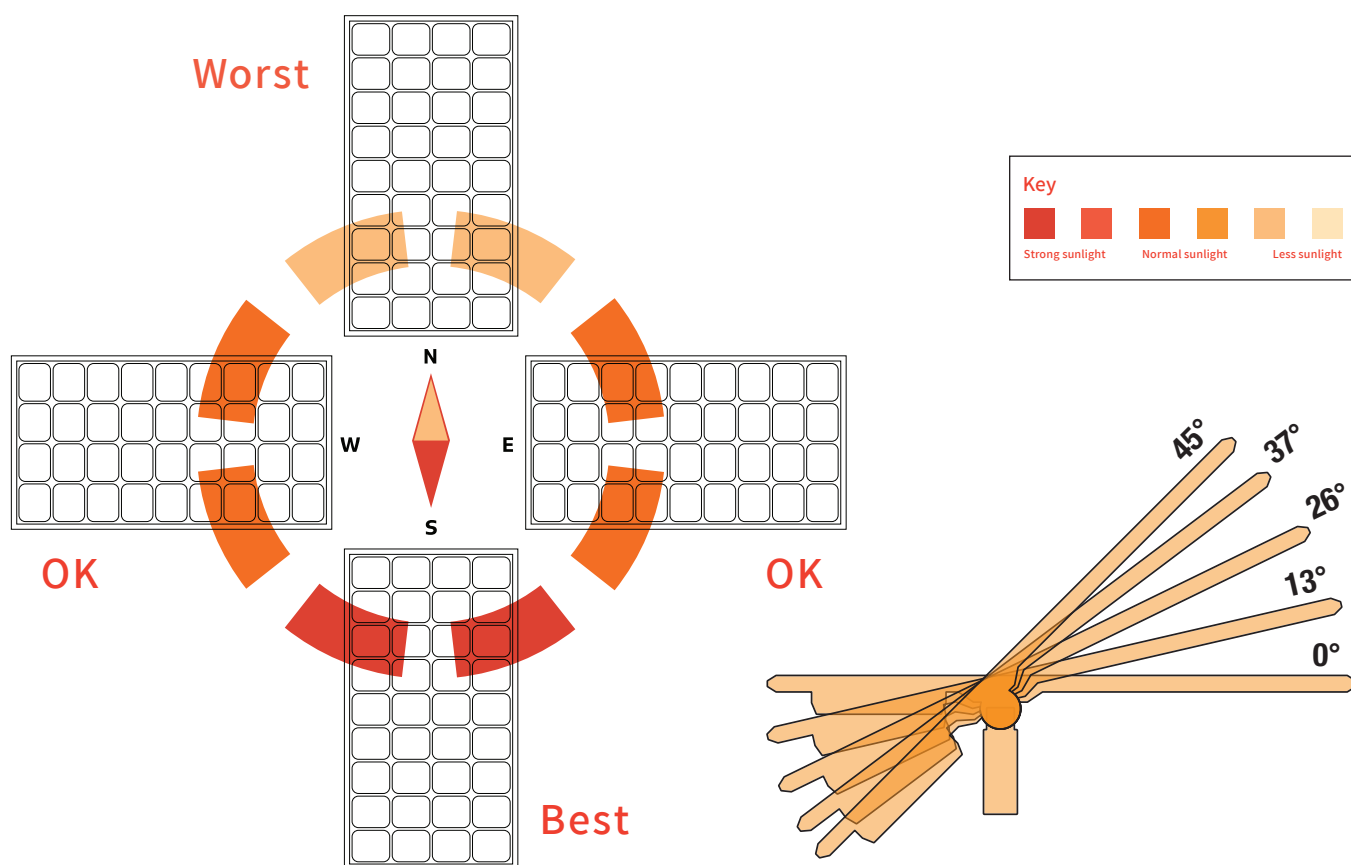

The area will dictate the installation of the fixtures and will sometimes prevent the lights from facing south. Panels facing West & East won't get as much light as Southern facing panels, but will still collect a good amount of sunlight. A North facing panel also works, but it will take longer to charge than any other direction. This would mean that the solar charge will be less optimal if installations are facing North.



NATRON™

Solar Area Light

Optimum Panel Orientation

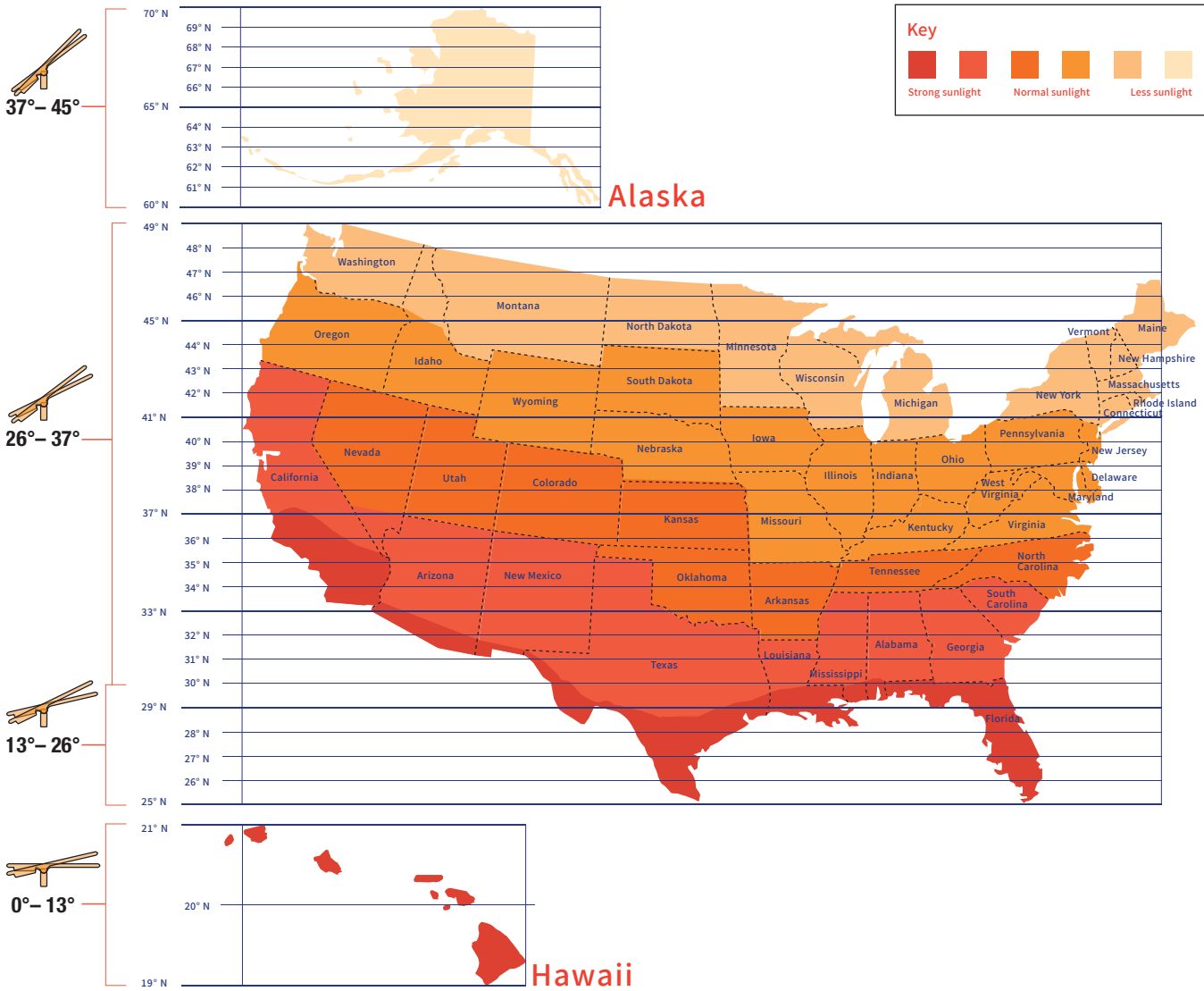

SOLAR AREA LIGHT

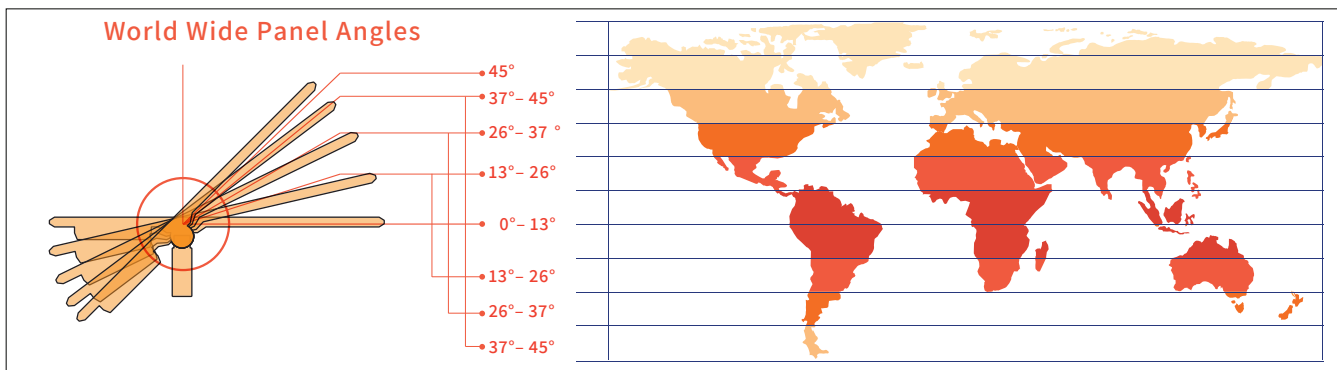

NATRON™

Solar Area Light

Packaging

AVS-SSLXPRO-30W



Unit size L x W x H	55.51181 X 22.0472 X 5.90551 IN
Carton size	57.48031 X 24.0157 X 10.2362 IN
Net weight	42.54922 LB
Gross weight	52.24956 LB
QTY per container 20" / 40" / 40"HQ	115 / 248 / 276

AVS-SSLXPRO-40W



Unit size L x W x H	55.51181 X 22.0472 X 5.90551 IN
Carton size	57.48031 X 24.0157 X 10.2362 IN
Net weight	42.54922 LB
Gross weight	52.24956 LB
QTY per container 20" / 40" / 40"HQ	115 / 248 / 276

AVS-SSLXPRO-60W



Unit size L x W x H	61.41732 X 28.5433 X 5.90551 IN
Carton size	63.38583 X 30.315 X 7.67717 IN
Net weight	60.1862 LB
Gross weight	67.68191 LB
QTY per container 20" / 40" / 40"HQ	90 / 190 / 223

AVS-SSLXPRO-80W



Unit size L x W x H	61.41732 X 28.5433 X 5.90551 IN
Carton size	63.38583 X 30.315 X 7.67717 IN
Net weight	62.83174 LB
Gross weight	69.44561 LB
QTY per container 20" / 40" / 40"HQ	90 / 190 / 223

AVS-SSLXPRO-100W



Unit size L x W x H	69.68504 X 41.73228 X 5.90551 IN
Carton size	72.04724 X 43.70079 X 9.25197 IN
Net weight	89.28722 LB
Gross weight	94.7988 LB
QTY per container 20" / 40" / 40"HQ	49 / 101 / 113

AVS-SSLXPRO-250



Unit size L x W x H	69.68504 X 41.73228 X 5.90551 IN
Carton size	72.04724 X 43.70079 X 9.25197 IN
Net weight	93.69646 LB
Gross weight	100.3103 LB
QTY per container 20" / 40" / 40"HQ	49 / 101 / 113



NATRON™

Solar Area Light

Application

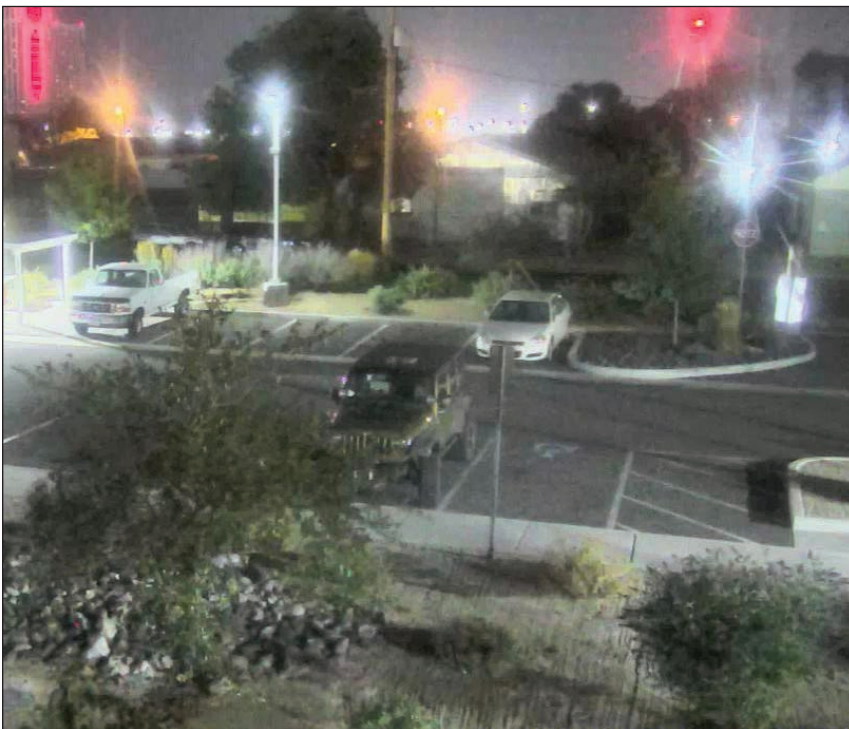

SOLAR AREA LIGHT

