



CROSS™

LED Corncob Bulb



The Cross Corncob from Beyond LED Technology is the newest, most innovative and feature-rich product of 2021. Cross corn lights are wattage-adjustable corn bulbs designed for fully enclosed fixtures. Cross Corn bulbs are meant to save energy in fixtures that formerly utilized metal halide or high-pressure sodium lights while maintaining a high Lumen output. These high-output LEDs are ideal for post top lights, shoebox fixtures and other high intensity lighting.

Product Features

- Up to 140 lumens per watt
- Wattage Adjustable
- Enclosure provides a water-tight seal making it suitable for outdoor application
- Integral LED driver (non-isolated), eliminates the need for an external driver or ballast
- High Quality and Efficacy Lumiled 2835 chips
- This product is IP64 rated, therefore, it is waterproof and dust proof rating
- Universal operation at 100-277Vac 50-60Hz
- Beam Angle of 360° Degree
- High-reliability internal driver
- 4KV built-in surge protector and fan-less design
- Direct replacement for Metal Halide
- 5 Year warranty
- UL & DLC Listed

CROSS™

LED Corncob Bulb



SKU #	Model #	Wattage Adj.	Lumens	CCT	IP	Housing	Input Voltage	Base	Certifications
153464	BLT-CLW08E-036W BCA1-S50K	18W/27W/ 36W	4524Lm Max	5000K	IP64	White	100V-277V	E26	UL & DLC
153465	BLT-CLW08E-063W BCA1-EXS50K	36W/54W/ 63W	8229Lm Max	5000K	IP64	White	100V-277V	Ex39	UL & DLC
156239	BLT-CLW08E-200W BCNA1-EXSP50K	150W/170W/ 200W	28400Lm Max	5000K	IP64	White	100V-277V	EX39	UL & DLC

CROSS 2nd GEN

SKU #	Model #	Wattage Adj.	Lumens	CCT Adjustable	IP	Housing	Input Voltage	Base	Certifications
156768	BLT-CLW08E-120W BCNA1-EXSP50K	80W/100W/ 120W	17040Lm	3K/4K/5K	IP64	White	100V-277V	EX39	UL



LED CORNCOB BULB



CROSS™

LED Corncob Bulb

SKU # 153464

Specifications

Parameter	Description	Value
General Performance	Model #.	BLT-CLW08E-036WBCA1-S50K
	Wattage Adjustable	18W / 27W / 36W
	Color Temperature	5000K
	Lumens Adjustable	Max 4524Lm
	Lumen Efficacy	Up to 130 LM/W
	CRI (Ra)	>80
	Diffuser Type	Clear
Electrical	Beam Angle	210° Degree
	Input Voltage	100-277V
	Frequency	50/60Hz
	PF	≥0.9
	THD	≤20%
	Flicker Percent	<30%
Physical	Equivalent	80W CFL, 150W MHL/HPS/HID
	Driver Model	Beyond Driver
	Driver Surge Protection	L-N:4kV
	Operating Temperature	-40°C TO 50°C
	Storage Temperature	-40°C TO 80°C
	Operating Humidity	20% - 70% RH
	Storage Humidity	10% - 75% RH
	LED Brand	Lumileds
	LED Type	SMD2835
	LEDs QTY	144 PCS
Qualification	Housing	PC + Aluminum
	Housing Color	White
	IP Rating	WET (IP64)
	Warranty	5 Years

LED CORNCOB BULB

CROSS™

LED Corncob Bulb



SKU # 153465

Specifications

Parameter	Description	Value
General Performance	Model #.	BLT-CLW08E-063WBCA1-EXS50K
	Wattage Adjustable	36W / 54W / 63W
	Color Temperature	5000K
	Lumens Adjustable	Max 8229Lm
	Lumen Efficacy	Up to 130 LM/W
	CRI (Ra)	>80
	Diffuser Type	Clear
Electrical	Beam Angle	182° Degree
	Input Voltage	100-277V
	Frequency	50/60Hz
	PF	≥0.9
	THD	≤20%
	Flicker Percent	<30%
Physical	Equivalent	120W CFL, 175W MHL/HPS/HID
	Driver Model	Beyond Driver
	Driver Surge Protection	L-N:4kV
	Operating Temperature	-40°C TO 50°C
	Storage Temperature	-40°C TO 80°C
	Operating Humidity	20% - 70% RH
	Storage Humidity	10% - 75% RH
	LED Brand	Lumileds
	LED Type	SMD2835
	LEDs QTY	272 PCS
Qualification	Housing	PC + Aluminum
	Housing Color	White
	IP Rating	WET (IP64)
	Warranty	5 Years

LED CORNCOB BULB



CROSS™

LED Corncob Bulb

SKU # 156239

Specifications

Parameter	Description	Value
General Performance	Model #.	BLT-CLW08E-200WBCNA1-EXSP50K
	Wattage Adjustable	150W / 170W / 200W
	Color Temperature	5000K
	Lumens Adjustable	Max 28400Lm
	Lumen Efficacy	Up to 130 LM/W
	CRI (Ra)	>80
	Diffuser Type	Clear PC
Electrical	Beam Angle	132° Degree
	Input Voltage	120-277V
	Frequency	50/60Hz
	Dimming	0-10V Dimmable
	PF	≥0.9
	THD	≤20%
	Flicker Percent	<30%
Physical	Equivalent	600W MHL/HPS/HID
	Driver Model	Beyond Driver
	Driver Surge Protection	L-N: 4kV
	Operating Temperature	-40°C TO 50°C
	Storage Temperature	-40°C TO 80°C
	Operating Humidity	20% - 70% RH
	Storage Humidity	10% - 75% RH
	LED Brand	Lumileds
	LED Type	SMD2835
	LEDs QTY	608 PCS
Qualification	Housing	PC + Aluminum
	Housing Color	White
	IP Rating	DAMP (IP64)
	Warranty	5 Year

LED CORNCOB BULB

CROSS™

LED Corncob Bulb



SKU # 156768

Specifications

Parameter	Description	Value
General Performance	Model #.	BLT-CLW08E-120WBCNA1-EXSP50K
	Wattage Adjustable	80W / 100W / 120W
	Color Temperature	3000K / 4000K / 5000K
	Lumens Adjustable	Max 17040Lm
	Lumen Efficacy	Up to 130 LM/W
	CRI (Ra)	>80
	Diffuser Type	Clear PC
Electrical	Beam Angle	132° Degree
	Input Voltage	120-277V
	Frequency	50/60Hz
	Dimming	0-10V Dimmable
	PF	≥0.9
	THD	≤20%
	Flicker Percent	<30%
Physical	Equivalent	600W MHL/HPS/HID
	Driver Model	Beyond Driver
	Driver Surge Protection	L-N: 4kV
	Operating Temperature	-40°C TO 50°C
	Storage Temperature	-40°C TO 80°C
	Operating Humidity	20% - 70% RH
	Storage Humidity	10% - 75% RH
	LED Brand	Lumileds
	LED Type	SMD2835
	LEDs QTY	608 PCS
Qualification	Housing	PC + Aluminum
	Housing Color	White
	IP Rating	DAMP (IP64)
	Warranty	5 Year

LED CORNCOB BULB



CROSS™

LED Corncob Bulb

Correlated Color Temperature (CCT)

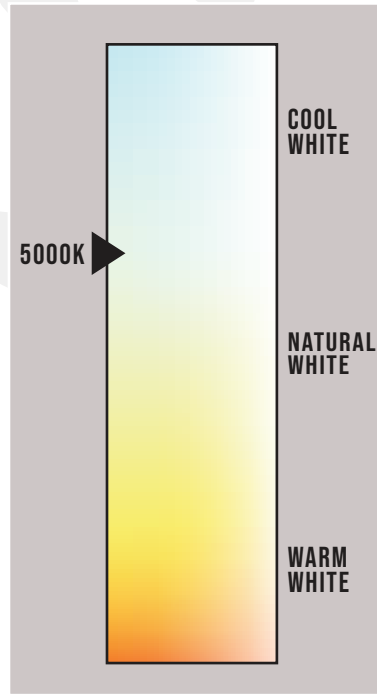

Dimensions

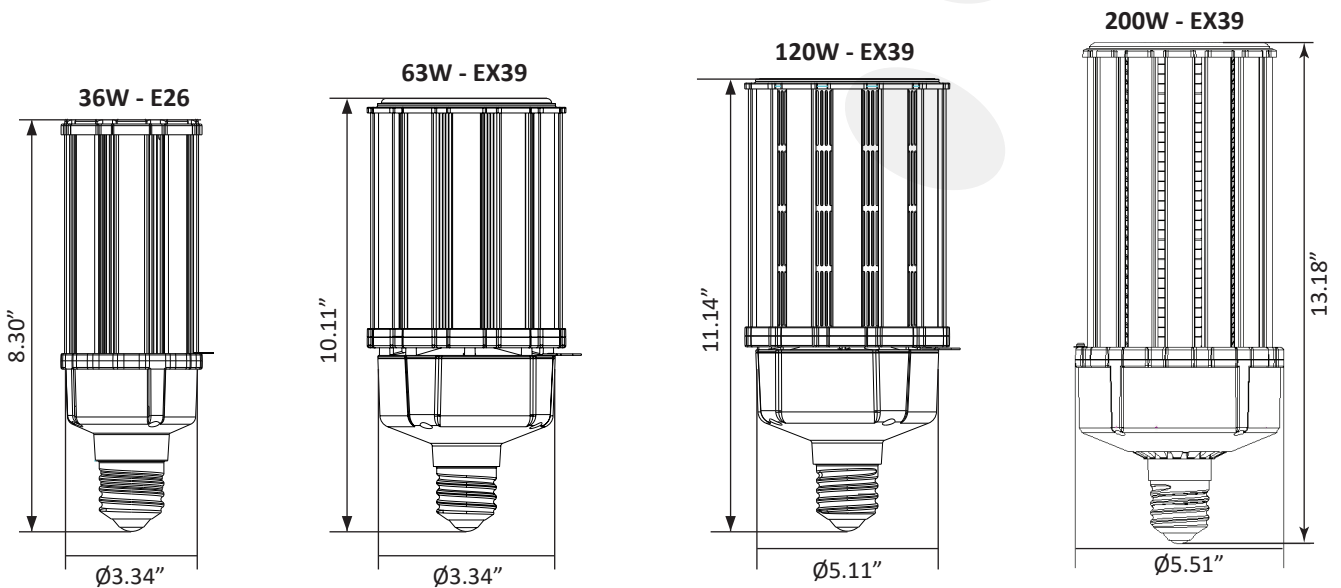

CROSS™

LED Corncob Bulb



SKU number 153464 Light Distribution Testing Parameters

Luminaire Data

Voltage: 120.0 V
 Current: 0.289 A
 Watt: 34.09 W
 Power Factor: 0.98

Photometric Results

IES Classification: Type I
 Total Rated Lamp Lumens: 4249.1 lm
 Efficiency: 100%
 Upward Ratio: 25%
 C0r0 Intensity: 116.17 cd

Longitudinal Classification: Short
 Measurement Flux: 4249.1 lm
 Downward Ratio: 75%
 Luminaire Efficacy Rating (LER): 124.69
 Max. Intensity: 766.58 cd

Luminous Intensity Distribution Curve

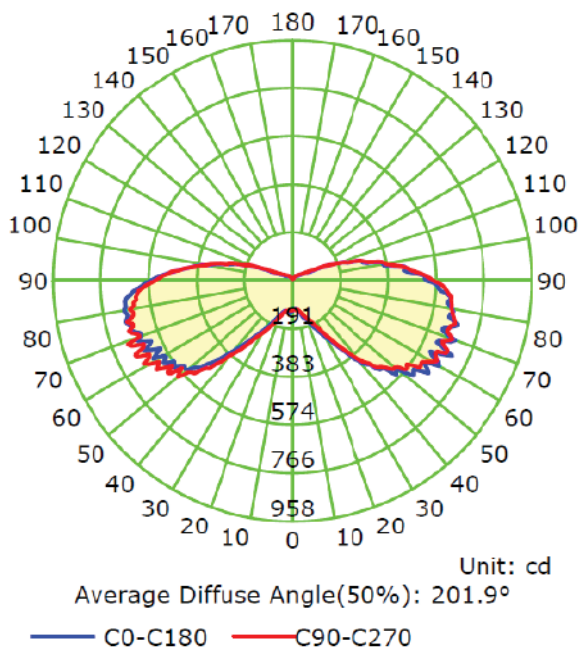

The Average Illuminance Effective Figur

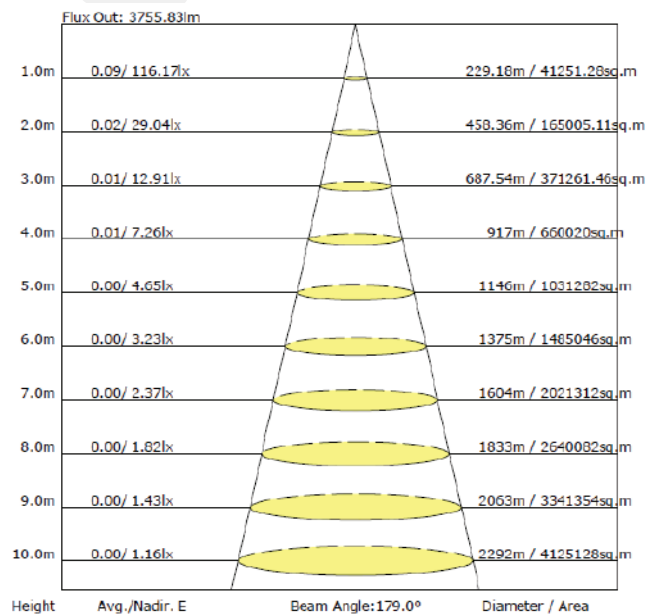



CROSS™ LED CornCob Bulb

SKU number 153465 Light Distribution Testing Parameters

Luminaire Data

Voltage: 120.0 V
Current: 0.53 A
Watt: 62.92 W
Power Factor: 0.99

Photometric Results

IES Classification: Type I
Total Rated Lamp Lumens: 7700.3 lm
Efficiency: 100%
Upward Ratio: 19%
C0r0 Intensity: 253.75 cd

Longitudinal Classification: Short
Measurement Flux: 7700.3 lm
Downward Ratio: 81%
Luminaire Efficacy Rating (LER): 122.43
Max. Intensity: 1555.56 cd

Luminous Intensity Distribution Curve

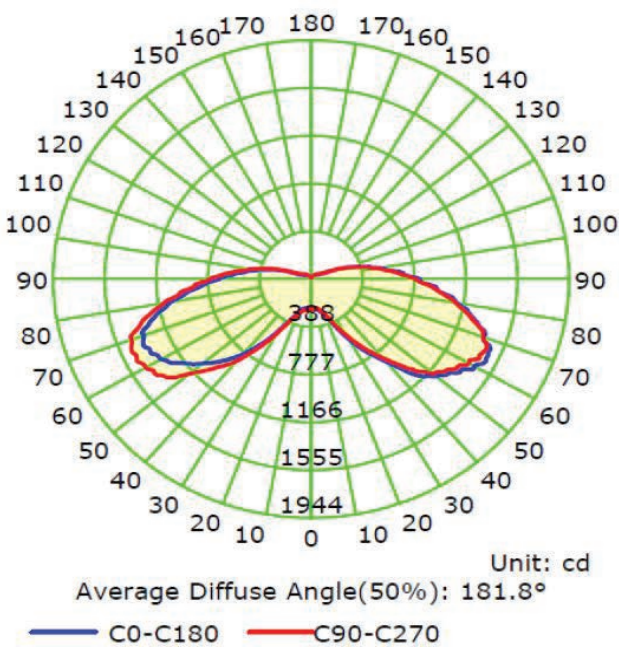

The Average Illuminance Effective Figure

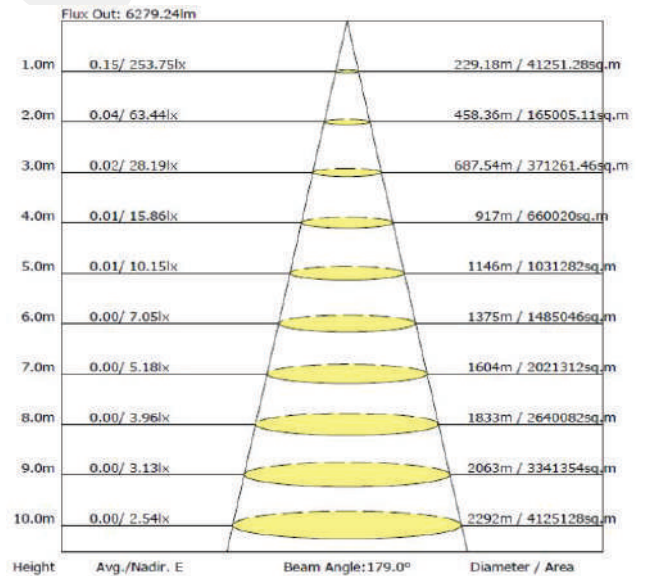

CROSS™

LED Corncob Bulb



SKU Number 153466 Light Distribution Testing Parameters

Luminaire Data

Voltage: 120.0 V
 Current: 1.02 A
 Watt: 121.21 W
 Power Factor: 0.99

Photometric Results

CIE Class: Direct
 Measurement Flux: 14835.9 lm
 Downward Ratio: 97%

Total Rated Lamp Lumens: 14835.9
 Efficiency: 100%
 Upward Ratio: 3%

Field Angle(C0/C180,C90/C270,C45/C225,C135/315): 191.3,191.4,191.9,190.7
 Beam Angle(C0/C180,C90/C270,C45/C225,C135/315): 146.9, 148.3, 148.1, 145.7
 Luminaire Efficacy Rating (LER): 122.45 C0r0 Intensity: 1442.33 cd

Luminous Intensity Distribution Curve

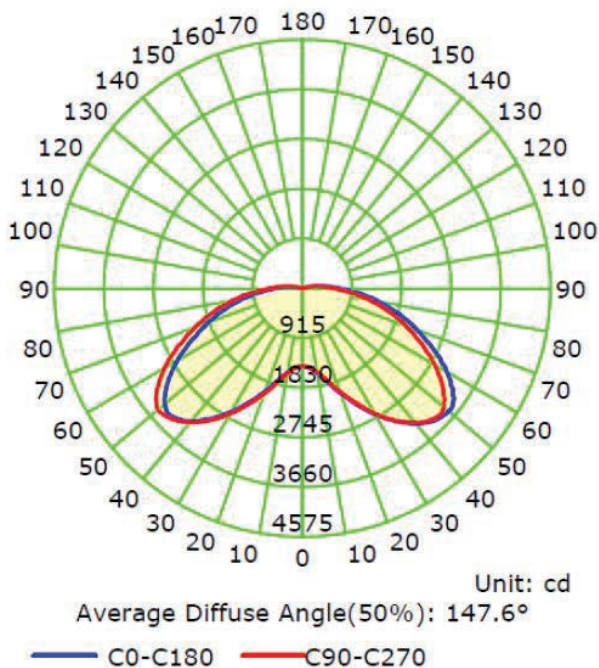

The Average Illuminance Effective Figure

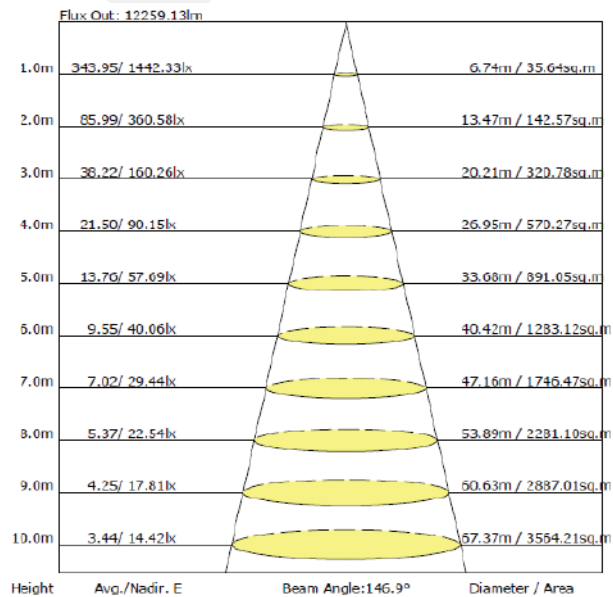



CROSS™ LED CornCob Bulb

SKU Number 156239 Light Distribution Testing Parameters

Luminaire Manufacturer:
Luminaire Category:
Lamp of Catalog:
Number of Lamps:
Luminous Length (mm):
Luminous Height (mm):
Current: 1.693 A
Power Factor: 0.996

Luminaire Description:
Lamp Description:
Lumens per Lamp:
Luminous Width (mm):
Voltage: 120.0 V
Power: 202.30 W

Photometric Results

IES Classification: Type III
Total Rated Lamp Lumens: 24332.6 lm
Efficiency: 100%
Upward Ratio: 5%
C0r0 Intensity: 3608.75 cd
Pos of Max. Intensity: H225 V40
Beam Angle(C0/C180,C90/C270,C45/C225,C135/315): 138.6, 139.3, 138.5, 139.0

Longitudinal Classification: Very Short
Measurement Flux: 24332.6 lm
Downward Ratio: 95%
Luminaire Efficacy Rating (LER): 120.33
Max. Intensity: 6045.01 cd

Luminous Intensity Distribution Curve

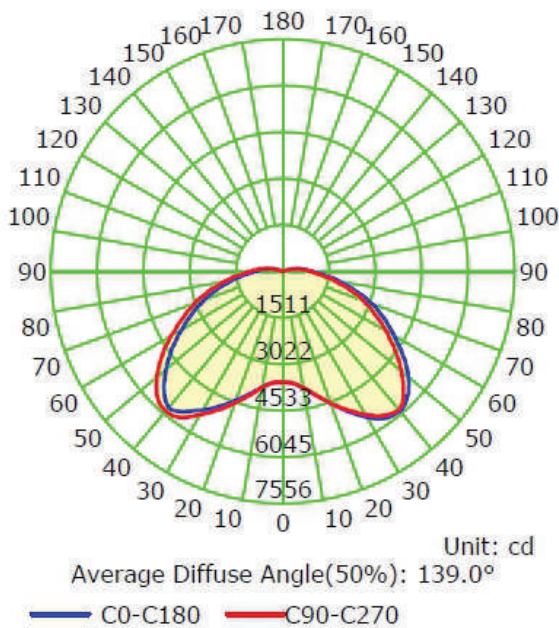

The Average Illuminance Effective Figure

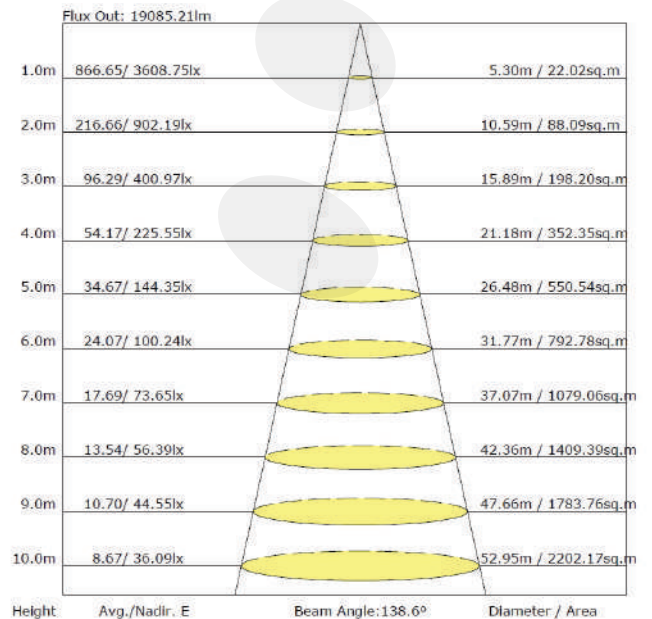

CROSS™

LED Corncob Bulb



Installation

LED Corn Light Instruction



Can not use the electric generator to test the LED lamp. Please avoid using the led fixture in environment where there is smoke, sulfur, and corrosive substances. But if used in such environment, make sure the led fixture is well protected by an enclosed lampshade whose dimension is no less than below size, and whose material is either glass or semi-glass, semi-metallic. Surface of the lampshade shall not have any covering which prevents heat dissipation.

Watt	18W	27W	36W	45/54W	63/80W
Volume (IN)	12.60x7.48 x7.48	13.38x7.87x7.87	15 x7.87x7.87	16.53x8.26x8.26	16.53x9.05x9.05

Watt	100W	120W	150W	170W	200W
Volume (IN)	17.32x9.45x9.45	17.32x10.23x10.23	11.81x11.81x18.50	11.81x11.81x18.50	11.81x11.81x18.50

LED CORNCOB BULB



CROSS™ LED Corncob Bulb

Installation Instructions

Warning: Please make sure the power is off before installation.

1. Turn off the power switch.
2. Screw off the CFL or MHL or HPS and so on, see Figure (5)(6).
3. Take out led corn light and screw on, see Figure (1)(2)(3)(4). Figure (1)(2) (3) (4):AC internal driver, (Note: Pls make sure to take off the ballast before installing led corn light, otherwise the ballast will produce the resonance of high voltage and makes led corn light breakdown.)
- 4.If security rope provided, pls fix the rope on the lamp with hand, then fix the wire of other end on the shell, see Figure(2) (4).
5. Turn on the power switch.(Finished!)

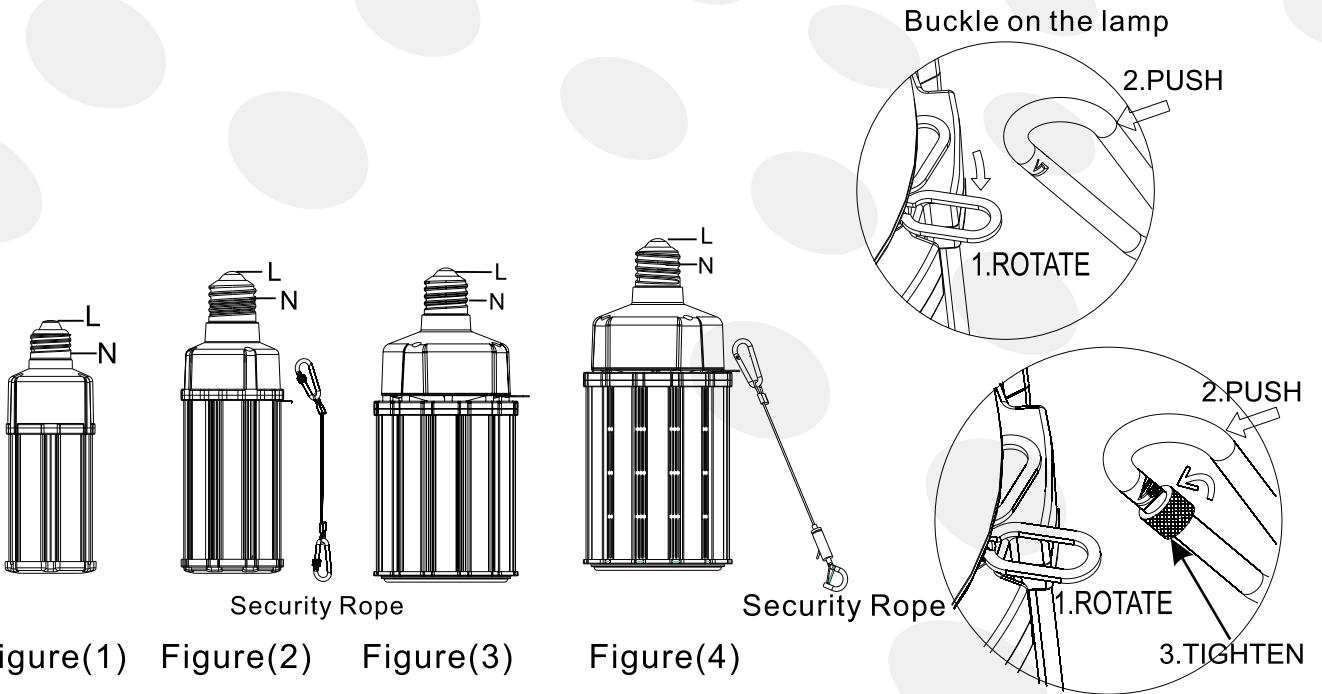

Figure(1) Figure(2) Figure(3) Figure(4)

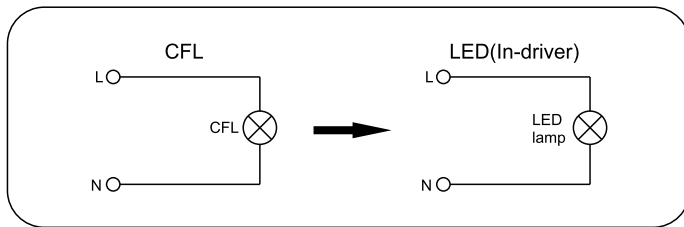

Figure(6)

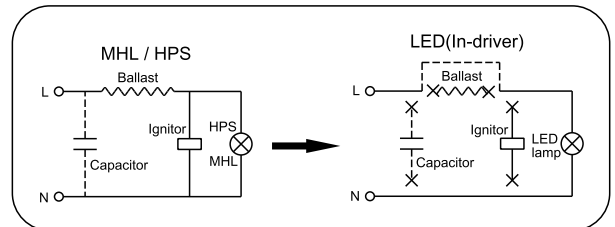

Figure(7)

CROSS™

LED Corncob Bulb



Wattage Adjustable

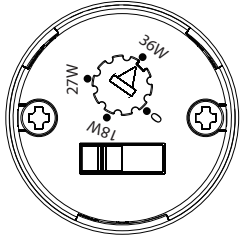

Wattage Adjustable
18W / 27W / 36W

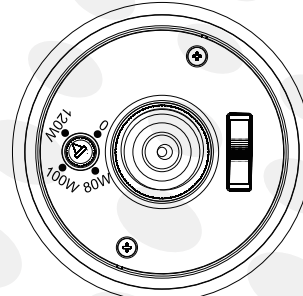

Wattage Adj. 80W / 100W / 120W

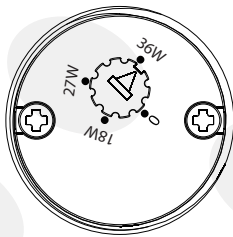

CCT 5000K
Wattage Adj.
27W-63W

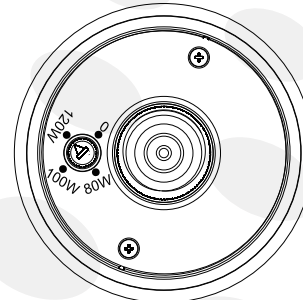

Wattage Adj.
80-120W

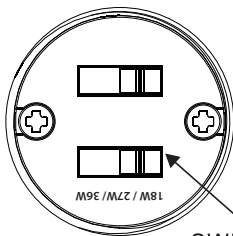

SWITCH

Wattage Adj.
18W / 27W / 36W

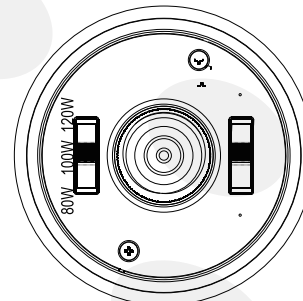

Wattage Adj.
80W-120W

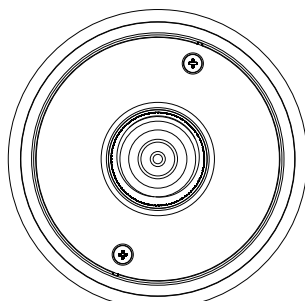

Wattage Adj.
80W-120W

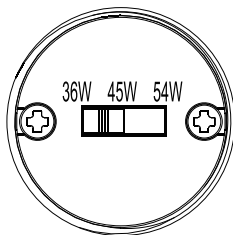

Wattage Adj. 36W-54W

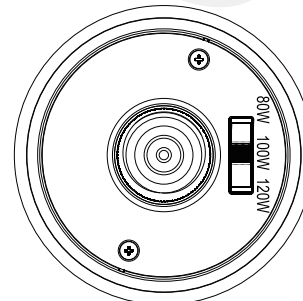

Wattage Adj. 80W-120W

Figure(8)

LED CORNCOB BULB



CROSS™

LED Corncob Bulb

Installation

WARNING:

WARNING — Risk of fire or electric shock. LED Retrofit Kit installation requires knowledge of luminaires electrical systems. If not qualified, do not attempt installation. Contact a qualified electrician.

WARNING — Risk of fire or electric shock. Install this kit only in the luminaires that have the construction features and dimensions shown in the photographs and/or drawings and where the input rating of the retrofit kit does not exceed the input rating of the luminaire.

WARNING — To prevent wiring damage or abrasion, do not expose wiring to edges of sheet metal or other sharp objects. Do not make or alter any open holes in an enclosure of wiring or electrical components during kit installation.

THE RETROFIT KIT IS ACCEPTED AS A COMPONENT OF A LUMINAIRE WHERE THE SUITABILITY OF THE COMBINATION SHALL BE DETERMINED BY AUTHORITIES HAVING JURISDICTION. PRODUCT MUST BE INSTALLED BY A QUALIFIED ELECTRICIAN IN ACCORDANCE WITH THE APPLICABLE AND APPROPRIATE ELECTRICAL CODES. THE INSTALLATION GUIDE DOES NOT SUPERSEDE LOCAL OR NATIONAL REGULATIONS FOR ELECTRICAL INSTALLATIONS. SUITABLE FOR DAMP LOCATIONS.

ADDED WEIGHT OF THE DEVICE MAY CAUSE INSTABILITY OF A FREE STANDING PORTABLE LUMINAIRE. USE ONLY WITH A PORTABLE TABLE LAMP THAT IS PROVIDED WITH A SHADE. USE IN PORTABLE TABLE LAMPS IN WHICH THE DISTANCE FROM THE BOTTOM OF THE BASE TO THE TOP OF THE LAMP HOLDER DOES NOT EXCEED THREE (3) TIMES THE MINIMUM BASE DIAMETER.

THIS DEVICE IS NOT INTENDED FOR USE WITH EMERGENCY EXITS" or "NOT FOR EMERGENCY LIGHTING. MIN. LAMP COMPARTMENT DIMENSIONS (L x W x H)

CROSS™

LED Corncob Bulb



Packaging

For SKU number 153464

	Size (Inches)	Qty	Net Weight (LBS)	Gross Weight (LBS)
Inner Box	3.54x3.54x9.65	1PC	1.23	1.56
Outer Box	14.96x11.42x10.43	12PC	14.99	20.94

For SKU number 153465

	Size (Inches)	Qty	Net Weight (LBS)	Gross Weight (LBS)
Inner Box	3.54x3.54x11.60	1PC	1.54	1.98
Outer Box	14.96x11.42x12.40	12PC	17.42	24.91

For SKU number 156239

	Size (Inches)	Qty	Net Weight (LBS)	Gross Weight (LBS)
Inner Box	5.70 x 5.70 x 14.37	1PC	3.48	4
Outer Box	17.71 x 12 x 15.15	6PC	21	25.35

For SKU number 156768

	Size (Inches)	Qty	Net Weight (LBS)	Gross Weight (LBS)
Inner Box	5.31 x 5.31 x 12.40	1PC	3.42	3.64
Outer Box	16.53 x 11.22 x 13.19	6PC	21.16	24.03

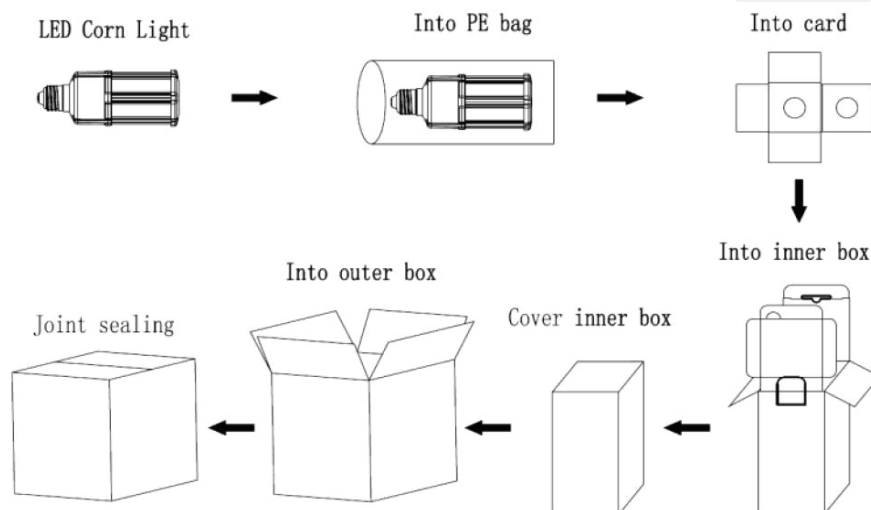



CROSS™

LED Corncob Bulb

Application

Replacement Lamps for Outdoor Pole/Arm-mounted Decorative Luminaires (Type B). Widely used in supermarket, warehouse, garage, home, office, hotel, hospital, school, street, garden etc.



CROSS™

LED Corncob Bulb



Application



LED CORNCOB BULB



CROSS™

LED Corncob Bulb

Safety Precautions

To reduce the risk of death, personal injury or property damage from fire, electric shock, falling parts, cuts/abrasions, and other hazards read all warnings and instructions included with and on the fixture box and all fixture labels.

Before installing, servicing, or performing routine maintenance upon this equipment, follow these general precautions.

Commercial installation, service and maintenance of luminaires should be performed by a qualified licensed electrician.

For the installation: If you are unsure about the installation or maintenance of the luminaires, consult a qualified licensed electrician and check your local electrical code. To prevent wiring damage or abrasion, do not expose wiring to edges of sheet metal or other sharp objects. Do not make or alter any open holes in an enclosure of wiring or electrical components during kit installation.

WARNING: RISK OF FIRE OR ELECTRICAL SHOCK

Turn off electrical power at fuse or circuit breaker box before wiring fixture to the power supply. Turn off the power when you perform any maintenance. Verify that supply voltage is correct by comparing it with the luminaire label information. Make all electrical and grounded connections in accordance with the National Electrical Code and any applicable local code requirements. All wiring connections should be capped with UL approved wire connectors.

CAUTION: RISK OF INJURY

Avoid direct eye exposure to the light source while it is on.

Account for small parts and destroy packing material, as these may be hazardous to children.

Warranty

5 Years Warranty.