



BOISE™

2nd Gen



Beyond LED's Boise 2nd Gen Landscaping lights are the best solutions to replace HID lamps. Superior performance and robust design make this product suitable for any general purpose landscape lighting application such as garden, signage and accent lighting in heavy commercial and residential applications. Its great for lighting flags, monuments, steeples and bridges.

Product Features

- Up to 135 Lumens per watt
- CCT Adjustable
- Input Voltage 120-277Vac
- Ground Stake mounting
- Beam Angle 85° Degree
- Die-cast aluminum housing
- Good heat dissipation and anti-corrosion
- Optical-grade PC lampshade
- IP65 Rated
- Transparent polycarbonate optical lens
- Strict waterproof and dustproof treatment for dry or wet locations
- Instant start, NO flickering, NO humming
- UL & DLC Listed
- 5 Year warranty

BOISE™

2nd Gen



SKU #	Model #	Watt	Lumens	CCT	Mount	Housing	Input Voltage	Certifications
155667	BLT-FL17-13WBH5DA1-BR30/40/50	13W	1820Lm	3K/4K/5K	Ground Stake & Knuckle Mount	Bronze	120-277V	UL & DLC
155668	BLT-FL17-25WBH5DA1-BR30/40/50	25W	3375Lm	3K/4K/5K		Bronze	120-277V	UL & DLC

SKU #. 155667 Specifications

Parameter	Description	
General Performance	Model #	BLT-FL17-13WBH5DA1-BR30/40/50
	Wattage	13W
	Lumens	1820Lm
	Lumen Efficacy	Up to 135LM/W
	Color Temperature	3000K/4000K/5000K
	CRI (Ra)	>80
	Distribution Pattern	5H5V
Electrical	Beam Angle	(50% Tolerance)45° Degree / (10% Tolerance)85° Degree
	Input Voltage	120-277Vac
	Frequency	50/60Hz
	Dimming	0-10V
	Power Factor	≥0.9
	Flicker Percent	<55%
	Driver Brand	HBE
	Driver Model	Beyond LED Technology
Driver Surge Protection	L/N-PE: 4kV, L-N: 4kV	
Physical	Operating Temperature	-40°C TO 45°C
	Operating Humidity	20% - 90% RH
	Storage Temperature	-40°C TO 80°C
	Storage Humidity	10% - 95% RH
	LED Brand	Lumileds
	LED Type	2835
	LED Qty.	56PCS
	Housing	Die-cast aluminum
Housing Color	Bronze	
Qualification	IP Rating	IP65
	Warranty	5 Year



BOISE™

2nd Gen

SKU #. 155668

Specifications

Parameter	Description	
General Performance	Model #	BLT-FL17-25WBH5DA1-BR30/40/50
	Wattage	25W
	Lumens	3375Lm
	Lumen Efficacy	Up to 135LM/W
	Color Temperature	3000K/4000K/5000K
	CRI (Ra)	>80
	Distribution Pattern	5H5V
Electrical	Beam Angle	(50% Tolerance)45° Degree / (10% Tolerance)85° Degree
	Input Voltage	120-277Vac
	Frequency	50/60Hz
	Dimming	0-10V
	Power Factor	≥0.9
	Flicker Percent	<55%
	Driver Brand	HBE
	Driver Model	Beyond LED Technology
Physical	Driver Surge Protection	L/N-PE: 4kV, L-N: 4kV
	Operating Temperature	-40°C TO 45°C
	Operating Humidity	20% - 90% RH
	Storage Temperature	-40°C TO 80°C
	Storage Humidity	10% - 95% RH
	LED Brand	Lumileds
	LED Type	2835
	LED Qty.	84PCS
	Housing	Die-cast aluminum
Qualification	Housing Color	Bronze
	IP Rating	IP65
	Warranty	5 Year

BOISE™

2nd Gen



Correlated Color Temperature (CCT)

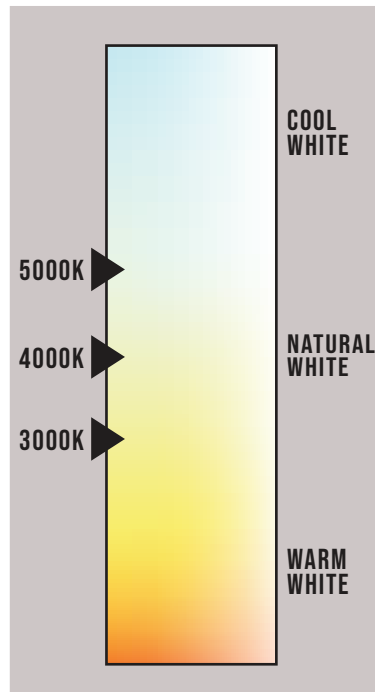

Dimension

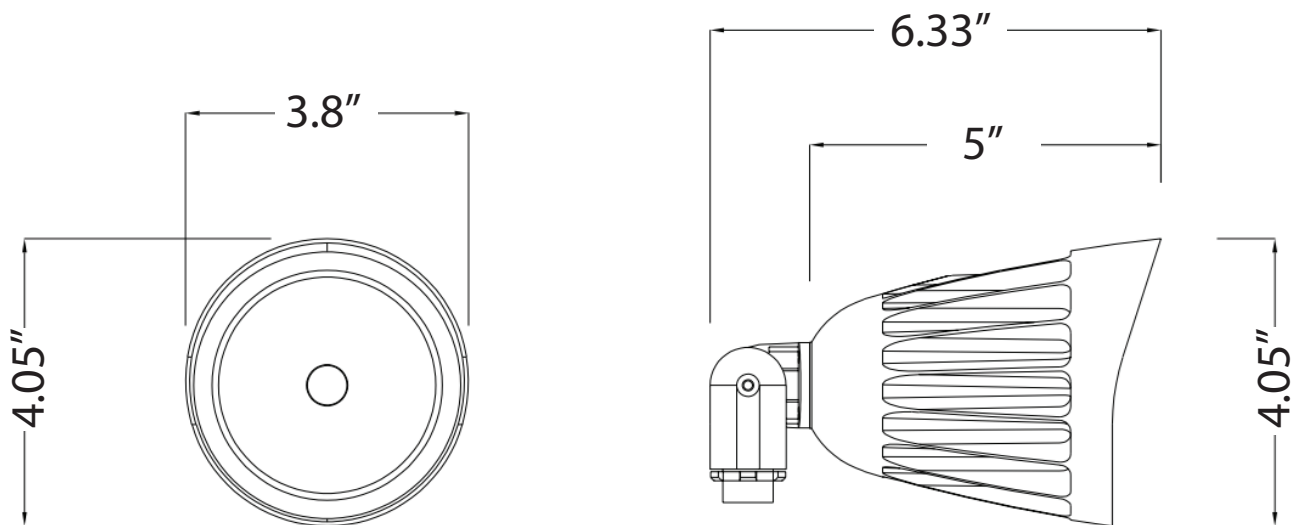



BOISE™

2nd Gen

Luminaire Property (SKU: 155667)

Photometric Results

CIE Class: Direct	Total Rated Lamp Lumens: 1863.9 lm
Measurement Flux: 1863.9 lm	Efficiency: 100%
Downward Ratio: 99%	Upward Ratio: 1%
Horizontal Diffuse Angle(10%,50%): H84.2,H39.4	Central Intensity: 2783.4 cd
Vertical Diffuse Angle(10%,50%): V83.6,V39.6	Pos of Max. Intensity: H112.5 V2
Luminaire Efficacy Rating (LER): 150.37	S/MH(C90/C270): 0.63
Max. Intensity: 2819.07 cd	
S/MH(C0/C180): 0.62	

Luminous Intensity Distribution Curve

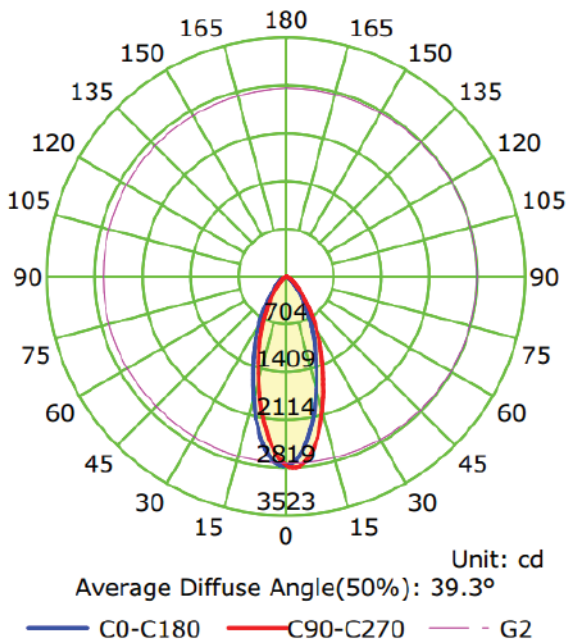

Illuminance at a Distance(Beam Angle)

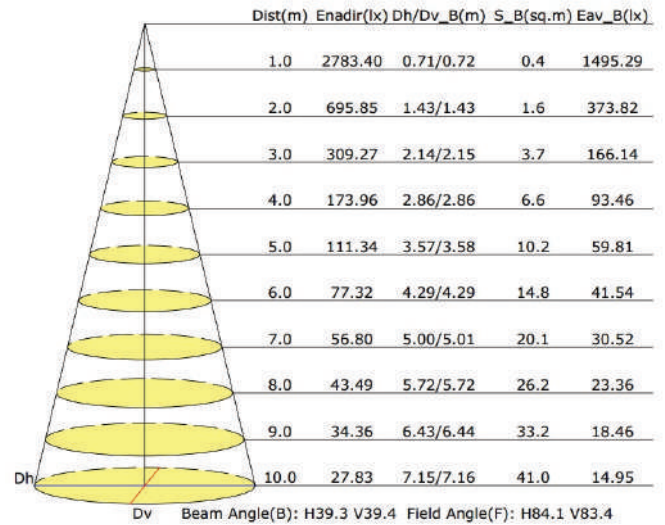



Luminaire Property (SKU: 155668)

Photometric Results

IES Classification: Type I
 Total Rated Lamp Lumens: 3418.2 lm
 Efficiency: 100%
 Upward Ratio: 1%
 Central Intensity: 4482.44 cd
 Pos of Max. Intensity: H315 V4

Longitudinal Classification: Very Short
 Measurement Flux: 3418.2 lm
 Downward Ratio: 99%
 Luminaire Efficacy Rating (LER): 145.08
 Max. Intensity: 4605.43 cd

Luminous Intensity Distribution Curve

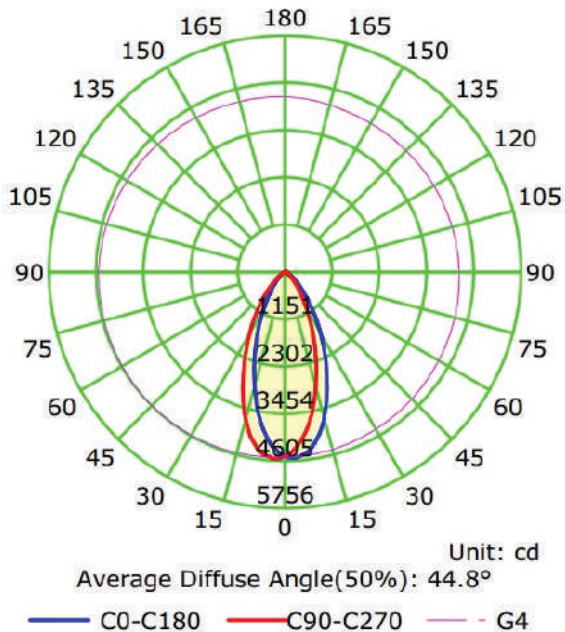

Illuminance at a Distance(Beam Angle)

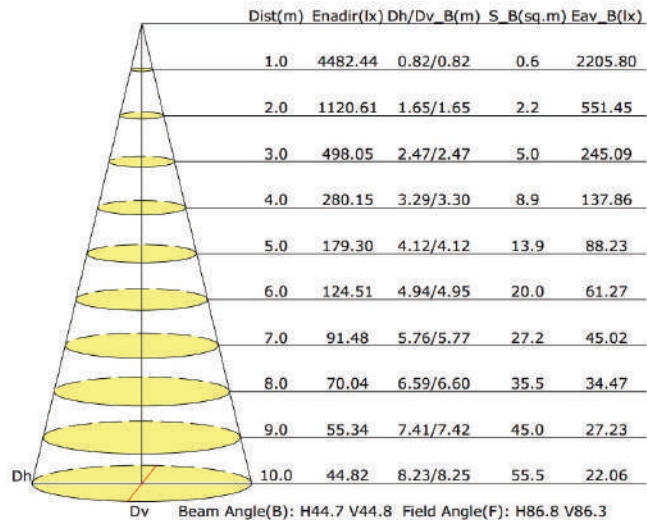



BOISE™

2nd Gen

Installation

Cautions:

1. Can not use the electric generator to test the LED lamp.
2. Please abide by related country, regional and local law and regulations when install this fixture.
3. To avoid electrical shock and damage, please do not install the lights in raining days.
4. Please turn off the power before installation or maintenance. Proper grounding is required to ensure safety.

Notices:

1. To prevent from electric shock or fire risk, installation must be conducted by operator with professional electrical knowledge.
2. Please wear gloves to avoid injury before installing lamps.
3. During or after installation, if there are situations such as smoke, fire in the wires or lamps, please turn off the power immediately and notify relevant personnel for an overhaul.
4. This light can be used for outdoor installation.

Instructions:

1. Adjustable color temperature.
2. This product has dimming function.
3. 2 dimming functions are available for this LED lamp.
 - (1) Constant current can be achieved by 0-10VDC dimming.
 - (2) Variation of resistance unit dimming (Please choose the appropriate dimming way according to your needs. You can also choose not to use this function.
4. Choose the wire connection ways, dimming ways and installation ways according to your needs.

Wiring Diagram:

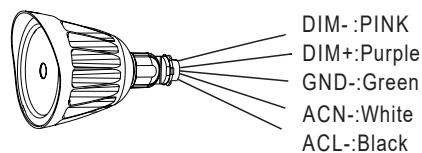

1/2 ADJUSTABLE FITTER MOUNTING (1/2AM)

- Step 1: Take the lamp out of package (Figure1);
- Step 2: Finish wire connection according to the right mode of connection (pay attention to positive wire, negative wire, and ground wire), and then put wire into lamp pole (Figure2);
- Step 3: Loosen screws; adjust fixture angle as per actual demands and tighten screws later; Tips:Angle of the fixture is adjustable (Figure3);
- (pass the bracket through mounting surface, fix it with screws, then connect the wires as per proper wiring requirements.) (Figure4)



Installation

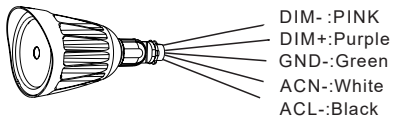

(Figure1)

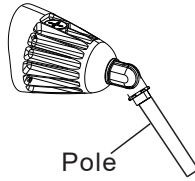

(Figure2)

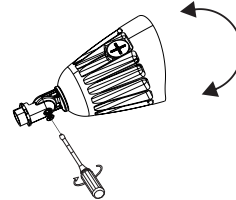

(Figure3)

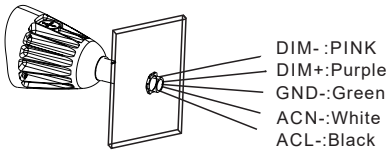

(Figure4)

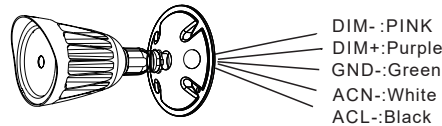

(Figure5)

1/2 ADJUSTABLE FITTER MOUNTING (1/2AM)

Step 1: Take the lamp out of package (Figure1);

Step 2: Finish wire connection according to the right mode of connection (pay attention to positive wire, negative wire, and ground wire), and then put wire into lamp pole (Figure2);

Step 3: Loosen screws; adjust fixture angle as per actual demands and tighten screws later; Tips: Angle of the fixture is adjustable (Figure3);

(pass the bracket through mounting surface, fix it with screws, then connect the wires as per proper wiring requirements.)

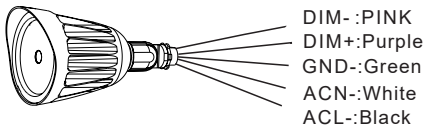

(Figure1)

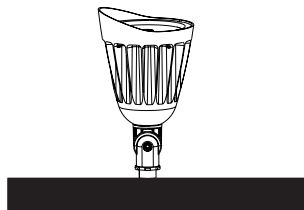

(Figure2)

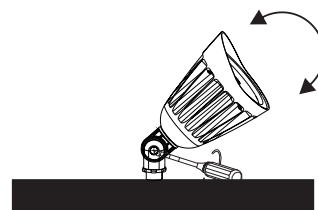

(Figure3)

Function adjustment

Function adjustment

Step 1: Open the metal plug and with a screwdriver (figure1), Then slide the switch left and right to adjust the CCT controller, Adjust the color temperature as required (figure2).

Step 2: After adjusting the required control function, tighten the metal plug (figure3).

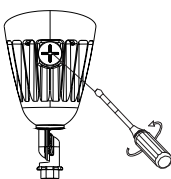

(Figure1)

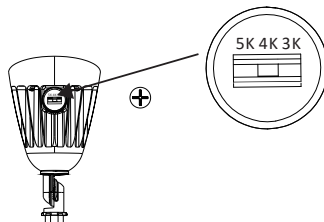

(Figure2)

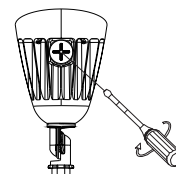

(Figure3)



BOISE™

2nd Gen

Notice For User

- Please turn off power before install or change assembly parts.
- The input voltage and lamps should be matched, after connecting the power line, Please make sure the wiring section is insulated.
- Non-professionals, must not install and disassemble the lamps.

Trouble Shootings

Trouble	Check Points
Flickering of the light	Turn off the power and turn on again in 3 minutes. If same phenomena occur, then call agencies.
Out of working	Please check the connection.

Package

SKU #	Carton Size	Qty/Carton	Net Weight	Gross Weight
155667	17.28 x 13.11 x 7.36	12PCS	11.64 LBS	18.65 LBS
155668	23.15 x 17.28 x 10.55	12PCS	11.64 LBS	18.65 LBS

Warranty

5 Years Warranty



Application Images

