

Rev	Date
A	01 / 09 / 2023

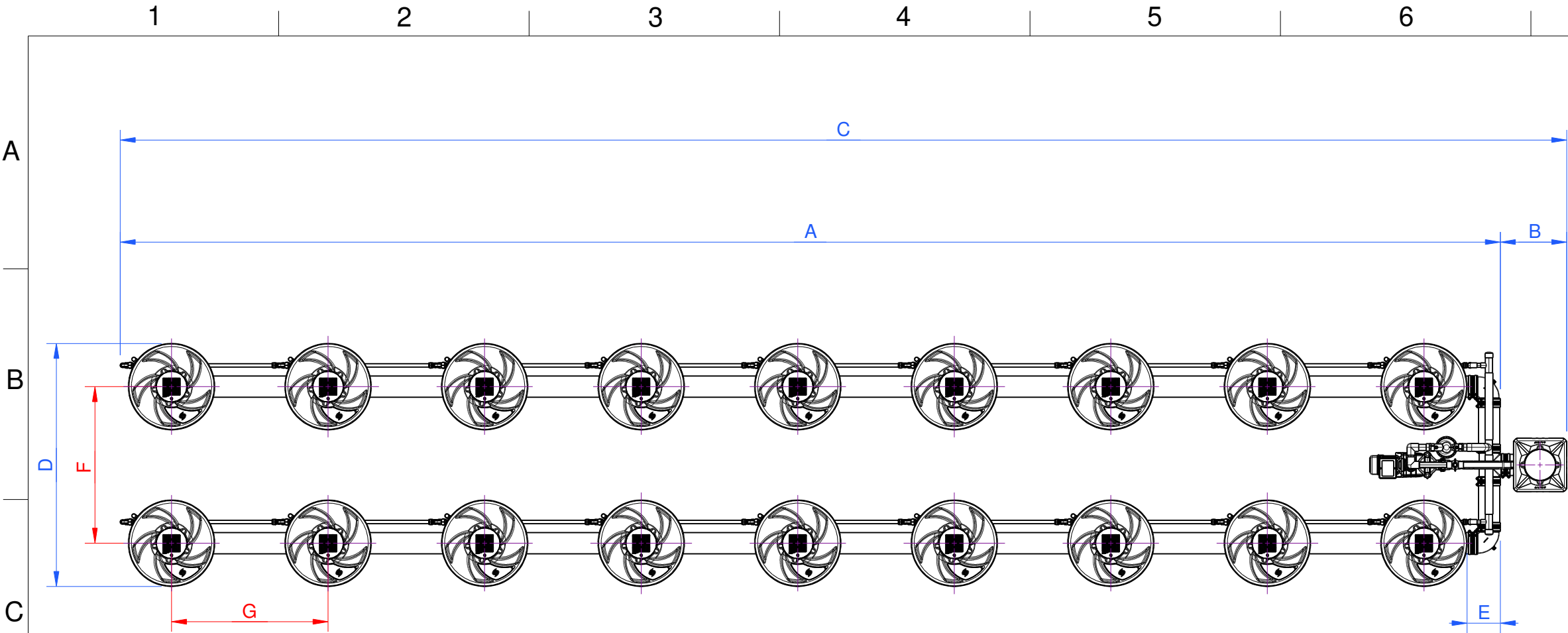

Inverted Header:

The header can be located inside the footprint as shown.

This option reduces overall length of system to dimension "A" (please refer to dimensions table).

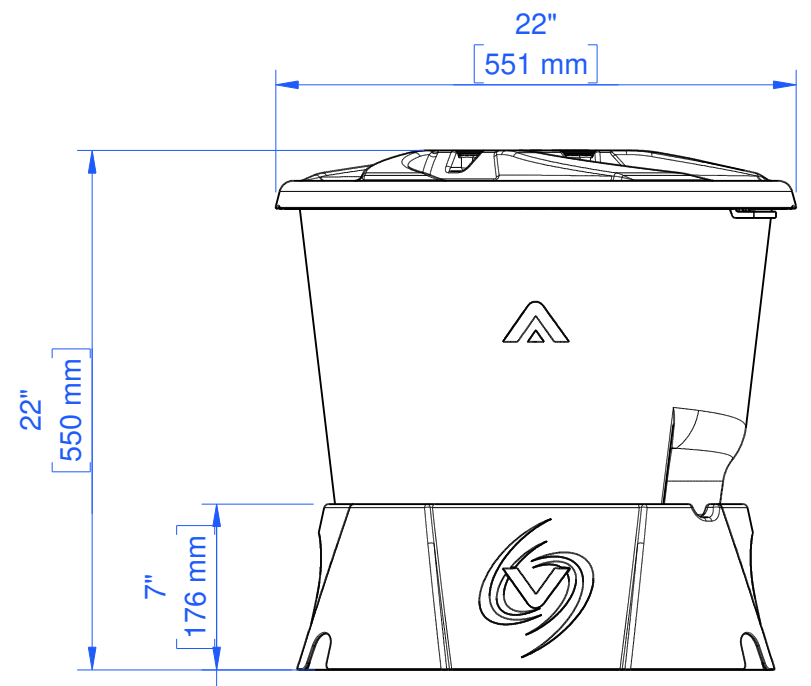
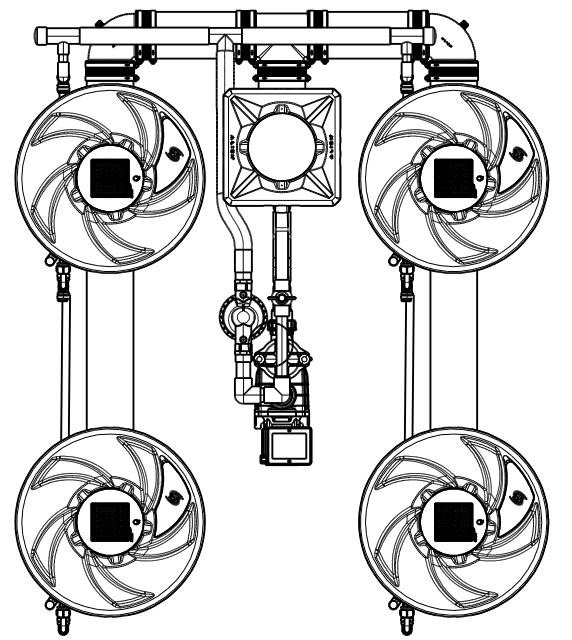

Dimensions	Minimum	Maximum @ 40" / 1m Plant Centers*
A	204" (5180mm)	347" (8820mm)
B	17" (420mm)	42" (1070mm)
C	220" (5600mm)	364" (9240mm)
D	48" (1200mm)	61" (1550mm)
E	8" (210mm)	8" (210mm)
F	26" (650mm)	40" (1000mm)
G	23" (580mm)	40" (1000mm)

*** Note:**
Plant centers greater than 40" / 1m are possible with custom order lengths of 5" tubing, please contact sales@alienhydro.com for more details.

	Project: V-SYSTEM	Scale 1 : 32
	Title: 2 Row 18 Pot	
	Drawing Number: V-2.18_US	Sheet 1 of 1