

SAMSUNG

LM301H Diodes

OSRAM

660NM Diodes

KS5000

USER INSTRUCTIONS

Contact Us:

- Follow us on Facebook @ViparSpectra
- Sending an email to support@viparspectra.com
- Contact us via Amazon or eBay message.
- www.viparspectra.com

SAFETY INFORMATION

Dear Users,

Thank you for choosing our products! Please read this instruction carefully before using your lights.

1. CAUTION: Do not look directly at the LED bulbs when the lighting equipment is working.

2. The maximum temperature of the installed environment (ambient temperature) will ensure the safe operation of the lighting equipment. So you will need to control the temperature within the installed environment. (Example: mechanical ventilation or cooling system is required to maintain the temperature within the growing space below 104°F (or 40°C) when the lighting equipment is in operation).

3. Instructions to guide the installation such that cords:

- Are not concealed or extended through a wall, floor, ceiling, or other parts of the building structure,
- Are not located above a suspended ceiling or dropped ceiling,
- Are not permanently affixed to the building structure,
- Are routed so that they are not subject to strain and are protected from physical damage,
- Are visible over their entire length, and
- Are used within their rated ampacity as determined for the maximum temperature of the installed environment specified in the instructions.

4. This lighting equipment is for indoor use only. Not water-proof, protect your lighting equipment from dampness, dust, and water.

5. CAUTION: For horticultural lighting structures, installation shall be performed by qualified personnel and that the structures are intended for installation subject to approval by the authority having jurisdiction.

6. Set up your light in the operating environment that allows for adequate air circulation. Never push objects into the ventilation openings.

7. When cleaning the outside of your light and its components, first, you need to shut off your light, then unplug the power cord. Using a clean, soft, lint-free cloth to wipe the light. Avoid getting moisture in any openings.

8. CAUTION: Possibly hazardous optical radiation emitted from this product. Do not stare at the operating lamp. May be harmful to the eyes.

KS5000

KS5000 SPECIFICATION

Model	KS5000	HID Replacement	1000W HPS/MH
Feature	Dimmable	Vegetative Coverage at 28"	4.0 × 4.0 ft
Actual Power Draw	500W±3% at 120V	Flowering Coverage at 16"	4.0 × 4.0 ft
LEDs	SAMSUNG LM301H 3000K, 5000K OSRAM 660NM	Use for	all stages grow and flowering
Total Harmonic Distortion	< 15%	Housing Dimensions	40 × 40 × 1.6 inches
Input	AC100-240V~4.6A	Item Weight	12.8 lbs
Frequency	50/60Hz	Lifespan	≥ 100,000 hours

PLANTING SUGGESTIONS

($\mu\text{mol}/\text{m}^2/\text{s}$)

Species	Seed	Vegetative Cutting	Vegetative	Flower/Fruit/Reproductiv
Canna Plants	200-400	75-150	400-600	600-1000 (No CO ₂)
Tomatoes	150-350	75-150	350-600	600+
Cucumbers	100-300	-	300-600	600+
Peppers	150-350	-	300-600	600+

Seedlings - You will need to hang the light high due to the delicate nature of seedlings. We recommend a break-in period of about a week while a seed has broken the surface. The first set of real leaves should be present while the seedling has been above ground for about a week.

Clones - Clones are a little bit hardier than fresh seedlings, but still, need to be given gentle light as they are entirely rootless when first cut, and need to conserve energy and moisture to transition into a rooting stage.

Vegetative - The deeper red spectrum is utilized less by the plant than when it is in flower. It uses high levels of white light that are essential for creating lush, thick plants that have tight internodal spacing and minimal stretching.

Flowering - The plant has much work to do and is performing many complex biological processes in producing flowers and fruits. Because of this, the plant now requires large amounts of light.

Late Flower - Most rapid development has stopped, and the plant is gearing up for the scene in which the large flowers and fruits will mature or ripen.

If you expose plants to high light intensities too early in the crop cycle, you can damage chlorophyll pigments causing photo-oxidation (photo-bleaching), so we recommend slowly increasing your light intensity as your plant develops.

KS5000 PPF MAP

Tested in a 4.0 x 4.0 ft Grow Tent

Seedling: **50%**

Distance: **30" (77cm)**

324	350	358	368	369	362	353	335
347	360	377	384	382	371	357	356
353	371	391	397	393	380	365	369
357	381	397	403	398	384	372	372
366	384	399	403	398	386	370	367
361	380	394	397	390	379	363	355
336	362	379	379	375	363	353	325
326	327	347	350	359	357	332	321

4ft

Vegetative Stage: **75%**

Distance: **28" (70cm)**

464	510	530	546	541	529	511	480
498	525	560	573	566	550	523	513
503	540	577	589	583	565	534	536
509	560	591	601	593	573	550	542
520	561	591	602	591	570	542	530
515	550	584	591	581	559	535	516
484	529	560	565	551	530	520	490
468	501	513	532	530	520	500	460

4ft

Flowering Stage: **100%**

Distance: **16" (40cm)**

619	743	806	821	824	800	733	638
693	838	945	963	940	898	818	717
697	870	977	994	971	934	845	707
703	863	969	1000	1000	985	963	924
723	873	978	992	967	925	833	705
741	895	996	1000	1000	999	976	928
685	845	923	939	917	864	810	682
620	720	785	801	816	750	721	618

Usable PPE: **2.40 µmol/J**

Hanging Height:	16" (40cm)
MAX PPFD:	1000 µmol/m²/s
Power Draw:	500W
Ave. PPFD:	833 µmol/m²/s
Usable PPF:	1200 µmol/s
Usable PPE:	2.40 µmol/J

Visit our website for more useful suggestions and PPFD Maps.

USING SUGGESTIONS

KS5000	Seedlings / Clones / Mother Plants	Vegetative Stage	Flowering Stage
Brightness	50%	75%	100%
Power Draw	250 Watts	375 Watts	500 Watts
Hanging Height (Above Plant)	30" (77cm)	28" (70cm)	16" (40cm)
Maximum PPFD	403 µmol/m²/s	602 µmol/m²/s	1000 µmol/m²/s
Average PPFD	367 µmol/m²/s	540 µmol/m²/s	833 µmol/m²/s
Using Hours	18 on / 6 off	18 on / 6 off	12 on / 12 off

MOUNTING INSTRUCTIONS

1. Mounting

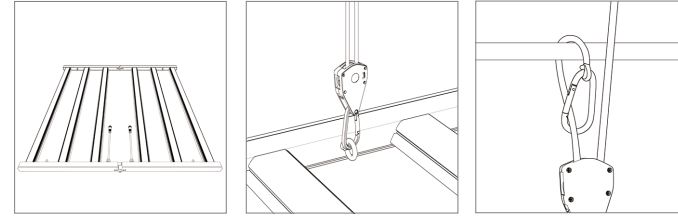

1. Unfold your light fixture and place it on the floor with the LEDs facing downward.

2. Attach the rope ratchets to each hanging hole on the light.

4. Hang up each rope ratchets in a safety mounting location and raise them to the desired hanging height.

KS5000 Product suspension diagram

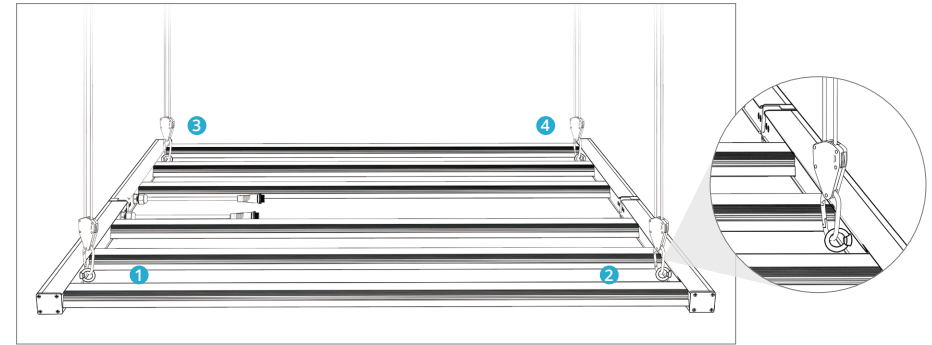

Option 1 (Recommended)

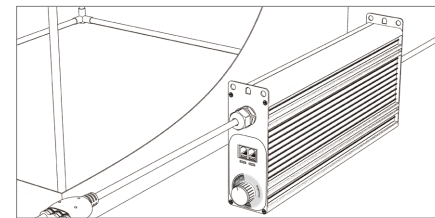

Place the LED driver in a safety location outside the grow tent.

Option 2

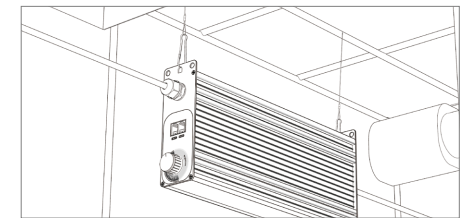

Hang up the LED driver in a safety location in the grow tent.

* Light housing's temps would become higher after working several hours. Do not touch the operating lamp.

* SUITABLE FOR OPERATION IN AMBIENT NOT EXCEEDING 104°F (or 40°C).

MOUNTING INSTRUCTIONS

3. Connect LED Driver to Light(s)

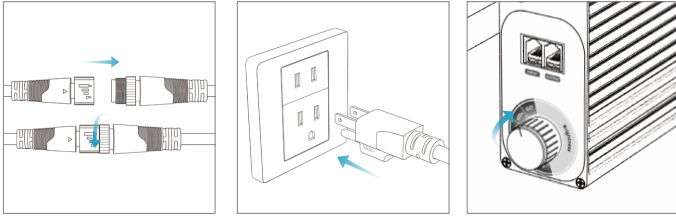

1. Connect the driver power cord to the light. To remove the connection, twist the locking ring counter clockwise and pull.
2. Plug the light into an outlet.
3. Adjust the brightness based on your desired light intensity needs.

4. Connecting Multiple Fixtures

- (1) Connect Output on the first driver to Input on the next driver in the lighting system chain.
- (2) Repeat until all drivers are connected.
- (3) Adjust to EXT on all drivers except the first driver.
- (4) All fixtures in the chain are controlled by the first driver.

* You can connect unlimited fixtures.

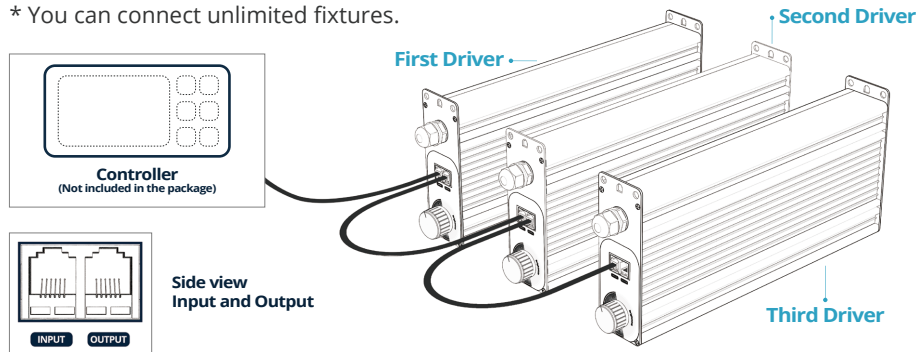

5. Use with a Controller

KS enables integration with most third-party 10V PWM controllers.

- (1) Connect Output on the Controller to Input on the first driver in the lighting system chain.
- (2) Repeat "4. Connecting Multiple Fixtures."

* Your controller decides how many products can be connected.

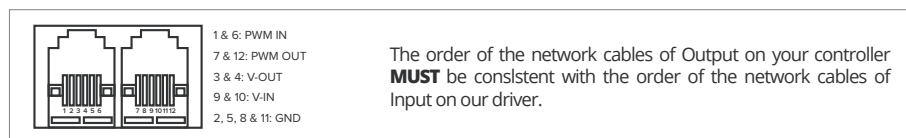

WARRANTY TERMS

1. This warranty applies only if you purchased your products in the United States.
2. We offer 3 years warranty for our KS Series LED grow lights purchased against manufacturing defects from the date of purchase. If you need any warranty assistance, please contact us as soon as possible.
3. The warranty does not cover damage due to high moisture levels, water, power surges, improper hanging or mounting, incorrectly use, dust build-up, or user modifications.
4. If your light has any quality issue within 30 days, please kindly contact us. We will email you a prepaid return label if the lights need to be returned to our warranty center. You can choose:



Replacement. Please send the light back to our warranty center. A new replacement will be shipped to you for free as soon as we receive the defective light.



Money-Back. Please send the light back to our warranty center. You will get your money back as soon as we receive the defective light.



Repairing. We can send the part immediately if it is missing part or accessory issue. Or you also can choose to return the light. We will send the light back to you after fixing it. It will not cost any repair charge — all for free.

5. Repairing. If any light has any quality issue over 30 days after delivery, please kindly contact us to get a satisfactory solution. We can send the part free of charge immediately if it is missing part or accessory issue. Or you also can choose to return the light with the provided prepaid shipping label. We will send the light back to you after fixing it — all for free.

6. For customers outside the US, you will also enjoy 3 years US warranty. Back and forth shipping cost from your country to our US warranty center would be buyer's responsibility. All repairs are only processed within the United States.

7. If a light was not covered under warranty, we might still be able to perform warranty service. However, that is at our discretion, and repair may bear a cost that will be assessed before repairing the light.

Our company reserves the interpretation right of this warranty structure. If you have any questions about our warranty policy, please kindly contact us.