

Master Controller
TSC-2

Spectrum-Y 

LED GROW LIGHT
USER MANUAL

IMPORTANT PRODUCT INFORMATION

- Please read this manual thoroughly before attempting to install or operate our LED products.
- After successful installation and configuration of the system, be sure to keep this manual in a safe place for future reference. Safety is a key component to a long-lasting and trouble-free installation.
- Use all our products only as directed. Failure to observe the following safety warnings may result in serious injury or death, and by law, will waive any and all liability for the manufacturer and resellers.

WARNINGS AND INSTRUCTIONS FOR USE:

- ⚠ **Warning:** To reduce the risk of electrical shock or serious injury, always take the proper precautions and unplug the fixture before moving or cleaning it.
- ⚠ **Warning:** In the event that the light bar becomes submerged, first disengage the circuit breaker, then unplug the fixture before removing it from the water.
- ⚠ **Warning:** Our LED grow lights are for indoor use only. Do not expose to water drip or spray. Do not expose the lights to physical harm such as impact or severe environmental conditions. The optimal operating temperature is between 68°F-86°F/20°C -30°C.
- ⚠ **Warning:** When installing our LED grow lights, ensure that the power outlets are properly grounded and have adequate capacity. If there is any doubt, please consult an electrician. Please ensure that there is adequate space for airflow around the lights. A minimum of 12 inches of space is recommended above the light and 2 inches at the sides.
- ⚠ **Warning:** To prevent eye damage, avoid looking directly at the lights when they are on. Use shielding or light-blocking glasses to protect your eyes.
- ⚠ **Warning:** Never place the fixture face down on a surface, as it may damage the diodes.
- ⚠ **Caution** LED and heat sink surfaces may be hot. Allow sufficient cooling time before handling.
- ⚠ **Caution** To reduce the risk of overheating, never place operating fixtures face down on a flat surface. Always allow for adequate ventilation of fixtures and power supplies.
- ⚠ **Recommendation:** We strongly encourage installing one or more surge suppressors to protect your grow light(s). Power surges are one of the leading causes of premature grow light failure.

OVERVIEW

Congratulations! You've just purchased the best full-spectrum LED grow light the industry has ever seen.

Our high-performance LED grow lights are up to 50% more power-efficient than HID technology.

Our light fixtures set a new standard for LED grow lighting. They are powerful enough to serve as the primary source of light in all indoor growing applications.

We strive to help you maximize your yields by offering the best lights that emit a full-spectrum, sufficient light intensity (PPFD) that covers your entire growing space.

Thank you for purchasing our products. We are sure you will be happy with the results they help you achieve.

CONTENTS

1. Package Contents
2. Installation Instructions (Wireless Control)
3. Installation Instructions (Wired Control)
4. Product Dimensions
5. Warranty Service

Package Contents

The package contains:

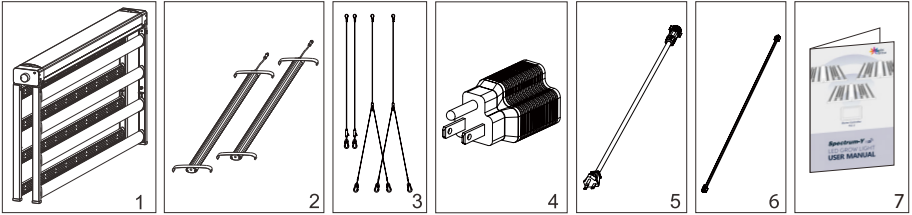

- | | |
|------------------|---------------|
| 1 LED Grow Light | 5 Power Cord |
| 2 UV/IR Bars | 6 RJ Cord |
| 3 Steel Cables | 7 User Manual |
| 4 Plug Adapter | |

Installation Instructions **Wireless Control**

Take caution when handling the light bars. Do not allow the LED diodes to come in contact with sharp objects that may damage them.

- 1 Unbox the light and place it on a flat surface. Make sure the surface is clear of objects that may damage LEDs.
- 2 Ensure the fixture is not plugged into the electrical power.
- 3 a. Press and hold to remove, lock, or adjust the steel cables.
b. Loop the steel cables around a secure structure and back to the adjuster.
c. Attach the carabiners of the hanging steel cables to the two hanging anchors.

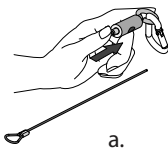
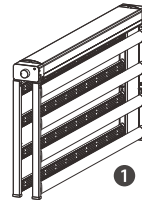

a.

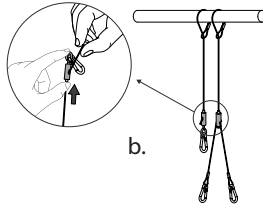

b.

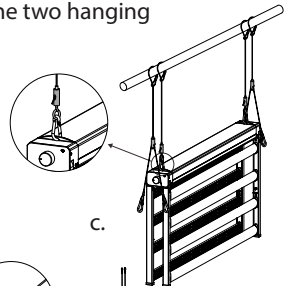

c.

- 4 Unfold the fixture and attach the carabiners of the longer steel cable to the hooks on each side. Adjust the cable by pressing the locking device.

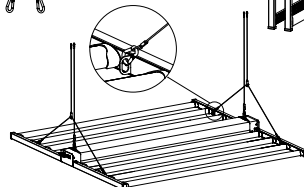

- 5 Mount the UV/IR bars and connect the power cords on the side bars.

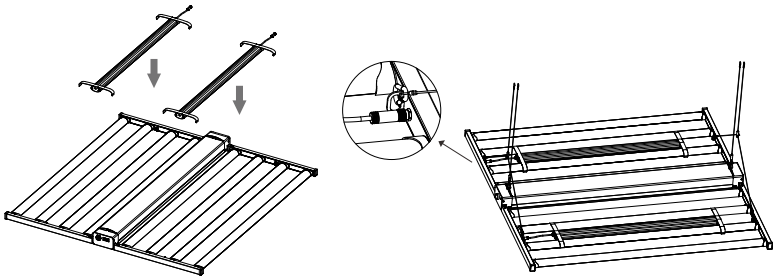

- 6 Connect the power cord to the light fixture and then plug it into a properly grounded power outlet.

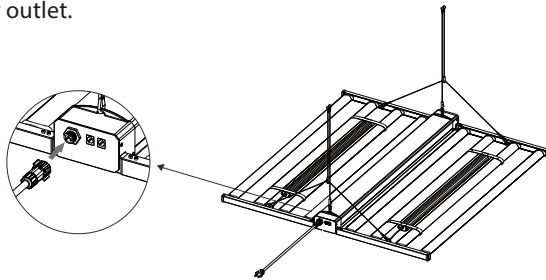

- 7 Switch the rotary knob on all fixtures to "EXT." Connect the controller to a power outlet.

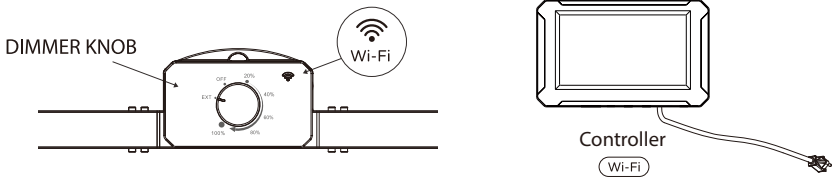

- 8 Set-up complete.

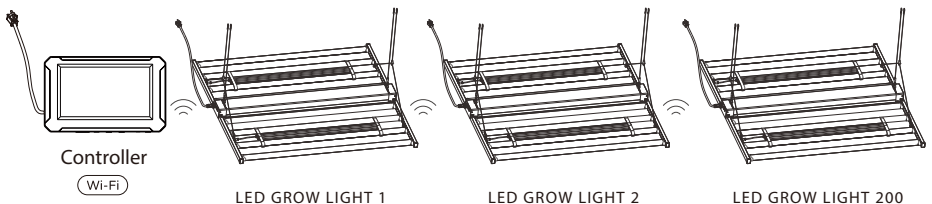

Installation Instructions **Wired Control**

Take caution when handling the light bars. Do not allow the LED diodes to come in contact with sharp objects that may damage them.

- 1 Unbox the light and place it on a flat surface. Make sure the surface is clear of objects that may damage LEDs.

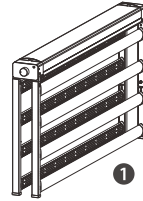

- 2 Ensure the fixture is not plugged into the electrical power.

- 3 a. Press and hold to remove, lock, or adjust the steel cables.
b. Loop the steel cables around a secure structure and back to the adjuster.
c. Attach the carabiners of the hanging steel cables to the two hanging anchors.

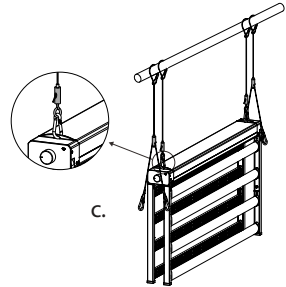
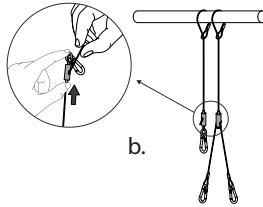
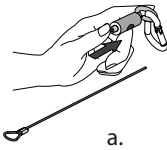

- 4 Unfold the fixture and attach the carabiners of the longer steel cable to the hooks on each side. Adjust the cable by pressing the locking device.

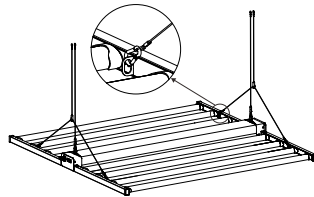

- 5 Mount the UV/IR bars and connect the power cords on the side bars.

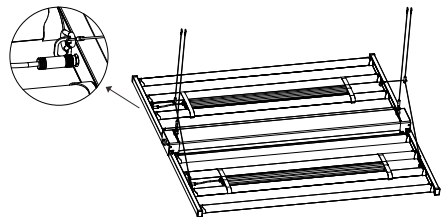
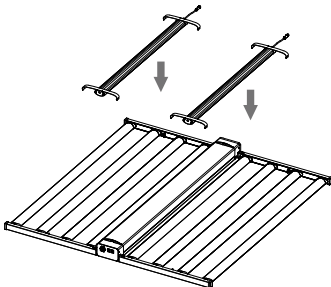

- 6 Connect one end of the RJ cord to the RJ port in the controller, and connect the other end of the RJ cord to the DIM IN port of the LED GROW LIGHT. Repeat the same action until you have wired all your fixtures.

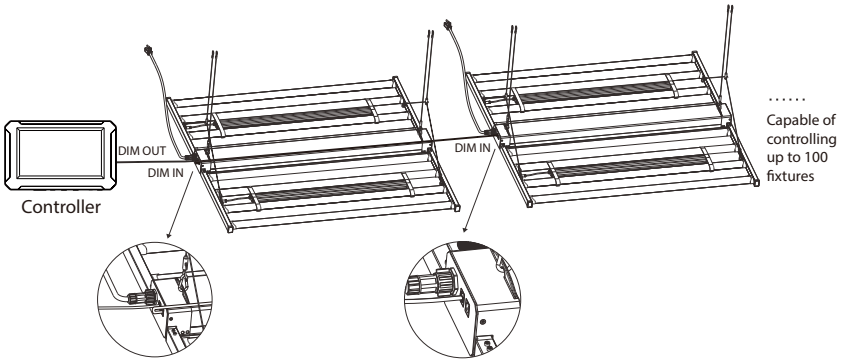

- 7 Switch the rotary knob on all fixtures to "EXT." Connect the controller to a power outlet.

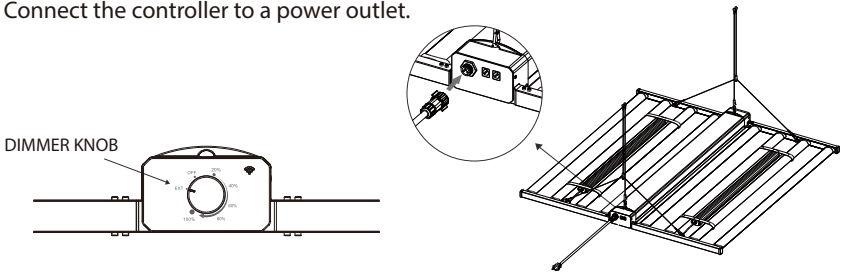

- 8 Connect the controller to the first or last fixture using the RJ cord. Connect the controller to a power outlet. Set-up complete.

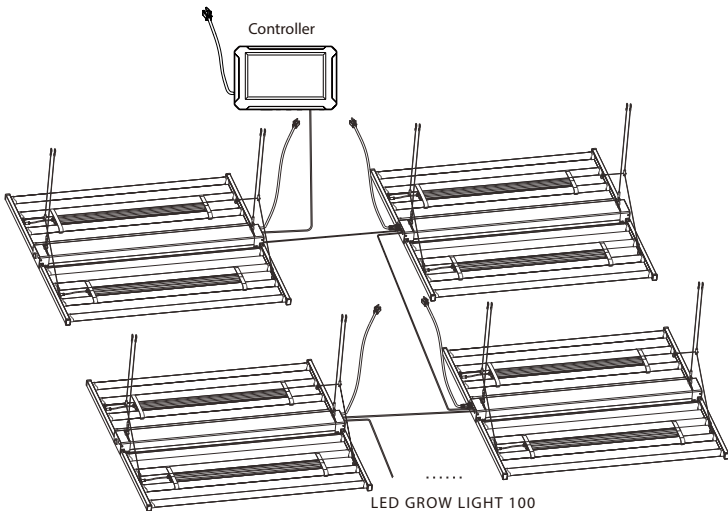

Product Dimensions

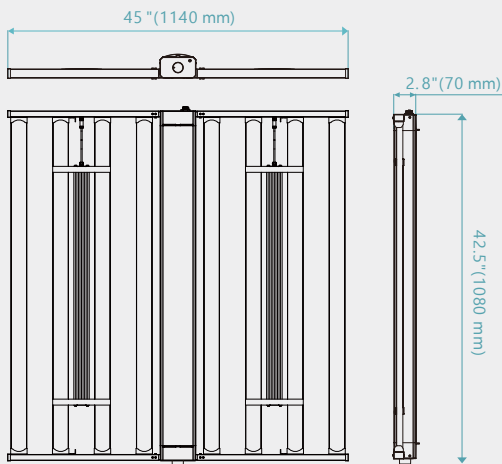

Warranty Service

If the product does not work after you have read the troubleshooting guide and practiced the troubleshooting options, please return the light to our warehouse or the retailer where you purchased it. The dealer will be able to examine the light and test its components. If they are not able to repair the light, they will return it to us for examination and repair/replacement. Do not attempt to repair any product on your own, as serious injury or death may result. If the retailer is not able to help you and the product is still under manufacturer's warranty, you may contact us for technical support.

If we commence a return process, please return the light with all its original packaging, and your receipt of purchase, to the address we will provide you in the email. Please pack and ship the product in its original packaging. If the light is damaged during shipment we cannot be responsible and the warranty may be voided. Once we receive your return package, we will repair or replace it and ship it back to you.

Thank you!