



USER GUIDE

V1.1



INTRODUCTION.....	3
SAFETY MESSAGE.....	3
DISCLAIMER.....	4
WARNING LABELS.....	4
SERVICE AND REPAIRS.....	6
WARRANTY.....	8
SAFETY PRECAUTIONS.....	9
COMPONENTS.....	10
EMERGENCY STOP (E-Stop).....	11
HMI CONTROL OVERVIEW.....	11
WASHING VESSEL TILT.....	15
DRAIN VALVES.....	17
SOAK WEIGHT.....	17
BAG HOLDER.....	17
SETUP.....	18
OPERATING CONDITIONS.....	18
UNCRATING THE MAKER™.....	19
ASSEMBLY / DISASSEMBLY.....	20
IMPELLER REMOVAL/INSTALLATION.....	20
FALSE BOTTOM REMOVAL.....	20
DRAIN VALVE(S) INSTALLATION / REMOVAL.....	20
WATER PUMP INSTALLATION/REMOVAL.....	21
THERMOMETER REMOVAL / INSTALLATION.....	23
WASH BAG HOLDER INSTALLATION.....	24
SOAK WEIGHT INSTALLATION.....	24
OPERATION.....	26
BEFORE YOU START.....	26
MACHINE START-UP SEQUENCE.....	26
MACHINE STOP SEQUENCE.....	27
WASHING PLANT MATERIAL.....	28

WASHING TIPS.....	31
PRE-LOADED SETTINGS.....	31
CLEANING YOUR MAKER™.....	32
HAND-CLEANING THE IMPELLER MOTOR AND WATER PUMP.....	33
HAND-CLEANING THE HMI.....	33
SERVICING YOUR MAKER™.....	33
SAFETY PRECAUTIONS.....	34
BREAKERS/FUSES.....	34
REMOVING OBSTRUCTIONS.....	34
MAINTENANCE SCHEDULE.....	35
TROUBLESHOOTING.....	37

INTRODUCTION

Congratulations on your selection of the Trinator Maker™ commercial hash washer! We want to help you to get the best results from your new hash washer and to operate it safely. This User Guide contains information on how to do that; please read it carefully before you set up and use your hash washer.

We suggest you read the [warranty](#) to fully understand coverage and your responsibilities of ownership. Keep this User Guide handy, so you can refer to it at any time. This User Guide is considered a permanent part of the Maker™ and should remain with the hash washer if resold. The information and specifications included in this publication are those that were in effect at the time of approval for printing. Eteros Technologies, (Eteros) reserves the right, however, to discontinue or change specifications or design at any time without notice and without incurring any obligation. No part of this publication may be reproduced without written permission.

SAFETY MESSAGE

To ensure operator safety while in use, this device includes decals, guarding, and other safety features. Operators are encouraged to use caution and best judgment when using the equipment. Equipment should be serviced when required.

To avoid possible damage to the machine and risk of injury to the operator, consult with an Eteros Technologies representative to answer any questions.

This document refers to the Eteros Technologies hash washing machine, the Maker™. Careless or improper use may cause serious injury. Please read and understand these precautions thoroughly before using the machine.

All operators must read and understand this User Guide and be trained in the safe operation and use of the Maker™ hash washer. We recommend the owner of this equipment develop a standard operating procedure (SOP) specific to each worksite to address any local hazards or other conditions not outlined in this User Guide. The Maker™ hash washer must be inspected regularly for damage, component failure, and wear. The results of the inspection activity should be documented.

Eteros Technologies makes every effort to ensure the Maker™ hash washer is compliant with all current safety standards. It is the responsibility of the owner to ensure all municipal, provincial, state, county, territorial, federal codes, regulations, and standards have been met in each working location.

Do not lend or rent your machine without providing the User Guide. A first-time operator should receive practical instruction before using the machine.

This machine is not to be used for any purpose other than those expressly stated in the User Guide, advertising literature, or other Eteros Technologies written material pertaining to the Maker™ hash washer.

Operators must be in good physical condition and mental health to operate this device. Under no circumstances should the device be operated by any person under the influence of any substance, including drugs or alcohol, which might impair vision, dexterity, or judgment. Do not operate the Maker™ hash washer when fatigued. Be alert. If tired while operating the device, take a break. Fatigue may result in loss of control. Working with any equipment can be strenuous. If you have any condition that might be aggravated by strenuous work, check with your doctor before operating the device.

DISCLAIMER

Eteros Technologies recognizes that the Maker™ hash washer is a purpose-built machine for processing cannabis by licensed producers. Please check all municipal, provincial/state, and federal laws and regulations before using the Maker™ hash washer. Eteros Technologies does not promote or condone the use of processing equipment in any way that may be deemed illegal.



Eteros Technologies recognizes that our equipment can be used for processing herbs, hops, flowers, and many other products. It is not the responsibility of Eteros Technologies to confirm alternative applications for our equipment.

WARNING LABELS

Your safety and the safety of others are very important. We have provided important safety messages in this manual and on the Triminitor Maker™. This information alerts you to potential hazards that could hurt you or others. Please read these messages carefully. Of course, it is not practical or possible to warn you about all the hazards associated with operating or maintaining a hash washer. You must use your own good judgment.

You will find important safety information in a variety of forms:

- **Safety Labels** - located on the hash washer.
- **Instructions** - how to use this hash washer correctly and safely.
- **Safety Messages** - preceded by a safety alert; a symbol and one of three signal words: DANGER, WARNING, or CAUTION.

	<p>DANGER:</p> <p>Indicates a hazardous situation that, if not avoided, will result in serious injury and/or death. This signal word is to be limited to the most extreme situations; typically for machine components that, for functional purposes, cannot be guarded.</p>
	<p>WARNING:</p> <p>Indicates a potentially hazardous situation that, if not avoided, could result in serious injury and/or death. It includes hazards that are exposed when guards are removed. It may also be used to alert against unsafe practices.</p>
	<p>CAUTION:</p> <p>Indicates a potentially hazardous situation that, if not avoided, may result in minor or moderate injury. It may also be used to alert against unsafe practices.</p>

Damage Prevention Messages - You will also see other important messages that are preceded by the word NOTICE. This word means:

NOTICE Your hash washer or other property can be damaged if you don't follow instructions.

SERVICE AND REPAIRS

Repairs may only be carried out by Eteros Technologies or a designated authorized agent (service technician).

Should the need arise, please notify us:

Eteros Technologies

**6175 South Sandhill Road, Unit 600,
Las Vegas, NV 89120**

www.eteros.com

www.thetriminator.com

service@thetriminator.com

(530) 265 4277

Improper interfacing, improper repair, or an unauthorized modification could result in void warranty claims.

WARRANTY

Thank you for your purchase of the Triminitor Maker™.

The Triminitor Maker™ is covered by our manufacturer's warranty as follows:

- No warranty on consumable parts, including micron bags;
- Warranty coverage for one (1) year or 1,000 operating hours, whichever occurs first, on motors, electrical components, and the remainder of machine components.

The warranty period begins on the date the equipment is received by the customer. Any damage that occurs during shipping will be the responsibility of Triminitor.

The above terms are valid if Triminitor equipment is used and maintained as directed. If the equipment is modified in any way, all terms of this warranty are void. This warranty does not apply to cosmetic damage, such as scratches or general wear and tear.

Should you experience a technical problem with your equipment, please contact Eteros Technologies at the email or phone number outlined in the [Service and Repairs](#) section.

SAFETY PRECAUTIONS

SAFETY INFORMATION

Read and become familiar with the entire User Guide. Learn the equipment applications, limitations, and possible hazards.

TRAINED WORKERS ONLY

KEEP CHILDREN and BYSTANDERS AWAY from the device. Visitors should be kept at a safe distance from the work area.

CHECK FOR DAMAGED PARTS PRIOR TO OPERATION

The equipment should be inspected prior to use to ensure proper operation in performing its intended function. Check for alignment of moving parts, binding of moving parts, breakage of parts, mounting, and any other conditions that may affect its operation. Any damaged part including guards should be properly repaired or replaced.

POWER DOWN AND DISCONNECT

Power down and disconnect equipment before servicing and when changing accessories, such as impeller, soak weight, and pump.

DON'T FORCE THE EQUIPMENT

It will operate optimally and safely at the rate for which it was designed.

USE THE RIGHT TOOL

Don't force the device to do a job for which it was not designed.

WORK IN A SAFE ENVIRONMENT

DO NOT USE THE DEVICE IN A DANGEROUS ENVIRONMENT or damp or wet locations. Never expose the control panel directly to rain or water. Keep the work area well-illuminated. DO NOT use the device in the presence of flammable liquids or gasses.

KEEP THE WORK AREA CLEAN

Cluttered areas and workspaces invite accidents.

COMPONENTS

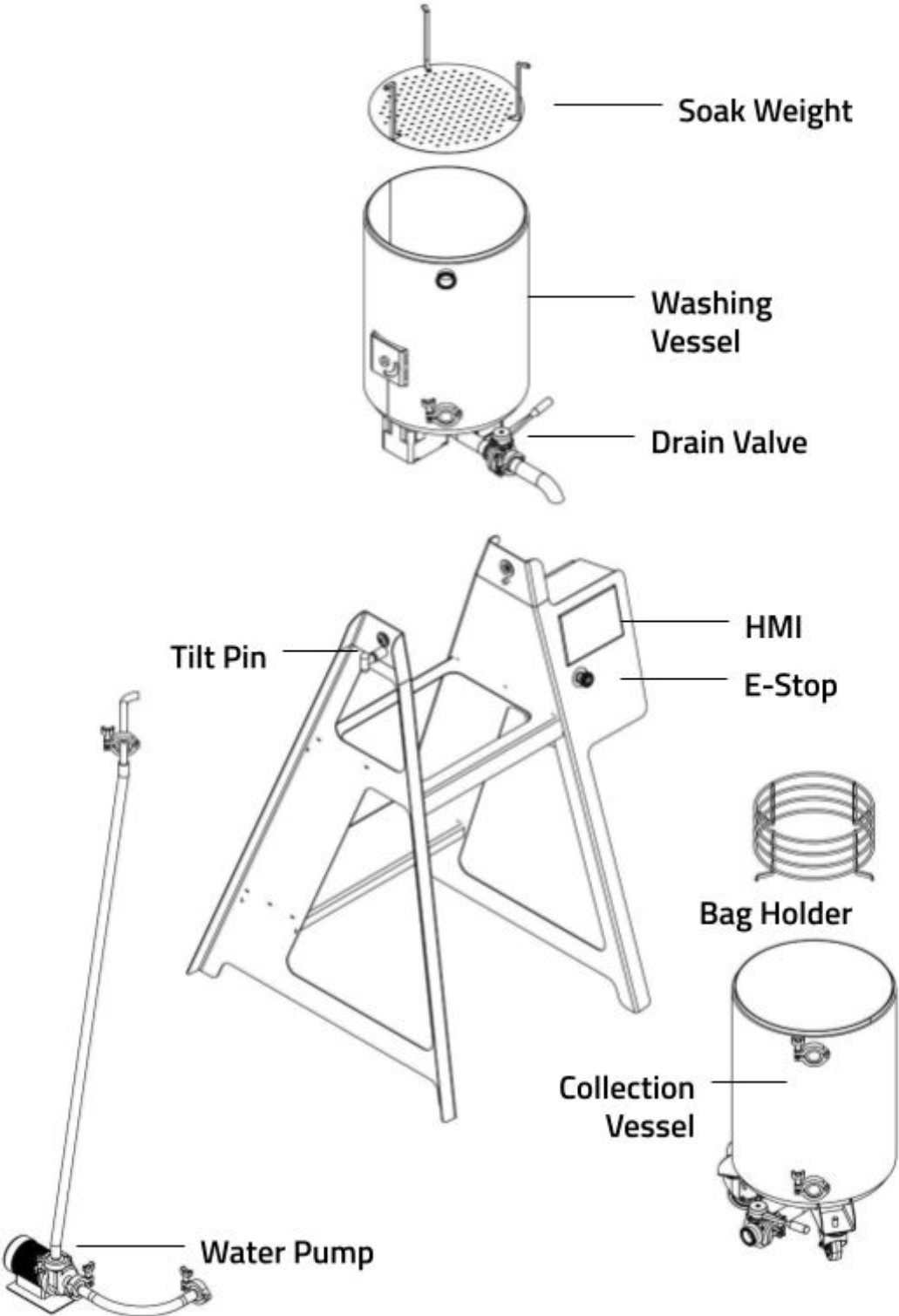

EMERGENCY STOP (E-Stop)

Pressing the emergency stop button will immediately shut down the machine, stopping the impeller and water pump. When the emergency stop button is depressed, a visual cue will be displayed on the HMI and the Maker™ will not run.

NOTICE It is NOT recommended to use the emergency stop button to stop the machine in everyday operation.

HMI CONTROL OVERVIEW

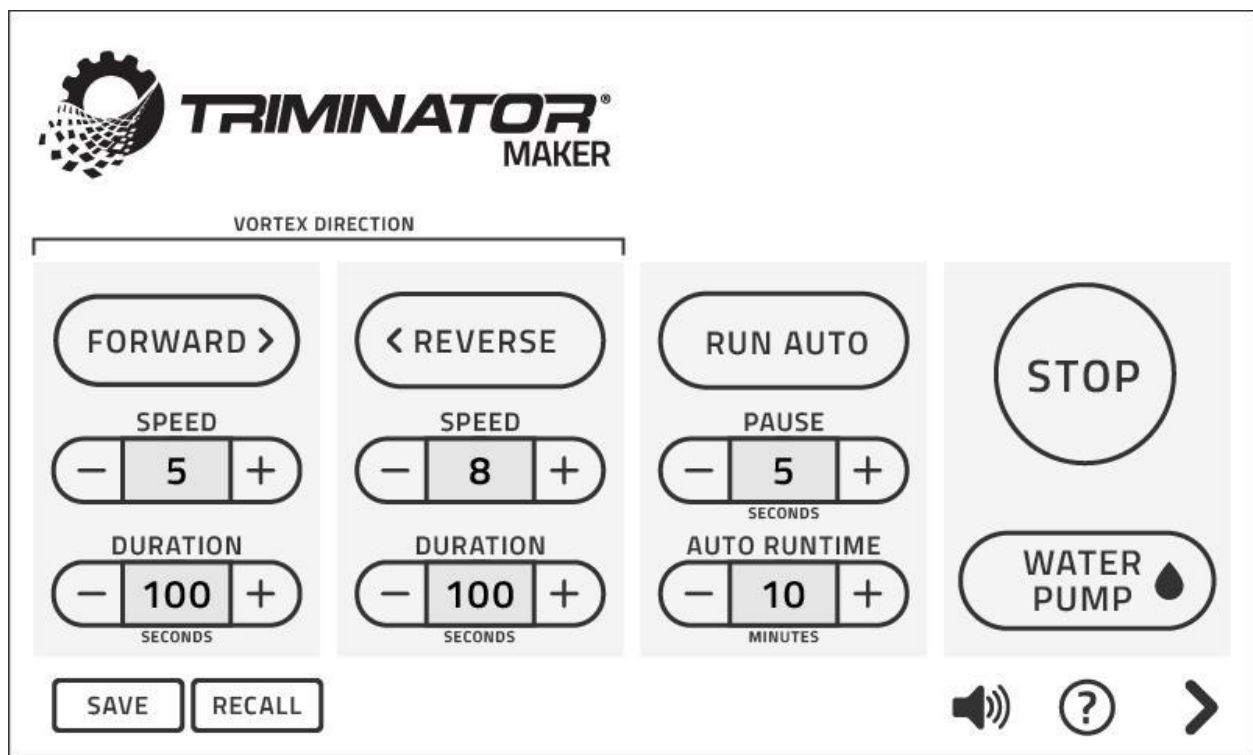

FORWARD

When selected, the unit will run in manual mode continuously at the set speed. Duration does not apply when running in manual mode. Speed can be adjusted while running and will take effect immediately. The FORWARD button will be highlighted in white with a red border when selected.

REVERSE

When selected, the unit will run in manual mode continuously at the set speed. Duration does not apply when running in manual mode. Speed can be adjusted while running and will take effect immediately. The REVERSE button will be highlighted in white with a red border when selected.

RUN CYCLE/AUTO

When RUN CYCLE is selected, the unit will run in auto mode. The cycle will alternate between forward and reverse at the set speed and duration (seconds) for both directions. Pause time (seconds) and duration (minutes) can be selected in the RUN CYCLE settings. Changes to duration and pause changes will take effect on the following cycle of forward or reverse. Auto runtime cannot be adjusted mid-cycle. The RUN CYCLE button will be highlighted in white with a red border and display AUTO when selected.

STOP

The START/STOP button acts as a master switch, toggling the Maker™ between the stop/standby and start/operational modes. Both modes allow for changes to the speed and duration settings. In operational mode, the machine will run with all current settings. In standby mode, the machine will turn off the motor. Toggling between standby and operational modes will not change individual motor on/off or speed settings. Hitting STOP will also pause the WATER PUMP.

The STOP button will be illuminated red during operational mode and white during standby mode.

For normal day-to-day operations, the Maker™ should be turned off using the STOP button instead of the emergency stop.

WATER PUMP

Selecting the WATER PUMP button will energize the receptacle on the side of the control box. This will cause the pump to run until the WATER PUMP button is pressed again or the STOP button is pushed. The WATER PUMP button will be highlighted in white with a red border when selected.

NOTICE The power switch on the external water pump must be in the on position to run.

SAVE

This button can be used to save different preset recipes. Once selected there will be the ability to edit all applicable settings (speed, duration, pause, and auto runtime). Once all settings are selected they can be saved to memory (1-10) by selecting the desired location and a confirmation will be displayed above the pause time. Close the window to proceed.

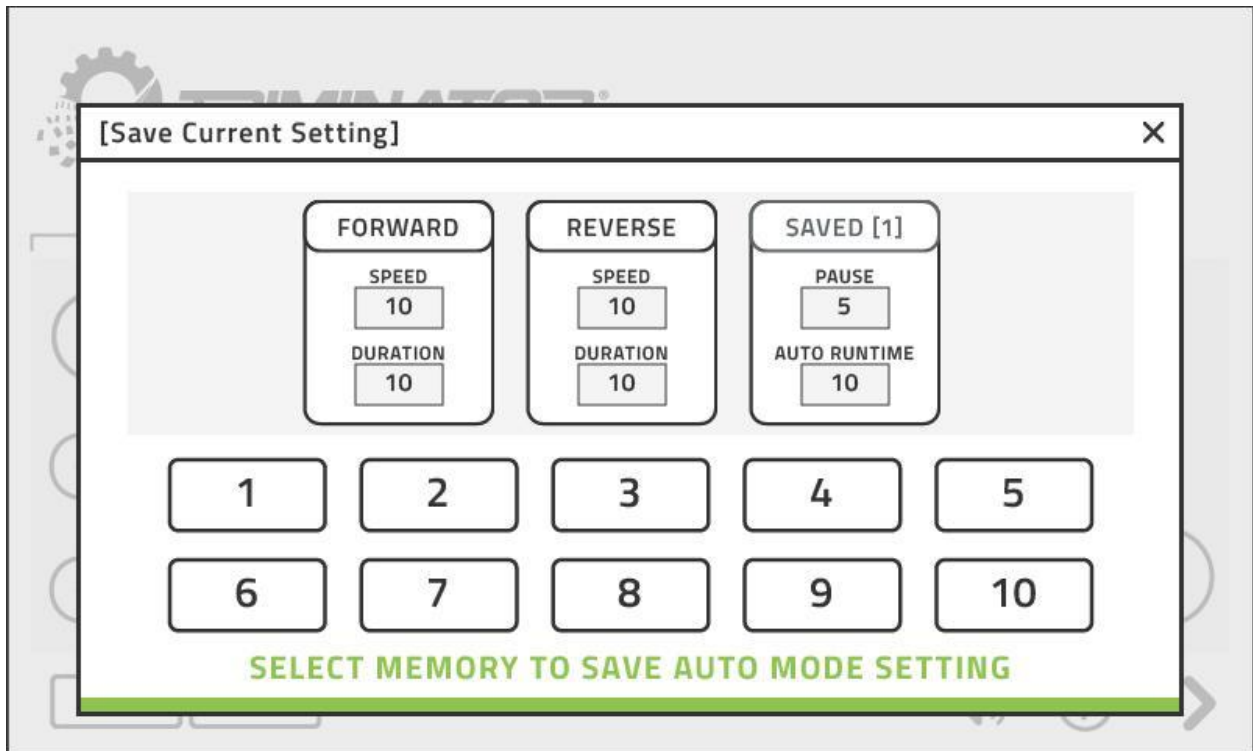

RECALL

This button can be used to retrieve saved recipes. Once selected there will be the ability to select the desired memory slot (1-10) and a confirmation will be displayed above the pause time. Close the window to proceed.

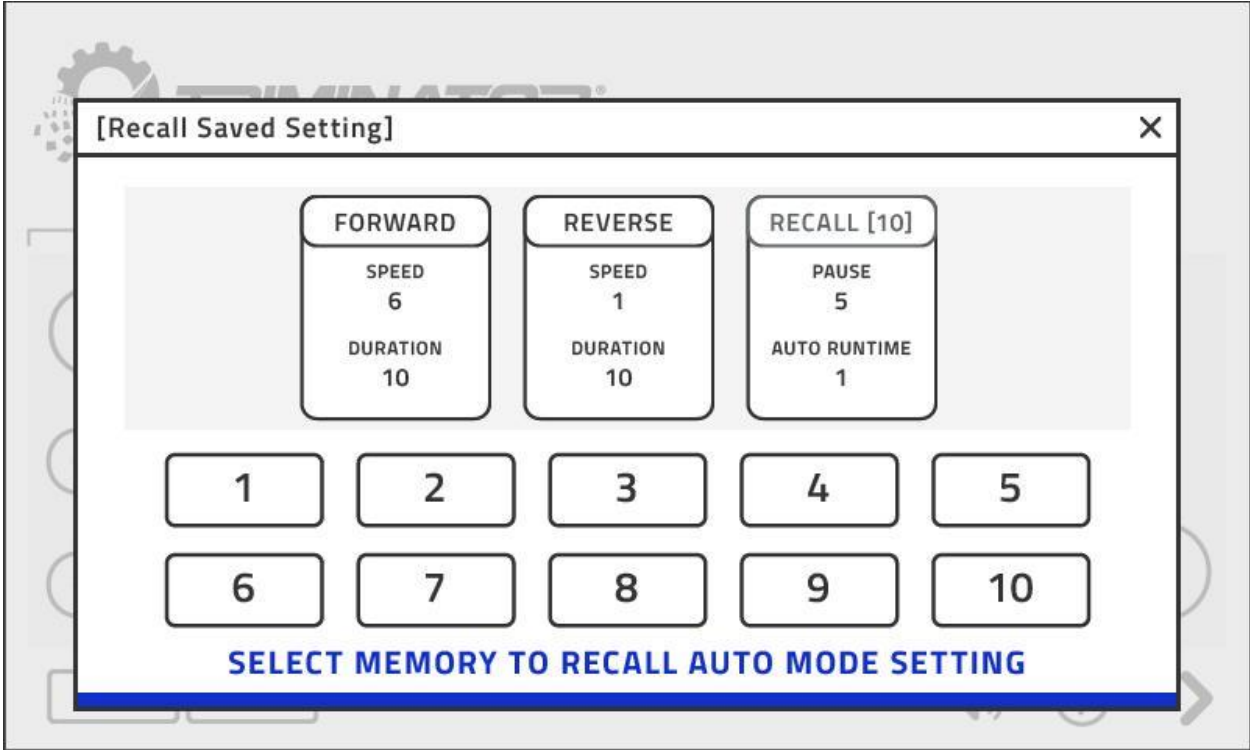

SOUND 🔊

An audible alert will sound once the auto cycle has completed. The silence button can be selected to mute the alert.

INFO ⓘ

When selected, a popup window will display a brief description of the settings/modes that can be viewed.

SYSTEM USAGE >

When selected, the HMI will display system usage information including run time. If > is selected, it will display the diagnostics screen. To return to the main menu, press <.

WASHING VESSEL TILT

The pin can be turned to disengage the spring and allow the tank to turn freely. During normal use, only the pin on the controller side (right) should be used to adjust the position of the washing vessel.



NOTICE Ensure pins are engaged during transport and operation.

CONTROLLER SIDE (Right)

Can lock the pin at 0, 45, and 90 degrees.



NON-CONTROLLER SIDE (Left)

Free spin (to tilt backward or more than 90 degrees).



DRAIN VALVES

Used to control the flow of water from the washing vessel to the collection vessel and from the collection vessel to the water pump. When the handle is parallel to the spout, the valve will be open and is closed when perpendicular. To switch between positions the black knob must be pulled outwards.



SOAK WEIGHT

If you want to rehydrate material you can use the rehydrating plate by placing it over the material/water to submerge it and allow the dry material to rehydrate for approximately 20 minutes.

NOTICE Remove plate before washing.

BAG HOLDER

The bag holder sits on top of the collection vessel. Roll micron bag tops over the top of the bag holder. Multiple bags can be nested inside each other. Be sure to sinch each bag's drawstring snug to prevent it from falling into the vessel.

SETUP

OPERATING CONDITIONS

Location	Indoor or covered outdoor
Altitude	0-2000 m (0-6500 ft) above sea level
Temperature (Ambient)	5°C - 40°C (40°F - 105°F)
Maximum Relative Humidity	80% at 31°C (88°F), decreasing linearly to 50% at 40°C (105°F)
Voltage and Current Rating	60 Hz: 120 V, 16 A 50 Hz: 240 V, 8 A
Overvoltage Category	II

Environment: While the Maker™ can be used in a variety of conditions, the best results are achieved in spaces with low humidity and cool temperatures.

NOTICE This machine should not be operated in conditions or orientations where accessing the emergency stop would be difficult or impossible. Always ensure that any operators have clear access to the power off and e-stop buttons.

NOTICE If this equipment is used in conditions outside the specified operating conditions, Eteros Technologies cannot guarantee that the built-in safety functions of the Trinator Maker™ will function as intended.

UNCRATING THE MAKER™

Your Triminator Maker™ will arrive with the primary assemblies ready for operation.

1. Remove screws to open the front and rear of the shipping crate.
2. Release the ratchet straps from the collection vessel. Then remove 2x4 crosser boards to release all components.
3. With the help of another person, lift the collection vessel from the crate. The stand assembly with the mixing tank can now be removed using a forklift beneath the upper cross member.
4. Remove all packaging materials and refer to [Components page](#) to ensure all partss arrive in good condition and begin assembly.



ASSEMBLY / DISASSEMBLY

IMPELLER REMOVAL/INSTALLATION

The impeller sits on the bottom of the washing vessel just above the false bottom. To remove the impeller, grasp it on opposite sides and pull upward until the spring pin releases. To reinstall, repeat the process but in reverse with downward pressure until the spring pin engages.

FALSE BOTTOM REMOVAL

To remove/install the false bottom, the impeller must be removed first. Grasp the handles of the false bottom and lift up to remove. To install, insert back into the bottom of the vessel ensuring that the opening for the impeller shaft is positioned correctly.

NOTICE Ensure the false bottom clears the thermometer probe and sits flush on the bottom of the washing vessel.

DRAIN VALVE(S) INSTALLATION / REMOVAL

To facilitate regular cleaning, the drain valves are designed to allow for quick, tool-free removal.

REMOVAL

1. Make sure the machine is powered off and all motors have stopped turning.
2. Unplug the power cords.
3. Use the thumb screw to loosen the hose clamp.
4. While holding the valve in one hand swing the screw away from the clamp and open it up.
5. Remove the clamp valve and O-ring from the Maker™.

INSTALLATION

The drain valves can be re-installed by following the above steps in reverse order.

NOTICE Ensure that the O-ring is in place between the vessel and spout before tightening the clamp.



WATER PUMP INSTALLATION/REMOVAL

WATER PUMP INSTALLATION

1. Ensure that the motor is placed on the floor beside the Maker™.
2. Connect the shorter hose between the collection vessel and pump inlet using the provided hose clamps.

NOTICE Ensure that the O-ring is in place between the vessel/pump and hose.

3. Connect the longer hose between the pump outlet and washing vessel using the provided hose clamps.

NOTICE Ensure that the O-ring is in place between the vessel/pump and hose.

4. Plug the pump into the power receptacle on the side of the Maker™ control box.

NOTICE THE POWER SWITCH ON THE EXTERNAL WATER PUMP MUST BE IN THE ON POSITION TO RUN.



WATER PUMP REMOVAL

Repeat the installation instructions in reverse order.



THERMOMETER REMOVAL / INSTALLATION

The thermometer can be removed to provide access for cleaning.

THERMOMETER REMOVAL

1. Loosen off the screw on the hose clamp.
2. Remove thermometer from the tank, make sure not to lose O-ring.

THERMOMETER INSTALLATION

1. Ensure O-ring is installed between the thermometer and washing vessel.
2. Secure in place by tightening the screw on the hose clamp.

WASH BAG HOLDER INSTALLATION

The bag holder is used with the washing vessels to hold the washing bags in place.

1. Place the wash bag holder centered on top of the washing vessel.
2. Install the smallest micron-size bag through the rings and secure with the drawstring around the lowest ring of the holder.
3. Repeat this process with increasing bag sizes and moving up one ring per bag.



SOAK WEIGHT INSTALLATION

When washing dried material, it may be desirable to rehydrate it first. To do so, the soak weight can be used to submerge dried material prior to washing.

1. Insert the soak weight into the top of the washing vessel, making sure it sits below the elbow for water return from the pump.

2. Ensure that the hooks are sitting along the upper edge of the washing vessel.

NOTICE Remove the soak weight prior to washing.



OPERATION

BEFORE YOU START

SAFETY CHECK

NOTICE Please take the following steps to confirm the Maker™ is ready to operate:

- Complete a thorough inspection of the equipment to ensure no damage occurred during shipment.
- Confirm the power cords are in good condition.
- Ensure the false bottom is properly seated and that the impeller is installed and locked into place. (See [Drain Valve Installation](#)).

MACHINE START-UP SEQUENCE

1. START THE IMPELLER MOTOR

Press the VACUUM button; the vacuum is on when the red status light is on.

NOTICE Never start the impeller with the soak weight installed.

2. START THE WATER PUMP

Press the WATER PUMP button to begin recirculating water from the collection vessel to the washing vessel.

NOTICE Ensure that the water pump is plugged into the outlet on the Maker™ control box.

NOTICE Ensure that the switch on the water pump is in the ON position.

NOTICE Do not run the water pump when the collection vessel is dry/empty.

MACHINE STOP SEQUENCE

1. POWER DOWN

All motors can be stopped at once by pressing the main START/STOP button.

Alternatively, the water pump can be stopped individually under normal circumstances by toggling the WATER PUMP button.

2. DISCONNECT

With the motors stopped, disconnect the power cords.

WASHING PLANT MATERIAL

With the Maker™ turned off and the washing vessel in the upright position, ensure that the drain valves are closed.

1. LOAD THE WASHING VESSEL

Very dependent on user preferences

Option 1 (Fresh Frozen)

- Fill halfway with ice
- Add material to be washed
- Cover with more ice
- Fill remainder of tank with cold water to approximately 6 inches from the top of the washing tank
- Some people will wash immediately, others will wait for material to reach 32°F/0°C

Option 2 (Fresh Frozen)

- Fill tank 2/3 - 3/4 with ice and cold water
- Leave enough room for material
- Before adding material water should reach approx 32°F or 0°C
 - The colder the water the better the results
- Add material to chilled water

Option 3 (Dry Material)

- You can follow the same steps as options 1-2
- If you want to rehydrate material you can use the rehydrating plate by placing it over the material/water to submerge it and allow the dry material to rehydrate for approximately 20 minutes
- Remove plate before washing

2. RUN A WASH CYCLE (PULL)

- Run a wash cycle at the desired setting



Be careful not to put your hand inside the washing vessel while running

3. DRAIN TO COLLECTION VESSEL

- Ensure that the collection vessel is positioned correctly below the drain valve of the washing vessel and that the required bubble bags are installed correctly on the bag holder
- Open valve and allow water to drain into collection vessel
- Close the valve once fully drained

4. COLLECT BUBBLE HASH

- Rinse sides of micron bag and slowly pull it up until almost flat at the top
 - This allows the hash to collect in the center of the bags
- Scoop out the collected hash and place in an appropriate container for drying
- Repeat this process for each bag



5. RECIRCULATE TO WASHING VESSEL

- **You can start another wash cycle and allow it to run while collecting the hash from your first wash cycle**
- Open the drain valve of the washing tank and press the WATER PUMP button to recirculate the water back into the washing vessel
- Close the collection tank drain valve once the water has been drained from it
- Add ice if necessary

6. START NEXT WASH CYCLE

- Repeat the washing cycle once the water has been recirculated to the washing vessel

7. REPEAT AS DESIRED

- Perform as many wash cycles as desired

WASHING TIPS

- For best efficiency, run large batches of similar material through the machine. Each plant's properties are different, so duration and settings may need to be adjusted.
- Use multiple bubble bags for better separation and to isolate different grades of hash.
- The highest quality hash typically comes from the second through fourth washings. Washings 1 and 5 typically have more broken trichrome heads and are of lesser quality.
 - First/largest micron bag will have plant matter in it and is not viable.
- A cold spoon (stored in a freezer) can be used to easily collect the hash and help prevent sticking.
- The collected hash will need to be dried to avoid contamination issues. The preferred method is by freeze-drying.
- Use high-quality cannabis material. If using dried cannabis, ensure that it has been properly cured.
- Maintain precise control over water and ice temperatures during extraction.

PRE-LOADED SETTINGS

The Maker™ will come with pre-loaded wash recipes on the main screen that will populate on startup. The recipe settings and names can be overwritten as needed.

CLEANING YOUR MAKER™

The tool-less disassembly of the machine allows for easy breakdown and cleaning. With the exception of the control panel, impeller motor, and water pump, the machine can be pressure washed.

NOTICE After the final washing you do not have to recover the water into the washing tank.

1. POWER DOWN

Shut off motors. Unplug power cords.

2. DRAIN COLLECTION VESSEL

Disconnect hose from collection vessel and open valve to drain water. Reconnect the hose once completed.

3. EMPTY WASHING VESSEL

Tilt washing tank forwards and scoop out used material into garbage. Rinse any residual waste from the tank and allow to drain.

4. WASH INTERIOR OF VESSELS

1. Fill the washing vessel with a mixture of cleaner such as [GMP Solutions Step 1 Cleaner](#) and hot water and allow a wash cycle to run.
2. Once the cycle is complete, drain the solution into the collection vessel and allow it to sit.
3. The water pump can then be engaged to recirculate the solution to the wash vessel.
4. Disconnect the hose from the wash vessel and allow it to drain completely while rinsing with water. Reconnect the hose.
5. Fill the wash vessel with clean water and repeat steps 1-3 from this section.
6. Remove all hoses, the impeller, and false bottom, and rinse all components one final time.
7. Allow to air dry.

5. WASH EXTERIOR OF VESSELS

Using a pressure washer with no more than 1800 PSI, lightly spray all components (EXCEPT for the HMI, impeller motor, and water pump assembly) with soap or degreaser, such as **GMP Solutions Step 1 Cleaner**.

6. RINSE

Using a pressure washer with no more than 1800 PSI rinse the degreaser from all components (EXCEPT for the HMI, impeller motor, and water pump assembly).

NOTICE For best results, use hot water whenever possible. Be careful when selecting the degreaser to ensure it will not damage the painted components of the Maker™. Always follow the operating instructions provided with the pressure washer.

HAND-CLEANING THE IMPELLER MOTOR AND WATER PUMP

1. PRE-SOAK

Cover with a cleaner, such as **Step 1 Cleaner**, and follow cleaner's instructions for proper use.

2. HAND WASH

Using warm/hot water and a scrubber, clean the impeller motor and water pump.

3. RINSE

Remove the soap residue with a damp cloth and let the components air dry.

HAND-CLEANING THE HMI

Wipe the HMI screen with a damp cloth soaked in cleaner, such as **Step 1 Cleaner**. Remove the soap residue with a damp cloth and let it air dry.

MAINTENANCE

SERVICING YOUR MAKER™

Proper maintenance is essential for safe, economical, and trouble-free operation. To properly care for your Maker™ has washer, follow the maintenance schedule. Other service tasks that are more

difficult, or require special tools, are best handled by professionals and are normally performed by a Trinator technician.

To ensure the best quality and reliability, use only new, Trinator genuine parts or their equivalents for repair and replacement.

Some of the most important safety precautions follow. However, we cannot warn you of every conceivable hazard that can arise in performing maintenance. Only you can decide whether or not you should perform a given task. Failure to properly follow maintenance instructions and precautions can cause you to be seriously hurt or killed. Always follow the procedures and precautions in this User Guide.

SAFETY PRECAUTIONS

Make sure all motors are off and power cords are unplugged before you begin any maintenance or repairs. Read the instructions before you begin, and make sure you have the tools and skills required.

BREAKERS/FUSES

The Maker™ is equipped with a reset breaker and replaceable fuse to protect operators and the equipment from potentially dangerous conditions. In the unlikely event of a breaker tripping or fuse blowing, allow the Maker™ to cool down and investigate for any potential causes. Reset the breaker or replace the fuse to restore operation.

The breaker and fuse are located inside the control box. If there is no power to just the HMI, then the 3 amp fuse will need to be replaced. If there is no power to the entire unit, then the breaker should be reset.

REMOVING OBSTRUCTIONS

If the Maker™ becomes restricted or clogged:

WARNING Be sure the machine is off and disconnected from a power source before attempting to clear any obstruction.

1. Press the emergency stop.

2. Make sure that all rotating parts have come to a complete stop.
3. Disconnect the Maker's power cords.
4. Remove the impeller and false bottom to inspect for obstructions.
5. Disconnect the valves/hoses and inspect for obstructions.
6. Clear any obstruction(s).
7. Check all components for damage. Repair/replace them as required.

NOTICE Be careful not to bend or break any parts with excess force when clearing obstructions.

MAINTENANCE SCHEDULE

BEFORE EACH USE	<p>Inspect all electrical cords for damage and replace as required. Never use a damaged or frayed power cord.</p> <p>Ensure the false bottom, impeller, thermometer, hoses, and drain valves are installed correctly.</p>
DURING EACH USE	<p>Monitor impeller, false bottom, and hoses for product build-up and remove build-up as required.</p> <p>Listen for and recognize significant changes to the sound of the machine during use as this usually indicates a problem. Locate and address the source of the noise before proceeding.</p>
AFTER EACH USE	<p>Remove all loose material.</p> <p>Clean all machine components.</p>
EVERY 10 HOURS OF OPERATIONS	<p>Inspect the impeller and hoses for excessive wear.</p> <p>Check for loose fasteners and tighten as required.</p>

TROUBLESHOOTING

SYMPTOM	POSSIBLE CAUSE	CORRECTION
NO POWER TO HMI OR BLANK SCREEN	No electric power from the outlet	Plug Maker™ into a functional electrical outlet.
	Blown fuse	Assess fuse inside of the control box, replace if required (3 Amp).
	Tripped internal breaker	Assess breaker inside of control box and reset as necessary.
	Outlet is overloaded	Check that the breaker on your main electrical panel is not overloaded and has not tripped. If tripped, switch plug to a different circuit.
	Overcurrent circuit has been exceeded	Determine the cause of the excessive circuit resistance which may include: overloaded outlet, faulty extension cord, bad outlet, underrated generator, excessively dirty machine, or an obstruction in the machine.

SYMPTOM	POSSIBLE CAUSE	CORRECTION
IMPELLER MOTOR WILL NOT START OR HAS LOW POWER	No electric power from the outlet	Plug Maker™ into a functional electrical outlet.
	Outlet is overloaded	Check that the breaker is not overloaded and has not tripped. If tripped, switch the plug to a different circuit.
	Extension cord is faulty	Check that extension cord, if used, is rated appropriately for the distance and current. Do NOT use a longer cord unless the wire size is larger. Undersized extension cords may cause an undervoltage, over-current condition that could damage or destroy the drive motor and void the motor warranty.
	Overcurrent circuit has been exceeded	Determine the cause of the excessive circuit resistance which may include: overloaded outlet, faulty extension cord, bad outlet, underrated generator, excessively dirty machine, or an obstruction in the machine.
	Impeller may be obstructed	Remove the impeller from the drive shaft and inspect for obstructions and clear as required.

SYMPTOM	POSSIBLE CAUSE	CORRECTION
WATER PUMP WILL NOT RUN	Not plugged into control box	Ensure it is plugged into the outlet on the side of the control box.
	Not selected on HMI	Ensure the WATER PUMP button has been selected, it will be highlighted when active.
	Power switch is in the OFF position	Ensure the power switch on the pump is in the ON position.

SYMPTOM	POSSIBLE CAUSE	CORRECTION
VESSELS WILL NOT DRAIN	Obstruction in valve or hose	Clear the obstruction.
	Water pump not on	Ensure that the water pump is plugged into the outlet on the control panel. Ensure the switch on the pump is in the ON position. Ensure the WATER PUMP button is selected.