

GroLine

HI981413

Nutrient Dosing System



INSTRUCTION MANUAL

Dear
Customer,

Thank you for choosing a Hanna Instruments product.

Please read this instruction manual carefully before using this instrument.

This manual will provide you with the necessary information for correct use of this instrument, as well as a precise idea of its versatility.

If you need additional technical information, do not hesitate to e-mail us at tech@hannainst.com or view our contact list at www.hannainst.com.

All rights are reserved. Reproduction in whole or in part is prohibited without the written consent of the copyright owner, Hanna Instruments Inc., Woonsocket, Rhode Island, 02895, USA.

TABLE OF CONTENTS

1. PRELIMINARY EXAMINATION 4

2. SAFETY MEASURES 5

3. ABBREVIATIONS & CONVERSION CHARTS 5

4. SPECIFICATIONS 6

 4.1. HI981413 NUTRIENT DOSING SYSTEM 6

 4.2. HI30033 PROBE 7

5. DESCRIPTION 8

 5.1. GENERAL DESCRIPTION & INTENDED USE 8

 5.2. FUNCTIONAL & DISPLAY DESCRIPTION 10

6. INSTALLATION 14

7. SETUP 22

8. PUMP CONTROL 29

 8.1. AUTOMATIC CONTROL TYPES 29

 8.2. PRIMING THE PUMP 30

9. EVENT MANAGEMENT 31

 9.1. ALARMS 31

 9.2. WARNINGS 32

 9.3. SUMMARY OF GENERAL BEHAVIOR 32

10. CALIBRATION 33

 10.1. EC CALIBRATION 33

 10.2. PROCESS EC & TDS CALIBRATION 34

 10.3. CLEAR CALIBRATION 36

11. MEASUREMENT 37

12. ERROR MESSAGES 38

13. MAINTENANCE 39

 13.1. ELECTRODE CARE & MAINTENANCE 39

 13.2. PUMP TUBING REPLACEMENT 39

14. ACCESSORIES 42

CERTIFICATION 44

RECOMMENDATIONS FOR USERS 44

WARRANTY 45

1. PRELIMINARY EXAMINATION

Remove the instrument and accessories from the packaging and examine it carefully. For further assistance, please contact your local Hanna Instruments office or email us at tech@hannainst.com. Each HI981413 is available in multiple configurations: controller and probe - HI981413-00, kit for in-line mounting - HI981413-10, kit for flow cell mounting - HI981413-20.

Each instrument is supplied with:

HI981413-00, without mounting kit

- HI30033 EC / TDS / temperature probe
- HI7031-012 Conductivity calibration solution 1413 $\mu\text{S}/\text{cm}$, 120 mL
- Plastic beaker
- Power connection cable
- Instrument & electrode quality certificates
- Instruction manual

HI981413-10, with in-line mounting kit

- HI30033 EC / TDS / temperature probe
- HI7031-012 Conductivity calibration solution 1413 $\mu\text{S}/\text{cm}$, 120 mL
- Controller aspiration filter
- Controller injector, 1/2" NPT thread
- Saddle for \varnothing 50 mm pipe (2 pcs.)
- Plastic beaker
- Power connection cable
- Instrument & electrode quality certificates
- Instruction manual
- PVC aspiration tubing (flexible) length: 5 m OD: \varnothing 6.0 mm; ID: \varnothing 4.0 mm
- PE rigid dispensing tubing (pump to injector) length: 5 m OD: \varnothing 6.0 mm; ID: \varnothing 4.0 mm

HI981413-20, with flow cell mounting kit

- HI30033 EC / TDS / temperature probe
 - HI7031-012 Conductivity calibration solution 1413 $\mu\text{S}/\text{cm}$, 120 mL
 - Flow cell for HI981413
 - Mounting panel assembly for HI981413
 - Controller aspiration filter
 - Controller injector, 1/2" NPT thread
 - Saddle for \varnothing 50 mm pipe (3 pcs.)
 - Plastic beaker
 - Power connection cable
 - Instrument & electrode quality certificates
 - Instruction manual
 - Rapid coupling 1/2" to 12.0 mm (2 pcs.)
 - Flow cell valve (2 pcs.)
 - PVC aspiration tubing (flexible) length: 5 m OD: \varnothing 6.0 mm; ID: \varnothing 4.0 mm
 - PE rigid dispensing tubing (pump to injector) length: 5 m OD: \varnothing 6.0 mm; ID: \varnothing 4.0 mm
 - PE rigid tubing (flow cell) length: 10 m OD: \varnothing 12.0 mm; ID: \varnothing 10.0 mm
-

OD: Outer Diameter; ID: Inner Diameter

Note: Save all packing material until you are sure that the instrument works correctly. Any damaged or defective item must be returned in its original packing material with the supplied accessories.

2. SAFETY MEASURES



- Always disconnect the EC pump controller from power when making electrical connections.



- Do not run other cables with the power cabling.
- Do not touch the metallic part. Hot surface.

3. ABBREVIATIONS & CONVERSION CHARTS

LED	Light Emitting Diode
NPT	American National Standard Taper Pipe Thread
ID	Inner Diameter
OD	Outer Diameter
PE	Polyethylene
PVC	Polyvinyl Chloride
SPDT	Single Pole Double Throw

METRIC vs INCHES

Metric (mm)	Inches - Decimal	Inches - Fractional
4.0 mm	0.16"	$\frac{5}{32}$ "
6.0 mm	0.24"	$\frac{15}{64}$ "
10.0 mm	0.39"	$\frac{25}{64}$ "
12.0 mm	0.47"	$\frac{15}{32}$ "
20.0 mm	0.79"	$\frac{25}{32}$ "
25.4 mm	1.00"	1"
50.0 mm	1.97"	$1 \frac{31}{32}$ "
63.0 mm	2.48"	$2 \frac{31}{64}$ "
75.0 mm	2.95"	$2 \frac{61}{64}$ "

METRIC vs FEET & INCHES

Metric (m)	Feet (') Inches (")	Feet (')	Inches (")
2 m	6' 7"	6.56'	78.74"
5 m	16' 4"	16.40'	196.85"
10 m	32' 9"	32.80'	393.70"

4. SPECIFICATIONS

4.1. HI981413 NUTRIENT DOSING SYSTEM

Range	EC	0.00 to 10.00 mS/cm
	TDS	0 to 9900 ppm, depends on TDS factor i.e. with TDS factor 0.5, range 50 to 5000 ppm with TDS factor 0.7, range 70 to 7000 ppm
	Temperature*	-5.0 to 105.0 °C (23.0 to 221.0 °F)
Resolution	EC	0.01 mS/cm
	TDS	1 ppm
	Temperature	0.1 °C (0.1 °F)
Accuracy @ 25 °C / 77 °F	EC	± 0.10 mS/cm (0.00 to 5.00 mS/cm) ± 0.20 mS/cm (5.00 to 10.00 mS/cm)
	TDS	± 2% F.S. ± 50 (0 to 2500 ppm) with TDS factor 0.5 ± 100 (2500 to 5000 ppm) with TDS factor 0.5
	Temperature	± 0.5 °C (± 0.9 °F)
	Calibration	<ul style="list-style-type: none"> • User calibration: automatic, one-point with standard solution (1.41 or 5.00 mS/cm) • Process calibration: single point, adjustable (± 0.50 mS/cm around measured value) • The corresponding value in TDS, depends on TDS factor
Temperature Compensation	Automatic	
EC to TDS Conversion Factor	TDS factor selectable from 0.45 to 0.99	
High or Low Mode Operation Pump Control	<ul style="list-style-type: none"> • On/Off control using adjustable set point (0.10 to 10.00 mS/cm; 45 to 9900 ppm, depends on TDS factor) with adjustable hysteresis (0.05 to 0.50 mS/cm; 23 to 495 ppm, depends on TDS factor) • Proportional control using adjustable set point (0.10 to 10.00 mS/cm; 45 to 9900 ppm, depends on TDS factor) with adjustable proportional band (0.05 to 1.00 mS/cm; 23 to 990 ppm, depends on TDS factor) • Startup delay timer at power-on (0 to 600 sec.) • Pump flow control 0.5 to 3.5 Liter/hour (0.13 to 0.92 Gallon/hour) and maximum output pressure 1 atm (14 psi) • Manual control for pump priming (defined in setup) 	

*The range may be limited by the probe's limits.

EC/TDS Alarms	<ul style="list-style-type: none"> • High & Low with enable or disable option • Triggered after 5 sec. if the controller records consecutive readings over or under threshold values • Level with enable or disable option • Overtime protection (1 to 180 min. or Off)
Controller Alarm System	<ul style="list-style-type: none"> • Intuitive alarm system, using red, yellow and green color coded backlight • User-selectable, alarm setup options
Alarm Relay Output	<ul style="list-style-type: none"> • SPDT 2.5A / 230 Vac • Activated by EC/TDS - selectable alarm conditions
Probe Input	<ul style="list-style-type: none"> • Quick connect DIN connector • Galvanic isolation
Level Sensor Input (Digital Input)	<ul style="list-style-type: none"> • External switches can be attached to stop the pump and activate the alarm (low reagent level) when the switch is open and level alarm is configured in Setup • Galvanic isolation
Power Supply	100 - 240 Vac, 50/60 Hz
Power Consumption	15 VA
Environment	0 to 50 °C (32 to 122 °F), max. 95% RH non-condensing
Dimensions	90 x 142 x 80 mm (3.5 x 5.6 x 1.8")
Weight	908 g (36 oz)
Casing	Wall mounted, built-in pump, IP65 rating

4.2. HI30033 PROBE

Range	0-10 mS/cm
Pin	Stainless steel
Temperature sensor	Yes
Temperature range	-5 to 60 °C (23 to 140 °F)
Body	PVDF (white)
Top thread	¾" NPT
In-line mounting thread	½" NPT
Cable length	2 m
Connector	Quick connect DIN connector
Maximum pressure @25 °C	3 bar (43.5 psi)

5. DESCRIPTION

5.1. GENERAL DESCRIPTION & INTENDED USE

The HI981413 Nutrient Dosing System is part of Hanna Instruments Groline family and features a durable EC controller with peristaltic dosing pump and a robust EC process sensor. The HI981413 has been designed to easily assimilate into a nutrient/fertilizer system to provide around the clock monitoring and adjustment of hydroponic nutrient solutions to ensure operational consistency.

Nutrient management requires monitoring and optimizing nutrient levels efficiently before applying to plants. In a freshly made solution, EC is the best way to verify that the resultant fertilizer agrees with the fertilizer manufacturer's recommendations.

Nutrients required for thriving plant growth are supplied through liquid nutrient solutions that contain dissolved salts which are conductive. Conductivity measurements detect the amount of salts that have been dissolved in the water. A higher EC indicates more salts have been dissolved and a lower EC indicates a lower total salt concentration.

The HI981413 Nutrient Dosing System precisely monitors and displays the conductivity measured by the HI30033 waterproof EC/Temperature probe and simultaneously controls the addition of nutrient fertilizer using On/Off or proportional control. Growers can define the ideal set point in conductivity (mS/cm) or TDS (ppm) units. The HI981413 is a small dosing controller and can be easily setup for a stand-alone nutrient reservoir or be part of a modular control scheme with the HI981412 Groline pH Dosing controller.

To obtain a representative conductivity measurement, the probe should be located at a spot that experiences good circulation but is free from bubbles. The probe can be used in a "sample pot" or reservoir or installed in a flow cell or recirculation line; perfect for drain-to waste or recirculating systems.

Main Features

- Easy to read LCD display with intuitive, color-coded backlight
- Automatic Temperature Compensation: all readings are compensated for variations in temperature. Temperature is displayed in °C or °F along with EC or TDS reading. The EC probe contains an integral temperature sensor to simplify installation.
- Configurable EC to TDS/ppm conversion factor. Most commonly a TDS factor of 0.5 is used for 0 to 5000 ppm (500 CF) or a TDS factor of 0.7 is used for 0 to 7000 ppm (700 CF).
- High and low alarms: warn the user when the nutrient solution is out of desired range by blinking the LCD backlight red, disabling the pump, and deactivating the alarm relay
- Built-in peristaltic pump with On/Off or Proportional control
- Manual control for pump priming
- Overfeed protection using the overtime safety timer
- Resumes dosing on restart in case of power failure
- IP65 rated enclosure designed to withstand harsh environments
- Level input to stop control when nutrient levels are low
- Wall-mounted design
- User selectable languages
- Extremely easy to calibrate and use (prepackaged calibration standards)

The **HI981413** Groline Nutrient Dosing System is designed to ensure smooth, safe and efficient nutrient use in growing operations and to grow healthy plants economically.

5.2. FUNCTIONAL & DISPLAY DESCRIPTION

Front Panel

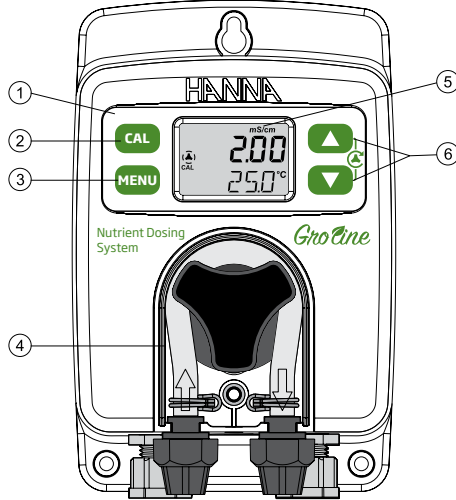

1. Keypad area
2. CAL key – Press calibration key to enter calibration mode.
3. MENU key – Press menu key to enter setup mode and move through the menu. Long press menu key to exit the menu and return to measurement.
4. Dosing pump
5. LCD display
6. Arrow keys – When in measurement mode, press the two arrow keys together to prime the pump.
 - When in menu mode, adjust settings.
 - When in menu mode (Control screen), press the arrow keys together and a 10 seconds pump test will start.

Liquid Crystal Display (LCD)

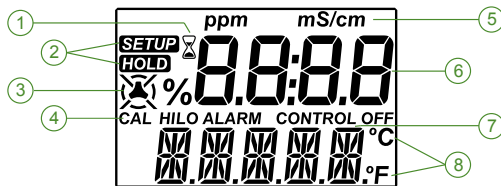

- | | |
|------------------------|--|
| 1. Stability indicator | 5. Measurement unit |
| 2. Mode tags | 6. First LCD line, measurement line |
| 3. Dosing pump icon | 7. Second LCD line, temperature and message area |
| 4. Status indicators | 8. Temperature units |

Internal Rear Panel

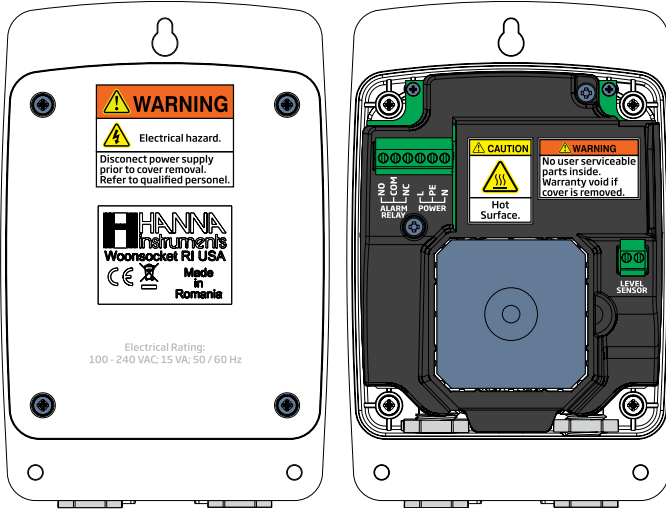

Use a Phillips head screwdriver and remove the four screws, pull back the cover and remove it.

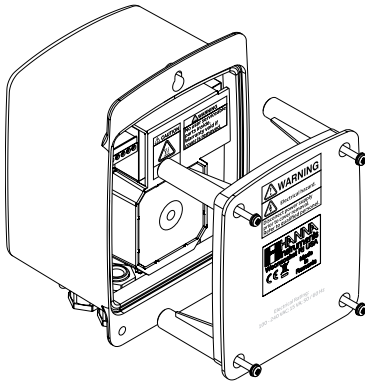

To replace the rear panel, insert the four legs back in place and tighten the four screws that secure the panel to the enclosure.

Alarm Relay, Power & Level Sensor

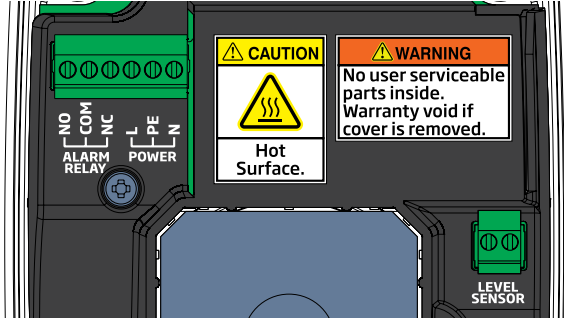

ALARM RELAY OUTPUT SPDT 2.5 A / 230 Vac	NO	Normally Open
	COM	Common
	NC	Normally Closed
	Pump controller not powered or Alarm condition	
	Working condition with no alarm	

POWER INPUT	L	Line – Hot connection
	PE	Protective Earth – Ground connection
	N	Neutral

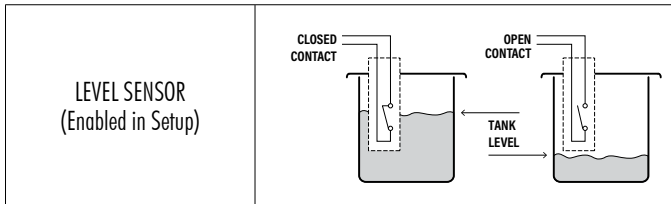

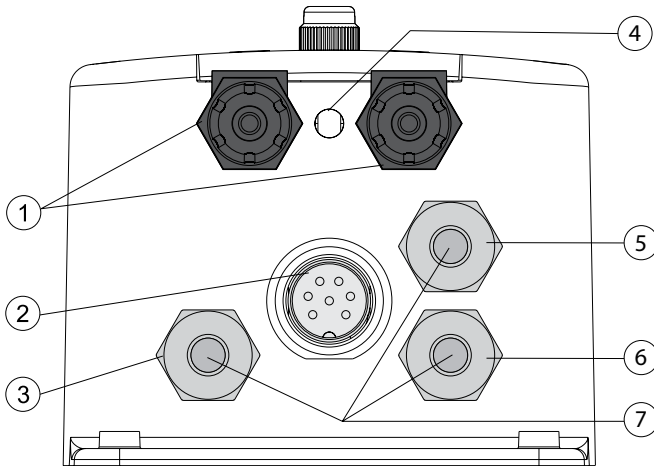

1	Tubing fittings
2	Sensor input
3	Cable gland for level sensor cable
4	Drainage opening
5	Cable gland for alarm cable
6	Cable gland for power cable
7	Enclosure cap

Cabling safety measures. Qualified personnel should perform wiring only.



- A disconnect switch must be installed to break all current carrying conductors. Turn off power before working on conductors.
- Always disconnect the pump controller from power when making electrical connections.
- Do not run other cables with the power cable through the cable gland.
- Always run all cables through cable glands to maintain IP65 rating and block unused holes with cable seal plugs.

6. INSTALLATION

General Guidelines

- Select controller location so that it is shielded from direct sunlight, dripping water and excess vibrations.
- Select the nutrient injector point away from the sampling point to prevent triggering an alarm.
- Keep flow rate as constant as possible for optimum sensor operation.
- Install cable gland fittings and plugs, to properly seal the pump controller.
- The probe is easily installed using ½" NPT threads for in-line or flow cell installation, and ¾" NPT thread for reservoir immersion installation.
- Ensure all tubing, cables, saddles and fittings are properly connected.

Note: *HI981413-10 and HI981413-20 Groline Nutrient controllers are shipped with two types of tubing, for both flow cell and in-line configurations:*

- rigid tubing for outlet (dispensing) - connects the pump output to the injector
- flexible tubing for inlet (aspiration) - connects the filter to the pump inlet

Wiring Guidelines

Running cables through cable glands

- Unscrew the gland nut and remove the cap.
- Thread cable through outer opening of proper gland nut, through the seal, and into case.
- After connecting to terminal, reinsert seal and tighten nut on the threaded gland.

Connecting cables to the internal terminals

- Using a screwdriver, connect the cable leads to the appropriate terminal.
- Following the printed lead markings (L, PE, N for power supply; NO, COM, NC for relay; level sensor if required) ensure the leads are wired to the correct position.

Installation Steps

1. Check the nutrient tank level.
2. Calibrate the EC probe before installing in the system.
3. Mount the probe into saddle or into a flow cell.
4. Connect the aspiration tubing between the chemical tank and the pump's inlet.
5. Connect the dispensing tubing between the pump and injector.
6. Check the level sensor's functionality (if used).

Possible Installation Schemes for a Recirculating System

In-Line Installation, Overview & Parts Table

Below is an illustrated reference of a generic in-line installation scheme with the relevant components. The maximum pressure entering the flow cell system is 3 atm (44 psi).

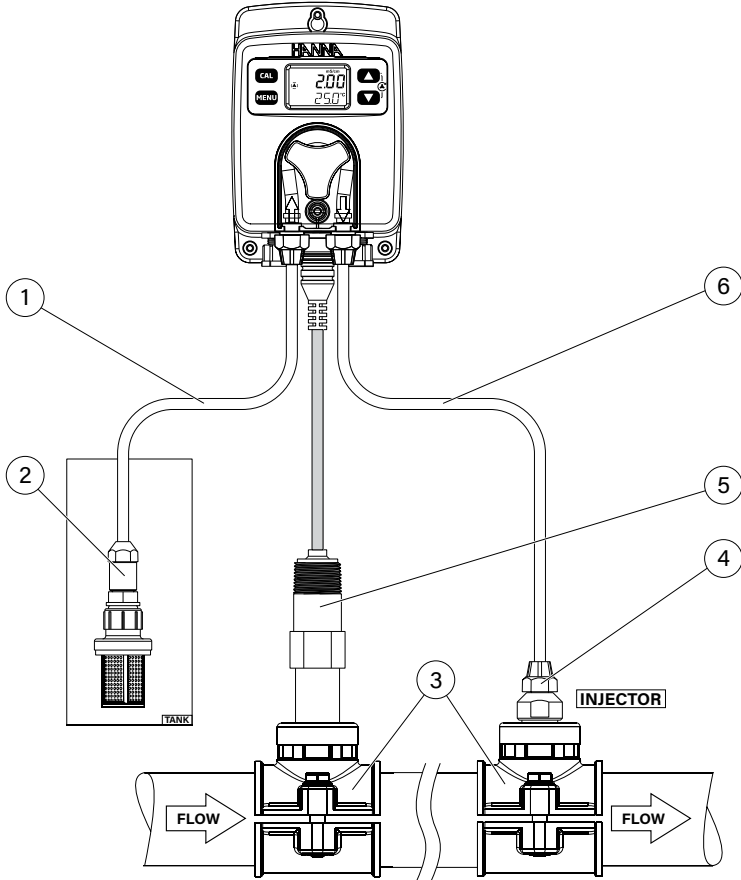

Note: Injectors prevent back flow into reagent tank.

1	Flexible PVC tubing Ø 6.0 mm and Ø ¼"
2	Aspiration filter
3	Saddle for Ø 50 mm (2") pipe, using ½" NPT thread
4	Injector, ½" NPT thread
5	EC probe
6	Rigid PE tubing Ø 6.0 mm and Ø ¼"

Flow Cell Installation, Overview & Parts Table

Below is an illustrated reference of a generic flow-cell installation scheme with the relevant components. The maximum pressure entering the flow cell system (P1) is 3 atm (44 psi) and decreases when it exits the flow-cell (P2). The maximum pressure for the pump (P3) is 1 atm (14 psi).

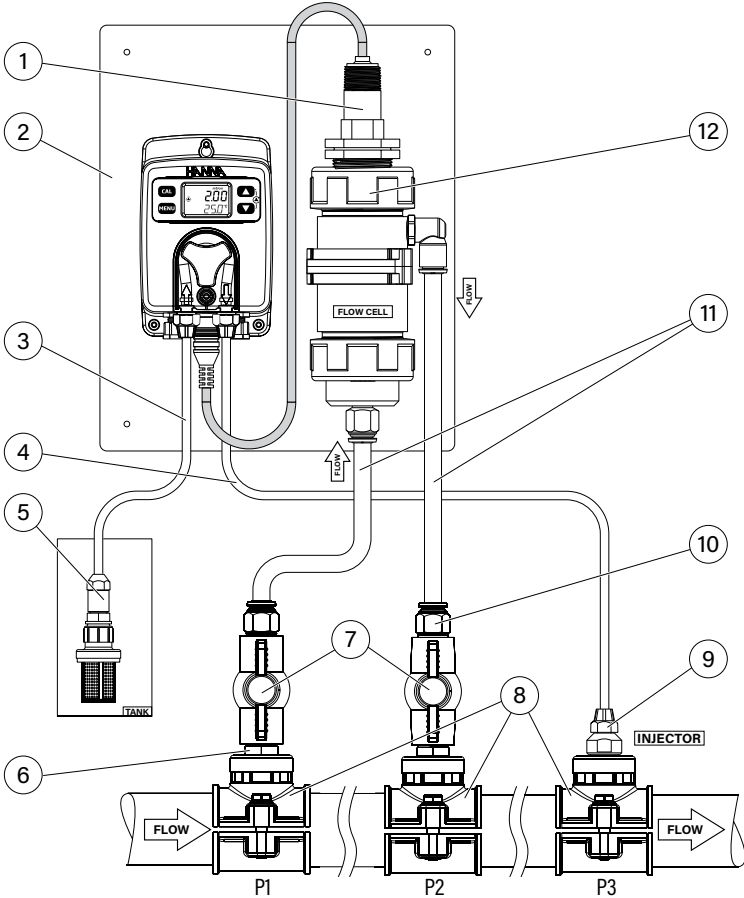

1	EC probe	8	Saddle for Ø 50 mm (2") pipe, using ½" NPT thread
2	Mounting panel	9	Injector, ½" NPT thread
3	Flexible PVC tubing Ø 6.0 mm and Ø ¼"	10	Adapter for tubing ½" to Ø 12.0 mm
4	Rigid PE tubing Ø 6.0 mm and Ø ¼"	11	Rigid PE tubing Ø 12.0 mm
5	Aspiration filter	12	Flow cell and adapter
6	Nipple, ½" to ½"		
7	Valve to control flow-cell flow		

Reservoir Immersion Installation

Detailed below a representation of a reservoir immersion installation scheme together with the relevant components and the EC probe screwed into the threaded end of a user supplied pipe and fastened with a bracket.

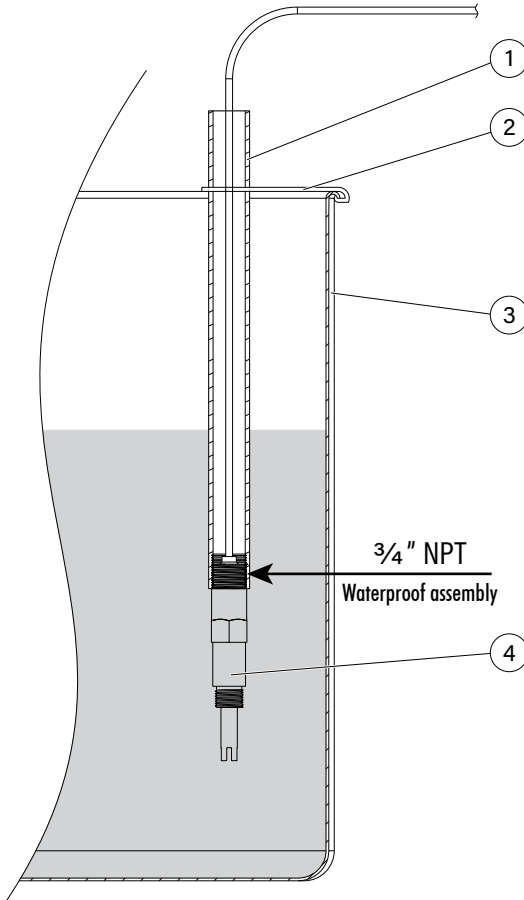

1	Electrode holder tube
2	Bracket
3	Reservoir
4	Probe

Note: It is recommended to keep the waterproof probe fastened during measurements and that only the probe body is continuously submerged.

Mounting Recommendations for Saddle

- Select required drill size. See table for dimension details.

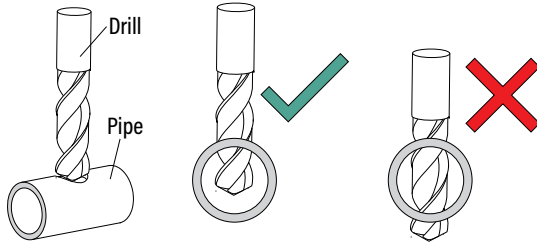

- Place the upper part of the saddle (3) on top of the pipe (5) with the seal (4) placed over the hole.
- Take the lower part of the saddle (6), together with inserted nuts (7) and align it under the upper part.
- Insert the screws (1) with washers (2) through the holes and tighten by hand into the mounted nuts.
- Using a wrench, tighten all screws carefully.

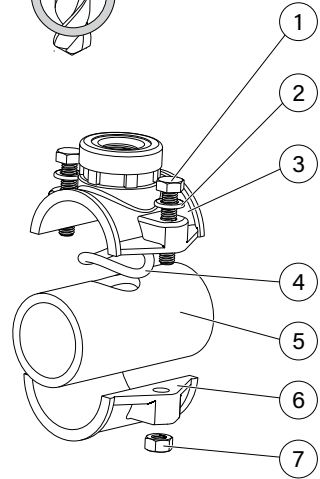

Saddle for probe & injector	Thread size	Drill size
Ø 50 mm pipe	½" NPT thread	20 mm - 25.4 mm
Ø 63 mm pipe	½" NPT thread	20 mm - 25.4 mm
Ø 75 mm pipe	½" NPT thread	20 mm - 25.4 mm

Connecting the Probe to the Pump Controller (In-line Configuration)

- The probe should be connected to the controller and calibrated before installation.
- To avoid twisting the cable, unplug probe from socket temporarily while installing in saddle.
- Insert the probe and screw it carefully into the saddle, taking care not to damage the O-ring. Tighten the probe enough to ensure a tight seal.

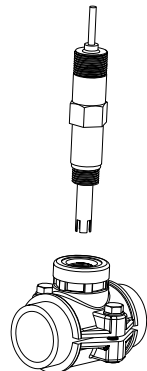

Installing Aspiration Filter

The aspiration filter is used in the reagent tank to filter and prevent debris from entering the tubing.

- Cut required length of aspiration tubing (flexible) to reach between peristaltic pump inlet and aspiration filter.
- Place the end of tubing on the filter.
- The compression fitting has to be screwed until secured on the filter.
- Slide the compression fitting from the peristaltic pump inlet onto the tubing.
- Slide the end of tubing over the fitting of the peristaltic pump tubing.
- Slide compression fitting up over tubing.
- Tighten the fitting.

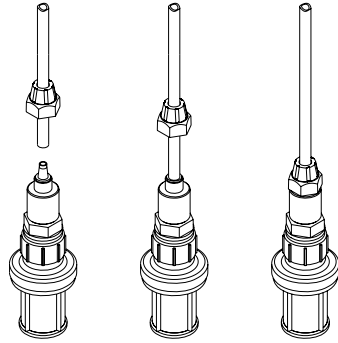

Installing Injector

- Cut the required length of dispensing (rigid) tubing to reach between injector saddle and outlet of peristaltic pump.
- Place the compression fitting nut on the tubing.
- Place the end of tubing on the injector.
- The compression fitting has to be screwed until secured on the injector.
- Screw the injector in the saddle.
- Slide compression fitting from pump tubing onto tubing.
- Slide the end of tubing over fitting of pump tubing.
- Slide compression fitting over tubing.
- Secure and tighten the fitting.

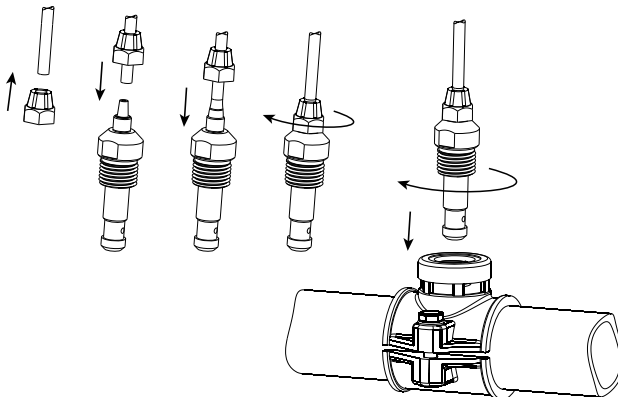

Flow Cell Installation

In a flow cell configuration, the water flows from the inlet valve to the flow cell and returns in the line via the outlet valve.

To prepare the inlet and outlet valve assemblies, as illustrated in the drawing:

- Mount the saddle for flow cell inlet and outlet valve, follow mounting recommendations for saddle.
- Sparingly lubricate two O-rings (2) with a thin film of silicon grease and mount them on the nipple (1) on both sides.
- Screw the nipple in the saddle (3).
- Screw the valve (4) into the open end of the nipple mounted into the saddle. Make sure it is tight and the lever is forward facing so that it can be operated.
- Carefully screw the straight tubing fitting (5) into the valve, taking care not to damage the O-ring.
- Insert the tubing (6) in the straight tubing fitting (5).

1	Nipple
2	O-ring
3	Saddle
4	Valve
5	Tubing fitting
6	Tubing

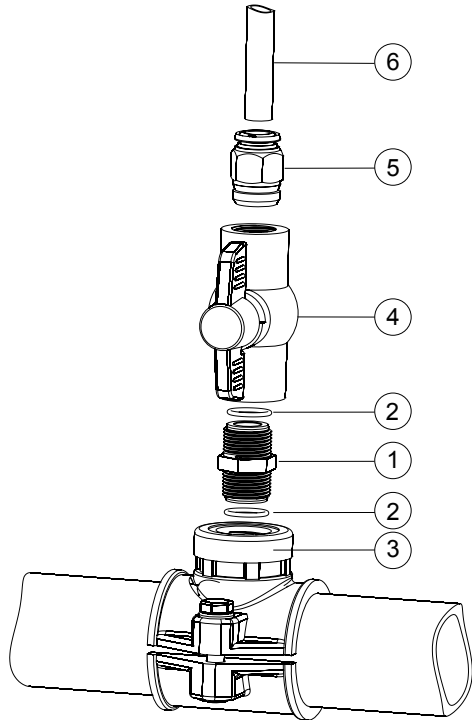

Connecting the Probe to the Flow Cell

- Remove the protective cap and verify if the O-ring (2) is in place.
- **Note:** The probe should be connected to the controller and calibrated before installation.
- To avoid twisting the cable, unplug probe from socket temporarily while installing in flow cell.
- Assemble the adapter fixing nut (4) with the flow cell O-ring (5) inside the adapter body (3). Tighten the adapter enough to seal in place and not damage the O-ring (5).
- Carefully insert the probe (1) into the flow cell adapter (3), paying attention not to damage the O-rings (2,5). Tighten the probe enough to seal in place.
- Cut the rigid PE tubing (9) to reach between flow cell inlet (bottom) and the pipe mounted outlet valve. Push the end of the tubing (9) into the tubing fitting (8).
- Repeat the previous step for flow cell outlet pushing the tubing (7) into the elbow tubing fitting (6).

1	Probe
2	Adapter O-ring
3	Adapter body
4	Adapter fixing nut
5	Flow cell O-ring
6	Elbow tubing fitting
7	Outlet rigid PE tubing 12 mm
8	Tubing fitting 12 mm
9	Inlet rigid PE tubing 12 mm

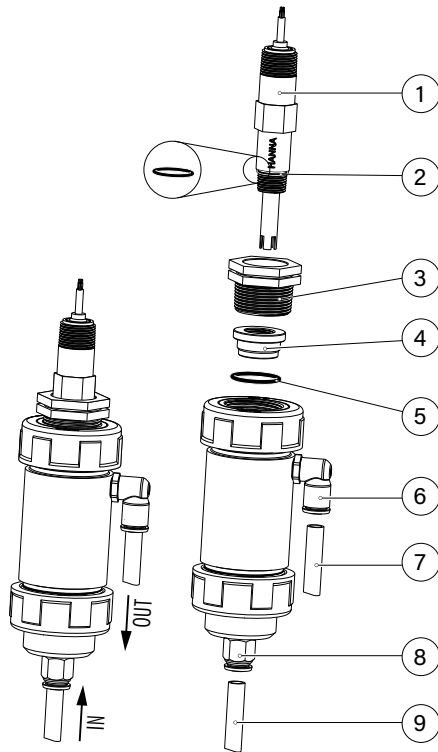

7. SETUP

- Short press MENU key to move to next item in menu.
- Long press MENU key to exit.
- Press arrow keys to change the values.
- Short press MENU key to automatically save modified values.

Table below presents an overview of the menu with ranges and factory set defaults.

Parameter (Scrolled Message)	Range / Option	Default Settings
Control	Auto or oFF	Auto
Control type	on/oFF or ProP (Proportional)	on/oFF
Control mode	Hi (High) or Lo (Low)	Lo (Low)
Measurement mode	EC or tdS	EC
Set point	0.10 to 10.00 mS/cm 45 to 9900 ppm (depends on TDS factor)	2.50 mS/cm 1250 ppm
Hysteresis (on/oFF only)	0.05 to 0.50 mS/cm 23 to 495 ppm (depends on TDS factor)	0.10 mS/cm 50 ppm
Band (Proportional only)	0.05 to 1.00 mS/cm 23 to 990 ppm (depends on TDS factor)	0.10 mS/cm 50 ppm
Start up delay (seconds)	0 to 600	60
Overtime alarm (minutes)	oFF, 1 to 180	30
Flow rate (Liter/hour)	0.5 to 3.5	1.0
Flow rate (Gallon/hour)	0.13 to 0.92	0.26
Level alarm	diS (disabled) or En (enabled)	diS (disabled)
High alarm	diS (disabled) or En (enabled)	diS (disabled)
High alarm value	0.10 to 10.00 mS/cm* 10 to 9900 ppm (depends on TDS factor)*	9.50 mS/cm 4750 ppm
Low alarm	diS (disabled) or En (enabled)	En (enabled)
Low alarm value	0.00 to 9.90 mS/cm* 0 to 9890 ppm (depends on TDS factor)*	0.50 mS/cm 250 ppm
TDS factor (TDS mode only)	0.45 to 0.99	0.50
Temperature coefficient	0 to 2.4% / °C	1.9% / °C
Temperature unit	°C or °F	°C
Flow rate unit	L.H (Liter/hour) or GAL.H (Gallon/hour)	L.H (Liter/hour)

Parameter (Scrolled Message)	Range / Option	Default Settings
Language	En (English), ES (Spanish), Fr (French), Pt (Portuguese), nL (Dutch), dE (German)	En (English)

*Available range changes based upon other settings.

High alarm must be set higher than low alarm. If low alarm was set 5.00 mS/cm (2500 ppm for 0.5 TDS factor) then high alarm range is 5.10 to 10.00 mS/cm (2510 to 9900 ppm, respectively).

Control

Option: Auto to enable or Off (oFF) to disable the control

Press one of the arrow keys for the controller settings to change from Auto to oFF and vice versa. To run a ten-seconds pump test, long press the arrow keys together until the pump starts to run. "CONTROL" message is scrolled on the bottom of the LCD screen.

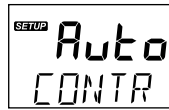

Control Type

Option: On Off (on/oFF) or Proportional (ProP)

Press the arrow keys to switch between on/off and proportional options. "CONTROL TYPE" message is scrolled on the bottom of the LCD screen.

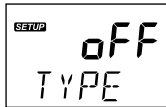

Note: To enter Control Type screen, pump control mode must be set as Auto.

Control Mode

Option: Low (Lo) mode or High (Hi) mode

Press the arrow keys to switch between the options. "CONTROL MODE" message is scrolled on the bottom of the LCD screen.

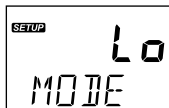

Note: To enter Control Mode screen, pump control mode must be set as Auto.

For more information see AUTOMATIC CONTROL TYPES in PUMP CONTROL section.

Measurement Mode

Option: Electrolytic Conductivity (EC) or Total Dissolved Solids (tdS)

Measurement units will be mS/cm for EC and ppm for TDS measurements.

Press the arrow keys to switch between the options.

“MEASURE MODE” message is scrolled on the bottom of the LCD screen.

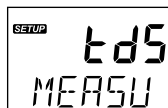
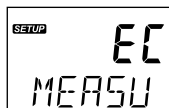

Set point

General: a set point is a threshold value that will trigger control if the measurement value crosses it.

With a Hi control mode, the measurement approaches the set point from a higher measurement value.

With a Lo control mode, the measurement approaches the set point from a lower measurement value than the set point.

Option: user selectable

Press the arrow keys to assign the set point value.

“SET POINT” message is scrolled on the bottom of the LCD screen.

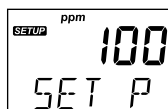

Note: To enter Set point screen, pump control mode must be set as Auto.

Hysteresis / Proportional Band

Hysteresis (On/Off control only)

On/Off control action turns the dosing On or Off based on a previously assigned set point. The pump status (running or not running) changes depending on EC changes. To prevent oscillation, an EC band, called hysteresis, is created between the on and off operations.

The pump starts dosing when the measurement crosses the set point value. The pump stops dosing when the measurement crosses the set point value \pm hysteresis band.

In order to set the hysteresis value, automatic control must be enabled, with On/Off control type On.

Proportional band (Proportional control only)

The proportional band is a control variable and is defined as the amount of change in input, required to cause the control output to go through 100% of operating range.

In order to set the proportional band value, automatic control must be enabled, with Proportional control type on. The pump is continuously on at the set point value with added band.

Option: user selectable

Press the arrow keys to set the value.

“HYSTERESIS” or “PROPORTIONAL BAND” message is scrolled on the bottom of the LCD screen.

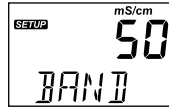
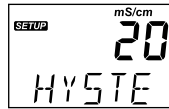
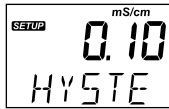

Note: To enter Hysterisis / Band screen, pump control mode must be set as Auto.

Startup Delay (Automatic Control Only)

Option: user selectable (0 to 600s)

Startup delay represents the delay to start dosing at power-on.

Press the arrow keys to change the time values.

“STARTUP DELAY SEC” message is scrolled on the bottom of the LCD screen.



Note: To enter Startup Delay screen, pump control mode must be set as Auto.

Overtime Alarm

Option: user selectable (off, 1 to 180 minutes)

Press the arrow keys to change the time values.

To disable the alarm, select Off.

“OVERTIME ALARM MIN” message is scrolled on the bottom of the LCD screen.

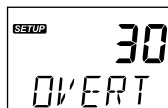

Note: To enter Overtime alarm screen, pump control mode must be set as Auto.

Flow Rate

Option: selectable (0.5 to 3.5 L/hour, 0.13 to 0.92 G/hour)

Press the arrow keys to change the values.

When in On/Off automatic control mode, the displayed value represents the actual flow rate.

When in Proportional automatic control mode, the displayed value represents a 100% flow rate.

“FLOW RATE L/H” or “FLOW RATE G/H” message is scrolled on the bottom of the LCD screen.

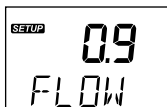

Level Alarm

Option: Enabled (En) or disabled (diS)

Press the arrow keys to switch between the options.

“LEVEL ALARM” message is scrolled on the bottom of the LCD screen.

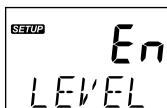
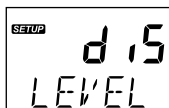

Note: Option can only be used with properly wired level sensor.

High Alarm

Option: Enabled (En) or disabled (diS)

Press the arrow keys to switch between the options.

“HIGH ALARM” message is scrolled on the bottom of the LCD screen.

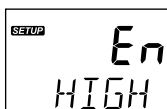
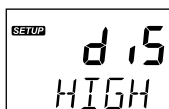

High Alarm Value

Option: user selectable

The range is influenced by the low-alarm value set (e.g. if low-alarm value is set as 5.00 mS/cm, high-alarm value can be set from 5.10 mS/cm and incremented up to 10.00 mS/cm).

“HIGH ALARM VALUE” message is scrolled on the bottom of the LCD screen.

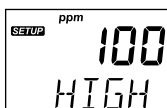

Note: The user can set the high-alarm value with high-alarm option enabled only.

Low Alarm

Option: Enabled (En) or disabled (diS)

Press the arrow keys to switch between the options.

“LOW ALARM” message is scrolled on the bottom of the LCD screen.

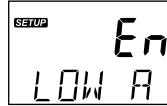
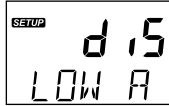

Low Alarm Value

Option: user selectable

The range is influenced by the high-alarm value set (e.g. if high-alarm value is set as 8.00 mS/cm, low-alarm value can be set from 0.10 mS/cm and incremented up to 7.90 mS/cm).

“LOW ALARM VALUE” message is scrolled on the bottom of the LCD screen.

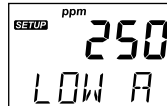

Note: The user can set the low-alarm value with low-alarm option enabled only.

TDS Factor

Option: TDS factor may be set between 0.45 to 0.99.

Press the arrow keys to change the value.

TDS factor is a conversion factor that is used to change an EC measurement to a ppm measurement. Common factors used in the hydroponic industry are 0.5 and 0.7. Consult Nutrient manufactures literature to determine the setting for this factor. 0.5 is based upon a sodium chloride solution. 0.7 is based upon a Potassium chloride solution.

“TDS FACTOR” message is scrolled on the bottom of the LCD screen.

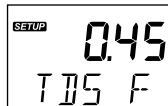

Note: The user can set the TDS factor value with Measurement Mode option set to tdS only.

Temperature Coefficient

Option: The coefficient can be set between 0 to 2.4% / °C.

A coefficient of 0.0%/°C is absolute conductivity.

Press the arrow keys to change the values.

“TEMPERATURE COEFFICIENT” message along with the set temperature unit is scrolled on the bottom of the LCD screen.

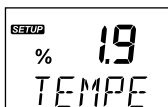

Temperature Unit

Option: °C or °F

Press the arrow keys to change the unit.

“TEMPERATURE UNIT” message is scrolled on the bottom of the LCD screen.

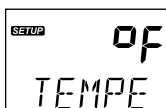
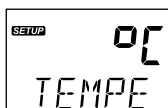

Flow Rate Unit

Option: Liter/hour (L.H) or Gallon/hour (GAL.H)

Press the arrow keys to switch between the options.

“FLOW RATE UNIT” message is scrolled on the bottom of the LCD screen.

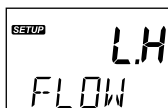

Languages

Option: Select from: En (English), ES (Spanish), Fr (French), Pt (Portuguese), nL (Dutch), dE (German)

Press the arrow keys to change the language.

“LANGUAGE” message is scrolled on the bottom of the LCD screen.



Note: “LANGUAGE” message, scrolled on the second line, is translated into the selected language.

8. PUMP CONTROL

Pump control can be enabled, automatic control (AUTO) or disabled (off).

See SETUP section for further details on how to enable or disable pump control.

LCD backlight color indicates the pump control status:

- green - automatic control or in View menu mode
- yellow - disabled or in Edit menu mode

On the LCD screen, the pump status is displayed as below:

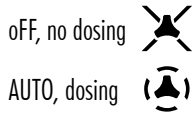

Startup Delay (Automatic Control Only)

When Startup Delay option is enabled, the controller is in Control Off mode for the set time; and the LCD backlight color is yellow. The delay countdown will start upon powering the controller. At the end of the timing the LCD backlight turns green and the control mode is automatic (Auto).

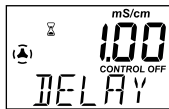

8.1. AUTOMATIC CONTROL TYPES

There are two automatic control types: On/Off (constant) control and Proportional control.

On/Off Control

With On/Off control type enabled in SETUP, the algorithm uses only “set point” and “hysteresis”, both with user-selectable values. See SETUP section for further details.

Low control mode: When the process EC drifts down and it reaches a low set point, it triggers the dosing pump to turn on and fertilizer solution can be added to increase the EC. The pump will remain on until the EC has increased to the set point value plus the hysteresis value. Then the pump will shut off.

High control mode: Conversely, with High control mode, the process EC drifts upward until it reaches a high set point. This triggers the dosing pump to turn on and a solution (purified water) can be added to decrease the conductivity. The pump will remain on until the EC has decreased to the set point value minus the hysteresis value. Then the pump will shut off.

The typical application uses a low control point with the addition of a fertilizer solution to increase the EC value.

On/Off Control

Lo control mode on the HI981413

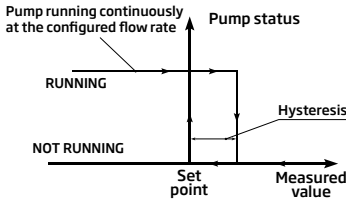

Hi control mode on the HI981413

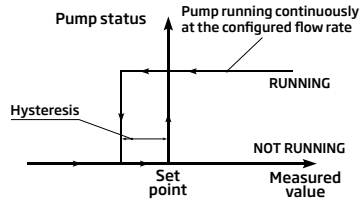

Proportional control

With Proportional control enabled in SETUP, the dosing time depends on the difference between measured EC value and assigned set point.

Proportional Control with Lo Control Mode and Band as illustrated

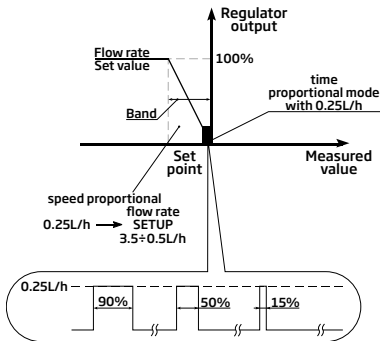

Proportional Control with Hi Control Mode and Band as illustrated

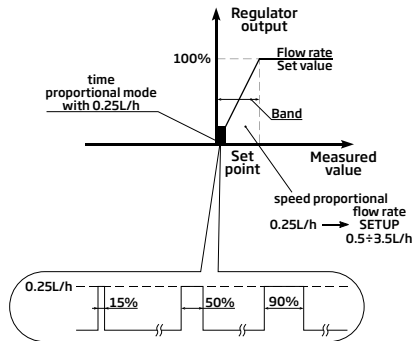

8.2. PRIMING THE PUMP

- From measurement mode, long press the arrow keys together to manually activate the pump.
- To exit, release the two keys.
- When there are no errors or active alarm, the LCD backlight is yellow.



9. EVENT MANAGEMENT

9.1. ALARMS

Alarms can be independently enabled or disabled in SETUP.

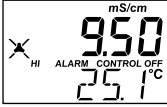

Any event that activates the alarm turns automatic control Off, the alarm relay is deactivated and the LCD backlight is blinking red.

The table below illustrates the conditions that will activate the alarm and deactivate the control pump.





Alarm	Description	Alarm condition	Solution
Overtime alarm	Pump remains on continuously for the time set in menu Overtime Alarm setting		Control is switched off. Pump is activated in Manual mode.
Hold level alarm	Low-level sensor active		Refill fertilizer solution container.
Low alarm	Measured EC / TDS is lower than the Low Alarm threshold value, for more than 5 seconds		Increase fertilizer content of process to acceptable values.
High alarm	Measured EC / TDS is higher than set threshold alarm High EC value, for more than 5 seconds		Decrease fertilizer content to acceptable values.

9.2. WARNINGS

Two types of warnings can be independently enabled or disabled in SETUP. If any of the warnings is active, the LCD backlight turns yellow.

Warnings	Description	Screenshot for warning solution	Terminate condition
Startup delay	Start up delay is active		Press the up / down arrows at same time to restart pump.
Control Off	Control is switched Off		Set Control setting to Auto.

9.3. SUMMARY OF GENERAL BEHAVIOR

Behavior	Control	Backlight	Alarm Output Relay
Control - auto	auto	green 	off
Warning active	off	yellow 	off
Error active	off	red 	on
Alarm active	off	red (blinking) 	on

10. CALIBRATION

10.1. EC CALIBRATION

The HI981413 provides a digital calibration at the push of a button. Calibrate the probe frequently for improved accuracy. Also:

- before in-line or flow cell installation
- whenever the probe is replaced
- after periodic maintenance

Always use fresh calibration solutions and perform electrode maintenance prior to calibration (see ELECTRODE CARE & MAINTENANCE section).

Preparation

Pour standard solution into clean beakers sufficient to cover the sensing portion of the probe (1 ½"). If possible, use plastic beakers to minimize any EMC interferences. For accurate calibration and to minimize cross-contamination, use two beakers, one for rinsing the probe and one for calibration.

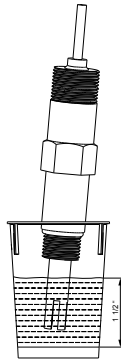

Procedure

- Raise and lower the probe in the standard to ensure the entire cell area is filled with standard.
- Shake any bubbles off the two electrodes (prongs),
- Center probe in beaker away from beaker walls.

Automatic One-Point Calibration

One-point calibration can be performed using one of the standard solutions: 1.41 or 5.00 mS/cm.

- Press CAL key to enter calibration mode. "mS/cm 1.41 USE" message is displayed as the calibration point. The value will change to 5.00 if that standard is used.
- The controller automatically recognizes the standard value.

- When the standard is recognized, "RECOGNIZED" is scrolled at the bottom of the LCD display. "WAIT" is displayed until the reading is stable and the calibration is accepted.



or

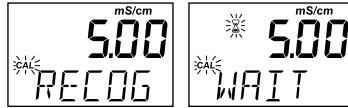

- If the standard solution is not recognized (either because the probe has not been placed in solution or the reading is outside accepted range), "---- WRONG" message is displayed along with CAL tag blinking.

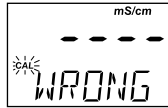

- After the standard solution is accepted, the "SAVE" message is displayed and the controller returns to measurement mode.



- The "CAL" tag is displayed automatically in measurement mode after a calibration has been performed.



10.2. PROCESS EC & TDS CALIBRATION

PROCESS EC CALIBRATION

Prior to performing a process EC or TDS calibration, determine the value using a reference meter. Make a note of the value.

Note: To enter process calibration, the "CAL" tag must be on. The controller and probe had to be calibrated previously in mS/cm standard.

EC process calibration is a single point calibration performed while the probe remains installed in the process. The value can be set ± 0.50 mS/cm around measured EC.

- Press CAL key to enter calibration mode. When the first standard solution value is displayed, press one of the arrow keys to enter process calibration.

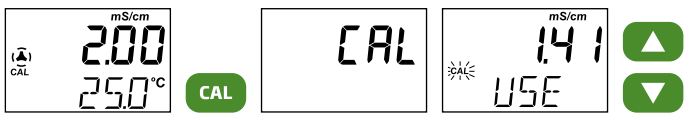

- Press the arrow keys again to adjust process calibration value to what was determined with the reference measurement. "PROCESS" message is scrolled on the bottom of the LCD screen.

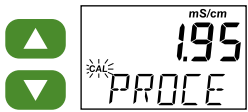

- Press CAL key to confirm the value (the "SAVE" message appears for a few seconds).
- Press MENU key to exit without saving and return to measurement mode. The "ESC" message is displayed for a few seconds.

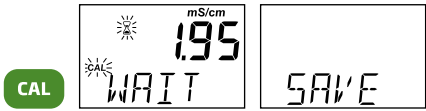

PROCESS TDS CALIBRATION

The probe may be calibrated in a TDS mode (ppm) prior to installation (in a standard) or it may also be calibrated while installed in the process by adjusting the value to that of a calibrated reference meter and probe.

- If calibrating in a beaker of standard, follow Preparation techniques in section 10.1 EC CALIBRATION.
- Follow the TDS process directions below to calibrate the probe and the controller.
- Wash with purified water before handling and installing into the control piping.
- Dispose of standard safely.

Verify probe is in a bubble-free solution or standard prior to calibration.

Note: The Cal tag must be on and the meter in TDS mode prior to making this calibration.

- Press CAL key to enter calibration mode. Use one of the arrow keys to enter TDS process calibration.



- Press the arrow keys to adjust the process calibration value to the value determined with the reference meter. "PROCESS" message is scrolled on the bottom of the LCD screen.

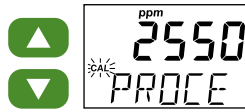

- Press CAL key to confirm the value. The "WAIT" message is followed by the "SAVE" message.
- Press MENU key to exit without saving and return to measurement mode. The "ESC" message is displayed for a few seconds.

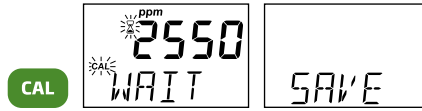

10.3. CLEAR CALIBRATION

- Press CAL key and the controller enters calibration mode.



- Long press MENU key and the "CLEAR" message is displayed.
- No "CAL" tag in measurement mode, indicates the probe is no longer calibrated.

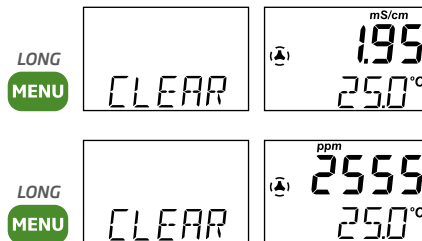

11. MEASUREMENT

- Power the controller. All LCD segments will be displayed for a few seconds. After initialization has been completed, the controller displays the measurement screen.
- Plug the probe into the dedicated socket using the alignment notch to install properly.
- The EC electrode is automatically recognized. If the wrong probe is used, the controller will indicate an error.
- After setting up the controller menu, probe and all required accessories, the controller is ready for measurement.
- From measurement mode, press both arrow keys simultaneously to prime the pump and to verify the flow cell fills correctly (if used).
- If power is lost, then restored, the controller keeps the last used settings and calibration.
- If control mode is enabled (Auto), the pump tag will be displayed. If control is disabled (oFF), the pump tag will be crossed out.

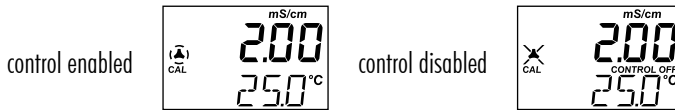

First LCD line displays measured EC / TDS value, the second LCD line displays the temperature. If a calibration was performed, the screen displays the CAL tag.

Measurements are updated every second and conditions are updated automatically. The pump starts or stops depending on configured settings (control mode and type, set point, hysteresis or proportional band, start up delay timer, overtime time, alarms).

12. ERROR MESSAGES

The pump controller shows error messages when erroneous conditions appear and when measured values are outside the expected range.

The information below provides an explanation of the errors, and recommended action to be taken. Error messages are displayed with red LED backlight.



Probe is not connected.
Connect the probe.

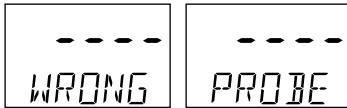

Wrong probe is connected.
Unplug the controller and ensure correct probe will be plugged in.

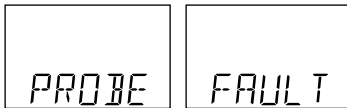

Broken temperature sensor.
Replace the probe.

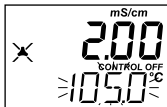

The temperature is out of range.

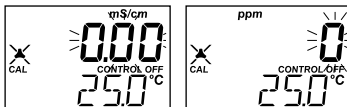

The EC or TDS measured value is out of range.



Stepper motor error: over temperature or overcurrent is detected.
When the error has ceased, the stepper motor resumes normal function.

13. MAINTENANCE

13.1. ELECTRODE CARE & MAINTENANCE

Proper care and maintenance of the conductivity probe is essential for accurate readings. Cleaning, calibrating, and appropriate storage will extend the life of the probe.

1. As preventative maintenance measure, rinse the probe with tap water on a weekly basis. Monthly, a more thorough cleaning is advised. Clean the EC sensor with a non-abrasive detergent, or refer to cleaning step 4 below.
2. Inspect the inside portion of the probe where the two electrodes (prongs) are. It should be free of foreign material.
3. If any solids are detected in this area, use a soft material such as Q-tip, to dislodge the material. Pass repeatedly the Q-tip between the two pins and inner surface. **DO NOT BEND PINS!**
4. Salt or mineral coating can be removed by rinsing it under a stream of running tap water and jetting the stream into the cell.
5. Shake excess water from the probe.
6. Recalibrate: place the probe into EC calibration standard. See section 10 MAINTENANCE.
7. The probe should be clean before is stored for any length of time. Clean the probe and place it into its box for storage.

13.2. PUMP TUBING REPLACEMENT

Note: While replacing tubing, wear protective gloves and eye protection at all times.

1. Power off the controller.

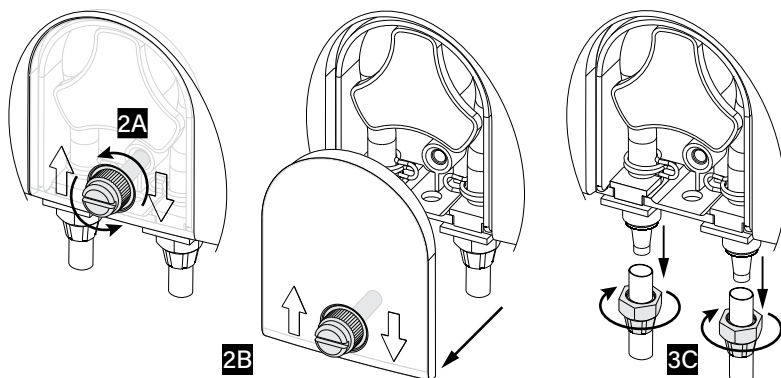

2. Remove the plastic screw securing the transparent cover (2A) and the cover (2B).
3. Disconnect the tubing from the pump (3C).
4. Starting from the left side of the pump, grab the peristaltic pump tubing (4A) and rotate the pump rotor manually to the right (4B), until the tubing is removed (4C).
5. Grease the new peristaltic pump tubing with silicone oil supplied in the peristaltic pump tubing kit (BL100-300).

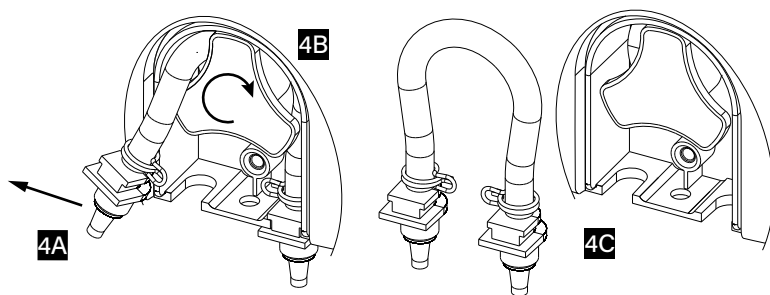

- Place the greased new peristaltic tube on the left side of the pump (6A) and rotate the pump rotor manually to the right (6B) until the tubing is on the pump. Fix the plastic holders on both sides (6C).

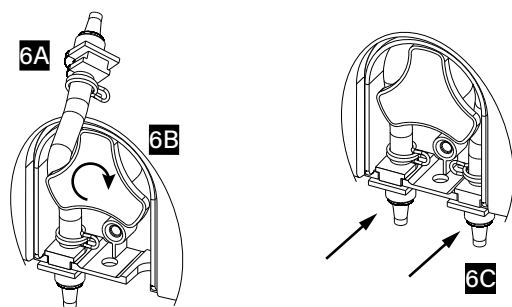

- Reattach the transparent plastic cover (7A) and secure it in place with the plastic screw (7B).
- Reattach the tubing to the pump (8C).

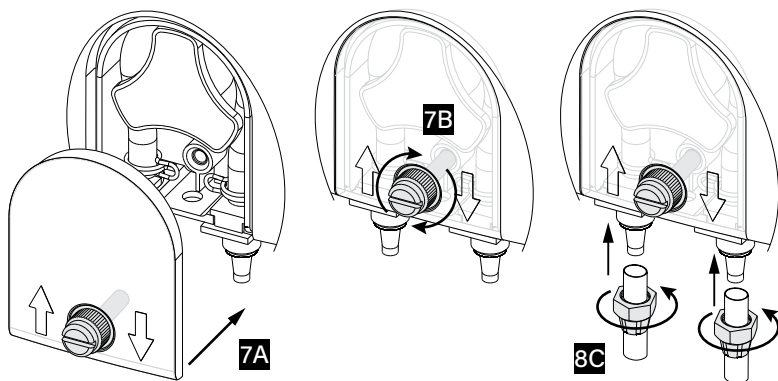

14. ACCESSORIES

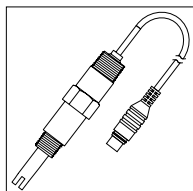

HI30033 EC/TDS/
temperature probe
with 2 m cable,
DIN Quick connect

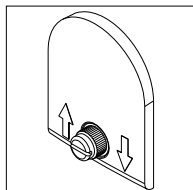

BL100-302
Pump cover
with screw

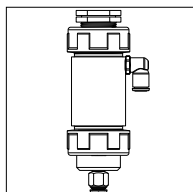

BL120-410
Flow cell for
HI981412

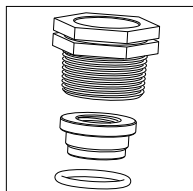

BL100-400
Probe adapter kit
(contains adapter,
fixing nut, O-ring)

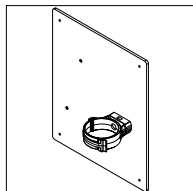

BL100-421
Flow cell panel

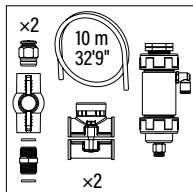

BL120-450
Flow cell kit for
Ø 50 mm pipe

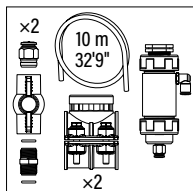

BL120-463
Flow cell kit for
Ø 63 mm pipe

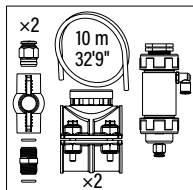

BL120-475
Flow cell kit for
Ø 75 mm pipe

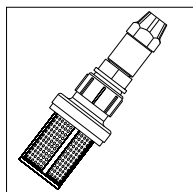

BL120-200
Controller aspiration
filter

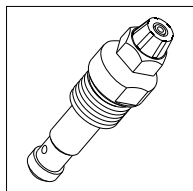

BL120-201
Controller injector,
1/2" thread

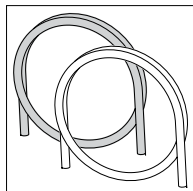

BL120-202
Aspiration and
dispensing tubing
5 m (2 pcs.)

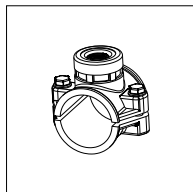

BL120-250
Injector saddle for
Ø 50 mm pipe, 1/2"
thread

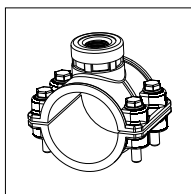

BL120-263
 Injector saddle for
 Ø 63 mm pipe,
 ½" thread

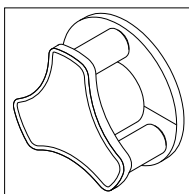

BL120-301
 Peristaltic pump rotor

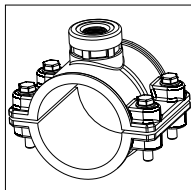

BL120-275
 Injector saddle for
 Ø 75 mm pipe,
 ½" thread

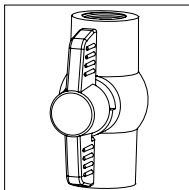

BL120-401
 Flow cell valve

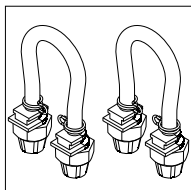

BL100-300
 Peristaltic pump
 tubing kit (2 pcs.)

Other Accessories

HI7031-012	1413 $\mu\text{S}/\text{cm}$ (1.41 mS/cm) solution (Groline), 120 mL
HI7031-023	1413 $\mu\text{S}/\text{cm}$ (1.41 mS/cm) solution (Groline), 230 mL
HI7039-023	5000 $\mu\text{S}/\text{cm}$ (5.00 mS/cm) solution (Groline), 230 mL
HI7031-050	1413 $\mu\text{S}/\text{cm}$ (1.41 mS/cm) solution (Groline), 500 mL
HI740036P	Plastic beaker set, 100 mL (10 pcs.)

CERTIFICATION

All Hanna Instruments conform to the **CE European Directives**.



Disposal of Electrical & Electronic Equipment. The product should not be treated as household waste. Instead hand it over to the appropriate collection point for the recycling of electrical and electronic equipment which will conserve natural resources. Ensuring proper product disposal prevents potential negative consequences for the environment and human health. For more information, contact your city, your local household waste disposal service, the place of purchase.



RECOMMENDATIONS FOR USERS

Before using this product, make sure it is entirely suitable for your specific application and for the environment in which it is used. Any variation introduced by the user to the supplied equipment may degrade the controller's performance. For yours and the controller's safety do not use or store the controller in hazardous environments.

WARRANTY

The HI981413 is warranted for two years (probes for six months) against defects in workmanship and materials when used for its intended purpose and maintained according to instructions. This warranty is limited to repair or replacement free of charge. Damage due to accidents, misuse, tampering or lack of prescribed maintenance is not covered.

If service is required, contact your local Hanna Instruments office. If under warranty, report the model number, date of purchase, serial number (engraved on the bottom of the meter) and the nature of the problem. If the repair is not covered by the warranty, you will be notified of the charges incurred. If the instrument is to be returned to Hanna Instruments, first obtain a Returned Goods Authorization (RGA) number from the Technical Service department and then send it with shipping costs prepaid. When shipping any instrument, make sure it is properly packed for complete protection.

Hanna Instruments reserves the right to modify the design, construction or appearance of its products without advance notice.

World Headquarters

Hanna Instruments Inc.
Highland Industrial Park
584 Park East Drive
Woonsocket, RI 02895 USA
www.hannainst.com



MAN981413

Printed in ROMANIA