



USER MANUAL

iLogic8 UV + Far Red



iLogic8 UV + Far Red

1-877-540-5588
iluminarlighting.com
sales@iluminarlighting.com



- Pre-Install Information 2
- Technical & Physical Specifications 3
- Hardware & Accessories 4
- Connection Instructions 5
- Hanging Installation 6
- Cable Logic Instructions 7-9
- Important Cautions & Warranty 10



MODEL:	iLogic8 UV+Far Red
VOLTAGE:	100-277V
WATTS:	630W
SKU:	IL-iLOGIC8-UVIR

TECHNICAL SPECS

Rated Voltage	120-277V AC
Voltage Range (+/-10%)	100-277V
Min Power Factor	0.95
THD	< 20%
Crest Factor	1.5
BTU	1200
Frequency	50 / 60Hz
Dimmable	0-10V
Ambient Temperature	0 - 35°C / 32-95°F
Max. Temperature	35°C / 95°F
Relative Humidity	85%
Color Temperature	3350k
Color Rendering Index	87
Minimum Mounting Height	8-12" to top of Canopy
Emitter Cooling	Passive / Extruded Case
Light Distribution	120°
Waterproof Rating	IP66 for Damp/Wet Conditions
LED Lifespan (90% of Life)	50,000+ hours



iLOGIC8 UV+FAR RED LED SPECTRUM

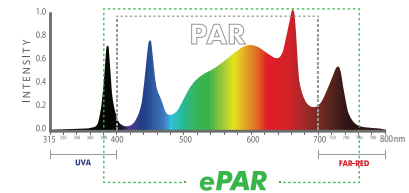

MOUNTING & COVERAGE

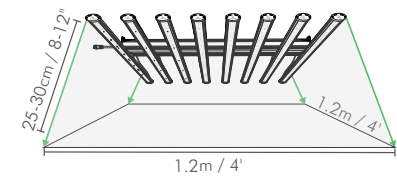

PHYSICAL SPECIFICATIONS

Length	1064mm	41.9"
Width	1002mm	39.4"
Height	124.3mm	4.9"
Weight	22.8kg	50.3lbs

VOLTAGE AND AMPERAGE

120V	5.7A	652W
208V	3.2A	632.5W
240V	2.8A	631W
277V	2.4A	630W

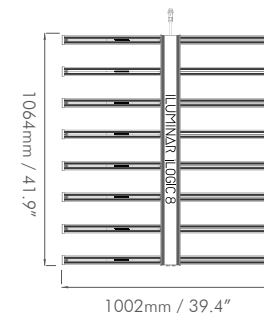

Please read this manual thoroughly prior to installing or operating the ILUMINAR iLOGIC8

- Observe all safety precautions (see page 10), seek the services of a qualified electrician, installation professional, or call ILUMINAR Lighting technicians for assistance.
- DO NOT handle or touch the fixture while in use.
- Connect the fixture only to the power sources of the appropriate voltage using the correct AC plug type. Protect power cables from being pinched, walked on, or otherwise damaged. Be especially careful where the power cable enters the power outlet to the unit. Only connect the fixture to an electrical outlet or extension cord of comparable standard and level rating. Connect the fixture ONLY to the power sources of the correct voltage using the plug received.
- The fixture should only be cleaned as directed. Always seek service for your system by qualified service personnel if any of the following occur:
 1. The fixture shows a noticeable change in performance.
 2. The powersupply cord or plug is damaged.
 3. The fixture has been dropped, or the exterior is damaged.

iluminarlighting.com
Toll Free: 1-877-540-5588



© Copyright 2021 ILUMINAR Lighting
Subject to change without notice.

HARDWARE AND ACCESSORIES

The iLogic8 can be hung from rope ratchets or can be mounted to a rack.

Before you begin installation, check that you have all the necessary parts to begin.

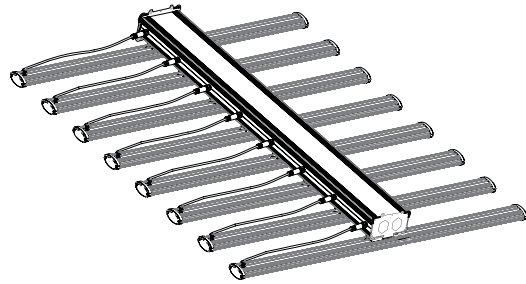

IN THE BOX

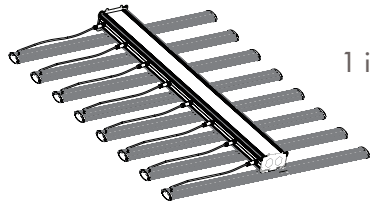

1 iLogic8 Fixture

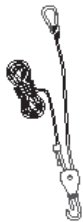

4 Rope Ratchets

CONNECTION INSTRUCTIONS

5

1

Lay the central mast on a flat table top or surface with the attachment brackets facing UP. Attach each LED Bar by aligning the plastic clips and carefully sliding them into place until you hear a soft click.

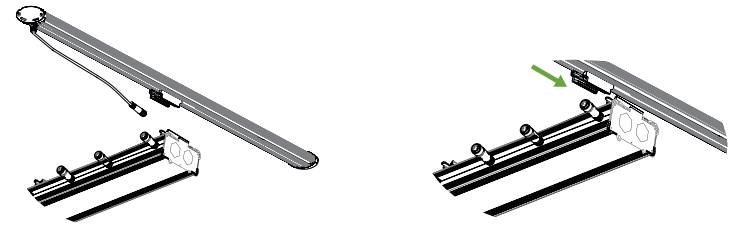

2

Once the plastic clips are all snapped in place, attach the A/C cables coming from the mast to each LED bar by aligning the connector pins and pressing the ends together. Lock by twisting in opposite directions.

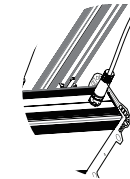

3

Once all the LED bars are fastened into place and A/C cables are attached to the mast, turn the fixture over (this may require more than one person). Ensure the flat surface is clear of anything that could damage the delicate diodes.



CAUTION when handling your ILUMINAR Fixture. The LED array should NOT come in contact with sharp objects. DO NOT touch diodes or apply direct force to the diodes as this can/will cause permanent damage.

HANGING INSTALLATION

1 To suspend mount, attach the 4 rope ratchets that come packaged with this fixture to the LED.

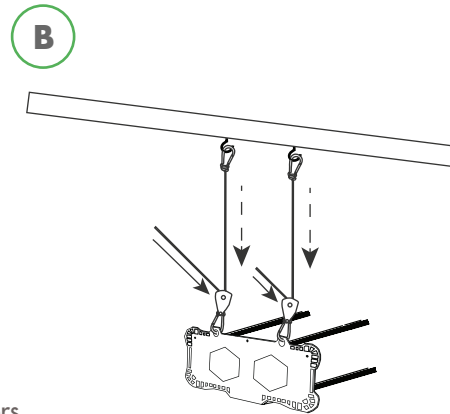
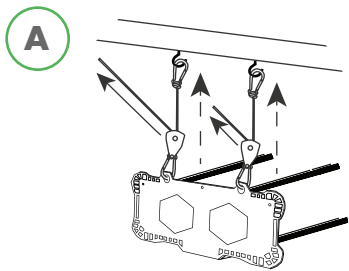

2 Lift the LED and attach the carabiners to pre-installed hooks from ceiling or mounting beam. The Ratchets should be installed closest to the LED (and not the ceiling).

A: Remove slack to raise fixture.
B: Give slack to lower fixture.

3 Once fixture is hanging with all LED bars installed, connect the power cable (blue tip) from the outlet to one side of the fixture.

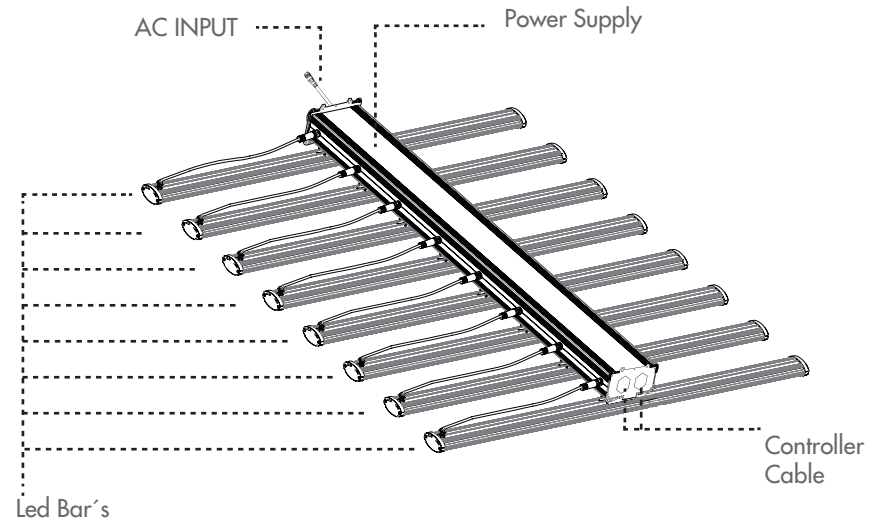
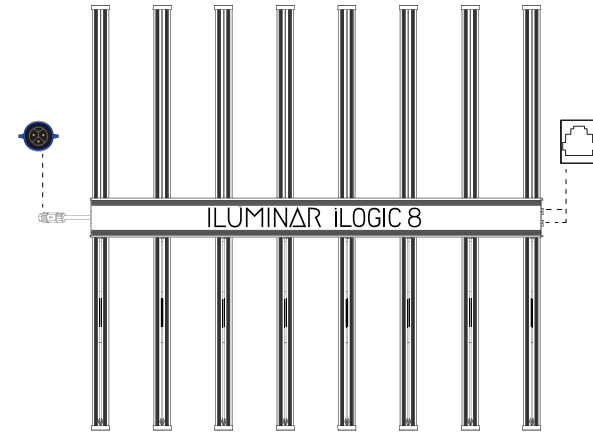

CABLE LOGIC CONNECTIONS

If you're planning to utilize several LEDs in your room or facility, one of the many benefits of the ILUMINAR LED is that you can "daisy chain" one fixture to another to save space and use only one outlet to run several lamps thus minimizing the amount of cords used in your space.

1 If you plan to utilize the ILUMINAR HASH Controller, you can connect the yellow connections from the controller to the fixture and then connect the Daisy Chain Controller Cable from fixture to fixture. Please consult with our lighting layout designers to ensure proper spacing of outlets for your unique setup.

	NAME	VOLTAGE	SKU	LENGTH	DIAGRAM
①	Cable Logic Main-Line AC Extension Cable 0.9m / 3ft 16A	120V-480V	IL-TML3	0.9m / 3ft	
	Cable Logic Main-Line AC Extension Cable 1.8m / 6ft 16A	120V-480V	IL-TML6	1.8m / 6ft	
	Cable Logic Main-Line AC Extension Cable 4.5m / 15ft 16A	120V-480V	IL-TML15	4.5m / 15ft	
②	Cable Logic Single Joint / Junction Main-Line AC Connector	120V-480V	IL-SJC	1.5m / 5ft	
	Cable Logic Multi Joint / Junction Main-Line AC Connector	120V-480V	IL-MJC	4.5m / 15ft	
③	Cable Logic Secondary AC Extension Cables 0.9m / 3ft 10A	120V-480V	IL-TS3	0.9m / 3ft	
	Cable Logic Secondary AC Extension Cables 1.8m / 6ft 10A	120V-480V	IL-TS6	1.8m / 6ft	
④	Cable Logic 120V AC Power	120V	IL-T120	0.25m/10"	
	Cable Logic 240V AC Power	240V	IL-T240	0.25m/10"	
	Cable Logic 277V AC Power	277V	IL-T277	0.25m/10"	
	Cable Logic 347V AC Power	347V	IL-T347	0.25m/10"	
	Cable Logic Panel Mount 20A - 480 VAC	480V	IL-PNLM	0.15m / 6"	
⑤	Cable Logic Dimming Cable 0.3m / 1.3ft	0-10V	IL-D1	0.3m / 1.3ft	
	Cable Logic Dimming Cable 0.9m / 3ft	0-10V	IL-D3	0.9m / 3ft	
	Cable Logic Dimming Cable 1.8m / 6ft	0-10V	IL-D6	1.8m / 6ft	
	Cable Logic Dimming Cable 3m / 10ft	0-10V	IL-D10	3m / 10ft	
	Cable Logic Dimming Cable 6m / 20ft	0-10V	IL-D20	6m / 20ft	

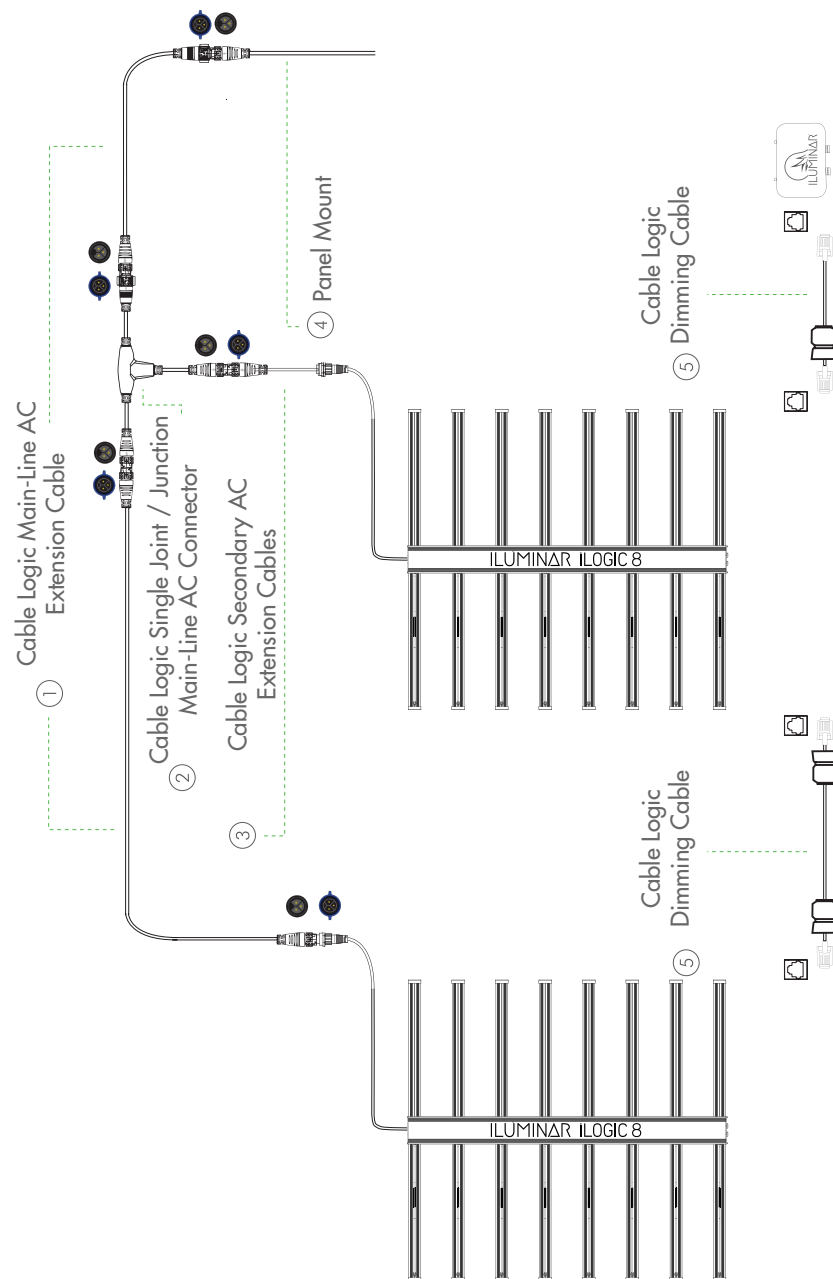

CAUTION

Please read the following list carefully prior to beginning installation.

1. Leave at least one inch of space between the fixture and the mounting area for maximum performance and lifespan.
2. ALWAYS wear protective eye wear when looking directly at the diodes to prevent eye damage.
3. Only handle, clean or move fixture when it's unplugged and completely cool.
4. Keep the fixture free of dust, debris, deposits to ensure the maximum potential of the fixture.
5. NEVER use cloth to clean the diodes. This will scratch the diodes and could potentially break or dislodge them.
6. DO NOT use chemicals to clean the fixture. Use ONLY low pressure air or low pressure water to remove dust and debris.
7. Do NOT exceed 70% max load for breakers due to Inrush current in LED fixtures.

5 YEAR
WARRANTY

GUARANTEE

At ILUMINAR, we stand behind our products and our technology as well as our customers. All ILUMINAR LED fixtures are backed by our 5-Year Guarantee. Please visit our website iluminarlighting.com/warranty for more information.