

SPYDRFANG

A high-performance LED grow light for craft cannabis cultivation. Enabling micro-growers to command their grow with an optimized 1600 $\mu\text{mol/s}$ (PPF) output, PhysioSpec™ Broad R4 spectrum, and included 0-100% dimmer for easy control and full-cycle cultivation.

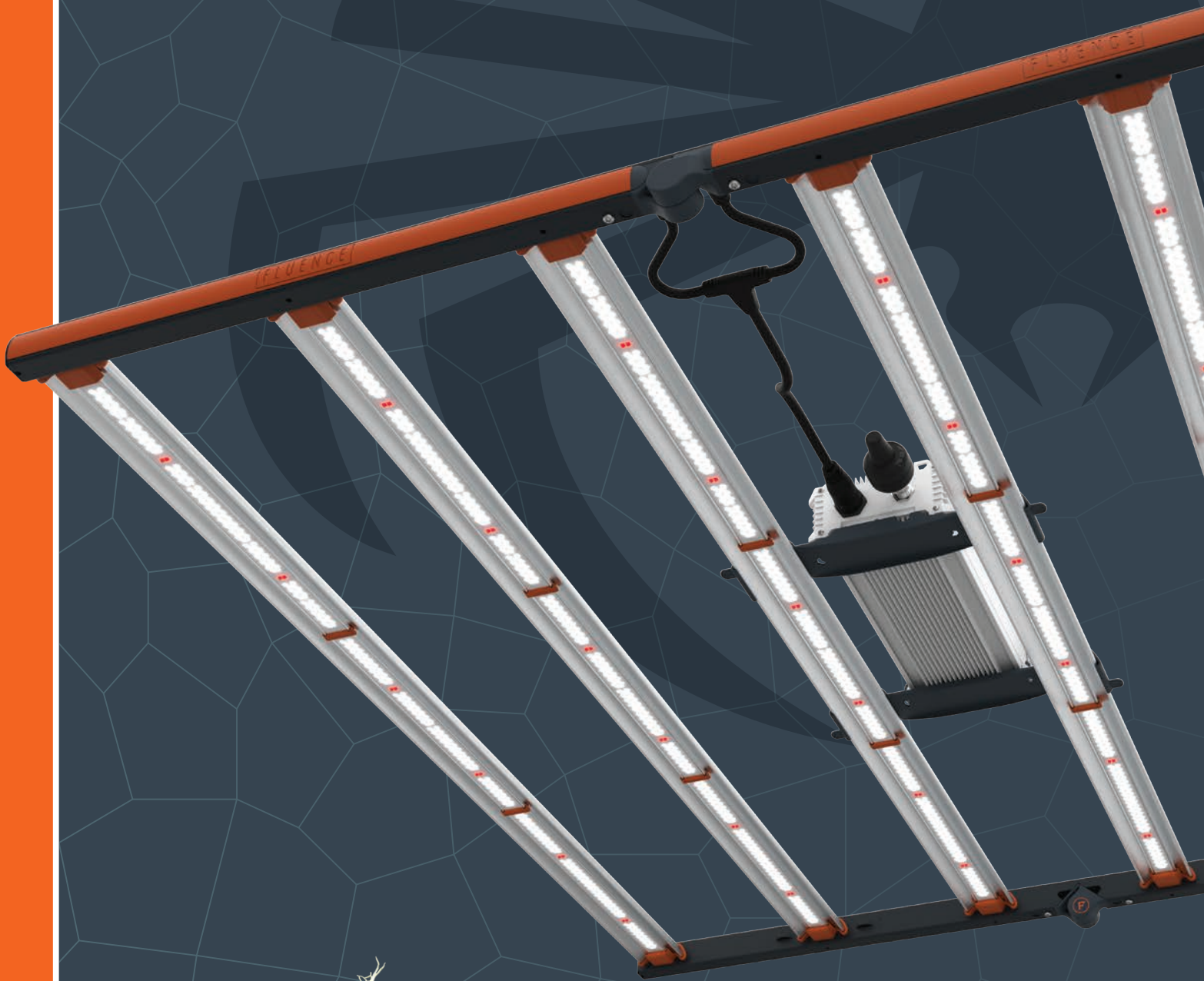

FLUENCE

SPECIFICATIONS

Light Source	LED
Spectrum	PhysioSpec™ Broad R4
Light Output PPF	1600 µmol/s
Efficacy	2.6 µmol/J @ 240 V AC
AC Input Power	626 W @ 240 V AC
AC Input Voltage	120-277 V AC, 50/60 Hz
Light Distribution	120°
Mounting Height Above Canopy	6" - 12" [15-30 cm]
Thermal Management	Passive
Max. Ambient Temperature/Humidity	95°F [35°C], 90% RH
Dimming	Dimmer Module Included
Total Harmonic Distortion (THD)	<10% at 100% output
Lifetime (Driver and LED Q90)	> 36,000 hrs
IP Rating per IEC60598-1	IP66
Certifications	UL 8800, UL 1598, CE, IEC60598-1
Warranty	3 Year Limited Warranty

NOMINAL ELECTRICAL AC INPUT*

AC VOLTAGE	120 V	230/240 V	277 V
AC Current	5.32 A	2.79 A	2.34 A
AC Power	636 W	626 W	625 W
Power Factor	0.99	0.97	0.96

* At 77°F [25°C] ambient temperature and 100% output.

ORDERING CODES

FAMILY	MODEL	SPECTRUM	INPUT VOLTAGE	DIMMER MODULE
SR	SPYDR 2R47	2R 47"x43" PhysioSpec™ Broad R4	LVG 120-277V	DM Dimmer Module for 0-100%

AC CABLE LENGTH	AC PLUG TYPE	MOUNTING HARDWARE	PACKAGING
06 6 ft (1,8 m)	N5P NEMA 5-15P N6P NEMA 6-15P TFP Schuko, CEE 7/7 ASP SAA Type I	M 2-Point Hanging Lances	S Single Pack

ALTERNATIVE AC POWER CABLES- AMERICAS (Order seperately)	Ordering Code
6 ft (1,8 m) AC Extension Cable, NEMA L7-15P Plug, M19 Push Lock, Max 277 V AC	CACA-70752-01
15 ft (4,6 m) AC Extension Cable, NEMA 5-15P Plug, M19 Push Lock, Max 125 V AC	CACA-70749-01
15 ft (4,6 m) AC Extension Cable, NEMA 6-15P Plug, M19 Push Lock, Max 250 V AC	CACA-70751-01
15 ft (4,6 m) AC Extension Cable, NEMA L7-15P Plug, M19 Push Lock, Max 277 V AC	CACA-70753-01

ALTERNATIVE AC POWER CABLES- EUROPE (Order seperately)	Ordering Code
4,5 m (15 ft) AC Cable, H07RN-F, Schuko CEE 7/7 plug, M19 Push Lock, 230V AC	CACE-70775-01

SPECTRA

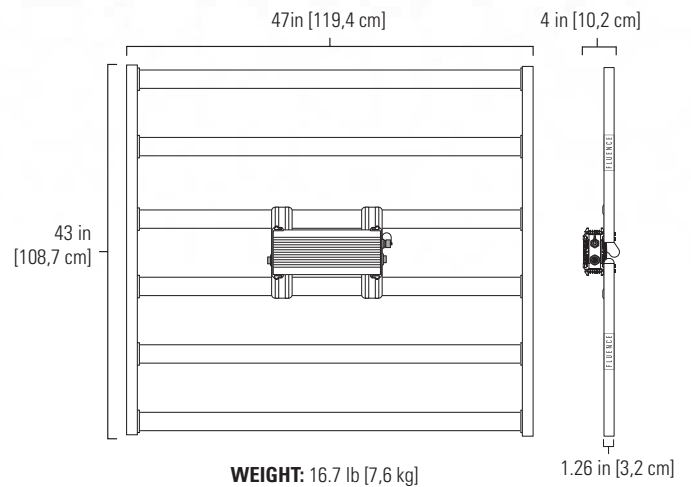
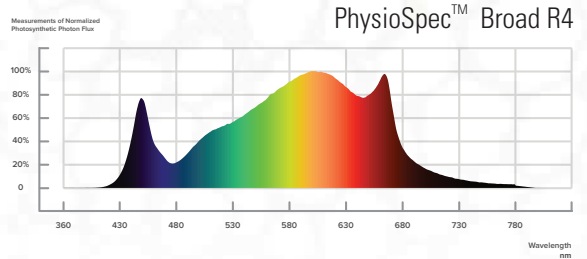

[MOUNTING HARDWARE]



[DIMMER MODULE]

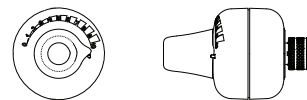

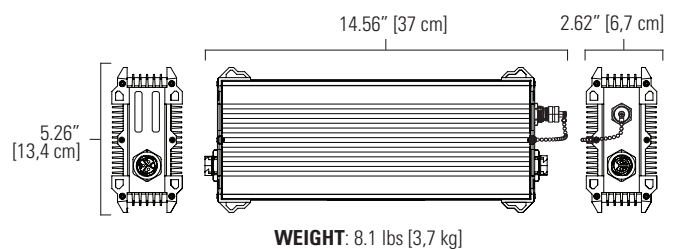

[PSU 120-277V AC]



Disclaimer: Performance values are from representative tests performed in accordance with industry standards listed. Actual application performance may vary due to component tolerances and installation, environmental, and field measurements conditions.



Contact **FLUENCE** 
 support@fluence.science 
 www.fluence.science 

© Copyright 2022 Fluence Bioengineering 2022-04
 Subject to change without notice
 Horticultural lighting | Not suitable for household illumination.