

AC INFINITY

CLOUDLINE A/B

MIXED FLOW INLINE FAN SYSTEMS

USER MANUAL

WELCOME

Thank you for choosing AC Infinity. We are committed to product quality and friendly customer service. If you have any questions or suggestions, please don't hesitate to [contact](#) us. Visit www.acinfinity.com and click contact for our contact information.

EMAIL

support@acinfinity.com

WEB

www.acinfinity.com

LOCATION

Los Angeles, CA

MANUAL CODE CLAB2109X1

PRODUCT

CLOUDLINE A4
CLOUDLINE A6
CLOUDLINE A8
CLOUDLINE B4
CLOUDLINE B6
CLOUDLINE B8

MODEL

AI-CLA4
AI-CLA6
AI-CLA8
AI-CLB4
AI-CLB6
AI-CLB8

UPC-A

819137021747
819137021754
819137021761
819137021778
819137021785
819137021792

MANUAL INDEX

| | |
|--|---------|
| Manual Index | Page 5 |
| Key Features | Page 6 |
| Product Contents | Page 7 |
| Installation (Mounting) | Page 9 |
| Installation (Hanging) | Page 14 |
| Installation (Motor Cap Orientation) | Page 18 |
| Installation (Configuration Setup) | Page 19 |
| Powering and Setup | Page 20 |
| Controller Mounting | Page 23 |
| Adding More Fans | Page 27 |
| Universal Infinity System | Page 28 |
| Cleaning | Page 29 |
| Programming | Page 31 |
| Other Settings | Page 42 |
| FAQ | Page 43 |
| Other AC Infinity Products | Page 45 |
| Warranty | Page 46 |

KEY FEATURES

QUIET PWM MOTOR

PWM-controlled motor features precise speed control, reduced rotor noise, and energy-efficient EC voltage.

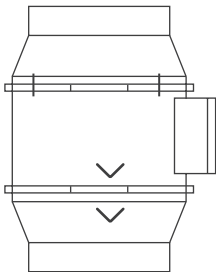

IP-44 PROTECTION

The inline duct fan is sealed to Ingress Protection 44 standards, rated with high resistance to liquids and dust.

STATOR BLADE FANS

Hydro-mechanical stator blades enable efficient airflow delivery in high static pressure environments.

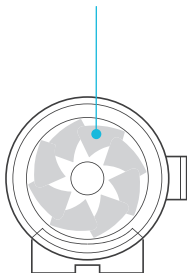

DUAL BALL BEARINGS

The motor contains ball bearings with an estimated 67,000 hour lifespan. Enables the fan to be mounted in any direction.

SMART CONTROLLER

Monitors temperature using included 6" probe. Features two UIS ports with climate triggers and timers.



*For B-Series Only



*For A-Series Only



SPEED CONTROLLER

Single button controller with circular dot display that enables fan speed control in ten speeds.

PRODUCT CONTENTS

CLOUDLINE A-Series



SPEED
CONTROLLER
(x1)



UIS F - 4PIN M
ADAPTER
(x1)



WOOD SCREWS
(WALL MOUNT)
(x1)

CLOUDLINE B-Series



SMART
CONTROLLER
(x1)



TEMP.
PROBE
(x1)

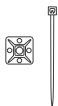

PROBE
MOUNT
(x1)



WOOD SCREWS
(WALL HANG)
(x2)

FAN UNIT (Included in both A-Series and B-Series)

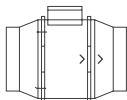

DUCT FAN
SYSTEM
(x1)



HANGING
STRAPS
(x2)



VELCRO
TIES
(x4)



WIRE
TIE
(x6)



CABLE TIE
MOUNT
(x6)



WALL
ANCHOR
(x4)



WOOD
SCREWS
(x6)



DUCT FAN
SCREW SET
(x4)

PRODUCT CONTENTS

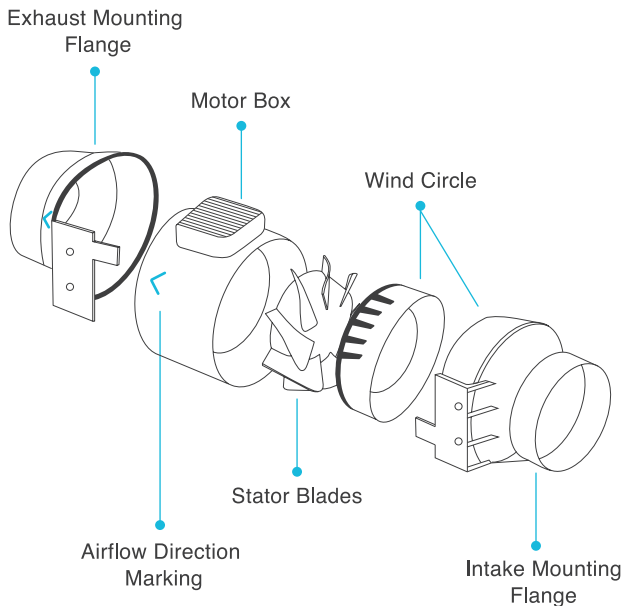

INSTALLATION

MOUNTING

STEP 1

Unscrew the bolts on both sides from the plastic rings using a Philips screwdriver.

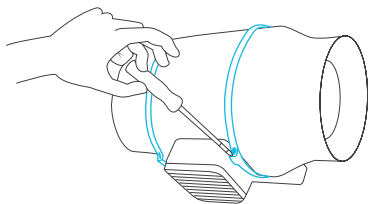

STEP 2

Remove the motor box from the flange bracket. Remove the wind circle between the motor box and the intake flange.

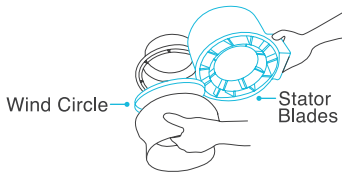
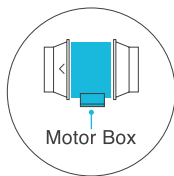

INSTALLATION

MOUNTING

STEP 3

Use the flange bracket to set your desired fan position. Mark the four mounting holes.

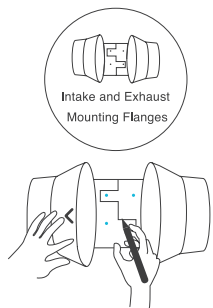

STEP 4

Drill four holes into the marked locations. Make sure your mounting area is structurally sound and free from obstruction.

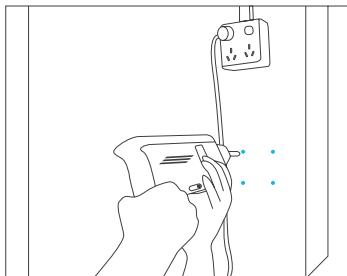

INSTALLATION

MOUNTING

STEP 5

If you are mounting onto anything other than a wood support or stud, insert the included four wall anchors into the drilled mounting holes. You may need to use a hammer to secure them through the holes.

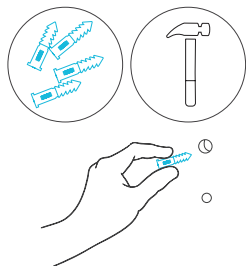

STEP 6

Align the flange bracket's holes with the wall anchors. Screw in four wood screws with a screwdriver or drill to secure the flange bracket.

Make sure its airflow arrow is pointing in your desired direction.

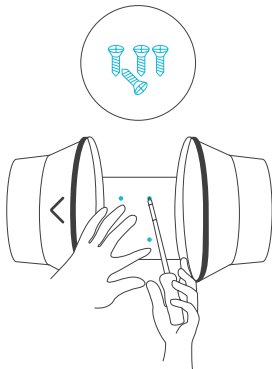

INSTALLATION

MOUNTING

STEP 7

Place the wind circle back into the intake flange.

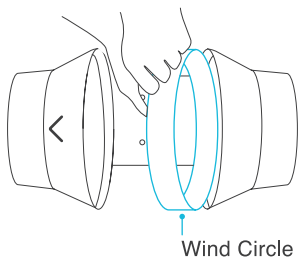

STEP 8

Slide the motor box back into the flange bracket, making sure its airflow arrow is pointing in the same direction as the flange bracket's arrow.

Screw the bolts back into the plastic rings to secure the motor box to the flange bracket.

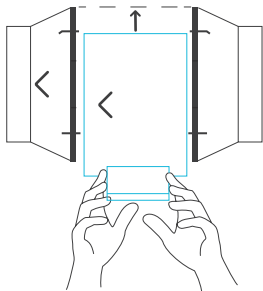

INSTALLATION

MOUNTING

STEP 9

If installing ducting, use the included duct clamps to secure it to either end of the duct fan, making sure there is a tight seal.

Tighten the duct clamps using a flathead screwdriver.

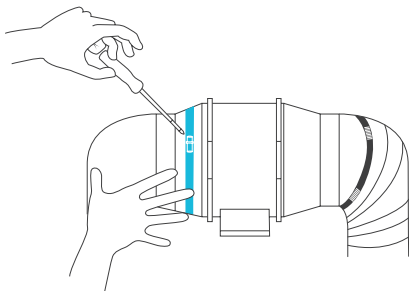

INSTALLATION

HANGING - ROPE CLIPS

STEP 10(a) - Hanging Upward

If installing with rope hangers (sold separately), loop the ropes around the flanges and tighten the rope to secure the fan.

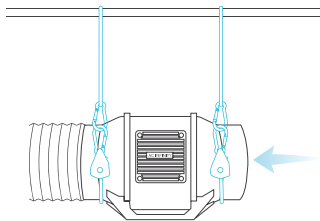

STEP 10(b) - Hanging Downward

Loop the two rope hangers around a pole and the fan's bracket.

Clip the carabiners onto each other. Shorten the loops as needed.

Make sure the fan's airflow arrow is pointing towards your desired direction.

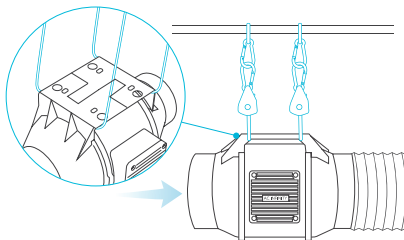

INSTALLATION

HANGING - STRAPS

STEP 1

Loop the strap around the bracket and a pole.

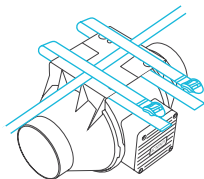

STEP 2

Slip the strap through the inner ladder lock slot from the bottom.

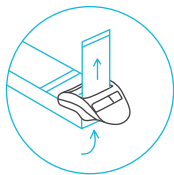

INSTALLATION

HANGING - STRAPS

STEP 3

Route the strap into the outer ladder lock slot from the top. Adjust the length of the completed loop as needed.

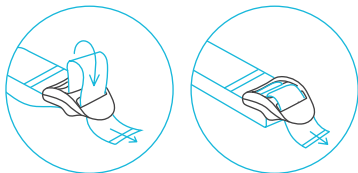

Adjust to size

STEP 4

Tuck the loose end through the center gap of the ladder lock to secure the loop.

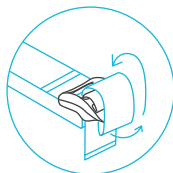

Loop through middle
to lock in place

INSTALLATION

HANGING - STRAPS

STEP 5(a) - Hanging Downward

Let the fan hang by the pole once the straps are secure.

Make sure the fan's airflow arrow is pointing towards your desired direction.

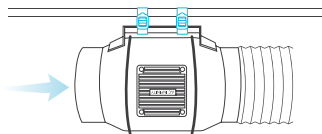

STEP 5(b) - Hanging Upward

To hang the fan right-side up, loop and tighten the straps, as shown in steps 1-4, around the pole.

Hang the fan by the duct flanges to secure it.

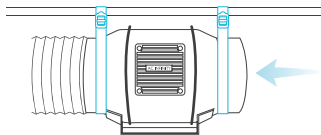

INSTALLATION

MOTOR CAP

STEP 1

Unscrew the motor cap using a screwdriver.

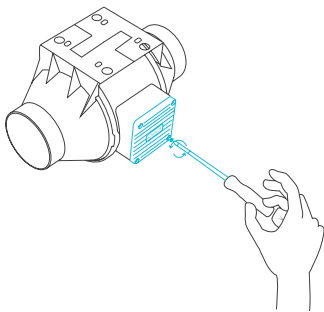

STEP 2

Rotate the motor cap to your desired orientation. Reapply the screws.

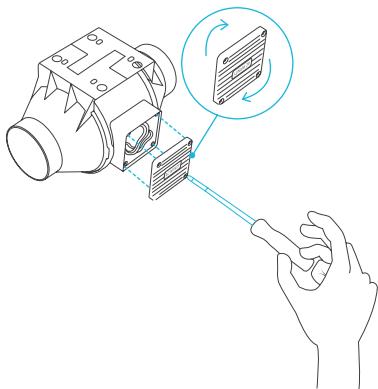

Rotating the motor cap will not void your warranty.

INSTALLATION

CONFIGURATION SET-UP

INTAKE AND EXHAUST

This fan can be used as either an intake fan or an exhaust fan in grow rooms and larger grow tents. To achieve optimal whole space ventilation, the intake fan or opening - if not using a fan - must be situated at a bottom corner of your grow space. The exhaust fan must be hung (shown below) or mounted at the highest opposite corner possible.

Make sure the intake fan's airflow arrow is pointing towards your grow space and the exhaust fan's arrow pointing away from your grow space.

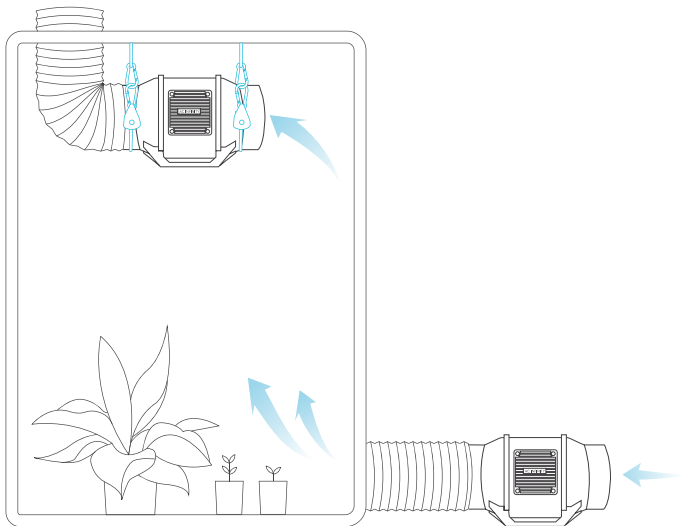

POWERING AND SETUP

A-SERIES

STEP 1

Plug the duct fan's UIS connector into the speed controller.

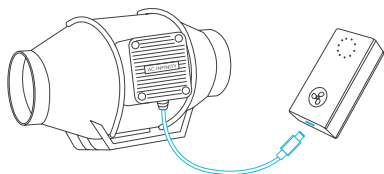

STEP 2

Plug the fan's power cord into an AC power outlet to power the fan and controller.

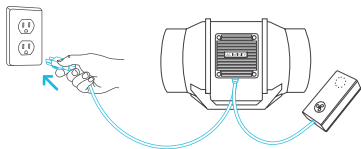

POWERING AND SETUP

B-SERIES

STEP 1

You may use the included tie mounts, wood screws, and zip ties to cable manage the cords.

Secure the tie mounts onto a surface using the wood screws. Loop the zip ties around the cords into the tie mounts.

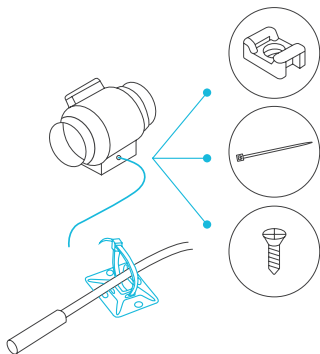

STEP 2

Plug the duct fan's UIS connector into the smart controller.

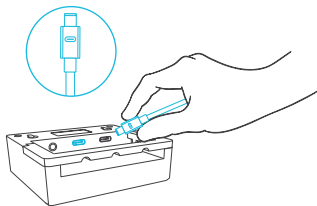

POWERING AND SETUP

B-SERIES

STEP 3

Plug the temperature probe into the controller's 3.5mm jack. Set the probe near your plants in your grow tent for the most accurate reading.

Keep the probe cord away from your HID* grow light ballast's power cord to ensure the controller properly detects climate conditions.

*MH, HPS, CMH, or CHPS

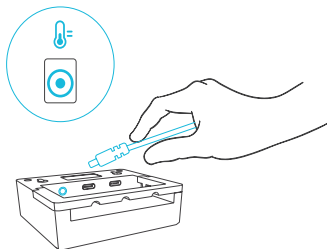

STEP 4

Plug the fan's power cord into an AC power outlet to power your fan and controller.

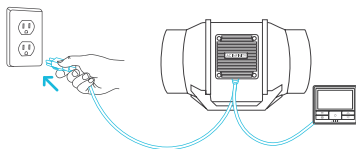

CONTROLLER MOUNTING

A-SERIES

MAGNET MOUNTING

Mount the controller using the magnet located on its backside.

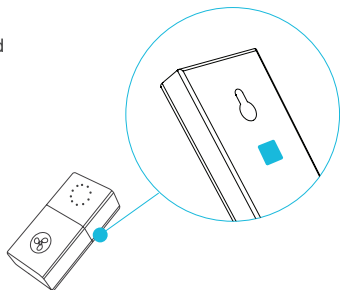

CONTROLLER MOUNTING

B-SERIES

STEP 1

Locate a spot free of obstruction and secure the anchors into your wall. Twist the wood screws into the anchors.

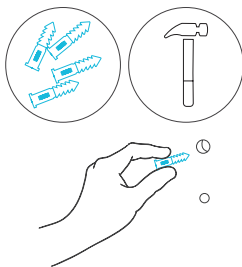

STEP 2(a)

Plug in your fan's UIS plug and sensor probe. Route the cords down through the kickstand's grooves.

Hang the device onto the screws using the holes on the backside of the controller.

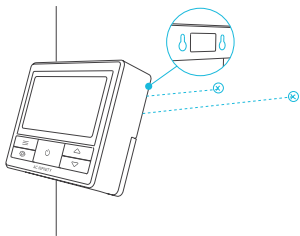

CONTROLLER MOUNTING

STEP 2(b)

Cords may be routed into or outside of the kickstand grooves, through a cut hole behind the controller.

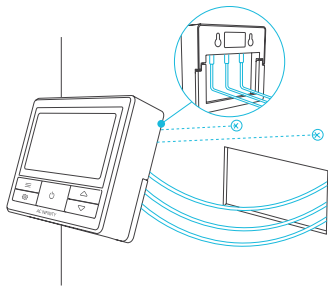

MAGNET MOUNTING

You may also mount the controller using the magnet located behind the label.

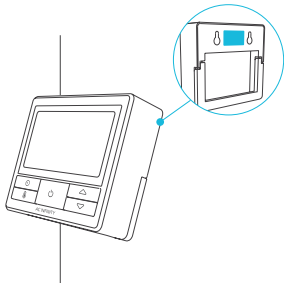

CONTROLLER MOUNTING

KICKSTANDING

Open the stand behind the controller to set it tilted on your desktop.

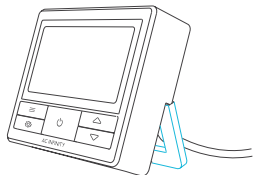

ADDING MORE FANS

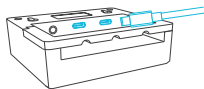

The smart controller for the CLOUDLINE B-Series has an additional port so that you can add an A-Series fan to power and control two fans together. Please see below for limitations.

B-SERIES CONTROLLER

Smart controllers for B-Series models with EC motors can support two fans of any size. The two EC-motor fans must be plugged in to an outlet to power the fans and controller. See image below.

Dual Connection

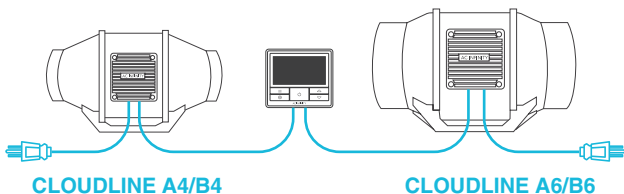

MOLEX ADAPTER

Use the included UIS to 4-pin Molex adapter to connect your fan to your T-Series controller. Plug your fan's UIS connector into the adapter. Then plug the adapter into your controller.

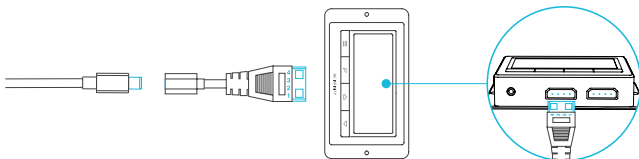

UNIVERSAL INFINITY SYSTEM

The Universal Infinity System enables you to connect a single central controller with several grow devices simultaneously. By creating this fully integrated system, you can power and program all your devices together or separately for optimized grow tent management.

Use select smart controllers to set triggers that will activate your devices based on your grow tent's temperature and humidity. Create independent timers and schedules for customized activation in your desired timeframe.

Your grow system can be regulated using your controller hub or remotely on the AC Infinity app (paired with compatible controllers), where you will have access to automation programming and climate data.

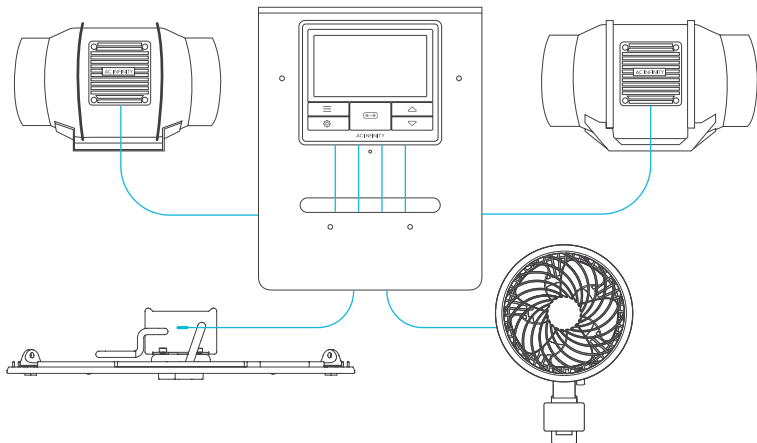

Central controllers and grow devices will be sold separately and may still be in development at the time of your purchase of this product.

CLEANING

STEP 1

Remove the motor box from the mounting flange. Refer to steps 1-2 on page 9 to learn how to remove the motor box.

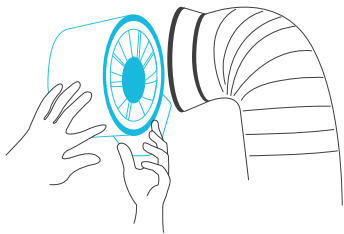

STEP 2

Use a damp cloth to clear the impeller and fan blades of any dust and debris. Remove the wind circle in between the motor box and input flange.



CLEANING

STEP 3

Clear the stator blades of any dust and debris on the opposite end. Clean the area inside the output and exhaust flanges.

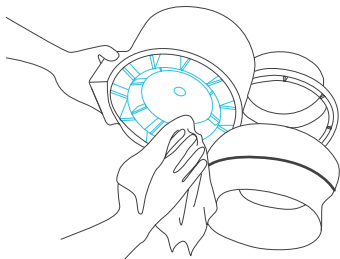

STEP 4

Secure the motor box onto the mounting flanges. Refer to steps 7-9 on page 12-13 to learn how to secure the motor box.

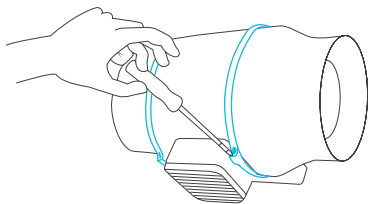

PROGRAMMING

A-SERIES

FAN SPEED ADJUSTING

The controller features a single button that controls the fan speed from 0-10. Pressing the speed button increases the fan speed in one unit increments. Pressing the button at the 10 setting will set the fan speed back to 0.

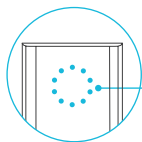
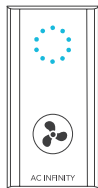

Fan Speed
Indicator

POWERING ON/OFF

Press the button to turn your fan on. Hold the button to turn your fan off. Pressing it again will turn the fan on at its last speed setting.

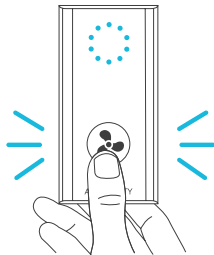

PROGRAMMING

B-SERIES

1. POWER BUTTON

Switches between the OFF and ON modes. Pressing this button will bring the controller to OFF mode.

4. UP/DOWN BUTTONS

Adjusts the value of your current mode. The up button increases and down button decreases the setting. Hold both to reset values to OFF or 0.

6. CONTROLLER MODE

Displays the controller's current mode. Pressing the mode button cycles through the available modes.

8. FAN SPEED

Displays the current speed in which the fan is running. Includes a trend indicator that signals if the fan is currently rising, falling, or holding steady.

2. MODE BUTTON

Cycles through the controller's modes: OFF, ON, AUTO TEMPERATURE (2 Triggers), TIMER to ON, TIMER to OFF, CYCLE (ON and OFF).

3. SETTING BUTTON

Cycles through the controller's settings: DISPLAY, F/C, CALIBRATION, and TRANSITION.

5. PROBE TEMP.

Displays the current temperature that the probe is detecting. Shows "--" if no probe is plugged in. Includes a trend indicator that signals a rise, steady, or fall in temperature within the last hour.

7. ALERT ICONS

Displays alerts and statuses of the controller, including the controller lock, CLIMATE alert, and TIMER alert.

10. USER SETTING

Displays the value you have set for the current mode you are in. Press the up or down button to adjust the value.

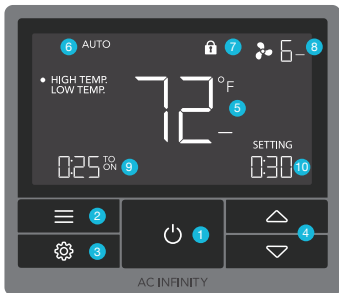

9. COUNTDOWN

Displays the countdown of the TIMER to ON, TIMER to OFF, or CYCLE mode activates or deactivates the fan. TO ON shows the amount of time left before the fan turns on. TO OFF shows the amount of time left before the fan turns off.

PROGRAMMING

POWER MODE SETTING

Pressing the power button will cycle between the controller's OFF Mode and ON Mode.

OFF MODE

Your fan will not run while in this mode. The fan speed set here establishes the minimum speed in the other modes. When the fan is triggered to turn OFF in all other modes, it will instead run at the speed set here.

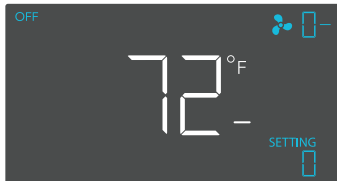

ON MODE

Your fan will actively run at the speed set here, regardless of the probe's reading. The ON mode also serves as the maximum speed setting the other modes will run in.

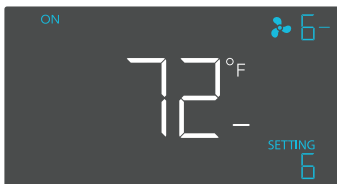

PROGRAMMING

CONTROLLER MODES

Pressing the mode button will cycle through the controller's available programming modes: OFF, ON, AUTO TEMPERATURE (2 Triggers), TIMER to ON, TIMER to OFF, and CYCLE (ON and OFF).

OFF MODE

Your fan will not run while in this mode. The fan speed set here establishes the minimum speed in the other modes. When the fan is triggered to turn OFF in all other modes, it will instead run at the speed set here.

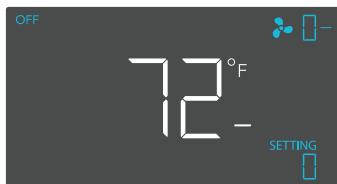

ON MODE

Your fan will actively run at the speed set here, regardless of the probe's reading. The ON mode also serves as the maximum speed setting the other modes will run in.

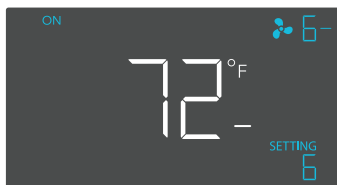

PROGRAMMING

AUTO MODE: HIGH TEMPERATURE TRIGGER

Pressing the up or down button sets the high temperature trigger. The fan will activate if the probe's reading meets or exceeds this threshold.

Once triggered, the fan will gradually ramp up to the speed set in ON mode. If the probe's reading falls below this trigger point, the fan will gradually slow down to a stop or at the speed set in OFF mode.

You may set this trigger below the low temperature trigger to create a specific range in which the fan is active.

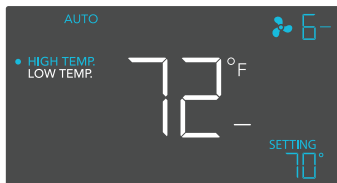

Note that this trigger can activate as long as you are in AUTO Mode, even if you are viewing a different trigger within AUTO Mode.

AUTO MODE: LOW TEMPERATURE

Pressing the up or down button sets the low temperature trigger. The fan will activate if the probe's reading meets or falls below this threshold.

Once triggered, the fan will gradually ramp up to the speed set in ON mode. If the probe's reading rises above this trigger point, the fan will gradually slow down to a stop or at the speed set in OFF mode.

You may set this trigger above the high temperature trigger to create a specific range in which the fan is active.

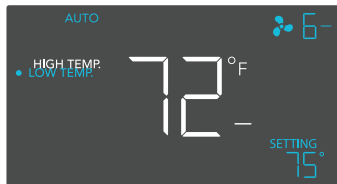

Note that this trigger can activate as long as you are in AUTO Mode, even if you are viewing a different trigger within AUTO Mode.

PROGRAMMING

TIMER TO ON MODE

Pressing the up or down button sets a countdown time. Once the timer ends, the fan will trigger to run at the speed set in ON mode. If there is a speed set in OFF mode greater than 0, the fan will run at that speed during the countdown.

The countdown will begin if no buttons are pressed for 5 seconds. The time left on the countdown is shown on the bottom left corner of the display. Leaving the timer mode while the countdown is running will pause it until you return to this mode.



If there is a speed set in OFF Mode other than zero, the fans will run at that speed when triggered to turn off.

TIMER TO OFF MODE

Pressing the up or down button sets a countdown time. The fan will run at the speed set in ON mode until the countdown ends. If there is a speed set in OFF mode greater than 0, the fan will run at that speed at the end of the countdown.

The countdown will begin if no buttons are pressed for 5 seconds. The time left on the countdown is shown on the bottom left corner of the display. Leaving the timer mode while the countdown is running will pause it until you return to this mode.



If there is a speed set in OFF Mode other than zero, the fans will run at that speed when triggered to turn off.

PROGRAMMING

CYCLE MODE (ON & OFF)

Set an on duration and an off duration for the fan to cycle through continuously. Press the up or down button to first set a duration for the fan to activate. Then press the mode button again and set a duration for the fan to deactivate.

When the fan is activated, it will run at the speed set in ON Mode. When the fan is deactivated, it will run at the speed set in OFF Mode.

The countdown will begin if no buttons are pressed for 5 seconds. The time left on the countdown is shown on the bottom left corner of the display. Leaving the cycle mode while the countdown is running will pause it until you return to this mode.

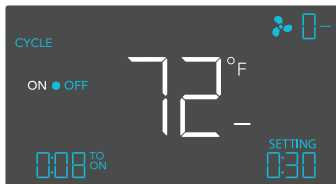
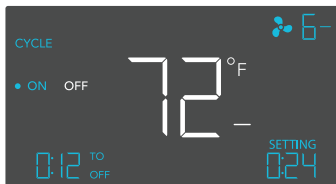

If there is a speed set in OFF Mode other than zero, the fans will run at that speed when triggered to turn off.

PROGRAMMING

CONTROLLER SETTINGS

Press the setting button will cycle through the controller's available settings: DISPLAY, F/C, CALIB. T°, and TRANS. T°.

DISPLAY SETTING

Adjusts the display brightness and auto-dimming. Press the up or down button to cycle through levels 1, 2, 3, A2 and A3; 3 being the highest brightness setting, while 1 is the lowest. In settings 1, 2 and 3, the display will stay at that brightness level and will not automatically dim the display.

A2 and A3 will set the brightness level at 2 and 3, respectively, and will dim down the brightness level 1 when the controller is not being used after 30 seconds.

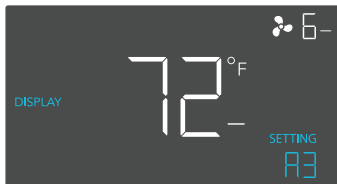

TOGGLING THE DISPLAY

Lock the controller by holding the setting button.

Press the setting button to turn the display off. Pressing the setting button again will turn the display back on.

Programs will still run in the background while the LCD screen is off.

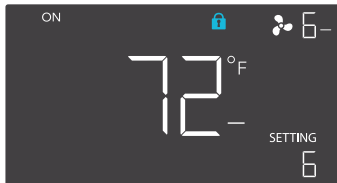

PROGRAMMING

°F/°C SETTING

Changes the displayed units to Fahrenheit or Celsius. Press the up or down button to cycle through F and C. All displayed units will automatically convert when adjusting this setting.



CALIBRATION TEMPERATURE SETTING

Adjusts the temperature reading the sensor probe is measuring. Press the up or down button to increase or decrease the data figure in 2°F (or 1°C) increments. The calibration cycle ranges from -20°F to 20°F (or -10°C to 10°C) and will be applied to the sensor probe's measurements.



PROGRAMMING

TRANSITION TEMPERATURE SETTING

Adjusts the transition threshold between the fan speeds in the AUTO Mode temperature triggers.

Press the up or down button to cycle through 0°F to 8°F (0°C to 4°C) and set a transition threshold. The fan speed will be set one level above the OFF Mode speed when the sensor temperature first meets or exceeds the high temperature trigger. For every transition threshold crossed, the fan speed will ramp up by one speed level, up until it reaches the speed set in ON Mode.

In this example, your high temperature trigger is set at 80°F, the OFF Mode speed is 0, and the ON Mode speed is 6. If the transition threshold is set to 0°F, then the fan will trigger to run at speed 6 when the sensor temperature meets or exceeds 80°F. However, if the transition threshold is set to 2°F, then the fan will trigger to run at speed 1 when it meets or exceeds 80°F. It will then step up to speed 2 when meeting or exceeding 82°F, speed 3 at 84°F, speed 4 at 86°F, and speed 5 at 88°F. From 90°F on, it will run at speed 6, the speed set in ON Mode.

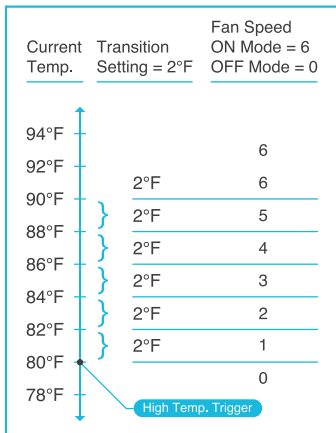
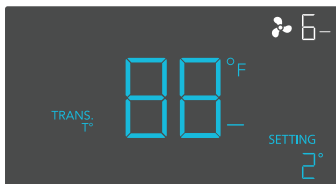

PROGRAMMING

ALERT ICONS

The alert icons are displayed at the top of the screen. Icons may flash when the controller signals an alert to tell you a particular function or alarm is being triggered.

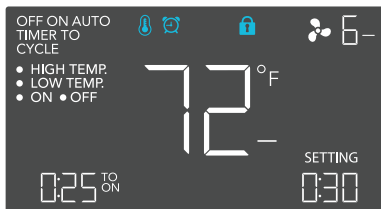

CONTROLLER LOCK ALERT

This icon is visible when the controller has been locked. The icon will flash to alert you that the controller is locked if you try to change the mode or settings.



TRIGGER ALERT

This icon will appear and beep once when an AUTO Mode has been triggered.



TIMER ALERT

This icon will appear and beep once when a TIMER Mode has been triggered.

OTHER SETTINGS

CONTROLLER LOCK

Holding the setting button will lock the controller in the respective mode you are in. While your controller is locked, no parameters may be adjusted nor will you be able to switch modes. Holding the setting button again will unlock the controller.



HIDE SCREEN

Lock the controller so no settings can be adjusted. Refer to the setting above. Then press the setting button to turn the display off. Pressing the setting button again will turn the display back on. Programs will still run in the background while the LCD screen is off.



SET MODE PARAMETER TO OFF

Holding the up and down buttons together for 2 seconds will reset the parameter of the mode you are in to OFF or 0. Pressing either the up or down button will return the parameter to the mode's last setting.



FACTORY RESET

Holding the mode, up, and down buttons together for 5 seconds will reset your controller and restore factory settings. This will clear all user set parameters in each controller mode and setting.



AUTO INCREASING OR DECREASING

Holding the up or down button will increase or decrease user setting automatically until the user releases the up or down button.



CLOUDLINE FAQ

Q: I am missing my controller. It wasn't included in my package!

A: Please refer to page 7 for an image of what your controller should look like. Your controller should be neatly slotted in the box by this product manual.

Q: Where is the best place to position the sensor probe?

A: Place the sensor probe as close as possible to the hottest or most humid spot in your space.

Q: Do I need to remove the plastic cap from the probe?

A: Yes. You will need to remove the plastic cap so the probe can accurately read climate conditions.

Q: Can I mount this inline duct fan vertically?

A: Yes. The CLOUDLINE can be mounted in any orientation, including vertically.

Q: Will I be able to hardwire this fan to my own controller or thermostat?

A: We do not recommend hardwiring or splicing our fan's power wires. Such modifications may compromise electrical safety and will void this product's warranty.

Q: Do I need to use a power converter if I'm outside the US?

A: This product's voltage range is 100-240V AC. You may need a simple travel adapter to plug it into a foreign socket, or a power converter if your country uses a different voltage.

CLOUDLINE FAQ

Q: Does the controller retain its settings after power is shut off?

A: Yes. If the controller's power is cut off and is powered on afterwards, your settings will remain.

Q: What is the CFM of each of the different fan speeds?

A: Please refer to your CLOUDLINE model's product listing for its CFM specification.

Q: I'm not getting enough airflow even after setting the fan speed to 10. What can I do?

A: Bends in ducting will reduce your fan's CFM performance. To retain airflow, you may straighten the ducting and eliminate as many bends as possible.

Q: Should I use this inline duct fan as an intake or an exhaust fan?

A: The CLOUDLINE is primarily used as an exhaust fan, but can be used as an intake fan as well. You may use this fan as an intake fan if you need fresh air into your space.

Q: Can I connect different sized fans to the same controller?

A: Please refer to page 25 for details on daisy chaining fans together.

Q: I'm hanging my fan upside down in my grow tent, can I rotate its motor box plate?

A: Yes. Use a screw driver to unscrew the motor cap. Rotate it to your desired orientation and reapply the screws.

AC INFINITY PRODUCTS

Advance Grow Tents

The CLOUDLAB series is a line of grow tents designed to create ideal growing conditions and facilitate indoor plant cultivation year-round. Features 2000D thick oxford canvas lined with inner diamond patterned mylar that maximizes grow light luminosity, and a reinforced frame with 150 lb. weight capacity. Includes a mounting plate to install your AC Infinity controller onto.

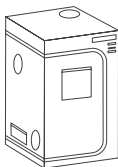

Carbon Filter

The duct carbon filter is designed to eliminate odors and chemicals for grow tents and hydroponic spaces. It utilizes premium grade Australian charcoal that features greater absorption power and a longer lifespan. Enables maximum airflow pass through as part of an intake or an exhaust system.

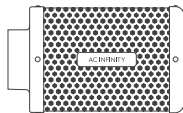

Ducting Tubes

The four-layer ducting tube is used to direct airflow, designed for ventilation systems in applications like HVAC, dryers, and grow rooms. It is highly durable and flexible, and can be used anywhere from tight spaces to wide open areas.

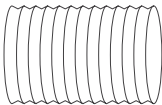

WARRANTY

This warranty program is our commitment to you, the product sold by AC Infinity will be free from defects in manufacturing for a period of two years from the date of purchase. If a product is found to have a defect in material or workmanship, we will take the appropriate actions defined in this warranty to resolve any issues.

The warranty program applies to any order, purchase, receipt, or use of any products sold by AC Infinity or our authorized dealerships. The program covers products that have become defective, malfunctioned, or expressively if the product becomes unusable. The warranty program goes into effect on the date of purchase. The program will expire two years from the date of purchase. If your product becomes defective during that period, AC Infinity will replace your product with a new one or issue you a full refund.

The warranty program does not cover abuse or misuse. This includes physical damage, submersion of the product in water, incorrect installation such as wrong voltage input, and misuse for any reason other than intended purposes. AC Infinity is not responsible for consequential loss or incidental damages of any nature caused by the product. We will not warrant damage from normal wear such as scratches and dings.

To initiate a product warranty claim, please contact our customer service team at support@acinfinity.com



If you have any issues with this product, contact us and we'll happily resolve your problem or issue a full refund!

COPYRIGHT © 2021 AC INFINITY INC. ALL RIGHTS RESERVED

No part of the materials including graphics or logos available in this booklet may be copied, photocopied, reproduced, translated or reduced to any electronic medium or machine readable form, in whole or in part, without specific permission from AC Infinity Inc.

www.acinfinity.com