

Cooking & Canning With The
ALL AMERICAN[®]
PRESSURE COOKER/CANNER

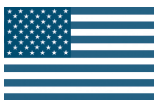

The professional quality deluxe cast aluminum Pressure Cooker/Canners with the exclusive “Metal-To-Metal” seal.

INSTRUCTIONS & RECIPES



DESIGNED AND MANUFACTURED IN THE USA



CAUTION! READ THESE IMPORTANT SAFEGUARDS!

When using pressure cookers, basic safety precautions should always be followed to reduce the risk of personal injury or property damage:

1. Read all the instructions.
2. Close supervision is necessary when the pressure cooker/canner is used near children.
3. Always make sure that the pressure regulator weight vent pipe opening is clean and you can see through it.
4. Do not put the pressure cooker into a heated oven.
5. Move the pressure cooker under pressure with extreme care. Do not touch hot surfaces. Use handles and pot holders.
6. Do not use the pressure cooker/canner for other than intended use.
7. This appliance cooks under pressure. Scalding may result from inappropriate use of the pressure cooker. Make sure that the cooker is properly closed before applying heat.
8. Never force open the pressure cooker. Do not open before making sure that its internal pressure has completely dropped.
9. Never use your pressure cooker without adding water. This would seriously damage it.
10. Do not fill the cooker beyond $\frac{2}{3}$ of its capacity. However, when cooking foods which expand during cooking, such as rice or dehydrated vegetables, do not fill the cooker to more than $\frac{1}{2}$ of its capacity.
11. Do not cook foods such as applesauce, cranberries, pearl barley, oatmeal or other cereals, rice, split peas, noodles, macaroni, rhubarb, spaghetti or soup mixes containing dry beans or peas. These foods tend to foam, froth, and sputter, and may block the pressure release device (steam vent). (For cooking dry beans and peas, reference page 49)
12. Use the appropriate heat source(s) according to the instructions for use.
13. After cooking meat with a skin (e.g. chicken) which may swell under the effect of pressure, do not prick the meat while the skin is swollen; you might be scalded.
14. Never use the pressure cooker in its pressurized mode for deep or shallow frying of food (broasting).
15. Do not tamper with any of the safety systems beyond the maintenance instructions specified in the instructions for use.
16. Only use manufacturer's spare parts in accordance with the relevant model.
17. Never loosen wing nuts until the steam pressure gauge reads zero and you have allowed any remaining pressure to escape by removing the pressure regulator weight.
18. Do not subject your cooker/canner to sudden extreme temperature changes as this will cause expansion or contraction which can crack a cast aluminum utensil. Do not move a cooker from a cold storage area directly onto a hot flame or element. Do not add cold water to cooker/canner which has boiled dry and is still hot. Do not cool a hot cooker/canner suddenly by pouring cold water on it or wrapping cold wet towels around it.
19. When normal operating pressure is reached, turn the heat down so all the liquid, which creates steam, does not vent out.
20. Be sure that wing nuts are assembled and fastened properly before each use. Cracked, broken or charred wing nuts should and must be replaced. The No. 64 phenolic wing nut should be threaded into the No. 54 clamp bolt four (4) complete revolutions before bringing assembly into the hold down position. When all the wing nuts are in hold down position, tighten all evenly.
21. ALL AMERICAN pressure cooker/canners are NOT recommended for use on glass top ranges without first checking with your manufacturer. Our models 930 and 941 are too heavy and could cause damage to your range/DO NOT slide the pressure canner over a glass range surface as it could scratch and damage it.

SAVE THESE INSTRUCTIONS.

Cooking And Canning With Heavy Cast Aluminum

ALL AMERICAN Pressure Cooker/Canner

TABLE OF CONTENTS

Important Safeguards.....	1
Warranty.....	Tear-off Reply Cards
Table of Contents.....	2
Model Information.....	3
Warning Labels.....	4
About the ALL AMERICAN Pressure Cooker.....	5
Important Safety Precautions.....	9
Getting Acquainted with the Parts.....	6 & 7
Parts Diagram.....	8
Before Using Your Cooker/Canner for the First Time.....	9
Putting the Cover On.....	9
Caring for Your Cooker.....	10-12
Storing Your Pressure Cooker.....	12
Canning Terms.....	13
Safety Tips for Home Canning.....	14
Causes of Spoilage.....	14
Canning Terms.....	15
Packing Cans or Jars.....	16 & 17
Storing Cans and Jars.....	16
Labeling Cans and Jars.....	16
Directions for Using Glass Jars.....	17 & 18
Directions for Using Tin Cans.....	18
Reducing Pressure.....	21
Removing a "Stuck" Cover (due to vacuum).....	21
Canning Instructions.....	20
Preparing Fruit for Canning.....	22-25
Preparing Tomatoes and Tomato Products for Canning.....	26-28
Spaghetti Sauces.....	29 & 30
Preparing Poultry, Red Meats and Seafoods for Canning.....	31 - 35
Preparing Vegetables for Canning.....	36-42
Questions and Answers on Home Canning.....	43 & 44
Basic Cooking Instructions.....	45 & 46
Cooking in the Pressure Cooker.....	47 & 48
Pressure Cooking Dry Beans.....	49
Tables and Charts.....	50
Repair Parts List.....	51
Parts Illustrations.....	52
Index.....	53
ALL AMERICAN Automatic Master Sealer.....	54

CAUTION!

READ THIS BOOKLET BEFORE USING. IMPROPER USE MAY RESULT IN SCALDING INJURY. DO NOT OPEN COOKER/CANNER UNTIL ALL PRESSURE IS RELEASED AND GAUGE IS AT ZERO. DO NOT OVERFILL UNIT. BE SURE TO READ AND UNDERSTAND ALL OPERATING INSTRUCTIONS BEFORE USING COOKER. READ THE IMPORTANT SAFEGUARDS ON PAGE ONE (1).

ALL AMERICAN HEAVY CAST ALUMINUM PRESSURE COOKER/CANNER LIMITED WARRANTY

This quality pressure cooker/canner is designed and manufactured to provide many years of satisfactory performance under normal use. Wisconsin Aluminum Foundry pledges to the original owner that should there be any defects in material or workmanship during the first year after purchase, we will repair or replace it at our option. This pledge does not apply to damage caused by shipping. To obtain service under the warranty:

1. Call the Customer Service Department to obtain a Return Authorization Number. Items returned without a Return Authorization Number will be refused.
2. Return pressure cooker/canner, postage prepaid, with sales receipt, Return Authorization Number and a description of the claimed defect to:
 Wisconsin Aluminum Foundry Co., Inc.
 Consumer Products Division
 1931 South 14th Street
 Manitowoc, WI 54220

IMPORTANT — PLEASE READ

Any alterations, modifications or changes of any type made to the pressure cooker/canner or to any component thereof will void this warranty.

We want you to obtain maximum performance from using this quality pressure cooker/canner, and we ask that you take the time to read and follow the operating instructions. Failure to follow instructions, damage caused by improper replacement parts, abuse, or misuse will void this pledge. This warranty gives you specific legal rights, and you may also have other rights which vary from state to state.

DIMENSIONS, WEIGHTS AND CAPACITIES OF ALL AMERICAN PRESSURE COOKERS

MODEL	910	915	921	925	930	941
LIQUID CAPACITY (Qts.)	10½	15½	21½	25	30	41½
Inside Diameter, Inches	10¾	12¾	12¾	12¾	12¾	15¼
Inside Height, Inches	7¾	7½	10½	11½	14	13¾
Shipping Weight, lbs.	16	21	24	25	30	39
*Will Hold Approximately:						
Pint Jars	7	10	19	19	19	32
Quart Jars	4	7	7	7	14	19
No. 1 Cans	14	22	35	36	44	73
No. 2 Cans	7	12	18	20	25	36
No. 3 Cans	3	5	10	10	10	21
No. 10 Cans	1	1	1	2	2	6

***Please note:** Jar counts are based on the Standard Mason Jar. Capacities are approximate and may vary with the brand of jar.

Record your model number here:

SAFETY WARNING LABELS

The heat resistant warning label pictured below is located on the top of your pressure cooker/canner. Please refer to the drawing below for location placement of safety warning label. Please **DO NOT REMOVE** this warning label. In the event that your pressure cooker/canner ever requires replacement labels, please contact the manufacturer and a new replacement label will be promptly sent out to you free of charge.

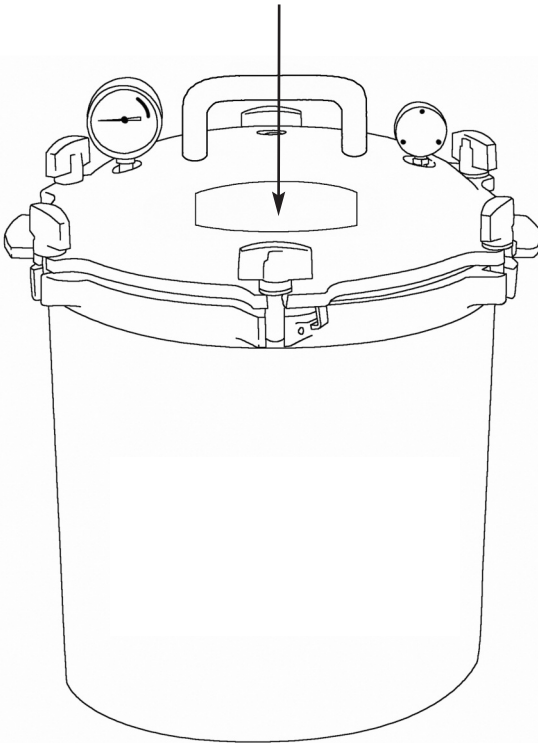

ABOUT THE ALL AMERICAN PRESSURE COOKER/CANNER

The ALL AMERICAN PRESSURE COOKER/CANNER offers the busy cook many money-saving advantages:

Safe canning. Pressure cooking provides the only safe method for canning non-acid foods such as vegetables, fish, meat and poultry. It is perfect for canning in tin cans as well as in glass jars.

Saves time and energy. The pressure cooker prepares foods in a fraction of the time required by other cooking methods.

Healthier. Foods cook quickly in a minimum amount of liquid, helping foods retain flavor and healthy nutrients.

Saves money. Budget cuts of meat are quickly cooked to juicy tenderness in the pressure cooker. The high temperature and pressure makes meat tender and flavorful without the use of chemical tenderizers.

Saves clean-up. Since food flavors do not mingle in live steam, several foods may be prepared in the cooker at the same time without mixing flavors.

OTHER CANNING/COOKING RESOURCES & INFORMATION

- County University/Extension Office
- Extension Agent / Home Economist (Check local phone book for number or call information)
- Library - Books under Canning, Food Preservation, Home Canning
- Bookstores – Books under Canning, Food Preservation, Home Canning

INTERNET SEARCH

FOR ADDITIONAL INFORMATION ON HOME CANNING, PLEASE VISIT THE FOLLOWING WEBSITES:

- UW Georgia: www.uga.edu/nchfp (National Center for Home Food Preservation)
- UW Pennsylvania: www.foodsafety.psu.edu/preserve.html
- UW Wisconsin: www.foodsafety.wisc.edu/preservation.html
- www.homecanning.com

DVD's FEATURING OUR ALL AMERICAN PRESSURE COOKER/CANNER

PART NO. 313 DVD – 1 HOUR 49 MINUTES, “AT HOME CANNING”

At Home Canning shows you safe and easy methods of canning at home. This DVD demonstrates everything you need to know to start water bath canning and pressure canning in your very own kitchen. It shows you how to cook up a variety of foods and meals for you and your family to enjoy.

PART NO. 814 DVD – 10½ MINUTES, “BASIC OPERATING INSTRUCTIONS”

This DVD does what the title says...it gives you the basic information about the various parts of the pressure cooker/canner in a clear, concise language enabling you to quickly learn what the various parts are and how they are used. This DVD is included with all models of the ALL AMERICAN cooker/canner. It can also be viewed online at www.aa-cd.co under the video tab.

GETTING ACQUAINTED

1. **Pressure Dial Gauge:** Easy to read pressure gauge lets you know when the internal pressure is down to zero and the cooker/canner is safe to open.



Part #72

2. **Side Handles:** Use the side handles when lifting the pressure cooker. Models 930 & 941 have larger handles attached to body.



Part #405
(Model 930& 941)

3. **Top Handle:** The top handle is used to place or remove the cover on to, or off of the bottom only. Never lift the entire cooker by using the top handle.



Part #76-09 w/screws

4. **Wing Nuts:** The cover is secured with large, stay-cool phenolic wing nuts. These will require lubrication from time to time. (Please see page 8)



Part #64

5. **Clamp Bolts:** Threaded aluminum bolts that attach to the wing nuts, and help to hold the cover down tight.



Part #54

6. **Automatic Pressure Control:** This is made up of the round selective pressure regulator weight and the vent pipe. The vent pipe is attached to the cover and the pressure regulator weight sits on top of the vent pipe.



Part #68

-
-
7. **Vent Pipe:** The vent pipe is the primary pressure relief valve and is attached to the cover, the pressure regulator weight fits on top of it.



Part #69

8. **Overpressure Plug:** This safety device will automatically vent steam if the vent pipe becomes clogged. Please see page 12.



Part #2040

9. **Canning/Cooking Rack:** Used to keep the jars away from direct heat, and to keep jar layers separate in the bigger models.



Part #111 & 151

10. **Retaining Bayonet Clamps:** Three safety lugs catch the bottom and secure it into place as an added safety feature. (not shown on diagram)



Part #78

11. **Metal-to-metal Seal:** This means you never need to replace a broken, cracked or hardened gasket. The exclusive metal-to-metal seal improves with use if properly cared for and lubricated. (Please see page 10)

12. **Cover:** Extra heavy, high-grade cast aluminum. Holds the gauge, pressure regulator weight, and overpressure plug. (Shown on page 8)

13. **Bottom:** Extra heavy, high-grade cast aluminum heats quickly, wears well, cleans easily, and will not rust. The collar has double thickness edges for extra safety and durability. (Shown on page 8)

PARTS DIAGRAM

SIDE HANDLE SAFETY IMPORTANT NOTICE!

Only use the side handles to lift the pressure cooker. This applies to the pressure cooker when it is empty or contains items. **NEVER** use the top handle to lift the complete unit. The top handle is used to remove the cover only.

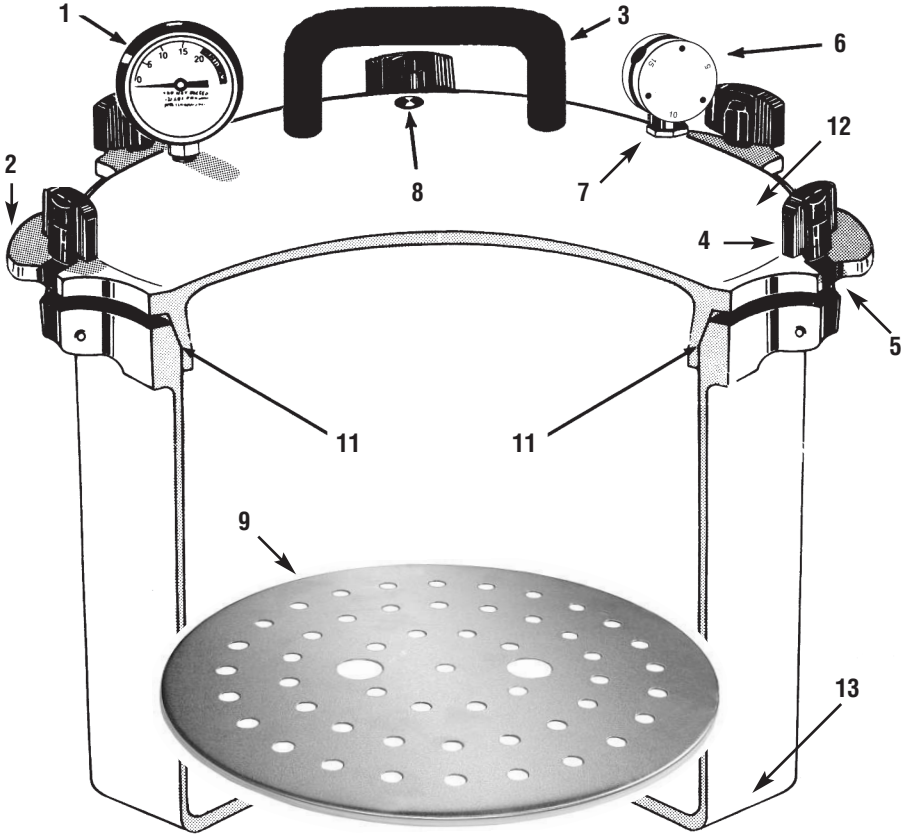

REPLACEMENT PARTS – WHERE TO ORDER

ALL AMERICAN cooker/canner parts are available from online retailers or they can be ordered directly from Wisconsin Aluminum Foundry Co.

Call our Customer Service at 920-682-8627, E-mail customerrelations@wafco.com, or go to www.aa-cd.co to find an online retailer.

BEFORE USING THE COOKER/CANNER FOR THE FIRST TIME

1. Read all important safeguards located on the inside of the front cover.
2. Hand wash the cover and bottom with hot, soapy water to remove any manufacturing oils. **Do not submerge the dial gauge in water.** Rinse all parts with warm water and dry. **Note: Do not put pressure cooker canner in dishwasher.**
3. Apply a thin film of olive oil (preferred) or petroleum jelly onto the beveled edge of the bottom where the cover touches. (See Diagram A) Use just enough to wet the edge. (also see page 10, Metal-to-Metal Seal)
4. To help understand the operation of the pressure cooker/canner, do a trial run by pouring 2-3" of water into the cooker/canner after you have lubricated the sealing surface, and follow the step-by-step instructions on page 20, starting with step 5. This will help familiarize you with the metal-to-metal seal, tightening the cover down using the wing nuts, and the proper jiggling of the pressure regulator weight. For actual usage of the canner, follow the complete instructions beginning on page 20 for pressure canning and on page 45 for pressure cooking.
5. Go to www.aa-cd.co and click "VIDEO" for a demonstration video of how to use your cooker/canner. Also, see page 5 for DVD's.

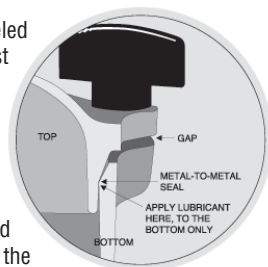

Diagram A

PUTTING THE COVER ON

The cover of your pressure cooker/canner is designed to seal tightly without the use of a rubber gasket. The metal surfaces where the cover and cooker meet are beveled to produce the exclusive metal-to-metal seal. *As a result, the cover will wobble slightly when placed on the bottom before the wing nuts are fully fastened.* When the cover is properly seated, there is a small even gap all the way around between the cover and the bottom. To secure the cover, read the following:

1. Using the cover handle, set cover on top of cooker/canner bottom so the arrow on the cover is a little to the right of the notch mark on the bottom. (See Diagram B)
2. Using the handle, turn the cover clockwise to line up the arrow on the cover with the notch mark on the cooker/canner bottom. This will engage the bayonet clamps under the lugs. (See Diagram C)
3. Grasp two opposite wing nuts, one in each hand, and flip them up above the cover into the notches. (You may need to loosen the wing nuts by turning them counter clockwise in order to get them to fit over the cover.)
4. Gradually and evenly tighten those two opposite wing nuts down by turning them clockwise. At that point, make sure the gap between the cover and bottom is even under those two wing nuts by getting an eye level view of the gap. **Never tighten just one wing nut at a time.**

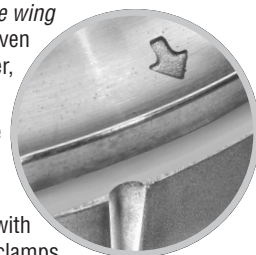

Diagram B

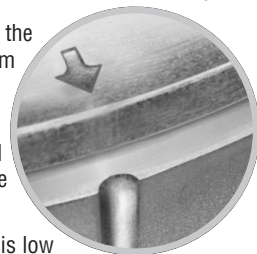

Diagram C

If the gap is not even under the two opposite wing nuts, loosen the side that is low and tighten the side that is high until the gap is even.

5. Repeat steps 3-5 until all the wing nuts are secured.
6. Turn each wing nut one more time to assure they are snug. **Hand-tighten only. Do not use a wrench or any other tool.**
7. Double check the gap between the cover and bottom to make sure it is even all the way around. If it is not, you will need to undo the wing nuts and repeat the above steps.

CARING FOR YOUR COOKER/CANNER

READ BEFORE USING PRESSURE COOKER/CANNER

For your own safety and to avoid damaging the cooker/canner, please read these instructions carefully before using.

Metal-to-Metal Seal

Before using your cooker/canner, you must lubricate the metal-to-metal seal area with olive oil. If olive oil is not available, you may use Vaseline. We do not recommend using cooking oil because there are so many different grades that some simply gum-up and do not work very well. Apply a thin film of lubricant to the edge inside the cooker where the inside wall begins to bevel out see Diagram D below. Use just enough lubricant to wet the edge, but not enough to actually see it.

It is also important to periodically wipe off the metal-to-metal seal with a clean towel to remove any build-up of foreign material trapped in the lubricant. You may use a red 3M brand Scotch Brite pad, the **red** color only. You can also use an SOS scrubbing pad. With pad, clean bottom seal using a horizontal motion around the circumference to remove any build-up of hardened lubricant. **Do not** use a vertical or small circular motion and avoid hard scrubbing of the metal-to-metal seal to prevent damage. After this is complete, wash the seal with hot soapy water, rinse, dry, and lubricate the metal-to-metal seal.

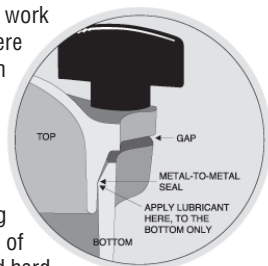

Diagram D

Wing Nut/Clamp Bolt

From time to time, place a small amount of lubricant on the threads of the phenolic wing nut. You can unscrew the wing nut and put the lubricant inside the threaded opening or on the clamp bolt and screw the wing nut back on. Vaseline or olive oil works well in this instance. Also lubricate the metal surface at the base of the wing nut where the bottom of the wing nut comes in contact with the aluminum surface of the pressure cooker lid (see Diagram E below). Wipe away excess lubricant. This will help the wing nuts turn more easily and hold the cover securely to the cooker/canner, preventing steam leaks.

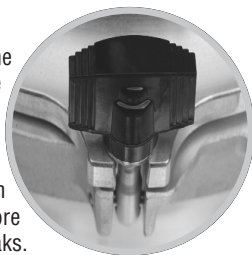

Diagram E

Keep Safety Openings Clear

It is important to inspect the openings of the vent pipe, and the pressure dial gauge regularly to make sure steam can pass through them.

Before each use, hold the cover up to the light and look through the vent pipe (see Diagram F). If the vent pipe is blocked, excess pressure cannot be released through it. Pressure may then build to unsafe levels. Pressure will continue to build until the overpressure plug is forced out of its cover opening. Therefore, if it is blocked or partially blocked, clean the vent pipe by inserting the #75 cleaning rod, a piece of wire, or a pipe cleaner in the vent pipe and run it gently in and out to be sure the opening is clear and unobstructed. Rinse with hot water.



Diagram F



#75 cleaning rod

Testing Steam Pressure Gauge

ALL AMERICAN pressure cooker canners are weighted-gauge canners. The pressure dial gauge is supplied as a *reference only* for when the unit is pressurized and timing for canning may roughly begin, or when the pressure has dropped to zero and the lid may be safely removed. The accuracy of your pressure dial gauge is +/- 2 pounds.

To test if the pressure dial gauge is functioning properly, compare the dial gauge to the regulator weight when heating the unit. If the gauge is within +/- 2 psi of what you have the regulator weight set at when it jiggles, the gauge is fine and doesn't need to be replaced. If the gauge is more than +/- 2 psi of what the regulator weight is set at when it jiggles, the gauge should be replaced.

Use Adequate Liquid/Water

It is critical to understand the importance of having enough water in the cooker when in use. During cooking or canning, you should use 2 to 3 inches of hot water in the bottom of the canner before you place the filled jars on the rack. Water level must be maintained during the canning process. Check the water level between batches. Please read the recipes or canning instructions. You must never allow the pressure cooker to boil dry. If there is not enough water in the pressure cooker and it boils dry, the unit will be ruined, cannot be repaired, and must be replaced.

Filling Cooker

The pressure cooker/canner should never be more than $\frac{2}{3}$ full when cooking foods like soups or stews. When cooking foods which expand, please refer to number 11 on page 1 for foods you should never cook. Otherwise, fill the cooker only $\frac{1}{2}$ full. Half full means the pot is $\frac{1}{2}$ full of the food and water combined, resulting in never occupying more than half of the total volume of the cooker.

Excess Pressure

The pressure regulator weight is designed to release excess steam at 18 pounds of pressure. However, if the vent pipe becomes clogged inside with food or grease buildup, it will not function. If the steam pressure gauge registers in the black CAUTION range and the pressure regulator weight has not automatically released pressure, do the following at once:

- 1) Turn off the heat source. Do not move the pressure cooker.
- 2) Allow the cooker to stand until cold to the touch (this may take an hour or more). Only then is it safe to remove the cover, and only remove cover after the gauge reads at ZERO.
- 3) Clean the vent pipe and the pressure dial gauge passage as described on page 10. You may purchase a new vent pipe from the factory if needed.

Temperature Fluctuation

Do not subject your cooker to sudden extreme temperature changes as this will cause expansion or contraction which can crack cast aluminum. Do not move a pressure cooker from a cold storage area directly onto a hot flame. Do not add cold water to a pressure cooker which has boiled dry and is still hot. Do not cool a hot pressure cooker suddenly by pouring cold water on it or wrapping cold wet cloths around it.

Opening Safely

Be sure the pressure gauge has dropped to zero and that you have removed the pressure regulator weight before loosening the wing nuts. **When removing cover, raise the farthest edge first to protect face and arms from steam.**

Dropping the Pressure Cooker

If you ever drop your pressure cooker, it must be examined for damage. If it is dropped on a hard surface, call for a Return Authorization number and return the unit to Wisconsin Aluminum Foundry with a note explaining that the unit was dropped and that you would like it examined. We will check it thoroughly, including the pressure regulator weight and steam pressure gauge, and notify you of our findings and the repair charges.

Discoloration and Pitting

Discoloration of aluminum inside from hard water minerals is harmless. It can be removed by boiling a solution of one tablespoon vinegar or two level tablespoons cream of tartar in a quart of water, or by scrubbing with aluminum cleaner or soap impregnated steel wool cleaning pad.

Pitting is caused by the interaction of aluminum with other metals in the presence of moisture. This can be prevented by washing, rinsing and drying the unit thoroughly after every use. **Remember: do not put in dishwasher.** Always store the pressure cooker in a dry area when not in use. While pitting is not injurious to health, if pitting becomes present and you detect it in the metal, then we recommend that the unit be returned to the factory for examination. Do not use the unit if pitting is present until it is determined the extent of damage caused by pitting.

Storage

The cover should be stored separately from the bottom or upside down on the bottom to allow air circulation. Always be sure the cover and bottom are thoroughly dried to protect against pitting and corrosion. Protect the metal-to-metal seal from being struck or dented.

Overpressure Plug

The overpressure plug releases if the vent pipe becomes blocked and the cooker/canner develops too much pressure. This is a protection that permits excess pressure to be released safely. If you follow directions for using the unit properly, the plug will probably never release.

A small amount of steam or moisture may be visible around the overpressure plug as the pressure is starting to build inside the unit. It is normal for the overpressure plug to leak steam until approximately 5 pounds is shown on the pressure gauge. If leakage continues beyond that point, the cause may be:

- 1) The overpressure plug needs replacing if it is worn, cracked or hard. We recommend that you replace the overpressure plug every 12 months, or before if it becomes hard or deformed. Never reuse a blown overpressure plug.
- 2) Built-up food or grease may be in the opening. We recommend that the opening in the cover where the overpressure plug fits be cleaned with hot soapy water and a small brush at least once every month during periods of use to maintain a clean opening. This cleaning/inspection is in addition to normal cleaning performed after using the unit.

TO REMOVE THE OVERPRESSURE PLUG: From the underside of the cover, pull the plug out of its opening using your fingers. After cleaning, reinsert the overpressure plug by pushing the round top side of the overpressure plug into the opening from the underside of the cover. When the overpressure plug is correctly in position, the indented portion will be visible when the underside is viewed. Check that the round top of plug and top lip are fully through the opening so that the top lip is not folded under. (There is a video that shows how to do this at www.aa-cd.co)

CANNING TERMS

Acid Foods

Fruits, acidified tomatoes, pickles, relishes, chutneys, jams, jellies and preserves are acid foods – those foods with enough natural acid or enough additional acid (lemon juice or vinegar) to result in a pH of 4.6 or lower. Acid foods may be safely canned using a hot water bath method.

Botulism

A deadly form of food poisoning caused by toxins produced by the growth of botulinus spores. For more on botulism and how to prevent it, see page 15.

Buckling

This term applies to cans in which one or both ends have been permanently distorted by excess pressure in the can. Slack filling (more liquid than solid food), sealing at too low a temperature, or too sudden of a release of pressure after cooking can all cause buckling.

Raw-Pack Method

Filling hot jars with raw, unheated food prior to processing.

Hot-Pack Method

Filling hot jars with hot precooked food before processing.

Hot Water Bath

The canning method used to process acid foods.

Headspace

The distance between the food in the jar/can and the cover of the jar/can. Leave at least ½-inch headspace to most canned foods. Failure to leave headspace may cause bulging of the cans due to over filling.

Low-Acid Foods

Foods with little natural acid which have a pH above 4.6. This includes meats, poultry, seafood, milk, vegetables and some varieties of tomatoes. Low-acid foods must be processed in a pressure canner.

Swell

Swell is the commercial term given to cans whose ends have been distended or swelled by the gas which has been generated by spoilage of the food in the can. Any can with ends swelled out should be thrown away as it is not fit for use, unless the can was filled too full or was not sealed while hot. See “Headspace.”

Vacuum

Vacuum as it applies to cans refers to a lower pressure within the container than on the outside. This higher pressure on the outside causes the ends of the cans to be held in a concave position. Vacuum is obtained by sealing the cans while they are hot. The condensation of the vapor in the headspace and the contraction of the gases and contents of the can upon cooling produce a partial vacuum in the can. Proper vacuum may be obtained by thorough pre-heating or exhausting just previous to closing. A can with a vacuum – that is, with the ends properly pulled in – is considered to contain good food. If the products start to spoil, gas is generated which releases the vacuum and causes the ends of the can to bulge.

SAFETY TIPS FOR HOME CANNING

Home food preservation must be done with care to protect the quality and safety of the food. Jars or cans containing low-acid foods such as vegetables, meats, poultry and seafood must always be processed under pressure to prevent spoilage or food poisoning. The bacteria which cause botulism, a severe and potentially fatal form of food poisoning, are not killed by using the hot water bath canning process. Low-acid foods must be processed under pressure at a temperature of 240°F (115.5°C) for the full recommended period of time.

To ensure the safety of the food you process at home, follow these precautions:

- Use only fresh food products.
- Keep all work surfaces, food and equipment clean.
- Make sure the pressure canner is in good working condition and that the pressure dial gauge is reading accurately.
- Pack and close food containers correctly.
- Process food at the recommended time and pressure.
- Test seals after cooling containers.
- Store canned foods in a cool, dry place.

SOME CAUSES OF SPOILAGE

Fermentation

Any bulged can or can with a loose seal should be considered suspicious. Bulging is due to carbon dioxide gas produced from fermentation, although other bad smelling gases may be mixed with it. Fermentation results from under cooking or from the introduction of air through a leak. The product will smell sour, appear soft and discolored, and have an offensive odor.

Flat Sour

There is nothing about the outside appearance of a can to suggest flat sour spoilage. Flat sour food is typically soft and mushy, although it may sometimes appear firm. Flat sour foods smell and taste sour, a result of organisms (thermopiles) which develop best at lukewarm temperatures. To avoid flat sour spoilage, follow thorough processing times and temperatures, and work quickly while canning to avoid holding foods at lukewarm temperature.

Corn, peas, green beans, greens and asparagus are prone to flat sour spoilage. To avoid flat sour, follow these tips:

- Can only fresh products. The flat-sour germs may develop before the product is canned and all the cooking in the world won't destroy the sour flavor after it has developed. Two hours from the garden to jar is a good rule of thumb.
- Don't let pre-heated or scalded products stand at lukewarm temperature. Get them into the can quickly and have them as hot as possible when they're put into the cans.
- Have the water boiling to avoid waiting too long for the temperature to come up after the cans are packed in the cooker.
- Don't try to can too much in one cooking.
- Keep burner at a relatively high temperature.
- Don't let jars or cans stand after being packed or before putting them into the cooker.
- Don't pack jars or cans too tightly; this ensures the heat will get to the center.
- Cool quickly. Don't stack jars or cans while cooling.
- Store in a cool place.

Botulism

This rarely occurs alone in canned food but is found in connection with other spoilage. A rank cheesy odor is typical of botulism in its well-developed stage. Discard without tasting all canned foods which show any signs of spoilage. This will minimize the risk of botulism poisoning, although the presence of this spoilage cannot always be determined by the appearance or odor of the food.

CHECK PRODUCT BEFORE EATING

All canned foods should be carefully inspected before use. As an added safety precaution, boil low-acid foods in an open pan before eating. (Boil meats, poultry, seafood, corn and spinach for 20 minutes; other vegetables, 10 minutes.) This will destroy the botulism toxin, should any be present.

To ensure the safety of home-canned fish, insert a meat thermometer in the can or jar with the tip at the center of the fish. Cover loosely with foil and heat in a 350°F (180°C) oven until the thermometer registers 185°F (85°C). Let container stand at room temperature for 30 minutes until temperature is uniform throughout.

Don't ever taste food you suspect to be spoiled. Never take a chance on slightly off food. Discard it.

DETECTING SPOILAGE

Immediately destroy any canned product you suspect has spoiled. Dispose of it where it won't be eaten by humans or animals. Discard the product if:

- The ends of the can are bulged or the seal on the jar is broken (test each can or jar by pressing the ends or lid; they should not bulge or snap back)
- The product contains gas bubbles or foam, or liquid squirts out when can or jar is opened
- Product looks soft, mushy, slimy, moldy or, in the case of meat, off-color
- Product smells spoiled when boiled (heat brings out the characteristic odor of spoiled food)

ACID OR LOW-ACID FOODS

Foods are considered either acid or low-acid, each of which requires a different canning method.

- **Acid foods**, which include most fruits, tomatoes acidified with bottled lemon juice or citric acid, pickles, relishes, chutneys, jams, jellies and preserves, may be safely processed using either a hot water bath or a pressure canner. (Figs are low-acid fruit, but if acidified before canning, they may be safely processed in a hot water bath.)
- **Low-acid foods**, such as meats, poultry, seafood, milk and vegetables *must be processed in a pressure canner*. Pressure canning is the only safe method for canning low-acid foods such as meats, poultry, seafood and vegetables according to the United States Department of Agriculture.

PACKING CANS OR JARS

Canning Jars

Mason-type jars specifically designed for home canning are best. Commercial mayonnaise jars may not seal and may break, and should never be used in a pressure canner.

Canning jars come in a variety of sizes from half-pint jars to half-gallon jars. Pints and quarts are the most commonly used sizes. Processing times have not been developed for many foods in half-pint, 12-ounce or one and one-half pint jars. If the recipe does not specify processing in one of these jars; process half-pint and 12-ounce jars for the same time as pints. Half-gallon canning jars are recommended only for very acid juices. The U.S. Department of Agriculture does not provide pressure canning timetables for half-gallon jars.

Two Packing Methods

The **hot-pack** method is preferred for most foods, especially acid foods that are processed in a hot water bath. Bring food to a boil and simmer for a few minutes. Pack food loosely into hot jars along with any hot liquid as the recipe requires. Hot-packing shrinks food, removes air from its tissue, helps keep it from floating in jars, and lengthens a product's shelf life.

The **raw-pack** method requires packing unheated prepared food tightly into hot jars, then covering the food with hot liquid. Raw-packing is more likely to result in floating food than hot-packing. Air may be trapped in both the food and the jars, causing food to discolor during storage.

Thermometer

Use a thermometer when canning meats or when instructions call for removing or exhausting air from cans or jars. With cans, the lid should not be placed on top until the contents are heated to at least 170°F (77°C). This is the minimum temperature needed to exhaust air properly so that a partial vacuum forms inside the can upon cooling.

Labeling Cans and Jars

Wipe off containers after they are cool. When labeling cans, use paste on selvage ends of the label, keeping it off of the tin, as this sometimes causes rust. Label with the date and contents of the container, particularly if some batches were packed differently – without salt, for example. If you canned more than one lot in one day, add a lot number.

Storing Cans and Jars

Screw bands are not needed on stored jars. They can be removed easily after jars are cooled. When removed, washed, dried, and stored in a dry area, screw bands may be used many times. If left on stored jars, they become difficult to remove, often rust, and may not work properly again. Store cans and jars in a cool, dry place. Exposure to heat, freezing temperatures or light decreases the quality and shelf life of canned food.

Freezing may damage the seal so that spoilage begins. In an unheated storage area, cover jars and cans with a clean blanket, or wrap them in newspapers.

For best eating quality and nutritive value, use canned goods within one year.

DIRECTIONS WHEN USING GLASS JARS

- 1) Inspect jars for chips in the rim and hairline cracks and discard damaged ones.
- 2) Inspect metal rings and discard any with dents or rust.
- 3) Wash jars, metal screw bands and lids in hot soapy water then rinse.
- 4) Place jars upside down on a clean, dry cloth or leave them in the dishwasher until needed.
- 5) Some metal lids with sealing compound may need to be boiled or held in boiling water for a few minutes before use. Follow manufacturer's directions.
- 6) Do not reuse flat metal lids.

Recommended Jars and Lids

Regular and wide-mouth Mason-type, threaded, home-canning jars with self-sealing lids are the best choice. With careful use and handling, Mason jars may be reused many times, requiring only new lids each time. When jars and lids are used properly, jar seals and vacuums are excellent and jar breakage is rare.

Jar Cleaning

Before every use, wash empty jars in hot water with detergent and rinse well by hand, or wash in a dishwasher. Un-rinsed detergents may cause unnatural flavors and colors. These washing methods do not sterilize jars. Scale or hard water films on jars are easily removed by soaking jars several hours in a solution containing 1 cup of vinegar (5 percent acidity) per gallon of water.

Sterilization of Empty Jars

All jams, jellies, and pickled products processed less than 10 minutes should be filled into sterile empty jars. To sterilize empty jars, put them right side up on the rack in a boiling-water canner. Fill the canner and jars with hot (not boiling) water to 1 inch above the tops of the jars. Boil 10 minutes at altitudes of less than 1,000 ft. At higher elevations, boil 1 additional minute for each additional 1,000 ft. elevation. Remove and drain hot sterilized jars one at a time. Save the hot water for processing filled jars. Fill jars with food, add lids, and tighten screw bands.

Empty jars used for vegetables, meats, and fruits to be processed in a pressure canner need not be pre-sterilized. It is also unnecessary to presterilize jars for fruits, tomatoes, and pickled or fermented foods that will be processed 10 minutes or longer in a boiling-water canner.

Lid Selection, Preparation and Use

The common self-sealing lid consists of a flat metal lid held in place by a metal screw band during processing. The flat lid is crimped around its bottom edge to form a trough, which is filled with a colored gasket compound. When jars are processed, the lid gasket softens and flows slightly to cover the jar-sealing surface, yet allows air to escape from the jar. The gasket then forms an airtight seal as the jar cools. Gaskets in unused lids work well for at least 5 years from date of manufacture. The gasket compound in older unused lids may fail to seal on jars.

Buy only the quantity of lids you will use in a year. To ensure a good seal, carefully follow the manufacturer's directions in preparing lids for use. Examine all metal lids carefully. Do not use lids that are old, dented, or deformed. Also, do not use lids that have gaps or other defects in the sealing gasket.

After filling jars with food, release air bubbles by inserting a flat plastic (not metal) spatula between the food and the jar. Slowly turn the jar and move the spatula up and down to allow air bubbles to escape. Adjust the headspace and then clean the jar rim (sealing surface) with a dampened paper towel. Place the lid, gasket down, onto the cleaned jar-sealing surface. Uncleaned jar-sealing surfaces may cause seal failures.

Fit the metal screw band over the flat lid. Follow the manufacturer's guidelines enclosed with or on the box for tightening the jar lids properly. Do not retighten lids after processing jars. As jars cool, the contents in the jar contract; pulling the self-sealing lid firmly against the jar to form a high vacuum.

If rings are too loose, liquid may escape from jars during processing, and seals may fail. If rings are too tight, air cannot vent during processing, and food will discolor during storage. Over tightening also may cause lids to buckle and jars to break, especially with raw-packed, pressure-processed food.

Checking the Seal

Jars with flat metal lids are sealed if the lid has popped down in the center, the lid does not move when pressed down, and tapping the center of the lid with a spoon gives a clear ringing sound. A dull sound, however, does not always indicate a poor seal.

Poor Seals

If a jar or can is not sealed, refrigerate contents and use or reprocess within 24 hours of the original processing. Process for the full time recommended. Quality of the food will not be as good after reprocessing.

Do not open and refill jars that have lost liquid during processing. Loss of liquid does not cause food to spoil; however, opening would contaminate the sterile contents.

DIRECTIONS WHEN USING TIN CANS

For general home canning, plain finish "R" enamel cans are used. "R" enamel cans have an inside coating of enamel intended primarily for the preservation of color in certain products. "C" enamel cans are used by commercial canners for certain products, and are not ordinarily available to the home canner. Follow instructions in each recipe as to the type of can to use, and unless otherwise stated in recipe, use plain cans.

Lids And Can Sealers

Lids are furnished with either a paper gasket or with a semi-vulcanized rubber gasket called Gold Seal. Both lids are satisfactory providing the sealer roll has been adjusted to that particular cover. The paper gasket cover will stand a little looser adjustment than will the rubber compound cover.

Inspect cans, lids and gaskets to be sure they are perfect. Discard cans that are badly bent, dented or rusty. Discard lids with damaged gaskets. Wash cans in clean hot water just before use. Drain upside down. Do not wash lids, as washing may damage the gaskets. If lids have become soiled, rinse them with clean water or wipe with a damp cloth when ready to place on cans.

Check to see that your can sealer is in good working order. Test by sealing a can containing a small amount of water. Submerge the sealed can in boiling water for a few seconds. If air bubbles rise from around the can, the seam is not tight. Readjust.

Exhaust Excess Air

Exhaust or drive out the excess air in the can by heating the contents to a minimum of 170°F (77°C). The product may already be that temperature if the hot-pack method is being used. Place open cans in pot; add boiling water to within 2" of the top of cans. Boil until the temperature of the food in the center of the can reads at least 170°F. This may take more than an hour if the raw-pack method is used.

Wipe off the rim of the can, place lid on can and seal at once, before the contents of the can cool.

Check to see the seaming rolls of your sealer are properly adjusted before sealing cans. For safety's sake, test a few cans from each batch for leaks by plunging hot cans into cold water. Air bubbles indicate an imperfect seal.

Cooling Cans After Processing

Tin cans should be removed from the cooker immediately after processing and placed in cold water. This stops the cooking and prevents discoloration of food. Change water frequently for fast cooling. Remove cans from water while they are still warm so they will air dry. To allow for air circulation, do not stack cans directly on top of one another.

A variety of canning problems can be traced to delayed cooling, such as flat sour in asparagus, beans, corn, spinach and peas; flavor and color deterioration in fruits and tomatoes; scorched flavor in tomatoes, corn, and sweet potatoes; and darkening of corn and kraut.

Testing The Seal

Check containers for leaks when thoroughly cool – about 12 hours. Examine seams and seals carefully on all cans. Can ends should be almost flat, with a slight inward curve. Occasionally, a can packed too full will bulge at the ends. Set it aside and use it within a few days so it doesn't get mistaken for a can that has bulged from spoilage during storage.

CANNING INSTRUCTIONS

IMPORTANT: Read carefully. Do not attempt to use your canner before reading these instructions. Follow these step-by-step instructions for pressure canning in your canner. Prepare food according to the directions in specific recipe.

- 1) Check metal-to-metal seal for lubrication, and that the vent pipe is clear. (See page 10) (Caring for your cooker section)
- 2) Pour 2-3" of water in cooker.
- 3) Place rack in bottom of the pressure cooker with the rim facing down when using pans, canning jars or tin cans. Never allow these containers to stand directly on the bottom of the cooker.
- 4) Place sealed cans or closed jars on rack in pressure cooker. Stagger the top layer if there are two layers of jars, using a rack between layers. (Note: Model 910 and 915 come with only one rack.)
- 5) Secure the lid to the cooker/canner using the instructions on page 9.
- 6) Place cooker/canner over heat source on high heat until a steady column of steam escapes from the vent pipe for 10 minutes before placing the pressure regulator weight on vent pipe.
- 7) If your recipe calls for cooking at 15 pounds, set pressure regulator weight over vent pipe at the hole marked with the number 15. If only 10 pounds pressure is required, place the hole marked with the number 10 over the vent pipe. (See Diagram G)
- 8) Start counting your processing time from the first jiggle or rock of the pressure regulator weight.
- 9) Adjust the heat until the pressure regulator weight jiggles only one to four times per minute. Never turn up the heat to the point that a constant flow of steam is escaping, thereby causing the pressure regulator weight to be constantly in the "up" position. (Watch the video demonstration at www.aa-cd.co)
- 10) Experience with the pressure regulator weight will teach you what setting on your stove will maintain the proper pressure and how long it takes before the pressure regulator weight jiggles or rocks. This will depend on which size pressure cooker/canner you have and how much food you are canning.
- 11) If steam escapes in a steady stream after you've reduced the heat, nudge the pressure regulator weight to set it properly.
- 12) When the food has cooked at the proper pressure for the correct period of time, turn off the heat source.
- 13) Read page 21 for reducing the pressure and removing the cover.



Diagram G

Reducing Pressure

WARNING: Steam escaping from the vent pipe can scald or burn you and the pressure regulator weight may be hot. Protect your hand with a pot holder or mitt.

When cooking is completed and heat is off, reduce pressure as follows:

- After canning in *glass jars*, turn heat off and permit cooker to cool gradually until the pressure dial gauge drops to zero. Remove the pressure regulator weight with a hot pad. Wait 2 minutes, and then unfasten cover by turning wing nuts counter-clockwise until the bolts are able to be flipped down. Remove the cover, raising farthest edge first to protect face and arms from steam.
- After canning in *tin cans*, turn heat off and release pressure as quickly as possible by removing the pressure regulator weight with a hot pad. Wait 2 minutes; unfasten cover by turning wing nuts counter-clockwise until the bolt is able to be flipped down. Remove the cover, raising farthest edge first to protect face and arms from steam.
- DO NOT put cold cloths or water on the cooker to hasten cooling. Forced cooling may result in food spoilage and may crack the aluminum.
- DO NOT move the pressure cooker until the pressure is completely reduced and pressure dial gauge reads ZERO.
- DO NOT loosen the wing nuts until the pressure dial gauge reads zero, and the remaining pressure has been exhausted by carefully removing the pressure regulator weight and you have waited 2 minutes
- When the pressure regulator weight is left on a long time after the pressure has been reduced to zero, a vacuum may form inside the cooker making the cover difficult to remove. To avoid a vacuum, you must remove the pressure regulator weight from the vent pipe as soon as the pressure dial gauge indicator reaches ZERO p.s.i. and then remove the cover after waiting 2 minutes. The longer you wait without removing the pressure regulator weight, the more vacuum will form, pulling the cover tighter and tighter to the bottom.
- Another reason that a cover sticks to the bottom is that the metal-to-metal seal has been permitted to build up a coating of lubrication or the seal was not lubricated at all. Please refer to page 10 for cleaning metal-to-metal seal.

Removing a “Stuck” Cover (due to vacuum)

- In the event that a vacuum forms, use a large standard screwdriver to pry the cover loose. Place the end of the screwdriver at an angle between the cover and bottom near a wing nut assembly. Do not go straight in with the screwdriver or you will damage the metal-to-metal seal. Gently pry upward using the screwdriver as a lever. Continue to pry upward at each wing nut assembly area uniformly so that the cover is raised evenly. In most cases, the cover should come off rather quickly. If you need further assistance, please call factory.

PREPARING FRUIT FOR CANNING

SYRUP

Adding syrup to canned fruit helps to retain its flavor, color, and shape. It does not prevent spoilage of these foods and is not really necessary. Fruit can be preserved in juice or water. Measure sugar and liquid (usually water or fruit juice) into saucepan. Bring to a boil and pour over raw fruits in jars. For hot packs, bring water and sugar to boil, add fruit, reheat to boil, and fill into jars immediately. About 1 cup syrup is usually needed for one quart of fruit.

Note: Mild-flavored honey or light corn syrups may be used to replace up to half the table sugar. See table below for ratios.

Syrup Type	Sweetener	Cups Sugar	Cups Water	Cups Yielded
Very Light		1¼	5½	6
Light		2¼	5¼	6½
Medium		3¼	5	7
Heavy		4¼	4¼	7
Corn Syrup	1 cup	1½	3	6
Honey	1 cup	1	4	5

APPLESAUCE

An average of 3 pounds per quart is needed. Select apples that are sweet, juicy, and crisp. For a tart flavor, add 1 to 2 pounds of tart apples to each 3 pounds of sweeter fruit. Wash, peel and core apples. If desired, slice apples into water containing ascorbic acid (3 grams per 1 gallon of cold water) to prevent browning. Place drained slices in an 8-10 quart pot. Add ½ cup water. Stir occasionally to prevent burning, heat quickly until tender (5 to 20 minutes, depending on maturity and variety). Press through a sieve or food mill, or skip the pressing step if you prefer chunk-style sauce. Sauce may be packed without sugar. If desired, add ⅓ cup sugar per quart of sauce. Taste and add more, if preferred. Reheat sauce to boiling. Fill jars with hot sauce, leaving ½-inch headspace. Adjust lids and process.

Process time for Applesauce			Weight Setting at Altitudes of	
Style of Pack	Jar Size	Process Time	0-1,000 ft	Above 1,000 ft
Hot	Pints	8 min	5 lb	10 lb
	Quarts	10 min	5 lb	10 lb

APPLES – SLICED

An average of 2¾ pounds per quart is needed. Select apples that are juicy, crispy, and preferably both sweet and tart. Wash, peel, and core apples. If desired, slice apples into water containing ascorbic acid (3 grams per 1 gallon of cold water) to prevent browning. Raw packs make poor quality products. Place drained slices in large saucepan and add 1 pint water or very light, light, or medium syrup per 5 pounds of sliced apples. Boil 5 minutes, stirring occasionally to prevent burning. Fill jars with hot sliced apples and hot syrup or water, leaving ½-inch headspace. Adjust lids and process.

Process time for Apples-Sliced			Weight Setting at Altitudes of	
Style of Pack	Jar Size	Process Time	0-1,000 ft	Above 1,000 ft
Hot	Pints or Quarts	8 min	5 lb	10 lb

APRICOTS

An average of 2 ¼ pounds is needed per quart. Select firm, well-colored mature fruit of ideal quality for eating fresh. Follow directions for peaches. The boiling water dip and removal of skin process is optional. Wash fruit if skins are not removed; use either hot or raw pack and the same process time. (See page 24 under peaches for process time)

BERRIES – WHOLE

Blackberries, blueberries, currants, dewberries, elderberries, gooseberries, huckle-berries, loganberries, mulberries, raspberries.

An average of 1½ pounds per quart is needed. Choose ripe, sweet berries with uniform color. Wash 1 or 2 quarts of berries at a time. Drain, cap, and stem if necessary. For gooseberries, snip off heads and tails with scissors. Prepare and boil preferred syrup if desired. Add ½ cup syrup, juice, or water to each clean jar.

Hot Pack – For blueberries, currants, elderberries, gooseberries, and huckleberries. Heat berries in boiling water for 30 seconds and drain. Fill jars and cover with hot juice, leaving ½-inch headspace.

Raw Pack – Fill jars with any of the raw berries, shaking down gently while filling. Cover with hot syrup, juice, or water, leaving ½-inch headspace.

Adjust lids and process.

Process time for Berries – Whole			Weight Setting at Altitudes of	
Style of Pack	Jar Size	Process Time	0-1,000 ft	Above 1,000 ft
Hot	Pints or Quarts	8 min	5 lb	10 lb
Raw	Pints	8 min	5 lb	10 lb
Raw	Quarts	10 min	5 lb	10 lb

CHERRIES – WHOLE (Sweet or Sour)

An average of 2½ pounds per quart is needed. Select bright, uniformly colored cherries that are mature (of ideal quality for eating fresh or cooking). Stem and wash cherries. Remove pits if desired. If pitted, place cherries in water containing ascorbic acid (3 grams per 1 gallon of cold water) to prevent browning and to prevent stem-end discoloration. If canned unpitted, prick skins on opposite sides with a clean needle to prevent splitting. Cherries may be canned in water, apple juice, white grape juice, or syrup. If syrup is desired, select and prepare preferred type as directed on page 22.

Hot Pack – In a large saucepan add ½ cup water, juice, or syrup for each quart of drained fruit and bring to boil. Fill jars with cherries and cooking liquid, leaving ½-inch headspace.

Raw Pack – Add ½ cup hot water, juice, or syrup to each jar. Fill jars with drained cherries, shaking down gently as you fill. Add more hot liquid, leaving ½-inch headspace.

Adjust lids and process.

Process time for Cherries – Whole			Weight Setting at Altitudes of	
Style of Pack	Jar Size	Process Time	0-1,000 ft	Above 1,000 ft
Hot	Pints	8 min	5 lb	10 lb
Hot	Quarts	10 min	5 lb	10 lb
Raw	Pints or Quarts	10 min	5 lb	10 lb

FRUIT PUREES (of any fruit except figs and tomatoes)

Stem, wash, drain, peel, and remove pits if necessary. Measure fruit into large saucepan, crushing slightly if desired. Add 1 cup hot water for each quart of fruit. Cook slowly until fruit is soft, stirring frequently. Press through sieve or food mill. If desired for flavor, add sugar to taste. Reheat pulp to boil, or until sugar dissolves if added. Fill hot into clean jars, leaving ¼-inch headspace. Adjust lids and process.

Process time for Fruit Purees			Weight Setting at Altitudes of	
Style of Pack	Jar Size	Process Time	0-1,000 ft	Above 1,000 ft
Hot	Pints or Quars	8 min	5 lb	10 lb

GRAPEFRUIT AND ORANGE SLICES

An average of about 2 pounds is needed per quart. Select firm, mature, sweet fruit of ideal quality for eating fresh. The flavor of orange sections is best if the sections are canned with equal parts of grapefruit. Grapefruit may be canned without oranges. Sections may be packed in your choice of water, citrus juice, or syrup.

Wash and peel fruit and remove white tissue to prevent a bitter taste. If you use syrup, prepare a very light, light, or medium syrup and bring to boil. Fill jars with sections and water, juice, or hot syrup, leaving ½-inch headspace. Adjust lids and process.

Process time for Grapefruit & Orange Slices			Weight Setting at Altitudes of	
Style of Pack	Jar Size	Process Time	0-1,000 ft	Above 1,000 ft
Hot	Pints or Quarts	8 min	5 lb	10 lb
Raw	Pints	8 min	5 lb	10 lb
Raw	Quarts	10 min	5 lb	10 lb

NECTARINES – HALVED OR SLICED

An average of 2½ pounds is needed per quart. Choose ripe, mature fruit of ideal quality for eating fresh or cooking. Follow directions for peaches except do not dip in hot water or remove skins. Wash fruit and use either hot or raw pack and the same process time. (use table below for peaches)

PEACHES – HALVED OR SLICED

An average of 2½ pounds is needed per quart. Choose ripe, mature fruit of ideal quality for eating fresh or cooking. Dip fruit in boiling water for 30 to 60 seconds until skins loosen. Dip quickly in cold water and slip off skins. Cut in half, remove pits and slice if desired. To prevent darkening, keep peeled fruit in an ascorbic acid solution (3 grams per 1 gallon of cold water). Prepare and boil a very light, light, or medium syrup, according to directions on page 22 or pack peaches in water, apple juice, or white grape juice. Raw packs make poor quality peaches.

Hot Pack – In a large saucepan place drained fruit in syrup, water, or juice and bring to boil. Fill jars with hot fruit and cooking liquid, leaving ½-inch headspace. Place halves in layers, cut side down.

Raw Pack – Fill jars with raw fruit, cut side down, and add hot water, juice or syrup, leaving ½-inch headspace. Adjust lids and process.

Process time for Peaches, Nectarines & Apricots			Weight Setting at Altitudes of	
Style of Pack	Jar Size	Process Time	0-1,000 ft	Above 1,000 ft
Hot and Raw	Pints or Quarts	10 min	5 lb	10 lb

PEARS – HALVED

An average of 2½ pounds is needed per quart. Choose ripe, mature fruit of ideal quality for eating fresh or cooking. Wash and peel pears. Cut lengthwise in halves and remove core. A melon baller or metal measuring spoon is suitable for coring pears. To prevent discoloration, keep pears in an ascorbic acid solution, (3 grams per 1 gallon of cold water). Prepare a very light, light, or medium syrup or pack pears in apple juice, white grape juice, or water. Raw packs make poor quality pears. Boil drained pears 5 minutes in syrup, juice, or water. Fill jars with hot fruit and cooling liquid, leaving ½-inch headspace. Adjust lids and process.

Process time for Pears – Halved			Weight Setting at Altitudes of	
Style of Pack	Jar Size	Process Time	0-1,000 ft	Above 1,000 ft
Hot	Pints or Quarts	10 min	5 lb	10 lb

PLUMS – HALVED OR WHOLE

An average of 2 pounds is needed per quart. Select deep-colored, mature fruit of ideal quality for eating fresh or cooking. Plums may be packed in water or syrup. Stem and wash plums. To can whole, prick skins on two sides of plums with fork to prevent splitting. Freestone varieties may be halved and pitted. If you use syrup, prepare very light, light, or medium syrup according to directions on page 22.

Hot Pack – Add plums to water or hot syrup and boil 2 minutes. Cover saucepan and let stand 20 to 30 minutes. Fill jars with hot plums and cooking liquid or syrup, leaving ½-inch headspace.

Raw Pack – Fill jars with raw plums, packing firmly. Add hot water or syrup leaving ½-inch headspace.

Adjust lids and process.

Process time for Plums – Halved or Whole			Weight Setting at Altitudes of	
Style of Pack	Jar Size	Process Time	0-1,000 ft	Above 1,000 ft
Hot and Raw	Pints or Quarts	10 min	5 lb	10 lb

RHUBARB – STEWED

An average of 1½ pounds is needed per quart. Select young, tender, well-colored stalks from the spring or late fall crop. Trim off leaves. Wash stalks and cut into ½-inch to 1-inch pieces. In a large saucepan add ½ cup sugar for each quart of fruit. Let stand until juice appears. Heat gently to boiling. Fill jars without delay, leaving ½-inch headspace. Adjust lids and process.

Process time for Rhubarb – Stewed			Weight Setting at Altitudes of	
Style of Pack	Jar Size	Process Time	0-1,000 ft	Above 1,000 ft
Hot	Pints or Quarts	8 min	5 lb	10 lb

PREPARING TOMATOES AND TOMATO PRODUCTS FOR CANNING

Select only disease-free, preferably vine-ripened, firm fruit for canning. **Caution: Do not can tomatoes from dead or frost-killed vines. Green tomatoes are more acidic than ripened fruit and can be canned safely with any of the following recommendations.**

Acidification: To ensure safe acidity in whole, crushed, or juiced tomatoes, add two tablespoons of bottled lemon juice or ½ teaspoon of citric acid per quart of tomatoes. For pints, use one tablespoon bottled lemon juice or ¼ teaspoon citric acid. Acid can be added directly to the jars before filling with product. Add sugar to offset acid taste, if desired. Four tablespoons of a 5 percent acidity vinegar per quart may be used instead of lemon juice or citric acid. However, vinegar may cause undesirable flavor changes.

Recommendation: Use of a pressure canner will result in higher quality and more nutritious canned tomato products.

TOMATO JUICE

An average of 3¼ pounds is needed per quart. Wash, remove stems, and trim off bruised or discolored portions. To prevent juice from separating, quickly cut about 1 pound of fruit into quarters and put directly into saucepan. Heat immediately to boiling while crushing. Continue to slowly add and crush freshly cut tomato quarters to the boiling mixture. Make sure the mixture boils constantly and vigorously while you add the remaining tomatoes. Simmer 5 minutes after you add all pieces.

If you are not concerned about juice separation, simply slice or quarter tomatoes into a large saucepan. Crush, heat, and simmer for 5 minutes before juicing.

Press both types of heated juice through a sieve or food mill to remove skins and seeds. **Add bottled lemon juice or citric acid to jars.** See acidification instructions above. Heat juice again to boiling. Add 1 teaspoon of salt per quart to the jars, if desired. Fill jars with hot tomato juice, leaving ½-inch headspace. Adjust lids and process.

Process time for Tomato Juice			Weight Setting at Altitudes of	
Style of Pack	Jar Size	Process Time	0-1,000 ft	Above 1,000 ft
Hot	Pints or Quarts	20 min	5 lb	10 lb
		15 min	10 lb	15 lb
		10 min	15 lb	Not Recommended

TOMATO JUICE AND VEGETABLE JUICE BLEND

An average of 22 pounds of tomatoes is needed per canner load of 7 quarts. Not more than 3 cups of other vegetables may be added for each 22 pounds of tomatoes.

Crush and simmer tomatoes as for making tomato juice, see above. Add no more than 3 cups of any combination finely chopped celery, onions, carrots, and peppers for each 22 pounds of tomatoes. Simmer mixture 20 minutes. Press hot cooked tomatoes and vegetables through a sieve or food mill to remove skins and seeds. Add bottled lemon juice or citric acid to jars. See acidification directions above. Add 1 teaspoon of salt per quart to the jars, if desired. Reheat tomato-vegetable juice blend to boiling and fill immediately into jars, leaving ½-inch headspace. Adjust lids and process.

Process time for Tomato and Vegetable Juice Blend			Weight Setting at Altitudes of	
Style of Pack	Jar Size	Process Time	0-1,000 ft	Above 1,000 ft
Hot	Pints or Quarts	20 min	5 lb	10 lb
		15 min	10 lb	15 lb
		10 min	15 lb	Not Recommended

TOMATOES – CRUSHED (with no added liquid)

A high-quality product, ideally suited for use in soups, stews, and casseroles. An average of 2¾ pounds is needed per quart. Wash tomatoes and dip in boiling water for 30 to 60 seconds or until skins split. Then dip in cold water, slip off skins, and remove cores. Trim off any bruised or discolored portions and quarter.

Heat ⅓ of the quarters quickly in a large pot, crushing them with a wooden mallet or spoon as they are added to the pot. This will exude juice. Continue heating the tomatoes, stirring to prevent burning. Once the tomatoes are boiling, gradually add remaining quartered tomatoes, stirring constantly. These remaining tomatoes do not need to be crushed. They will soften with heating and stirring. Continue until all tomatoes are added. Then boil gently 5 minutes. **Add bottled lemon juice or citric acid to jars.** See acidification directions on page 26. Add 1 teaspoon of salt per quart to the jars, if desired. Fill jars immediately with hot tomatoes, leaving ½-inch headspace. Adjust lids and process.

Process time for Crushed Tomatoes			Weight Setting at Altitudes of	
Style of Pack	Jar Size	Process Time	0-1,000 ft	Above 1,000 ft
Hot	Pints or Quarts	20 min	5 lb	10 lb
		15 min	10 lb	15 lb
		10 min	15 lb	Not Recommended

STANDARD TOMATO SAUCE

For thin sauce, an average of 5 pounds is needed per quart. For thick sauce, an average of 6½ pounds is needed per quart. Prepare and press as for making tomato juice, see page 26. **Simmer** in large-diameter saucepan until sauce reaches desired consistency. Boil until volume is reduced by about one-third for thin sauce, or by one-half for thick sauce. **Add bottled lemon juice or citric acid to jars.** See acidification directions on page 26. Add 1 teaspoon of salt per quart to the jars, if desired. Fill jars, leaving ¼-inch headspace. Adjust lids and process.

Process time for Standard Tomato Sauce			Weight Setting at Altitudes of	
Style of Pack	Jar Size	Process Time	0-1,000 ft	Above 1,000 ft
Hot	Pints or Quarts	20 min	5 lb	10 lb
		15 min	10 lb	15 lb
		10 min	15 lb	Not Recommended

TOMATOES – WHOLE OR HALVED (packed in water)

An average of 3 pounds is needed per quart. Wash tomatoes. Dip in boiling water for 30 to 60 seconds or until skins split; then dip in cold water. Slip off skins and remove cores. Leave whole or halve. **Add bottled lemon juice or citric acid to jars.** See acidification directions on page 26. Add 1 teaspoon of salt per quart to the jars, if desired. For hot pack products, add enough water to cover the tomatoes and boil them gently for 5 minutes. Fill jars with hot tomatoes or with raw peeled tomatoes. Add the hot cooking liquid to the hot pack, or hot water for raw pack to cover, leaving ½-inch headspace. Adjust lids and process.

Process time for Water-Packed Tomatoes			Weight Setting at Altitudes of	
Style of Pack	Jar Size	Process Time	0-1,000 ft	Above 1,000 ft
Hot and Raw	Pints or Quarts	15 min	5 lb	10 lb
		10 min	10 lb	15 lb
		1 min	15 lb	Not Recommended

TOMATOES – WHOLE OR HALVED (packed in tomato juice)

An average of 3 pounds is needed per quart. Wash tomatoes. Dip in boiling water for 30 to 60 seconds or until skins split, then dip in cold water. Slip off skins and remove cores. Leave whole or halve. **Add bottled lemon juice or citric acid to jars.** See acidification instructions on page 26. Add 1 teaspoon of salt per quart to the jars, if desired.

Raw Pack – Heat tomato juice in a saucepan. Fill jars with raw tomatoes, leaving ½-inch headspace. Cover tomatoes in the jars with hot tomato juice, leaving ½-inch headspace.

Hot Pack – Put tomatoes in a large saucepan and add enough tomato juice to completely cover them. Boil tomatoes and juice gently for 5 minutes. Fill jars with hot tomatoes, leaving ½-inch headspace. Add hot tomato juice to the jars to cover the tomatoes, leaving ½-inch headspace. Adjust lids and process.

Process time for Juice and Whole Tomatoes			Weight Setting at Altitudes of	
Style of Pack	Jar Size	Process Time	0-1,000 ft	Above 1,000 ft
Hot and Raw	Pints or Quarts	40 min	5 lb	10 lb
		25 min	10 lb	15 lb
		15 min	15 lb	Not Recommended

TOMATOES – WHOLE OR HALVED (packed raw without added liquid)

An average of 3 pounds is needed per quart. Wash tomatoes. Dip in boiling water for 30 to 60 seconds or until skins split, then dip in cold water. Slip off skins and remove cores. Leave whole or halve. **Add bottled lemon juice or citric acid to jars.** See acidification instructions on page 26. Add 1 teaspoon of salt per quart to the jars, if desired. Fill jars with raw tomatoes, leaving ½-inch headspace. Press tomatoes in the jars until spaces between them fill with juice. Leave ½-inch headspace. Adjust lids and process.

Process time for Tomatoes w/o Added Liquid			Weight Setting at Altitudes of	
Style of Pack	Jar Size	Process Time	0-1,000 ft	Above 1,000 ft
Raw	Pints or Quarts	40 min	5 lb	10 lb
		25 min	10 lb	15 lb
		15 min	15 lb	Not Recommended

SPAGHETTI SAUCES

SPAGHETTI SAUCE WITHOUT MEAT

30 lbs tomatoes

1 cup chopped onions

5 cloves garlic, minced

1 cup chopped celery or green pepper

1 lb fresh mushrooms, sliced (optional)

4½ tsp salt

2 tbsp oregano

4 tbsp minced parsley

2 tsp black pepper

¼ cup brown sugar

¼ cup vegetable oil

Makes about 9 pints

Caution: Do not increase the proportion of onions, peppers, or mushrooms. Wash tomatoes and dip in boiling water for 30 to 60 seconds or until skins split. Dip in cold water and slip off skins. Remove cores and quarter tomatoes. Boil 20 minutes, uncovered, in large saucepan. Put through food mill or sieve. Sauté onions, garlic, celery or peppers, and mushrooms (if desired) in vegetable oil until tender. Combine sautéed vegetables and tomatoes and add remainder of spices, salt, and sugar. Bring to a boil. Simmer, uncovered, until thick enough for serving. At this time the initial volume will have been reduced by nearly one-half. Stir frequently to avoid burning. Fill jars, leaving 1-inch headspace. Adjust lids and process.

Process time for Spaghetti Sauce w/o Meat			Weight Setting at Altitudes of	
Style of Pack	Jar Size	Process Time	0-1,000 ft	Above 1,000 ft
Hot	Pints	20 min	10 lb	15 lb
	Quarts	25 min	10 lb	15 lb

SPAGHETTI SAUCE WITH MEAT

30 lbs tomatoes

2½ lbs ground beef or sausage

1 cup chopped onions

5 cloves garlic, minced

1 cup chopped celery or green pepper

1 lb fresh mushrooms, sliced (optional)

4½ tsp salt

2 tbsp oregano

4 tbsp minced parsley

2 tsp black pepper

¼ cup brown sugar

Makes about 9 pints

To prepare tomatoes, follow directions for Spaghetti Sauce Without Meat, page 29. Saute beef or sausage until brown. Add garlic, onion, celery or green pepper, and mushrooms, if desired. Cook until vegetables are tender. Combine with tomato pulp in large saucepan. Add spices, salt, and sugar. Bring to a boil. Simmer, uncovered, until thick enough for serving. At this time initial volume will have been reduced by nearly one-half. Stir frequently to avoid burning. Fill jars, leaving 1-inch headspace. Adjust lids and process.

Process time for Spaghetti Sauce With Meat			Weight Setting at Altitudes of	
Style of Pack	Jar Size	Process Time	0-1,000 ft	Above 1,000 ft
Hot	Pints	60 min	10 lb	15 lb
	Quarts	70 min	10 lb	15 lb

PREPARING POULTRY, RED MEATS AND SEAFOODS FOR CANNING

Directions for canning cut-up meat applies to beef, veal, pork, lamb, mutton, and meat from large game animals. Use only good quality meat. It is essential to use absolutely fresh meat from animals that are healthy and have been butchered and handled in a sanitary manner.

If meat must be held longer than a few days, freeze it. Store frozen meat at temperatures of 0°F (-18°C) or lower until canning time. Cut or saw frozen meat into pieces of desired size. If frozen meat is thawed before canning, thaw it in a refrigerator at a temperature of 40°F (4°C) or lower until most of the ice crystals have disappeared.

When canning meat, take special care to keep all utensils and equipment as clean as possible. Scrub pans, knives and kitchen tools in hot soapy water and rinse well with boiling water.

Tender cuts of meat can be canned in large pieces; less tender cuts and small pieces are good candidates for stew meat or ground meat. Bones are good for soups. Meat can be raw- packed or cooked and hot-packed as plain or rolled roasts, steaks, soups and stews, meat loaf, hash, chili or mincemeat.

To prepare broth, place bony pieces in saucepan and cover with cold water. Simmer until meat is tender. Discard fat. Add boiling broth to jars packed with precooked meat and poultry.

Do not use flour on meat or in gravy when it is to be canned. The flour forms a coating of starch that makes sterilization difficult. For thick gravy, add flour after jar or can is opened for use.

Always pack liver separately, as it will flavor everything else in the container.

CHICKEN OR RABBIT

Procedure: Choose freshly killed and dressed, healthy animals. Large chickens are more flavorful than fryers. Dressed chicken should be chilled for 6 to 12 hours before canning. Dressed rabbits should be soaked 1 hour in water containing 1 tablespoon of salt per quart, and then rinsed. Remove excess fat. Cut the chicken or rabbit into suitable sizes for canning. Can with or without bones.

Hot Pack – Boil, steam, or bake meat until about two-thirds done. Add 1 teaspoon salt per quart to the jar, if desired. Fill hot jars with pieces and hot broth, leaving 1¼ - inch headspace.

Raw Pack – Add 1 teaspoon salt per quart, if desired. Fill hot jars loosely with raw meat pieces, leaving 1¼ - inch headspace. Do not add liquid. Adjust lids and process.

Process time for Chicken or Rabbit			Weight Setting at Altitudes of	
Style of Pack	Jar Size	Process Time	0-1,000 ft	Above 1,000 ft
Without Bones: Hot and Raw	Pints	75 min	10 lb	15 lb
	Quarts	90 min	10 lb	15 lb
With Bones: Hot and Raw	Pints	65 min	10 lb	15 lb
	Quarts	75 min	10 lb	15 lb

GROUND OR CHOPPED MEAT (Bear, Beef, Lamb, Pork, Sausage, Veal, Venison)

Procedure: Choose fresh, chilled meat. With venison, add one part high-quality pork fat to three or four parts venison before grinding. Use freshly made sausage, seasoned with salt and cayenne pepper (sage may cause a bitter off-flavor). Shape chopped meat into patties or balls or cut cased sausage into 3 to 4 inch links. Cook until lightly browned. Ground meat may be sautéed without shaping. Remove excess fat. Fill hot jars with pieces. Add boiling meat broth, tomato juice or water, leaving 1-inch headspace. Add 1 teaspoon of salt per quart to the jars, if desired. Adjust lids and process.

Process time for Ground or Chopped Meat			Weight Setting at Altitudes of	
Style of Pack	Jar Size	Process Time	0-1,000 ft	Above 1,000 ft
Hot	Pints	75 min	10 lb	15 lb
	Quarts	90 min	10 lb	15 lb

STRIPS, CUBES OR CHUNKS OF MEAT (Bear, Beef, Lamb, Pork, Sausage, Veal, Venison)

Procedure: Choose quality chilled meat. Remove excess fat. Soak strong-flavored wild meats for 1 hour in brine water containing 1 tablespoon of salt per quart. Rinse. Remove large bones.

Hot Pack – Precook meat until rare by roasting, stewing, or browning in a small amount of fat. Add 1 teaspoon of salt per quart to the jar, if desired. Fill hot jars with pieces and add boiling broth, meat drippings, water, or tomato juice (especially with wild game), leaving 1-inch headspace.

Raw Pack – Add 1 teaspoon of salt per quart to the jar, if desired. Fill hot jars with raw meat pieces, leaving 1-inch headspace. Do not add liquid. Adjust lids and process.

Process time for Strips, Cubes or Chunks of Meat			Weight Setting at Altitudes of	
Style of Pack	Jar Size	Process Time	0-1,000 ft	Above 1,000 ft
Hot and Raw	Pints	75 min	10 lb	15 lb
	Quarts	90 min	10 lb	15 lb

MEAT STOCK (BROTH)

Beef: Saw or crack fresh trimmed beef bones to enhance extraction of flavor. Rinse bones and place in a large stockpot or kettle, cover bones with water, add pot cover and simmer 3 to 4 hours. Remove bones, cool broth, and pick off meat. Skim off fat, add meat removed from bones to broth, and reheat to boiling. Fill hot jars, leaving 1-inch headspace. Adjust lids and process..

Chicken or turkey: Place large carcass bones in a large stockpot, add enough water to cover bones, cover pot, and simmer 30 to 45 minutes or until meat can be easily stripped from bones. Remove bones and pieces, cool broth, strip meat, discard excess fat, and return meat to broth. Reheat to boiling and fill hot jars, leaving 1-inch headspace. Adjust and process.

Process time for Meat Stock			Weight Setting at Altitudes of	
Style of Pack	Jar Size	Process Time	0-1,000 ft	Above 1,000 ft
Hot	Pints	20 min	10 lb	15 lb
	Quarts	25 min	10 lb	15 lb

CHILE CON CARNE

3 cups dried pinto or red kidney beans

5½ cups water

5 tsp salt (separated)

3 lbs ground beef

1½ cups chopped onions

1 cup chopped peppers of your choice (optional)

1 tsp black pepper

3 to 6 tbsp chili powder

2 qts crushed or whole tomatoes

Makes about 9 pints

Procedure: Wash beans thoroughly and place them in a 2 qt. saucepan. Add cold water to a level of 2 to 3 inches above the beans and soak 12 to 18 hours. Drain and discard water. Combine beans with 5½ cups of fresh water and 2 teaspoons salt. Bring to a boil. Reduce heat and simmer 30 minutes. Drain and discard water. Brown ground beef, chopped onions, and peppers, if desired, in a skillet. Drain off fat and add 3 teaspoons salt, pepper, chili powder, tomatoes and drained cooked beans. Simmer 5 minutes. **Caution: Do not thicken.** Fill hot jars, leaving 1-inch headspace. Adjust lids and process.

Process time for Chile Con Carne			Weight Setting at Altitudes of	
Style of Pack	Jar Size	Process Time	0-1,000 ft	Above 1,000 ft
Hot	Pints	75 min	10 lb	15 lb

CLAMS (Whole or minced)

Procedure: Keep clams live on ice until ready to can. Scrub shells thoroughly and rinse, steam 5 minutes, and open. Remove clam meat. Collect and save clam juice. Wash clam meat in water containing 1 teaspoon of salt per quart. Rinse and cover clam meat with boiling water containing 2 tablespoons of lemon juice or ½ teaspoon of citric acid per gallon. Boil 2 minutes and drain. To make mince clams, grind clams with a meat grinder or food processor. Fill hot jars loosely with pieces and add hot clam juice and boiling water if needed, leaving 1-inch headspace. Adjust lids and process.

Process time for Clams			Weight Setting at Altitudes of	
Style of Pack	Jar Size	Process Time	0-1,000 ft	Above 1,000 ft
Hot	Half-pints	60 min	10 lb	15 lb
	Pints	70 min	10 lb	15 lb

KING AND DUNGENESS CRAB MEAT (It is recommended that blue crab meat be frozen for best quality)

Procedure: Keep live crabs on ice until ready to can. Wash crabs thoroughly, using several changes of cold water. Simmer crabs 20 minutes in water containing ¼ cup of lemon juice and 2 tablespoons of salt (or up to 1 cup of salt, if desired) per gallon. Cool in cold water, drain, remove back shell, then remove meat from body and claws. Soak meat 2 minutes in cold water containing 2 cups of lemon juice or 4 cups of white vinegar, and 2 tablespoons of salt (or up to 1 cup of salt, if desired) per gallon. Drain and squeeze meat to remove excess moisture. Fill hot half-pint jars with 6 ounces of meat and hot pint jars with 12 ounces, leaving 1-inch headspace. Add ½ teaspoon of citric acid or 2 tablespoons of lemon juice to each half-pint jar, or 1 teaspoon of citric acid or 4 tablespoons of lemon juice per pint jar. Add hot water, leaving 1-inch headspace. Adjust lids and process.

Process time for King and Dungeness Crab Meat		Weight Setting at Altitudes of	
Jar Size	Process Time	0-1,000 ft	Above 1,000 ft
Half-pints	70 min	10 lb	15 lb
Pints	80 min	10 lb	15 lb

FISH (Blue, mackerel, salmon, steelhead, trout, and other fatty fish except tuna)

Caution: Eviscerate fish within 2 hours after they are caught. Keep cleaned fish on ice until ready to can.

Note: Glass-like crystals of magnesium ammonium phosphate sometimes form in canned salmon. There is no way for the home canner to prevent these crystals from forming, but they usually dissolve when heated and are safe to eat. Adjust lids and process.

Procedure: Remove head, tail, fins, and scales. Wash and remove all blood. Split fish lengthwise, if desired. Cut cleaned fish into 3½-inch lengths. Fill hot pint jars, skin side next to glass, leaving 1-inch headspace. Add 1 teaspoon of salt per pint, if desired. Do not add liquids. Adjust lids and process.

Process time for Fish			Weight Setting at Altitudes of	
Style of Pack	Jar Size	Process Time	0-1,000 ft	Above 1,000 ft
Raw	Pints	100 min	10 lb	15 lb

SMOKED FISH (Salmon, rockfish and flatfish (sole, cod, flounder) and other fish)

Caution: Safe processing times for other smoked seafood have not been determined. Those products should be frozen. Smoking of fish should be done by tested methods. Lightly smoked fish is recommended for canning. However, because it has not yet been cooked, do not taste lightly smoked fish before canning.

Follow these recommended canning instructions carefully. Use a 16 quart or larger pressure canner for this procedure; do not use smaller pressure canners. Safe processing times haven't been determined. Do not use quart jars or tin cans. Half-pints could be safely processed for the same length of time as pints, but the quality of the product may be less acceptable.

Procedure: If smoked fish has been frozen, thaw in the refrigerator until no ice crystals remain before canning. If not done prior to smoking, cut fish into pieces that will fit vertically into pint canning jars, leaving 1-inch headspace. Measure 4 quarts (16 cups) of cool tap water and pour into the pressure canner. (**Note:** The water level probably will reach the screw bands of pints jars.) **Do not decrease the amount of water or heat the water before processing begins.** Pack smoked fish vertically into hot jars, leaving 1-inch headspace between the pieces and the top of the jar. The fish may be packed either loosely or tightly. Clean jar rims with a clean, damp paper towel. Do not add liquid to the jars. Adjust lids and process.

Process time for Smoked Fish		Weight Setting at Altitudes of	
Jar Size	Process Time	0-1,000 ft	Above 1,000 ft
Pints	110 min	10 lb	15 lb

TUNA

Tuna may be canned either precooked or raw. Precooking removes most of the strong-flavored oils. The strong flavor of dark tuna flesh affects the delicate flavor of white flesh. Many people prefer not to can dark flesh. It may be used as pet food.

Note: Glass-like crystals of magnesium ammonium phosphate sometimes form in canned tuna. There is no way for the home canner to prevent these crystals from forming, but they usually dissolve when heated and are safe to eat.

Procedure: Keep tuna on ice until ready to can. Remove viscera and wash fish well in cold water. Allow blood to drain from stomach cavity. Place fish belly down on a rack or metal tray in the bottom of a large baking pan. Cut tuna in half crosswise, if necessary. Precook fish by baking at 250°F for 2½ to 4 hours (depending on size) or at 350°F for 1 hour. The fish may also be cooked in a steamer for 2 to 4 hours. If a thermometer is used, cook to a 165° to 175°F internal temperature. Refrigerate cooked fish overnight to firm the meat. Peel off the skin with a knife, removing blood vessels and any discolored flesh. Cut meat away from bones; cut out and discard all bones, fin bases, and dark flesh. Quarter. Cut quarters crosswise into lengths suitable for half-pint or pint jars. Fill into hot jars, pressing down gently to make a solid pack. Tuna may be packed in water or oil, whichever is preferred. Add water or oil to jars, leaving 1-inch headspace. Add ½ teaspoon of salt per half-pint or 1 teaspoon of salt per pint, if desired. Adjust lids and process.

Process time for Tuna		Weight Setting at Altitudes of	
Jar Size	Process Time	0-1,000 ft	Above 1,000 ft
Half-pints or Pints	100 min	10 lb	15 lb

PREPARING VEGETABLES FOR CANNING

ASPARAGUS – SPEARS OR PIECES

An average of 3½ pounds per quart is needed. Use tender, tight-tipped spears, 4-6 inches long. Wash asparagus and trim off tough scales. Break off tough stems and wash again. Cut into 1-inch pieces or can whole.

Hot Pack – Cover asparagus with boiling water. Boil 2 or 3 minutes. Loosely fill hot jars with hot asparagus, leaving 1-inch headspace.

Raw Pack – Fill hot jars with raw asparagus, packing as tightly as possible without crushing, leaving 1-inch headspace.

Add ½ teaspoon salt to each pint jar, 1 teaspoon of salt to each quart jar, if desired. Ladle boiling water, leaving 1-inch headspace. Remove air bubbles. Adjust lids and process.

Process time for Asparagus			Weight Setting at Altitudes of	
Style of Pack	Jar Size	Process Time	0-1,000 ft	Above 1,000 ft
Hot and Raw	Pints	30 min	10 lb	15 lb
	Quarts	40 min	10 lb	15 lb

BEANS OR PEAS – SHELLED, DRIED (All varieties)

An average of ¾ pounds is needed per quart. Select mature, dry seeds. Sort out and discard discolored seeds. Place dried beans or peas in a large pot and cover with water. Soak 12 to 18 hours in a cool place. Drain water. To quickly hydrate beans, you may cover sorted and washed beans with boiling water in a saucepan. Boil 2 minutes, remove water and boil 30 minutes. Add ½ teaspoon of salt per pint or 1 teaspoon per quart to the jar, if desired. Fill hot jars with beans or peas and cooking water, leaving 1-inch head space. Adjust lids and process.

Process time for Beans or Peas			Weight Setting at Altitudes of	
Style of Pack	Jar Size	Process Time	0-1,000 ft	Above 1,000 ft
Hot	Pints	75 min	10 lb	15 lb
	Quarts	90 min	10 lb	15 lb

BEANS, DRY, WITH TOMATO OR MOLASSES SAUCE

An average of ¾ pounds is needed per quart. Select mature, dry seeds. Sort out and discard discolored seeds. Sort and wash dry beans. Add 3 cups of water for each cup of dried beans or peas. Boil 2 minutes, remove from heat and soak 1 hour and drain. Heat to boiling in fresh water, and save liquid for making sauce. Make your choice of the following sauces:

Tomato Sauce – Either mix 1 quart tomato juice, 3 tablespoons sugar, 2 teaspoons salt, 1 tablespoon chopped onion, and ¼ teaspoon each of ground cloves, allspice, mace, and cayenne pepper; or mix 1 cup tomato ketchup with 3 cups of cooking liquid from beans and heat to boiling.

Molasses Sauce – Mix 4 cups water or cooking liquid from beans, 3 tablespoons dark molasses, 1 tablespoon vinegar, 2 teaspoons salt, and ¾ teaspoon powdered dry mustard. Heat to boiling.

Fill hot jars three-fourths full with hot beans. Add a ¾-inch cube of pork, ham, or bacon to each jar, if desired. Fill jars with heated sauce, leaving 1-inch headspace. Adjust lids and process.

Process time for Beans w/ Tomato or Molasses Sauce			Weight Setting at Altitudes of	
Style of Pack	Jar Size	Process Time	0-1,000 ft	Above 1,000 ft
Hot	Pints	65 min	10 lb	15 lb
	Quarts	75 min	10 lb	15 lb

BEANS, SNAP AND ITALIAN - PIECES (Green and wax)

An average of 2 pounds is needed per quart; an average of 1 pound is needed per pint. Select filled but tender, crisp pods. Remove and discard diseased and rusty pods. Wash beans and trim ends. Leave whole or cut or snap into 1-inch pieces.

Hot Pack – Cover beans with boiling water; boil 5 minutes. Fill hot jars loosely, leaving 1-inch headspace.

Raw Pack – Fill hot jars tightly with raw beans, leaving 1-inch headspace. Add 1 teaspoon of canning salt per quart to the jar, if desired. Add boiling water, leaving 1-inch headspace. Adjust lids and process.

Process time for Snap and Italian Beans			Weight Setting at Altitudes of	
Style of Pack	Jar Size	Process Time	0-1,000 ft	Above 1,000 ft
Hot and Raw	Pints	20 min	10 lb	15 lb
	Quarts	25 min	10 lb	15 lb

BEANS, FRESH LIMA – SHELLED

An average of 4 pounds is needed per quart. Select well-filled pods with green seeds. Discard insect-damaged and diseased seeds. Shell beans and wash thoroughly.

Hot Pack – Cover beans with boiling water and heat to boil. Fill hot jars loosely, leaving 1-inch headspace.

Raw Pack – Fill hot jars with raw beans. Do not press or shake down.

Small beans – leave 1-inch of headspace for pints and 1½-inches for quarts.

Large beans – leave 1-inch of headspace for pints and 1¼-inches for quarts.

Add 1 teaspoon of salt per quart to the jar, if desired. Add boiling water, leaving the same headspaces listed above. Adjust lids and process.

Process time for Lima Beans			Weight Setting at Altitudes of	
Style of Pack	Jar Size	Process Time	0-1,000 ft	Above 1,000 ft
Hot and Raw	Pints	40 min	10 lb	15 lb
	Quarts	50 min	10 lb	15 lb

BEETS

An average of 3 pounds is needed per quart. Beets with a diameter of 1 to 2 inches are preferred for whole packs. Beets larger than 3 inches in diameter are often fibrous. Trim off beet top, leaving an inch of stem and roots to reduce bleeding of color. Scrub well. Cover with boiling water. Boil until skins slip off easily; about 15 to 25 minutes depending on size. Cool, remove skins, and trim off stems and roots. Leave baby beets whole. Cut medium or large beets in to ½ inch cubes or slices. Halve or quarter very large slices. Add 1 teaspoon of salt per quart to the jar, if desired. Fill hot jars with hot beets and fresh hot water, leaving 1-inch headspace. Adjust lids and process.

Process time for Beets			Weight Setting at Altitudes of	
Style of Pack	Jar Size	Process Time	0-1,000 ft	Above 1,000 ft
Hot	Pints	30 min	10 lb	15 lb
	Quarts	35 min	10 lb	15 lb

CARROTS – SLICED OR DICED

An average of 2½ pounds is needed per quart. Select small carrots, preferably 1 to 1¼ inches in diameter. Larger carrots are often too fibrous. Wash, peel, and rewash carrots. Slice or dice.

Hot Pack – Cover with boiling water; bring to boil and simmer for 5 minutes. Fill hot jars, leaving 1-inch of headspace.

Raw Pack – Fill hot jars tightly with raw carrots, leaving 1-inch headspace.

Add 1 teaspoon of salt per quart to the jar, if desired. Add hot cooking liquid or water, leaving 1-inch headspace. Adjust lids and process.

Process time for Carrots			Weight Setting at Altitudes of	
Style of Pack	Jar Size	Process Time	0-1,000 ft	Above 1,000 ft
Hot and Raw	Pints	25 min	10 lb	15 lb
	Quarts	30 min	10 lb	15 lb

CORN – CREAM STYLE

An average of 2¼ pounds is needed per pint. Select ears containing slightly immature kernels, or of ideal quality for eating fresh. Husk corn, remove silk, and wash ears. Blanch ears 4 minutes in boiling water. Cut corn from cob at about the center of kernel. Scrape remaining corn from cobs with a table knife.

Hot Pack – To each quart of corn and scrapings, add two cups of boiling water. Heat to boiling. Add ½ teaspoon salt to each jar, if desired. Fill hot pint jar with hot corn mixture, leaving 1-inch headspace.

Process time for Cream Style Corn			Weight Setting at Altitudes of	
Style of Pack	Jar Size	Process Time	0-1,000 ft	Above 1,000 ft
Hot	Pints	85 min	10 lb	15 lb

CORN – WHOLE KERNEL

An average of 4½ pounds is needed per quart. Select ears containing slightly immature kernels or of ideal quality for eating fresh. Canning of some sweeter varieties or too immature kernels may cause browning. Can a small amount, check color and flavor before canning large quantities. Husk corn, remove silk, and wash. Blanch 3 minutes in boiling water. Cut corn from cob at about three-fourths the depth of kernel. Do not scrape cob.

Hot Pack – To each clean quart of kernels in a saucepan, add 1 cup of hot water, heat to boiling and simmer 5 minutes. Add 1 teaspoon of salt per quart to the jar, if desired. Fill hot jars with corn and cooking liquid, leaving 1-inch headspace.

Raw Pack – Fill hot jars with raw kernels, leaving 1-inch headspace. Do not shake or press down. Add 1 teaspoon of salt per quart to the jar, if desired.

Add fresh boiling water, leaving 1-inch headspace. Adjust lids and process.

Process time for Whole Kernel Corn			Weight Setting at Altitudes of	
Style of Pack	Jar Size	Process Time	0-1,000 ft	Above 1,000 ft
Hot and Raw	Pints	55 min	10 lb	15 lb
	Quarts	85 min	10 lb	15 lb

OKRA

An average of 1½ pounds is needed per quart. Select young tender pods. Remove and discard diseased and rust-spotted pods. Wash pods and trim ends. Leave whole or cut into 1-inch pieces. Cover with hot water in a saucepan, boil 2 minutes and drain. Fill hot jars with hot okra and cooking liquid, leaving 1-inch headspace. Add 1 teaspoon of salt per quart to the jar, if desired. Adjust lids and process.

Process time for Okra			Weight Setting at Altitudes of	
Style of Pack	Jar Size	Process Time	0-1,000 ft	Above 1,000 ft
Hot	Pints	25 min	10 lb	15 lb
	Quarts	40 min	10 lb	15 lb

PEAS, GREEN OR ENGLISH – SHELLED

It is recommended that sugar snap and Chinese edible pods be frozen for best quality.

An average of 4½ pounds is needed per quart. Select filled pods containing young, tender sweet seeds. Discard diseased pods. Shell and wash peas. Add 1 teaspoon of salt per quart to the jar, if desired.

Hot Pack – Cover with boiling water. Bring to boil in a saucepan, and boil 2 minutes. Fill hot jars loosely with hot peas, and add cooking liquid, leaving 1-inch of headspace. Adjust lids and process.

Raw Pack – Fill hot jars tightly with raw peas, adding boiling water, leaving 1-inch headspace. Do not shake or press down peas. Adjust lids and process.

Process time for Peas			Weight Setting at Altitudes of	
Style of Pack	Jar Size	Process Time	0-1,000 ft	Above 1,000 ft
Hot and Raw	Pints or Quarts	40 min	10 lb	15 lb

PEPPERS (Hot or sweet, including chilies, jalapeno, and pimento)

An average of 1 pound is needed per pint. Select firm yellow, green, or red peppers. Do not use soft or diseased peppers. Select your favorite pepper(s). **Caution: If you choose hot peppers, wear plastic gloves while handling them or wash hands thoroughly with soap and water before touching your face.** Small peppers may be left whole. Large peppers may be quartered. Remove cores and seeds. Slash two or four slits in each pepper, and either blanch in boiling water or blister using one of the following methods:

Oven or broiler method: Place peppers in a hot oven (400° F) or broiler for 6-8 minutes until skins blister.

Range-top method: Cover hot burner, either gas or electric, with heavy wire mesh. Place peppers on burner for several minutes until skins blister.

Allow peppers to cool. Place in a pan and cover with a damp cloth. This will make peeling the peppers easier. After several minutes, peel each pepper. Flatten whole peppers. Add ½ teaspoon of salt to each pint jar, if desired. Fill hot jars loosely with peppers and add fresh boiled water, leaving 1-inch headspace. Adjust lids and process.

Process time for Peppers			Weight Setting at Altitudes of	
Style of Pack	Jar Size	Process Time	0-1,000 ft	Above 1,000 ft
Hot	Half-pints or Pints	35 min	10 lb	15 lb

POTATOES, SWEET – PIECES OR WHOLE

It is not recommended to dry pack sweet potatoes. An average of 2½ pounds is needed per quart. Choose small to medium-sized potatoes. They should be mature and not too fibrous. Can within 1 to 2 months after harvest. Wash potatoes and boil or steam until partially soft (15 to 20 minutes). Remove skins. Cut medium potatoes, if needed, so that pieces are uniform in size. **Caution: Do not mash or puree pieces.** Fill hot jars, leaving 1-inch headspace. Add 1 teaspoon salt per quart to the jar, if desired. Cover with your choice of fresh boiling water or syrup, leaving 1-inch headspace. Adjust lids and process.

Process time for Sweet Potatoes			Weight Setting at Altitudes of	
Style of Pack	Jar Size	Process Time	0-1,000 ft	Above 1,000 ft
Hot	Pints	65 min	10 lb	15 lb
	Quarts	90 min	10 lb	15 lb

POTATOES, WHITE – CUBED OR WHOLE

An average of 5 pounds is needed per quart. Select small to medium-size mature potatoes of ideal quality for cooking. Tubers stored below 45° F may discolor when canned. Choose potatoes 1 to 2 inches in diameter if they are to be packed whole. Wash and peel potatoes. Place in ascorbic acid solution to prevent darkening use (3 grams per 1 gallon of cold water). If desired, cut into ½ -inch cubes. Drain. Cook 2 minutes in boiling water and drain again. For whole potatoes, boil 10 minutes and drain, Add 1 teaspoon of salt per quart to the jar, if desired. Fill hot jars with hot potatoes and fresh hot water, leaving 1-inch headspace. Adjust lids and process.

Process time for White Potatoes			Weight Setting at Altitudes of	
Style of Pack	Jar Size	Process Time	0-1,000 ft	Above 1,000 ft
Hot	Pints	35 min	10 lb	15 lb
	Quarts	40 min	10 lb	15 lb

PUMPKINS AND WINTER SQUASH – CUBED

An average of 2¼ pounds is needed per quart. Pumpkins and squash should have a hard rind and stringless, mature pulp of ideal quality for cooking fresh. Small size pumpkins (sugar or pie varieties) make better products. Wash, remove seeds, cut into 1-inch wide slices, and peel. Cut flesh into cubes. Boil 2 minutes in water. **Caution: Do not mash or puree.** Fill hot jars with cubes and cooking liquid, leaving 1-inch headspace. Adjust lids and process. For making pies, drain jars and strain or sieve cubes.

Process time for Pumpkin and Winter Squash			Weight Setting at Altitudes of	
Style of Pack	Jar Size	Process Time	0-1,000 ft	Above 1,000 ft
Hot	Pints	55 min	10 lb	15 lb
	Quarts	90 min	10 lb	15 lb

SOUPS (Vegetable, dried bean or pea, meat, poultry, or seafood)

Select, wash, and prepare vegetables, meat, and seafood as described for the specific foods. Cover meat with water and cook until tender. Cool meat and remove bones. Cook vegetables. For each cup of dried beans or peas, add 3 cups of water, boil 2 minutes, remove from heat, soak 1 hour, and heat to boil. Drain and combine with meat broth, tomatoes, or water to cover. Boil 5 minutes. **Caution: Do not thicken.** Salt to taste, if desired. Fill hot jars halfway with solid mixture. Add remaining liquid, leaving 1-inch headspace. Adjust lids and process.

Process time for Soups			Weight Setting at Altitudes of	
Style of Pack	Jar Size	Process Time	0-1,000 ft	Above 1,000 ft
Hot	Pints	60* min	10 lb	15 lb
	Quarts	75* min	10 lb	15 lb

***Caution: Process 100 minutes if soup contains seafood.**

SPINACH AND OTHER GREENS

An average of 4 pounds is needed per quart. Can only freshly harvested greens. Discard any wilted, discolored, diseased, or insect-damaged leaves. Leaves should be tender and attractive in color. Wash only small amounts of greens at one time. Drain water and continue rinsing until water is clear and free of grit. Cut out tough stems and midribs. Place 1 pound of greens at a time in cheesecloth bag or blancher basket and steam 3 to 5 minutes or until well wilted. Add ½ teaspoon of salt to each quart jar, if desired. Fill hot jars loosely with greens and add fresh boiling water, leaving 1-inch headspace. Adjust lids and process.

Process time for Spinach and Other Greens			Weight Setting at Altitudes of	
Style of Pack	Jar Size	Process Time	0-1,000 ft	Above 1,000 ft
Hot	Pints	70 min	10 lb	15 lb
	Quarts	90 min	10 lb	15 lb

SUCCOTASH

15 lbs unhusked sweet corn or 3 qts cut whole kernels

14 lbs mature green podded lima beans or 4 qts shelled lima beans

2 qts crushed or whole tomatoes (optional)

Yield: 7 quarts

Hot Pack – Combine all prepared vegetables in a large kettle with enough water to cover the pieces. Add 1 teaspoon salt to each quart jar, if desired. Boil gently 5 minutes and fill hot jars with pieces and cooking liquid, leaving 1-inch headspace. Adjust lids and process.

Raw Pack – Fill hot jars with equal parts of all prepared vegetables, leaving 1-inch headspace. Do not shake or press down pieces. Add 1 teaspoon salt to each quart jar, if desired. Add fresh boiling water, leaving 1-inch headspace. Adjust lids and process.

Process time for Succotash			Weight Setting at Altitudes of	
Style of Pack	Jar Size	Process Time	0-1,000 ft	Above 1,000 ft
Hot and Raw	Pints	60 min	10 lb	15 lb
	Quarts	85 min	10 lb	15 lb

QUESTIONS AND ANSWERS ON HOME CANNING

Q. Why is the cooking liquid used for packing some vegetables and boiling water for others?

A. Cooking liquid is recommended for packing most vegetables because it may contain minerals and vitamins dissolved out of the food. Boiling water is recommended when cooking liquid is dark, gritty, or strong-flavored, and it may be used if there isn't enough cooking liquid.

Processing time is the same whether hot cooking liquid or boiling water is used for packing.

Q. Why is liquid sometimes lost from glass jars during processing?

A. Loss of liquid may be due to a number of things:

- 1) Cooking food too short a time to drive out the air that is in it before packing it in the jars.
- 2) Packing jars too full.
- 3) Leaving air bubbles in the jars.
- 4) Not keeping pressure steady in a pressure canner.
- 5) Lowering pressure too suddenly at the end of the processing period.
- 6) Food is packed to tightly.
- 7) Food is processed at too high a temperature.
- 8) Leakage of steam between lid and bottom of pressure cooker.

Q. Should liquid lost during processing be replaced?

A. No, never open a jar and refill with liquid – this would let in bacteria, and you'd need to process again. Loss of liquid does not cause food to spoil, although the food above the liquid may darken.

Q. What causes cloudy liquid in canned fruits and vegetables?

A. Cloudy liquid may be a sign of spoilage. It may also be caused by the minerals in hard water or by starch from overripe vegetables.

Q. How can you tell whether food with cloudy liquid is spoiled?

A. Boil the food and note the odor. Do not taste or use any food having an off odor.

Q. Why does canned fruit sometimes float in jars?

A. Fruit may float because the pack is too loose or the syrup too heavy. It's also possible that air in the tissues of the fruit has not all been forced out during heating and processing.

Q. Why does my food turn moldy after processing?

A. Mold can only form in the presence of air. Therefore, jars are not sealed if mold is present.

Q. What makes canned foods change color?

A. Darkening of foods at the tops of jars may be caused by oxidation due to air in the jars or by too little heating or processing to destroy enzymes. Over-processing may cause discoloration of foods throughout the containers.

Pink and blue colors sometimes seen in canned pears, apples and peaches are caused by chemical changes in the coloring matter of the fruit.

Iron and copper from utensils used in preparing foods, or from the water in some localities, may cause brown, black and gray colors in some foods. Corn turns brown during processing when too high a temperature is used. The high temperature causes a caramelization of the sugar in corn. It may also be caused by some chemical, such as iron, in the water used in canning.

When canned corn turns brown, the discoloring may be due to the variety of corn, the state of ripeness, or over-processing. A common cause of highly colored foods fading is the dissolving of coloring materials by the packing liquid. The use of plain tin cans will cause some foods to lose color.

Q. Is it safe to eat discolored canned foods??

A. The color changes noted above do not mean the food is unsafe to eat. However, spoilage may also cause color changes. Any canned food that has an unusual color should be examined carefully before use.

Q. Why does the underside of metal lids sometimes discolor?

A. Natural compounds in some foods corrode the metal and make a brown or black deposit on the underside of the lid. This deposit is harmless and doesn't mean that the food in the jar is unsafe to eat.

Q. Why do jars not seal properly?

A. Jars that do not seal may be due to a number of things:

- 1) Incomplete sterilization; failure to follow exact timetables and recipes.
- 2) Failure to wipe sealing edge of jar clean before placing lid on jar.
- 3) Food, seeds or grease lodged between lid and jar.
- 4) Clamps not properly adjusted on lightening or bail-type jars.
- 5) Jars which are nicked or cracked or have sharp sealing edges.
- 6) Band screwed down too loosely before processing on Mason jar and two-piece metal lid.
- 7) Turning jars upside down while jars are cooling and sealing.

Q. When canned or frozen fruits are bought in large containers, is it possible to can them in smaller containers?

A. Any canned or frozen fruit may be heated through, packed, and processed the same length of time as recommended for freshly prepared food. This canned food may be of lower quality than if it had been canned when fresh.

Q. Is it safe to leave food in tin cans after opening?

A. Yes, but like fresh cooked food, food in tin cans needs to be covered and kept in a refrigerator or other cold place.

Q. When processing food, is it necessary to have the pressure cooker filled with jars?

A. It is economical to process at one time as many jars as the cooker will hold, for it saves time and fuel. But if you do not have enough jars to fill the cooker, a smaller number may be successfully processed.

Q. Is it possible to process two layers of jars in cooker at one time?

A. Yes, providing the model you have has sufficient room for two layers of jars. Use the rack between layers of jars.

Q. What causes the lids to buckle?

A. Buckling lids may be due to a number of things:

- 1) This problem may be caused by tightening the jar rings too tightly before processing the jars. During processing, the flexible metal lid permits the jar to exhaust air, and rings that are too tight will not allow the air to escape during processing.
- 2) Not following the correct preheating process for the brand of lids used.
- 3) Filling the jars too full.
- 4) Using the raw-pack method for starchy vegetables.
- 5) A steam leak from the pressure canner lid.
- 6) Cooling the pressure canner with water or cool air.
- 7) Using a jar with a mouth that is too large for the lid (such as a mayonnaise jar).

Q. What causes the jars to break?

A. Breakage of jars may be due to a number of things:

- 1) Jars are too tight in pressure cooker.
- 2) Not using standard jars.
- 3) Jars improperly tightened.
- 4) Not placing jars on rack (jars touching the bottom of canner).
- 5) Over filling jars or packed too solidly.
- 6) Sudden temperature change between jars and water in unit.
- 7) Jars have invisible hairline cracks.
- 8) Fluctuation of pressure during processing; be sure to maintain a steady pressure.

Q. If a jar does not seal and must be reprocessed, does it have to be processed the full length of time?

A. Just what should be done with the unsealed jar will depend upon the cause. If the cap or lid is at fault and the product is a fruit, simply replace the cap or lid with new one and process until product reaches boiling point. If it is a vegetable or meat, it should be reprocessed approximately one-fourth to one-third the regular processing period. If the jar is defective, any product would require repacking. It is doubtful if this will be profitable since the reprocessing would need to be of approximately the same length as a normal period for that particular food. Few foods will stand up under such treatment.

BASIC COOKING INSTRUCTIONS

Check Metal-to-Metal Seal for Lubrication and check to make sure vent pipe is clear. (See page 10)

Place Food and Water Inside

Place 2 to 3 inches of water (or the amount called for in the recipe or canning instructions) in bottom of cooker. Always place a rack in bottom of the pressure cooker with the rim facing down when using pans, canning jars, or tin cans. Never allow these containers to stand directly on the bottom of the cooker. The rack is also useful for holding meat or vegetables out of the water while cooking.

Place Cover On Cooker

Place cover on cooker bottom so that arrow on cover aligns with the notch mark on the bottom. Gradually and evenly tighten two opposite wing nuts at the same time, maintaining the same size gap around the entire unit where the cover meets the bottom. **Never tighten just one wing nut at a time.** (See page 9)

Using Cooker

1. Set the pressure regulator weight over vent pipe, aligning the weight so that the hole corresponding to the desired pressure is directly over the vent pipe.
2. Place pressure cooker over heat source, and when the pressure regulator weight begins to jiggle and sputter, adjust the heat until it jiggles only one to four times each minute. The pressure regulator weight will jiggle or rock when the pressure is reached. **NEVER TURN UP THE HEAT TO THE POINT THAT A CONSTANT FLOW OF STEAM IS ESCAPING, THEREBY CAUSING THE PRESSURE REGULATOR WEIGHT TO BE CONSTANTLY IN THE "UP" POSITION. REDUCE THE HEAT SO THAT THE PRESSURE REGULATOR WEIGHT ONLY JIGGLES AND SPUTTERS FROM ONE TO FOUR TIMES A MINUTE.**

Experience with the pressure regulator weight will teach you what setting on your stove will maintain the proper pressure and how long it takes to bring the pressure cooker to the point where the pressure regulator weight jiggles or rocks. This will depend on which size pressure cooker you have and how much food you are cooking.

The pressure regulator weight lets you select one of three pressure settings.

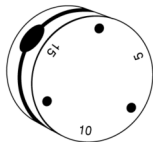

Pressure	Cooking Temperature	
5 lbs.	228° F	109.0°C
10 lbs.	240° F	115.5°C
15 lbs.	250° F	121.0°C

When the pressure cooker reaches the proper temperature, the pressure regulator weight will jiggle audibly, and you can see the steam being released. The pressure will be automatically maintained for proper pressure cooking. The pressure regulator weight itself never requires adjustment or testing for accuracy.

Please understand that there will not be an exact correlation between the pressure shown on the gauge to the corresponding pressure setting on the pressure regulator weight. For example, even though you have set the pressure regulator weight at 10 lbs., the gauge may show a range during the cooking process of 8 to 12 lbs. Do not expect the gauge to always show the exact pressure setting as the pressure regulator weight, as the pressure is changing within the unit as the pressure regulator weight jiggles and sputters, which is simply a process of constantly building up and releasing pressure to maintain the setting on the pressure regulator weight.

Even in the situation where the gauge is not registering correctly for any reason, you can be assured that the unit will still operate at the pressure regulator weight setting. The basic reason that our pressure cooker retains the gauge is to provide additional information as to the pressure and temperature within the unit, but you can be assured that the unit is functioning at the pressure regulator weight setting.

Try to keep the pressure as steady as possible by regulating the amount of heat applied to the cooker. ***At no time should the pressure be allowed to rise above 15 P.S.I.*** Excess pressure should be decreased by turning heat down. *Remember, it is the amount of heat applied to the unit that regulates the pressure.*

3. To count your cooking time, begin from the first jiggle or rock of the pressure regulator weight, and when the food has cooked to proper pressure for the correct period of time, turn off the heat.

Reduce Pressure

WARNING: Steam escaping from the vent pipe can scald or burn you and the pressure regulator weight may be hot. Protect your hand with a pot holder or mitt.

When cooking is completed and heat is off, reduce pressure as follows:

- After most normal cooking, permit cooker to cool until steam pressure gauge reads zero.
- After cooking soup, cereals, or any food that might boil over in the pans, turn heat off and permit cooker to cool.

Do not put cold cloths or water on the cooker to hasten cooling. This may crack the aluminum.

Do not move the pressure cooker until the pressure is completely reduced.

Opening Cooker Safely

CAUTION: Never loosen wing nuts until the steam pressure gauge registers zero, and you have allowed any remaining pressure to escape by carefully removing the selective pressure regulator weight.

Remove cover, *raising farthest edge first to protect face and arms from steam.*

When the pressure regulator weight is left on, a vacuum may form inside the cooker making the cover difficult to remove. To avoid a vacuum, which will cause the cover to be drawn to the bottom very tightly, you must remove the pressure regulator weight from the vent pipe as soon as the pressure gauge indicator reaches zero P.S.I. and then remove the cover. The longer you wait without removing the pressure regulator weight, the more vacuum will form, pulling the cover tighter and tighter to the bottom.

Another reason that a cover sticks to the bottom is that the metal-to-metal seal has been permitted to build up a coating of foreign material such as dried grease, lubricating oil, etc. Please refer to page 10 under the section "Metal-to-Metal Seal, Cleaning and Maintenance" for complete instructions.

COOKING IN THE PRESSURE COOKER

Meat

When cooking meats, place empty cooker on stove to heat. Put fat in bottom of cooker and sear meat on all sides to seal in juices. Add ½-inch water to bottom of cooker (or the amount called for in the recipe), and cook for time given in timetable or recipe. Follow instructions under Basic Cooking Instructions, page 47.

The length of cooking period for meats depends on the amount and distribution of the fat on the meat, the amount of bone, toughness, size, thickness of cut, and the position of the meat in the cooker. Rolled roasts require a longer cooking time per pound than unboned roasts, and short, chunky roasts require longer cooking time than long, flat ones. Due to the difference in surface area of small roasts up to 3 or 4 pounds, they require a longer cooking time per pound than larger roasts. Consequently, it is possible to give only general rules regarding average cooking time for meats. Average times are about 8 to 10 minutes per pound for rare, and at least 12 to 15 minutes per pound for well done. With a little experimenting, you will be able to regulate the cooking time according to a particular cut of meat.

MEAT TIMETABLE

	Cook At 15 Pounds Pressure
Beef	
Rump or chuck roast.....	12 to 15 min. per lb.
Corned beef.....	12 to 15 min. per lb.
Ground meat loaf.....	8 to 10 min. per lb.
Pot roast, thin.....	8 to 10 min. per lb.
Pot roast, thick.....	10 to 12 min. per lb.
Fresh tongue.....	35 to 45 min.
Tongue, smoked or cured.....	60 min.
Round steak, 1" thick.....	15 min.
Stew meat cubes.....	15 to 20 min.
Hearts.....	15 to 20 min.
Lamb or Mutton	
Shoulder roasts.....	10 to 12 min. per lb.
Stew cubes.....	15 min.
Pork	
Fresh ham.....	12 to 15 min. per lb.
Loin roasts.....	10 to 12 min. per lb.
Shoulder roasts.....	12 to 15 min. per lb.
Pork chops, 1" thick.....	10 min.
Pork steak, 1" thick.....	10 min.
Pork shanks.....	20 to 30 min.
Spareribs	
Spareribs.....	15 min.

Vegetables

Prepare vegetables in the usual manner and season. Pour about ½ -inch of water in the bottom of the cooker. Place vegetables on rack or in a metal pan resting on the rack.

For best color and texture, when done cooking, turn the heat off, allow pressure to reach zero, remove the regulator weight, then remove the cover, raising the farthest edge first to protect face and arms from steam. Do not allow the vegetables to remain in the cooker once the pressure is down to zero.

VEGETABLE TIME TABLE

Vegetable	Preparation	COOKING TIME (Minutes) At 15 Pounds Pressure
Asparagus	Clean and wash. Use pan	1-3
Beans, green or wax	Wash and cut	2-3
Beets	Wash, leaving root and 2" of stem on. Cook. Peel and dice. Season with salt, butter, pepper and a little vinegar and sugar	New 12-18; Old 15-20
Brussels Sprouts	Wash	2
Cabbage	Quarter and season with salt	8
Carrots	Slice, put in pan. Season	Sliced 2; Whole 3-4
Cauliflower	Soak head ½ hour in cold salt water. Divide sections. Place in Pan ..	1-2
Celery	Wash and dice	2-3
Corn-on-the-cob	Clean and place on rack	3-5
Hominy	30
Onions	Place in pan. Season	Sliced 3; Whole 10
Parsnips	Wash. Cook on rack	Sliced 3; Whole 10
Peas	Shell and wash	2-3
Potatoes, Irish	Peel and place in pan	10-20
Potatoes, scalloped	10
Potatoes, sweet	Wash, peel, quarter or halve, cook on rack	8-10
Pumpkin or Winter Squash	Wash and remove seeds. Break in pieces and place in pan	10-12
Rutabagas	Peel and wash	Sliced 5; Quartered 12
Spinach, Swiss Chard	Wash thoroughly in several waters	2
Turnips	Slice or dice. Use pan. Season with salt and a little sugar	4-5

PRESSURE COOKING DRY BEANS AND PEAS

The pressure canner is ideal for preparing dry beans and peas quickly. However, dry beans and peas have a tendency to froth and foam during cooking, which could cause the vent pipe to become blocked. **Therefore, it is necessary to use the following cautions when pressure cooking dry beans and peas:**

- 1) Never fill the canner over ½ full (this includes beans, ingredients and water)
- 2) Add 1 tablespoon vegetable oil for cooking
- 3) Allow pressure to drop of its own accord

Soaking Beans and Peas

Soaking is strongly recommended for all beans and peas, except lentils and black-eyed peas, for even cooking and to remove water-soluble, gas-producing starches. Soaking can be done using the traditional or the quick-soak method.

Traditional Method

Clean and rinse beans; cover with three times as much water as beans. Soak 4 to 8 hours. Drain.

Quick Method

Clean and rinse beans; cover with three times as much water as beans. Bring beans to a boil and boil 2 minutes. Remove from heat, cover and let stand for 1 to 2 hours. Drain.

Cooking Beans and Peas

After soaking, rinse beans and remove any loose skins. Place beans in pressure canner. Add fresh water to just cover the beans and add 1 tablespoon vegetable oil. Close cover securely. Place pressure regulator weight on the vent pipe at the 15lb. setting and cook according to the times in the timetable below. For more firm beans for salads and side dishes and when cooking less than 2 cups of beans or peas, use the shorter time. For soups and stews, use the longer time. **After cooking is complete, allow pressure to drop of its own accord.**

DRY BEANS AND PEAS TIMETABLE

Soak beans and peas, except lentils and black-eyed peas, according to information above. **Add 1 tablespoonful vegetable oil to cooking liquid. DO NOT COOK SPLIT PEAS.**

FOR DRY BEANS AND PEAS, DO NOT FILL CANNER OVER ½ FULL!

BEANS AND PEAS	COOKING TIME MINUTES
Adzuki	1-3
Anasazi	1-3
Black Beans	2-4
Black-eyed Peas.....	2-4 *
+Chickpeas (garbanzo)	7-10
Great Northern Beans	2-5
Kidney Beans	1-3
Lentils (brown, green)	3-5 *
+Lima Beans (large).....	0-1
+Lima Beans (baby).....	1-3
Navy Beans (pea).....	1-3
Peas (whole yellow, green).....	6-9
Pinto Beans	3-6
Red Beans	3-6
Soy Beans (beige).....	8-11

*Cooking time is for unsoaked beans

+Add ½ to 1 teaspoon salt to soaking and cooking water to keep bean skins intact

TABLES AND CHARTS

NUMBER OF CANS PER BUSHEL

	WEIGHT PER BUSHEL	NO. 2 CANS (PINTS)	NO. 3 CANS (QUARTS)
1 bushel of Windfall apples	50 lbs.....	30	20
Cranberries	33 lbs.....	—	—
Standard peaches.....	48 lbs.....	25	18
Pears.....	50 lbs.....	45	30
Plums.....	60 lbs.....	45	30
Blackberries.....	—	50	30
Windfall oranges (whole)	50 lbs.....	35	22
Tomatoes	56 lbs.....	22	15
Shelled lima beans.....	—	50	30
String beans.....	24 lbs.....	30	20
Sweet corn	—	16	—
Shelled peas.....	—	45	25
Sweet potatoes.....	50 lbs.....	30	20

STEAM PRESSURE OBTAINED IN PRESSURE CANNERS AND CORRESPONDING DEGREES OF TEMPERATURE

POUNDS OF PRESSURE	DEGREES FAHRENHEIT	DEGREES CENTIGRADE
3	220	104.5
5	228	109.0
10	240	115.5
15	250	121.0
20	259	126.0
25	267	130.5

BOILING POINT OF WATER AT DIFFERENT ALTITUDES ABOVE SEA LEVEL

ALTITUDE FEET	BOILING POINT FAHRENHEIT	BOILING POINT CENTIGRADE
1,025	210	99.0
2,063	208	98.0
3,115	206	97.0
4,169	204	96.0
5,225	202	94.4
6,304	200	93.0
7,381	197	92.0
8,481	196	91.0
9,031	195	90.5

Show Weights On Labels

Suggested weight of contents to be used on labels to comply with the various state and national pure food laws. The following weights allow for reasonable tolerance. Cans which are reasonably well-filled will weigh more than weights expressed.

FRUITS

	SIZE CAN	LBS.	OZS.
Apples	2	1	2
	3	1	14
Blackberries	2	1	3
	3	2	1
Grapefruit	2	1	4
	2½	1	13
Peaches	2	1	3
	3	2	1
Pears	2	1	3
	3	2	1

VEGETABLES

	SIZE CAN	LBS.	OZS.
Asparagus	2	1	3
Beans, String	2	1	3
Beets	2	1	4
Corn	2	1	4
Peas	2	1	4
Tomatoes	3	2	1
	2	1	3

ALL-AMERICAN PRESSURE COOKER/CANNER PARTS LIST

EFFECTIVE SEPTEMBER 1, 2014

ORDER BY PART NUMBER AND DESCRIPTION

PART NO. DESCRIPTION

	Bottom only (Specify size; not shown)
	Cover only (Specify size; not shown)
54	Clamp Bolt (630000)
55	Pin for Clamp Bolt (630010)
64	Phenolic Wing Nut (630020)
65	Control Valve (No longer available – Replaced by Part Nos. 68 and 69)
68	Pressure Regulator Weight (Z000122)
69	Vent Pipe for Pressure Regulator Weight (Z000131)
72	Geared Steam Gauge, includes lens, fits all sizes (Z000127)
73	Lens for Steam Gauge, replacement, not shown (670050)
74	Instruction and Recipe Book (610500)
75	Cleaning Rod for Vent Pipe (650060)
76	Bakelite Top Handle (No longer available – Replaced by Part No. 76-09RM)
76-09 RM	Replacement for item number 76, old style bakelite top handle; includes screws
76-09	New Style Phenolic Top Handle; includes screws (see picture next page)(Z000187)
77-09	Screw for 76-09 Phenolic Top Handle (630077)
78	Retaining Bayonet Clamp (630090)
79	Retaining Bayonet Clamp Screw (670020)
111	Rack (9½" diameter) for No. 910 Cooker (630110)
151	Rack (11½" diameter) for Nos. 915, 921, 925, and 930 Cookers (630120)
184	Cross Bar Set for use with pudding pan for Nos. 915, 921, 925 and 930 Cookers (630360)
253	Pudding Pan for Nos. 915, 921, 925 and 930 Cookers (630370)
405	Side Handle, complete, for Nos. 930 and 941 (630230)
2040	Overpressure Plug for Pressure Cookers, black (Z000124)
2072	Wire Canning Rack fits No. 941 Cooker only, dia. 12¾", not shown (630150)
313 DVD	"At Home Canning", 1 hour 49 minutes
814 DVD	"Basic Operating Instructions", 10 ½ minutes

NOTE: • Model No. 915 Pressure Cooker was formerly called Model No. 7
• Canning baskets are no longer available.
• The Cross Bar Set is only used when stacking pudding pans.
• Parts will fit all sizes unless specified.

If you would like to order parts please telephone or email Wisconsin Aluminum Foundry.

WISCONSIN ALUMINUM FOUNDRY

Consumer Products Division • 1931 South 14th Street • P.O. Box 246 • Manitowoc, Wisconsin 54221-0246
TEL: 920-682-8627 • FAX: 920-682-4090 • email: customerrelations@wafco.com • web: www.allamerican-chefsdesign.com

PARTS ILLUSTRATIONS (Not to Scale)



54



55



64



68



69



72

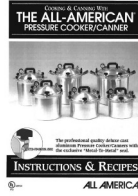

74



75



76 – No Longer Available
If you require a replacement for #76, then order #76-09 RM



76-09 RM w/screws
(Replacement for #76)



76-09 w/screws



77-09



78



79



111 & 151



184



253



405



2040

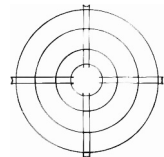

2072

INDEX

Acid Foods.....	13, 15	Directions, Use of Cooker.....	9	Poultry Canning.....	31
Altitude Tables.....	49	Duck.....	31	Pressure Regulator Weight...20	
Apples.....	22	Exhausting.....	18	Pumpkin.....	41
Applesauce.....	22	Filling Cooker.....	11	Putting Cover ON.....	9, 45
Apricots.....	23	Fish, canning.....	34-35	Questions and Answers...43-44	
Asparagus.....	36	Fowl, canning.....	31	Rabbit.....	31
Beans.....	36-37	Fowl, cooking.....	31	Raw-Pack.....	16
Beef.....	32-33	Fruits, canning.....	22-25	Reducing Pressure.....	21, 46
Beef, roast.....	32	Fruit Juices.....	24-26	Rhubarb.....	25
Beets.....	38	Gauge, Steam Pressure.....	6	Safety Tips For Canning.....	14
Berries.....	23	Grapefruit/Orange.....	24	Safety Tips For Operating inside front cover.....	14
Black-eyed Peas.....	1, 48	Greens.....	41	Seafood Canning.....	31
Black Bean Soup.....	41	Half-gallon jars.....	16	Seafood Cooking.....	33-35
Blanch.....	40	Half-pint jars.....	16	Sealing Cans and Jars.....	17-18
Botulism.....	15	Headspace.....	13	Soups.....	41
Brine.....	32	Hot Fill or Hot-Pack.....	13, 16	Spaghetti Sauces.....	29-30
Broth.....	32	Hot Water Bath.....	13	Spareribs.....	47
Bushel, Cans per.....	49	Jars.....	17	Spinach.....	41
Canning Instructions.....	20	Lamb.....	47	Spoilage.....	14-15
Canning Recipes.....	22-42	Lemon Juice.....	13	Squash.....	11
Canning Tables.....	49	Lima Beans.....	37	Steps in Canning.....	18-20
Canning Terms.....	13	Lids.....	17-18	Steam Pressure Gauge.....	6, 11
Cans.....	18-19	Meat, canning.....	31	Storing.....	16
Can Sealers.....	54	Meat, cooking.....	47	Stuck Cover, removing.....	21
Canning Problems.....	19-22	Metal-to-Metal Seal.....	9-10	Succotash.....	42
Care of Cooker.....	10	Nectarines.....	24	Syrup.....	22
Carrots.....	38	Opening Cooker.....	46	Tables and Charts.....	49
Cherries.....	23	Okra.....	39	Thermometer.....	16
Chicken.....	31	Overpressure Plug.....	7, 12	Tomato Juice.....	26
Chili Con Carne.....	33	Parts Diagrams.....	8	Tomatoes.....	27-28
Citric Acid.....	26	Parts List.....	6, 7, 51 & 52	Vegetables, canning.....	36-42
Clams.....	33	Peaches.....	24	Vegetables, cooking.....	47
Cooking Recipes.....	22-42	Pears.....	25	Vegetable Soup.....	41
Cooking Resources.....	5	Peas, green.....	1, 39, 48	Vent Pipe.....	10
Cooking Instructions.....	45-47	Peppers.....	40	Water Pack.....	16
Cooking Tables.....	49	Plums, Prunes.....	25	Winter Squash.....	41
Cooling.....	19	Pork.....	47	DVD's.....	5, 51
Corn.....	38-39	Potatoes.....	40		
Crab Meat.....	34				

ALL AMERICAN AUTOMATIC CAN SEALERS

AMERICA'S LEADING QUALITY AUTOMATIC CAN SEALER. A SIZE FOR EVERY NEED.

ALL AMERICAN Can Sealers are designed for use by Commercial Cannerys, Custom Cannerys, Laboratories, Gift Packaging Centers, Breweries and Home Cannerys.

Prices on equipment for sealing the 202, 208, 300, 211 (No.1), 307 (No.2), 401 (No.2 1/2), 404 (no.3) and 502 (No.5) are available upon request. Our sealers can handle a variety of can sizes. If you are uncertain of the exact size of a particular can or if your can has a **pull-ring/pull-tab** or if it is a composite can, we will require at least six sample cans and lids in order to determine if one of our can sealers will seal your sample can. Please send sample cans, along with a cover letter, to the address below.

The Master Can Sealer frame is made of die cast aluminum. Perfectly cast and accurately machined, it's built for a lifetime of service.

The Master Can Sealer is simple and easy to operate. It's easily adjusted for different sizes of cans, making it economical to own and operate.

ALL MODELS SUITABLE FOR COMMERCIAL AND SEMI-COMMERCIAL USE



Model 225

Automatic Master Can Sealer

Equipped to Seal No.2 or No. 3 Cans

Shipping Info: 14" x 11" x 11" Wgt: 13 lbs



Model 225F

Automatic Fly-Wheel Can Sealer

Equipped to Seal No.2 or No. 3 Cans

Shipping Info: 16" x 15" x 14" Wgt: 22 lbs

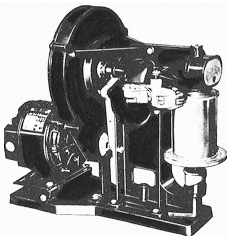

Model EL-12253-110V

Automatic Portable Electric Sealer

Equipped to Seal No.2 or No. 3 Cans

Shipping Info: 23" x 13" x 19" Wgt: 42 lbs

The Electric Can Sealer will seal approximately 150 cans per hour. The low mounted motor eliminates vibration. Pulley guard included.



Senior Automatic Sealers

Model 1502 Equipped to Seal Nos. 10 & 12 Cans

Shipping Info: 15" x 15" x 21" Wgt: 26 lbs

Model 7502 Equipped to Seal Nos. 2 or 3 Cans and 10 & 12 Cans

Shipping Info: 15" x 15" x 21" Wgt: 28 lbs

MANUFACTURED IN THE U.S.A. BY WISCONSIN ALUMINUM FOUNDRY CO., INC.

1931 SOUTH 14TH ST., P.O. BOX 246, MANITOWOC, WISCONSIN 54221-0246

TEL: (920) 682-8627 / FAX: (920) 682-4090

email: customerrelations@wafco.com website: allamerican-chefsdesign.com

CHEF'S DESIGN®

Wisconsin Aluminum Foundry also manufactures Chef'sDesign, fine quality cast aluminum cookware. This professional weight cookware ensures superb heat absorption and conduction. Food cooks evenly and at lower temperatures. Each piece is coated with satiny-smooth non-stick finish, making clean-up fast and easy. Chef'sDesign Cookware is the ultimate in quality, design and convenience. Add the crisp, clean, contemporary styling of Chef'sDesign Cookware to your kitchen today.

Ribbed Rangetop Griddle



This ribbed griddle turns ordinary rangetops into an indoor grill. Grills meat, poultry, seafood and vegetables. A deep groove around the edge of the pan drains away excess fats and oils for healthier cooking.

Model 3540
Dimensions 10³/₈" x 18⁷/₈"

The Ultimate Griddle

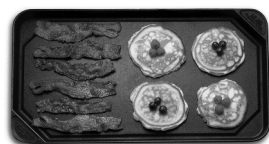

A huge griddle. Turns all rangetops into the ultimate non-stick griddle, perfect for eggs, bacon, sandwiches, pancakes, vegetables and meats. Grooved edge drains fats and oils, which collect in large corner wells—

not in your food.
Model 6050
Dimensions 11" x 19¹/₂"

Side-By-Side Griddle

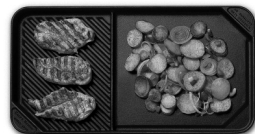

Combine a ribbed grilling surface with a flat griddle, and you have a complete meal, preparation center. The world's finest non-stick surface assures easy clean-up.

Model 6040
Dimensions 10³/₄" x 20"

Lasagna Pan Plus



If you only had one pan for baking, this would be it. This deep-dish pan offers true versatility. It's perfect for everything from lasagna and casseroles to roasts and hams.

Model 6260
Dimensions 10" x 12" x 3"

Gourmet Specialty Pan & Buffet Server



This elegant Gourmet Specialty Pan is a buffet serving tray and also a superior griddle. A large 12" griddle surface is perfect for sautéing, searing and browning.

Model 2360
Dimensions 12" x 8" x 6"

Cast Aluminum Covered Roasters



Heavy cast aluminum roaster and cover with eye-catching highly polished exterior. Premium non-stick interior. Flat roasting rack included.

3 sizes available:
13¹/₂", 16¹/₂" and 18"

Heavy Aluminum French Roasters



Heavy aluminum roasters with unique stainless steel rack. Based on a traditional French design these roasters are a modern update with high sides, triple riveted handles that are the right size for oven mitts and non-stick interior. Polished exteriors suitable for serving.

3 sizes available:
14¹/₂", 16¹/₂" and 18"

In addition to non-stick cookware, Chef's Design also offers these other premium kitchen products:

Stainless Steel Pressure Cookers



Chef'sDesign Stainless Steel Pressure Cookers are premium models crafted of the finest 18/10 stainless steel for durability, safety and ease of cleaning. The bottoms are made with an aluminum/steel "sandwich" for superior heat conductivity.

Finished with an attractive mirror-like finish, these pressure cookers work equally well on gas, traditional electric, ceramic electric and induction stove tops. Chef'sDesign Pressure Cookers also include a tempered glass cover that converts the cooker to a traditional sauce pan. Ten year limited warranty.

Models D4.5, D6, D8, D10
4.5 Liter, 6 Liter, 8.5 Liter, 10.3 Liter Sizes

The Essential 3-Piece Cookware Set



This high-quality 3-piece Gourmet Griddle, Grill Pan and Grill Press set features a large 12"x12" cooking area coated with ETERNA® the world's longest-lasting nonstick for fast and easy cleanup. Suitable for all heat sources: induction, gas, electric, ceramic and halogen.

Model 2123
Dimensions 12" x 12"

If you are unable to locate these fine products in your local stores, please contact our factory for further information.

WISCONSIN ALUMINUM FOUNDRY CO., INC.

Consumer Products Division
P.O. BOX 246
MANITOWOC, WISCONSIN 54221-0246
TEL: (920) 682-8627 / FAX: (920) 682-4090
email: customerrelations@wafco.com website: allamerican-chefsdesign.com