

INSTALLATION and USER'S MANUAL

GaLiO Fire Pit Corten

Natural Gas/Propane-Butane/Propane

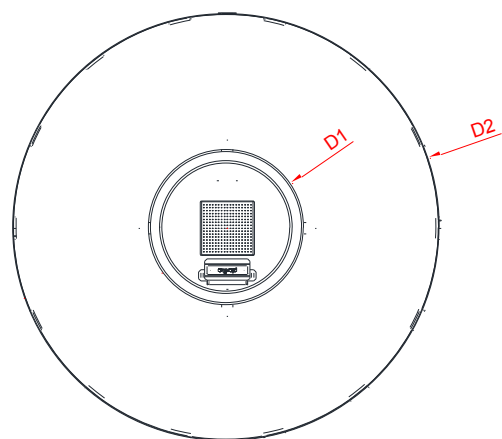
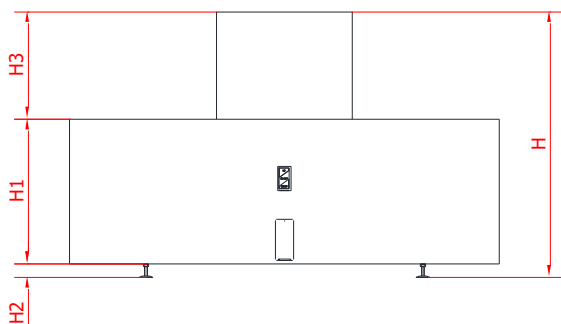

	H	H1	H2	H3	D1	D2
[mm]	650	320	30	300	350	950

IT IS OBLIGATORY TO READ AND KEEP THIS INSTRUCTION MANUAL.

TABLE OF CONTENTS

1.	INTRODUCTION	3
2.	SAFETY INSTRUCTIONS.....	5
2.1	Safety instruction regarding the use of the gas cylinders.	6
3.	INSTALLATION	7
3.1.	Box contents.....	7
3.2.	Unboxing and installation	7
4.	MONTAGE	8
4.1.	Installation of glass screens.....	10
4.2.	Installation of the gas linkage.....	10
4.2.1.	Natural gas connection.....	10
4.2.2.	Connection and replacement of the gas cylinder (LPG version).....	11
5.	OPERATING INSTRUCTIONS	11
5.1.	General Notes	11
5.2.	Setting up signal code	11
5.3.	Replacing the batteries	12
5.4.	Remote control (if delivered)	13
5.4.1.	Setting fahrenheit or celsius.....	14
5.4.2.	Setting the time	14
5.4.3.	Child proof.....	14
5.4.4.	Switch the Fire ON and OFF.....	15
5.4.5.	Stand-by mode (Pilot flame).....	16
5.4.6.	Flame height adjustment.....	16
5.4.7.	Flame height directly to minimum position	16
5.4.8.	Flame height directly to maximum position.....	16
5.4.9.	Countdown timer	17
5.4.10.	Automatic Turn Down To Pilot	17
5.4.11.	Automatic Shut Off.....	17
5.5.	Touchpad.....	18
6.	TESTING.....	18
6.1.	Checking for gas leaks.	18
6.2.	Checking the flame appearance.	19
7.	MAINTENANCE AND UPKEEP	19
7.1.	Testing and cleaning.....	19
7.2.	Glass cylinder cleaning	20
8.	TROUBLESHOOTING.....	20
9.	PRESSURE ADJUSTMENT	22
10.	ELECTRICAL DIAGRAMS.....	27
11.	TECHNICAL SPECIFICATION	28
12.	MANUFACTURER'S CONTACT DETAILS.....	29
13.	DISTRIBUTOR'SCONTACT DETAILS	29

1. INTRODUCTION

The GaLiO Fire Pit Corten fireplace is a decorative fuel-effect gas appliances intended only for outdoor use. It is obligatory to acquaint oneself with the below installation manual and user's manual before committing to the installation and use of the GaLiO Fire Pit Corten fireplace. This manual is to be kept safe for the lifetime of the device. The Planika company designs and manufactures gas devices that meet the highest standards of quality, and safety. The device meets the essential Gas appliances General requirements of the AS/NZS 5263.0:2017 and must be installed in accordance with AS/NZS 5601.

Each gas fireplace produced by Planika is subjected to factory quality control, during which it undergoes rigorous safety tests. Materials of the highest quality used for its production guarantee the user a smooth and reliable functioning of the device.

The device is delivered together with the instruction manual and assembly instructions. The assembly instructions provide the necessary information to install the device in such a way that it works properly and safely. In addition, you can find technical data about the device, information on its maintenance and possible failures that may occur, along with their possible causes and how to resolve them.

WARNING! The installer must be a certified and qualified specialist in gas heating and electricity and should have all the qualifications required by local law.

CE Declaration of conformity

We hereby declare that both the design and construction of a gas heating device manufactured by **Planika Sp. z o.o. (with registered office at Bydgoska 38, 86-061 Brzoza, Poland)** meet the essential requirements contained in the Directive and the Ordinance on gas appliances.

Product: Gas device with decorative combustion effect for outdoor use

Type Galio Insert, Galio Corten , Galio Corten Remote, Galio Fire Pit Insert , Galio Fire Pit Insert Remote, Galio Fire Pit Corten , Galio Fire Pit Corten Remote

Standards: AS/NZS 5263.0:2017

The notified body: IAPMO R&T Oceana (7-11 Fullard Road, NARRE WARREN VIC. 3805 AUSTRALIA) has issued the certificate no. GMK10583 for the above mentioned devices.

The company's quality control system guarantees that the mass-produced devices meet the essential requirements of the applicable Directives and Regulations as well as the standards contained therein. This Declaration is annulled if any modifications are made to the device without the prior written consent of Planika.

Brzoza 14.11.2019

 **PREZES ZARZĄDU**
Jarosław Dąbrowski

Chairman of the Board

Jarosław Dąbrowski

INSTALLATION NOTICE

- The installation of this appliance is only to be carried out by an authorized person in accordance with the Manufacturers Instructions, local gas fitting regulations, AS/NZS5601.1 installation code for gas burning appliances and any other relevant statutory regulations.
- In all cases the installation of this appliance shall meet the requirements as set out in AS/NZS5601.1

IMPORTANT SAFETY NOTICES

- **DO NOT PLACE ARTICLES ON OR AGAINST THIS APPLIANCE.**
- **DO NOT USE OR STORE FLAMMABLE MATERIAL NEAR THE APPLIANCE.**
- **DO NOT SPRAY AEROSOLS IN THE VICINITY OF THIS APPLIANCE WHILST IT IS IN OPERATION.**
- **DO NOT MODIFY THIS APPLIANCE.**
- **THIS APPLIANCE IS DESIGNED TO OPERATE WITH LUMINOUS FLAMES. THIS MAY EXHIBIT SLIGHT CARBON DEPOSITS. THIS IS A NORMAL CONDITION AND IS NOT COVERED BY WARRANTY THE GUARD IS FITTED TO THIS APPLIANCE TO REDUCE THE RISK OF FIRE OR INJURY FROM BURNS AND NO PART OF IT SHOULD BE PERMANENTLY REMOVED. FOR PROTECTION OF YOUNG CHILDREN OR THE INFIRM, A SECONDARY GUARD IS REQUIRED.**

WARNING

This fireplace has a naked flame, care should be taken when it is operating if children or the infirm are in close proximity. A safety screen is recommended if constant supervision is not possible. It is recommended that a secondary guard complying with AS-NZS2286 be installed.

The appliance is not intended for use by persons (including children) with reduced physical, sensory or mental capabilities, or lack of experience and knowledge, unless they have been given supervision or instruction concerning use of the appliance by a person responsible for their safety. Children should be supervised to ensure that they do not play with the appliance.

2. SAFETY INSTRUCTIONS

- Read the instructions before using the appliance.
- Use outdoors only.
- The GaLiO Fire Pit Corten fireplace should be installed and serviced annually according to the below installation manual as well as enforced national and local laws regarding gas safety (installation and use).
- One needs to assess whether the data on the product plaque complies with the local type of gas and pressure.
- Do not change the structure of the device or its sealed elements nor modify the default settings of the GaLiO Fire Pit Corten fireplace.
- Do not set any additional imitation blocks nor any glowing coal fragments on the burner or in the combustion chamber.
- A CO₂ or a powder fire extinguisher needs to be placed near the device.
- During the first ignition the GaLiO Fire Pit Corten fireplace needs to be burnt on maximum level for a few hours in order for the elements to acquire correct temperature and for the remains of paint, lacquer and lubricant to evaporate.
- The appliance must be fixed in position and not moved.
- GaLiO Fire Pit Corten has been designed for decorative purposes. The surface of the GaLiO Fire Pit Corten fireplace including the glass screens may get hot (up to 100 degrees Celsius) with the exception of the side walls of the appliance and the control panel. **WARNING!!!** Parts of the device that are easy to reach may be very hot. Keep children away from the device.
- Glass panels must be installed when GaLiO Fire Pit Corten is in use.
- This appliance must be kept away from flammable materials during use. Do not place any combustible materials within a distance of 1 m of GaLiO Fire Pit Corten and 2 m over the appliance (Figure 1).

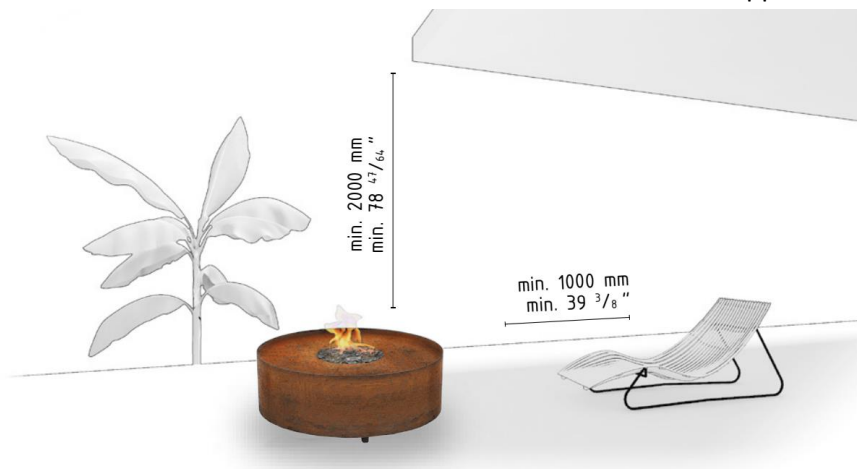

Figure 1: Minimum distance to flammable materials

- When the GaLiO Fire Pit Corten fireplace is on it's not to be exposed to rain.
- When not being used the GaLiO Fire Pit Corten is to be protected from atmospheric conditions and the main valve of the gas cylinder needs to be turned off.
- If the GaLiO Fire Pit Corten is not in use for a longer period of time (e.g. winter time), we advise you to protect it with a cover.
- Corrosion of the coating of the base of GaLiO Fire Pit Corten is a natural process resulting from the characteristics of the Corten steel which the fireplace is made of. It is an additional protective layer of the appliance against the negative influence of unfavorable weather conditions.
- Other parts of the GaLiO Fire Pit Corten fireplace are made of stain resistant material.
- Never leave a turned on GaLiO Fire Pit Corten without supervision.

- The GaLiO Fire Pit Corten fireplace needs to be installed in a place inaccessible for children, unauthorised persons or animals for the direct contact with the flame or hot parts of the device to be impossible.
- In case of heavy wind the GaLiO Fire Pit Corten fireplace needs to be immediately turned off and one needs to await until the heavy wind passes.
- In case of noticing any sort of gas leaks the fireplace as well as the main valve of the gas cylinder need to be turned off.
- After use turn off the gas cylinder valve.

2.1 Safety instruction regarding the use of the gas cylinders.

- Use only the type of gas and pressure specified by the manufacturer.
- The gas cylinders should always be placed in a vertical position – during use and transport.
- Always store the gas cylinder in an easily accessible place to allow its immediate turn-off.
- During the installation process do not allow an open flame or any ignited object to reach the gas cylinder.
- The gas cylinder must be located in accordance with AS/NZS 5601 and AS/NZS 1596.
- Leaks should be found with the use of a cleaning liquid and water. If bubbles form on the surface that means that there's a leak that must be fixed before operation.
- Use only approved and certified hose and regulator assemblies, check condition before each use and replace every 2 years.
- Ensure any hoses are kept away from sharp edges and hot surfaces. Refrain from bends and twists over its full length.
- Remember that the LPG bottle should be stored in a well-ventilated place. LPG gas is heavier than air and its accumulation near the bottom surface may generate an explosive mixture.
- The housing in which the LPG bottle is (optionally) placed needs to have an appropriate ventilation. The housing needs to have upper and lower ventilation (minimum 200cm² each, in accordance with AS/NZS 5601.1).
- The gas cylinder needs to be shut if the fireplace is not being used.
- Filling the gas cylinders is to be commissioned to certified gas filling stations.
- Replacement of empty cylinders for full ones is to be conducted only in authorised locations.

3. INSTALLATION

3.1. Box contents

- 1x complete GaLiO Fire Pit Corten gas fireplace
- 1x remote control (if delivered)
- 1x Touch panel (installed)
- 4x AA Batteries
- 2x AAA Batteries (if remote delivered)
- 4x bag of decorative stones
- 1x AS/NZS 1869 hose assembly – installed (only LPG version)
- 1x pressure regulator– installed (only LPG version)
- 1x installation manual and user’s manual
- 1x Tempered glass cylinder

3.2. Unboxing and installation

- The contents of the boxes need to be carefully unwrapped from the foam foil.
- Remove the bags with decorative stones from the burner reservoir and place them away from it.
- Remove the Styrofoam placed on the unit.
- Carefully lift the appliance and pull out the glass shield wrapped in cardboard from the inside of the GaLiO Fire Pit Corten.
- Check the completeness of the elements with the contents list.
- Make sure that the device nor its elements weren’t damaged during the transportation (if they were, notify the supplier).
- Place GaLiO Fire Pit Corten on a flat, paved surface outside of the building, preferably on the place of final installation. Leave sufficient space on the side of the appliance where control panel is located (minimum 1 m).
- The decorative stones are to be scattered evenly around the reservoir to completely cover the burner of the fireplace.
- **WARNING!!!** The stones may not cover or be placed inside the device protecting the ignition unit (Photo 1).
- It is forbidden to place any other decorative stones which are not supplied by the manufacturer.
- Delivered stones (Silicon Carbide – SiC, content 85%-95%).

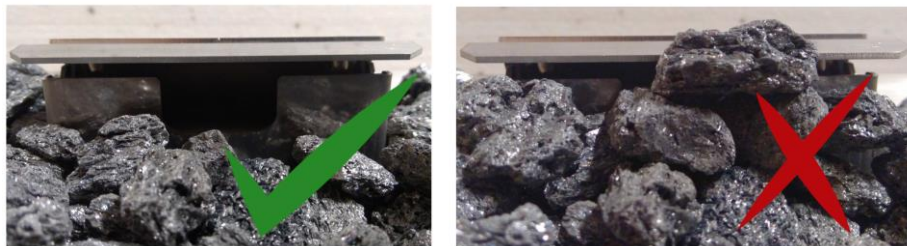

Photo 1

- Carefully install the side glass cylinder (See point 4.1).
- In the case of GaLiO Fire Pit Corten powered with natural gas, to obtain the optimum image of the flame, cover the burner with a single layer of decorative stones leaving some spaces uncovered of approximately every 10 cm (Photo 2).



Photo 2

- If all the points were completed according to the instruction the gas bottle can be now connected

4. MONTAGE

WARNING!!! All elements above the fireplace need to be made of non-flammable materials.

- Select a location where the outdoor fire can be supervised during operation.
- The outdoor fire is suitable for outdoor use only and must not be used indoors.
- An isolation switch must be fitted at the appliance or on an adjacent wall to allow for emergency shutdown and maintenance.
- Installation must meet Australian gas codes AS/NZS5601.1-2013.
- Do not install under trees or overhanging branches.
- Do not install under eaves, overhang or ceilings.
- Ensure adequate space around the fire to enjoy the flame from a safe distance from the heat and flame.
- Appliance should be covered or protected in wet weather. Not suitable for use in wet or windy weather.

Only use this appliance in an above ground open air situation with natural ventilation, without stagnant areas, where gas leakage and products of combustion are rapidly dispersed by wind and natural convection.

Any enclosure in which the appliance is used shall comply with the following:

- An enclosure with walls on all sides, but at least one permanent opening at ground level and no overhead cover.
- Within a partial enclosure that includes an overhead cover and no more than two walls.
- Within a partial enclosure that includes an overhead cover and more than two walls the following shall apply.
 - at least 25% of the total wall area is completely open, and
 - at least 30% of the remaining wall area is open and unrestricted
- In the case of balconies, at least 20% of the total wall area shall be and remain open and unrestricted.
- This appliance shall not be used or installed indoors.
- The following figures are diagrammatical representations of outdoor areas

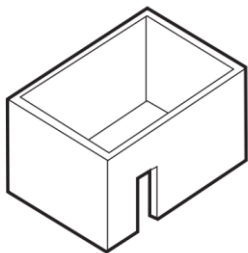

Example 1

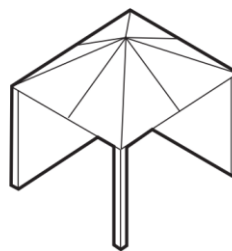
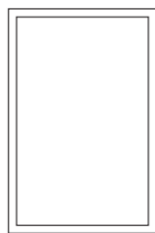

Example 2

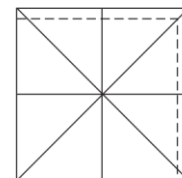

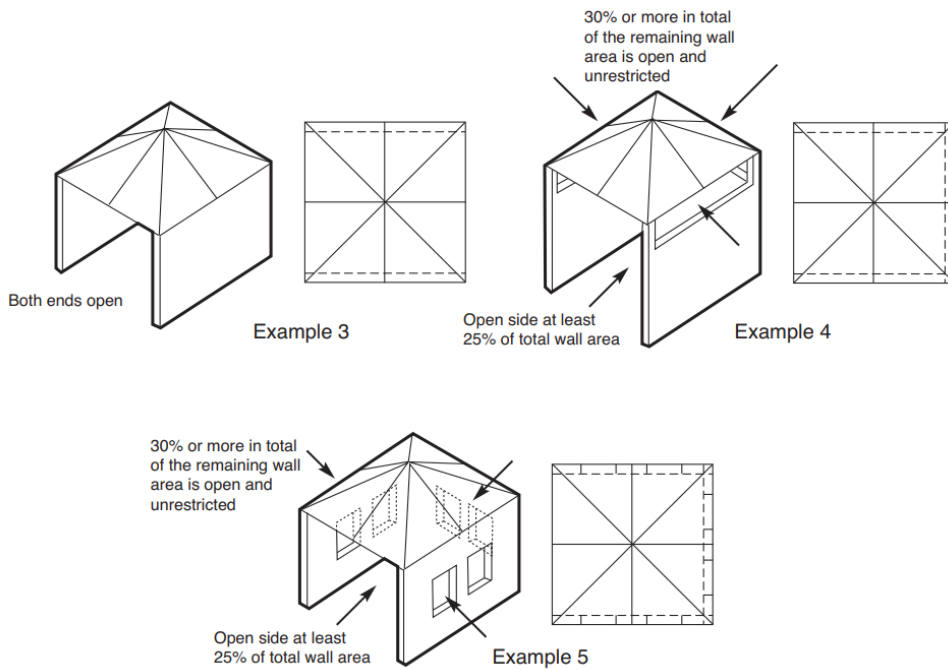

Gas fire pit minimum height must comply with:

- A gas fire pit with a burner less than 1m above the ground must be guarded to the full height of the flame such that a child aged between 2 and 6 years of age cannot gain access to the flame when assessed in accordance with IEC Guide 117.
- A guard incorporated into an appliance to comply with requirement 2 (above) must be an integral part of the appliance.

All necessary information concerning the touchable surfaces of the equipment, including the following, shall be gathered:

- Classification of surface temperatures as hot, moderate or cold
- Material and texture of the surface
- All normal operating conditions of the equipment including the setting that results in maximum temperatures of the touchable surfaces
- The probability of contact, taking into account the arm's reach of a person shown in below Figure and Table

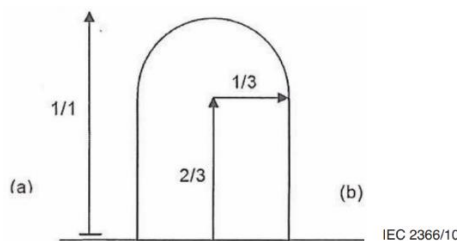

Figure - Arm's reach

The distance is interpreted as either a fully stretched person (a) or a person reaching for an item (b)

Age (Years)	Arm's reach in the vertical direction (see (a) of Figure measured from the floor (m))
Children from 2 years to less than 6 years	1,5

4.1. Installation of glass screens

- Carefully remove cardboard and foam foil from the glass cylinder.
- Remove all contaminations from the glass shields which could burn out on the glass during operation of the GaLiO Fire Pit Corten (in particular fingerprints).
- Protective glass cylinder shall be installed on the top of the burner.
- Place glass cylinder on the 3 mounting bracket at secure it gently with the 4 screws

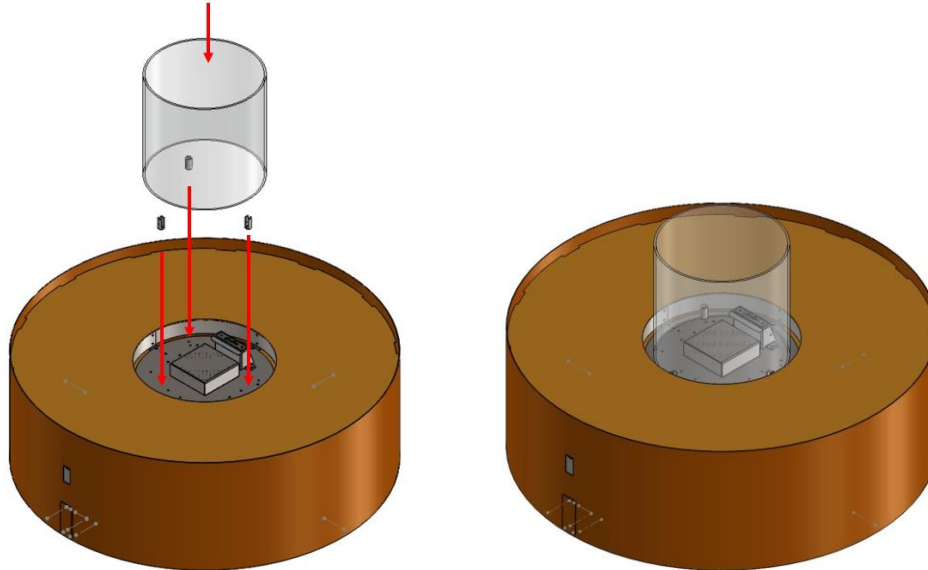

- Remove the glass shield only in case of damage of the glass.

4.2. Installation of the gas linkage

Warning!!! The installation and service needs to be conducted by a qualified professional, a company or the gas supplier.

Before proceeding with the connection of the gas cylinder to the fireplace all activity regarding the correct placement and installation of the GaLiO Fire Pit Corten needs to be already performed. Place the gas piping/hose away from hot or sharp edges and make sure any flexible connections are not twisted, located out of pathways or in areas where the hose may be subject to accidental damage and installed in accordance with AS/NZS 5601.1.

4.2.1. Natural gas connection

First and foremost, make sure that the connecting device is designed to supply a gas suitable for the type placed in the gas installation. All necessary information regarding the desired parameters of the gas are found on the rating plate of the device. Before connecting the gas supply, it is necessary to blow them to remove any remaining metal filings and other contaminants from inside. Automatic gas control system should be protected from moisture and dust. These factors may cause irreparable damage to the individual components. The pipe supplying gas to the fireplace should be equipped with a ball valve with a recommended diameter of 1/2 inch. The individual elements of the gas installation cannot be sealed using Teflon tape or PTFE tape.

The gas valve on the gas pipe must be installed in accordance with AS/NZS 5601.1. Before connecting the gas, make sure that the gas pipes and connections have no dirt. Gas connection is finished with external thread 3/8 ". Regarding gas connection, the following requirements shall apply:

- You must use the gas pipe with the correct dimensions, so there is no pressure loss.
- Ball gas valve should be installed in an easily accessible place.

4.2.2. Connection and replacement of the gas cylinder (LPG version)

The GaLiO Fire Pit Corten is delivered together with an AS/NZS 1869 certified hose assembly which, on one end is connected to the valve of the appliance and on the other end to the AS 4621 certified 2.75kPa regulator (POL connection) ready to be connected to the gas cylinder. The hose and regulator assembly must be checked at each time a new cylinder is connected, for any damage or deterioration such as cracks, cuts, abrasions including the condition of the o-ring seal. If in any doubt contact the place of purchase for a suitable replacement.

The GaLiO Fire Pit Corten fireplace is suitable for use with 4.5kg-9kg propane cylinders.

WARNING!!! NEVER use an unstable gas connection or a regulator for other gas pressure.

Where an AS/NZS 1869 certified hose assembly is connected to piping ensure it is protected during servicing with a restraint chain/tether 80% of the hose length.

5. OPERATING INSTRUCTIONS

5.1. General Notes

The Galio Fire Pit Corten fireplace has a remotely control valve with a built-in ignition for the pilot flame. The flame height of the main burner may be appropriately regulated by Touch Panel or remote control (if delivered).



Photo 3: Hand-held transmitter and Touch Panel

5.2. Setting up signal code

WARNING! You only need to set up the signal code once. It is not necessary when changing the batteries of the hand-held transmitter or receiver. **The appliance is delivered already configured and ready to work.**

In case of lost or damaged of hand-held transmitter the new one has to be programmed and the receiver must first learn the hand-held transmitter's signal code before the first use.

Press and hold the receiver's reset button until you hear two (2) beeps. After the second, longer beep, release the reset button. Within the subsequent 20 seconds press the button „▼“ on the handset. **"CONN" and a running number from 1 to 8 are displayed** on the handset confirming the synchronization **and data exchange** is in process **Two (2) short beeps confirm the code is set.** After successful synchronization the current state of the gas fire is displayed on the handset.

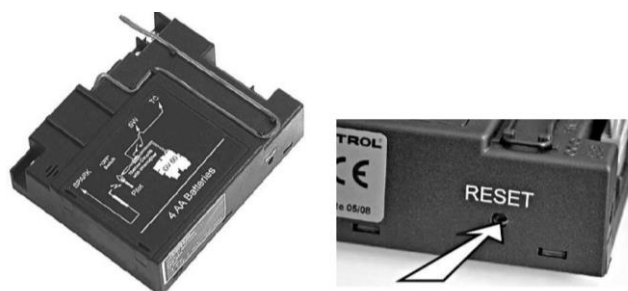

Receiver "RESET" button

5.3. Replacing the batteries

If the batteries are inserted incorrectly, the electronics or drive may be irreparably damaged. Only replace the batteries when the appliance has been completely switched off.

NOTE: If the appliance is equipped with a 230 VAC connection, no batteries are present in the receiver or in battery box.

- The batteries are placed battery holder located at the bottom of Galio Fire Pit Corten. (See Photo 5).



Photo 5: Receiver batteries containers

- Unscrew the cover of the battery container with a screwdriver and remove the battery box outside



Photo 6: Removing of the battery container

- Unscrew the cover and replace the batteries in the container.

WARNING! Remember about proper polarization of the batteries.



Photo 9: Replacing the batteries in the container





- Screw the cover back and place container back.

5.4. Remote control (if delivered)















Galio Fire Pit Insert can be operated by radio remote control. This comprises a hand-held transmitter and a receiver. The receiver is part of the gas control block assembly.

- Electrical connections and batteries:
 - Hand-held transmitter: 2x 1.5V AAA battery
 - Receiver: 4x1.5V AA battery or 6 VDC
- **WARNING!** Without using a mains adapter, battery replacement is recommended at the beginning of each heating season. Old or dead batteries should be removed immediately. If left in the unit the batteries can overheat, leak, and / or explode. Do NOT expose batteries (including during storage) to direct sunlight, excessive heat, fire, moisture, or severe impact. Each of these conditions can cause the batteries to overheat, leak, and / or explode. Batteries must be kept within their recommended temperature limits. Ambient battery temperature range: 32 °F to 131 °F[0 °C to 55 °C].
- The hand-held transmitter batteries have a service life of approx. one year. We recommend you use alkaline batteries. Rechargeable batteries are not permitted.
- To replace batteries:
 - Open the cover on the back of the remote control.
 - Remove the batteries from the battery compartment.
 - Place two new 1.5V batteries (LR03 or AAA type) as indicated in the battery compartment.
 - Close the cover







5.4.1. Setting fahrenheit or celsius

	<p>a. To change between ° C and ° F, press  and  buttons simultaneously.</p> <p>NOTE: Choosing ° F results in a 12 hour clock. Choosing ° C results in a our clock.</p>
---	--

5.4.2. Setting the time

	<ol style="list-style-type: none">1. Press  and  buttons simultaneously. Day flashes.2. Press  or  button to select a number to correspond with the day of the week (e. g. ¹ = Monday, ² = Tuesday, ³ = Wednesday, ⁴ = Thursday, ⁵ = Friday, ⁶ = Saturday, ⁷ = Sunday).3. Press  and  buttons simultaneously. Hour flashes.4. To select hour press  or  button.5. Press  and  buttons simultaneously. Minutes flash.6. To select minutes press  or  button.7. To confirm press  and  buttons simultaneously or wait.
--	---





5.4.3. Child proof

	<p>ON:</p> <ol style="list-style-type: none">1. To activate press  and  buttons simultaneously.  displayed and the handset is rendered inoperable, except for the off function. <p>OFF:</p> <ol style="list-style-type: none">2. To deactivate press  and  buttons simultaneously.  disappears.
---	---

5.4.4. Switch the Fire ON and OFF

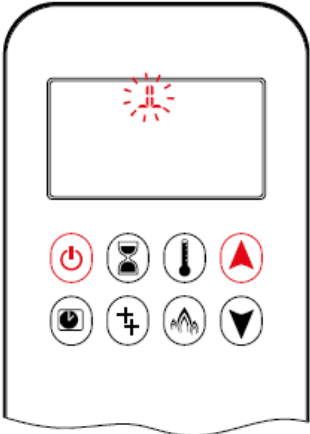
Before operating make sure MANUAL knob on the GV60 valve is in the **ON**, full counter clockwise position.

WARNING! When the pilot light is ignited, the motor turns automatically to maximum flame height. If the pilot flame goes out for any reason, wait for 5 minutes before attempting to re-light it. If the pilot does not stay lit after several tries, turn the main valve knob to **OFF**.

	<ol style="list-style-type: none">1. Open the valve of the gas cylinder (or gas supply valve in the gas pipe).2. Press  button (One Button Ignition) or  and  button simultaneously (Two Button Ignition) until two short beeps and a blinking series of lines confirms the start sequence has begun; release button(s).3. Main gas flows once pilot ignition is confirmed.4. Handset automatically goes into Manual Mode after main burner ignition.5. Press  button to turn OFF.6. NOTE: A new ignition is possible after the OFF icon stops flashing.
---	--



- This can take few seconds to ignite to pilot flame especially when you have replaced and installed a new LPG gas cylinder.
- If the pilot light does not ignite after 3 ignition attempts close the gas tap and warn the fitter.
- Once the pilot light is burning, the main burner must ignite within 10 seconds automatically. If this does not happen, immediately close the gas tap and warn the fitter.
- If the main burner ignites with a pop immediately close the gas tap and warn the fitter.
- If the appliance is not to be used for some time, please close the gas supply valve in the gas pipe (or valve of the gas cylinder).
- **WARNING!** If the pilot flame goes out for any reason wait for 5 minutes before attempting to re-light it.

WARNING!!!



- Under conditions of increased humidity (rain, breeze, fog, dew, etc.), there may be some temporary problems with switching on the fireplace. This is a normal phenomenon associated with the dampening of the ignition element.
- Before switching on the fireplace, wait until the ignition element has dried completely.
- You can speed up this process by blowing the pilot flame with compressed air to remove the accumulated moisture. The properly fired pilot flame consist of 3 smaller parts.





5.4.5. Stand-by mode (Pilot flame)

	<ol style="list-style-type: none">1. Press and hold  button to set appliance to pilot flame.
---	---



5.4.6. Flame height adjustment

	<ol style="list-style-type: none">1. To increase flame height press and hold  button.2. To decrease flame height or to set appliance to pilot flame, press and hold  button.
--	---











5.4.7. Flame height directly to minimum position

	<ol style="list-style-type: none">1. To go to low fire, double-click  button. LO is displayed. <p>NOTE: Flame goes to high fire first before going to low fire.</p>
---	--

5.4.8. Flame height directly to maximum position

	<ol style="list-style-type: none">1. To go to high fire, double-click  button. HI is displayed.
---	---

5.4.9. Countdown timer

	<p>ON / SETTING:</p> <ol style="list-style-type: none">1. Press and hold  button until  displayed, and hour flashes.2. To select hour press  or  button.3. To confirm press  button. Minutes flash.4. To select minutes press  or  button.5. To confirm press  button or wait. <p>OFF:</p> <p>Press  button,  and countdown time disappear.</p>
---	--

5.4.10. Automatic Turn Down To Pilot

3 Hour No Communication Function

The valve will turn to pilot flame if there is no communication between handset and receiver for a 3 hour period. The fire will continue to function normally when communication is restored.

Receiver Overheating

- Powered by mains adapter: The valve turns to pilot flame if the receiver temperature is higher than 176 °F (80 °C). If batteries are installed in the receiver in this configuration the temperature must not exceed 60 °C.
- Powered by batteries and/or connected to the V module: The valve turns to pilot position if the temperature in the receiver is higher than 140 °F (60 °C).

NOTE: When the receiver temperature is below 140 °F (60 °C), the main burner can be turned ON manually.

5.4.11. Automatic Shut Off

Countdown Timer

At end of countdown time period, the fire shuts off. The Countdown Timer only works in Manual, Thermostatic, and Eco Modes. Maximum countdown time is 9 hours and 50 minutes.

Low Battery Receiver

With low battery power in the receiver the system shuts off the fire completely. This will not happen if the power supply is interrupted.

On-Demand Pilot

- This green feature eliminates gas energy consumption during extended appliance inactivity. When the appliance is inactive for an extended period of time the system automatically extinguishes the pilot. This feature helps the consumer realize cost benefits by automatically eliminating energy consumption during non-heating months and limited use.
- The programmed length of inactivity to activate the system is specified by the appliance manufacturer and cannot be altered in the field.

5.5. Touchpad

Depending on customers preferences Galio Fire Pit Corten Remote may be additionally operated Touch panel.



Photo 10: Touch panel

To Turn ON Appliance

- Press **ON-OFF** button (see Photo 10) until two short beeps confirm the start sequence has begun; release button.
- Once pilot ignition is confirmed, there is main gas flow.



Standby Mode (Pilot Flame)

- Press and hold  **DOWN** (small flame) button to set appliance at pilot flame.

To Turn OFF Appliance

- Press **ON-OFF** button.

Flame Height Adjustment

- Press and hold  **UP** (large flame) button to increase flame height.
- Press and hold  **DOWN** (small flame) button to decrease flame height or to set appliance at pilot flame.

6. TESTING

WARNING!!! NEVER TURN ON THE DEVICE IF THE CHARACTERISTIC SMELL OF GAS IS PERCEPTIBLE.

If you smell gas during the operation of the fireplace turn off the device immediately and cut off the gas supply from the gas cylinder by shutting its valve.

6.1. Checking for gas leaks.

- Check if all connections are airtight.
- To do that apply all connections with soapy water (or water with another foamy substance) or with a professional spray for leak detection.
- If air-bubbles are present that means the connection has a leak.

- Remove the leaks in the identified spaces.
- Check for leaks once again.
- After the inspection dry the inspected connections.
- The device may only be used again after all leaks are removed.
- **If the problem happens again please contact the dealer.**

6.2 Checking the flame appearance.

- Burn the GaLiO Fire Pit Corten on max flame height and check the appearance of the flame. Ensure test point pressure is as per the data plate on the appliance and at the end of this manual.
- The flame should be linear and evenly placed on the whole length of the main burner.
- If visible gaps are present or there are substantial differences in flame height turn off the fireplace and after the device is cooled adjust the placement of decorative stones in such a way for them to be evenly placed on the whole surface of the main burner.
- **WARNING!!!** Stones must not cover the area between the burner and pilot cover, which houses the ignition and the pilot flame.
- Turn on the fireplace and check the appearance of the flame once again.

7. MAINTENANCE AND UPKEEP

We recommend cleaning the pilot flame and the main burner unit before the device is started again and after long intervals of inactivity.

7.1. Testing and cleaning

Please check and clean as necessary:

- The main burner - if necessary, remove broken parts of stones and dust.
- Pilot burner and thermo-couple (if necessary, remove the existing sediment). In the event of visible damage contact your dealer.
- Igniter - gap between igniter and pilot flame should not be bigger than 5 mm.
- Glass cylinder – check for dirt smudges or possible scratches or cracks. If cracks are present replace the glass cylinder for a new one. To conduct this contact your dealer. Always replace the cylinder following any maintenance/servicing.
- Gas hose and pressure regulator (in case their expiry date is invalid replace these ancillaries for new ones).
- If you encountered problems with the regulator, gas hose, burner or regulation valves do not try to fix these parts. Contact your place of purchase, an authorised service or an importer in order to acquire genuine spare parts. To ensure the device is working efficiently use only original spare parts.
- Ensure controls, burners and circulating air passageways of the appliance are kept clean for safe operation.

7.2. Glass cylinder cleaning

Most of the existing types of smudges may be wiped with a dry cloth. In case of more substantial smudge you may use liquids normally applied to ceramic tiles or windows. Always dry the glass screen to avoid damp patches which could irreversibly embed into the glass.

WARNING!!! Avoid leaving fingerprints on the glass. They will be embedded into the glass and you will not be able to clean them.

8. TROUBLESHOOTING

WARNING! Installation, upkeep and service need to be conducted by a qualified professional with appropriate qualification, an appropriate company or the gas supplier.

PROBLEM	POSSIBLE CAUSE	CORRECTIVE ACTION
SMELL OF GAS	CLOSE THE VALVE ON THE GAS CYLINDER IMMEDIATELY. DO NOT USE THE DEVICE UNTIL LEAKS HAVE BEEN REMOVED.	
Leak detected at cylinder, regulator or other connection.	<ol style="list-style-type: none"> 1. A loose regulator linkage. 2. Leak in the gas linkage, in the regulator or on the gas knobs. 	<ol style="list-style-type: none"> 1. Tighten and test it. 2. Report this issue to service.
Burner does not ignite	<ol style="list-style-type: none"> 1. The bottle is empty. 2. Igniter linkage is not connected. 3. No ignition spark. 4. The igniter electrode is placed incorrectly opposite the igniter. 5. Gas nozzles are blocked. 6. Gas linkage is twisted. 7. Pressure regulator link is loose. 	<ol style="list-style-type: none"> 1. Replace Gas Cylinder. 2. Connect the igniter linkage. 3. Replace igniter. 4. Realign electrode and clear any surrounding debris from area. 5. Unmount burner, clean the nozzle. 6. Straighten the linkage. Keep the linkage away from the housing. 7. Tighten the link. Check for leaks.
Igniter Not Working	<ol style="list-style-type: none"> 1. Ignitor wire not connected. 2. Electrode misaligned on pilot burner 3. Igniter malfunction 	<ol style="list-style-type: none"> 1. Ensure pilot electrode wire is connected. 2. Realign electrode and clear any surrounding debris from area. 3. Replace Igniter
Low efficiency, „cracking” sounds	<ol style="list-style-type: none"> 1. The bottle is empty. 2. The nozzles of the burner are blocked. 	<ol style="list-style-type: none"> 1. Replace Gas Cylinder. 2. Unmount the burner, clean the nozzle.
Thumping sounds made by the regulator.	The cylinder valve has opened rapidly.	Unfasten the bottle valve slowly.
A vivid/ bright orange and smoky flame of the burner.	Holes blocked in the apparatus producing the gas and air mixture.	Unmount the burner and clean/ unblock the apparatus’ holes.

There are many factors that may affect the malfunction of the gas insert. To exclude a possible fault in the unit or the automatic gas control system, make sure that the fireplace is connected according to these instructions.

Below table summarizes possible failures that may occur, possible causes and ways to solve them.

Failure code	Message shown in app	Description	Possible cause
F02	F02 Contact Service.	Wiring Motor and/or Microswitch.	No Motor end stop found Wiring to Motor Microswitch connection or function Bent Motor Knob
F03	F03 Contact Service.	Thermocouple wiring wrong or interrupted, or kill switch open.	Thermocouple wiring wrong or interrupted ON/OFF switch at Valve open
F04	F04 Ignition Sequence Malfunction. Wait 1 minute. Retry ignition.	No pilot flame within 30 sec; Remark: after 3 times failure F06 will be created.	No gas supply Air in pilot supply line No spark Wrong polarity in Thermocouple wiring
F06	F06 Contact Service.	No pilot flame within 30 sec for 3 times within 5 Minutes.	No gas supply Air in pilot supply line No spark Wrong polarity in Thermocouple wiring
F10	F10 Contact Service.	2nd Thermocouple did not sense flame.	Logs out of position
F12	F12 Contact Service.	Limit temperature exceeded (T > 60 °C); Motor turns down to pilot.	V Module connected Receiver equipped with back up batteries
F13	F13 Contact Service.	Limit temperature exceeded (T > 80 °C); Motor turns down to pilot.	V Module not connected Receiver not equipped with back up batteries
F14	F14 Contact Service.	Receiver software doesn't support a 2nd Thermocouple.	Wrong Receiver type
F15	F15 Contact Service.	2nd Thermocouple is not connected to the Receiver.	- Wiring of 2nd Thermocouple not connected or damaged
F16	F16 Handset out of range.	No temperature value from Handset found for 1,5 h.	No Handset in range
F17	F17 Contact Service.	Measure range malfunction Vcc > 7,25 V.	Wrong or malfunctioning Mains Adapter
F19	F19 Contact Service.	Pilot drops when Motor opens the main gas.	Not enough thermovoltage Bad Thermocouple Low inlet pressure Valve

Failure code	Message shown in app	Description	Possible cause
F26	F26 Contact Service.	Motor up prohibited after ignition / Fan at level 4 for 10 minutes (T > 60/80 °C).	- Receiver temperature still above 60/80 °C
F28	F28 5 Day Shut OFF.	5d Timer expired or switched off at low batteries.	No Motor turn for 5 days Empty Receiver batteries
F31	F31 Contact Service.	Electronic malfunction.	Misconnection, short, high voltage Overheating
F41	F41 Check Wi-Fi.	No or bad Wi-Fi connection.	No or bad Wi-Fi connection
F42	F42 Check Wi-Fi.	No myfire Wi-Fi box found.	No power myfire Wi-Fi Box is not connected to the Home Network Incorrect myfire Wi-Fi Box version
F43	F43 No Receiver Connected. Contact Service.	No Receiver connected to myfire Wi-Fi Box or bad connection.	Defect or loose wire between Receiver and myfire Wi-Fi Box
F44	F44 Missing temperature Sensor. Contact Service.	No Temperature Sensor found (Handset or NTC)	No Handset available or no Temperature Sensor connected

Failure code	Message shown in handset	Duration displaying	Description	Possible cause
F04	F04	4s	No pilot flame within 30 sec Remark: after 3 times failure F06 will be created.	No gas supply Air in pilot supply line No spark Wrong polarity in thermocouple wiring
F09	F09	4s	The Receiver has not been paired with the Handset.	Down arrow button was not pressed during pairing
F40	Battery Symbol	Permanent	Low battery power in Handset.	Replace Handset batteries
F46	F46	4s	No or bad connection between Receiver and Handset.	No power at Receiver Low communication range

9. PRESSURE ADJUSTMENT

Do not attempt to remove screws from the top of gas valve. Do not change any adjustments marked with tamper indicating paint. Motor knob is not to be removed.

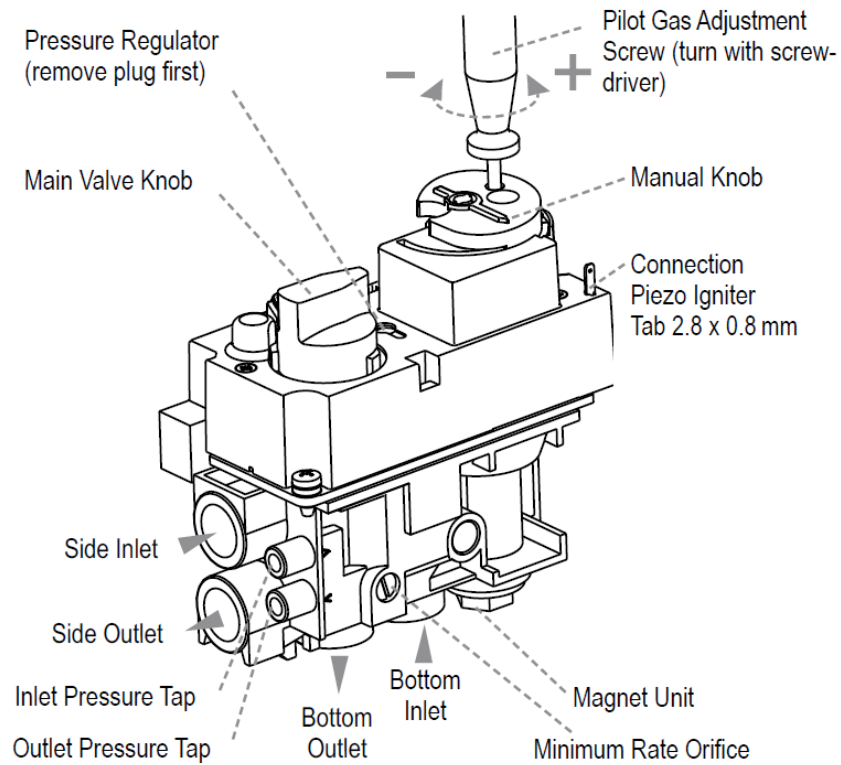

• Pilot Flame Adjustment

The pilot flow adjustment is preset to maximum at the factory. The pilot flame should envelope $\frac{3}{8}$ " to $\frac{1}{2}$ " of the thermocouple

- The adjustment screw can be reached through a hole in the MANUAL knob (see figure 21).
- Turn the MANUAL knob to the ON position.
- It is now possible to pierce through a film on the cover with a screwdriver to reach the adjustment screw beneath.
- Turn the adjustment screw clockwise to decrease or counterclockwise to increase pilot flame.

- **Outlet Pressure Adjustment (High Fire)**

- Connect a pressure manometer to the valve outlet pressure tap. Pressure tap is opened by turning the screw counterclockwise. Pressure regulator or throttle are located under the cover and can be reached by removing the plug (see figures 21 and 23).
- Turn MANUAL knob and main valve knob to the ON position.
- Turn pressure regulator adjustment screw to set required burner pressure (high fire). Pressure is increased by turning clockwise (pressure regulator models), or decreased by turning counterclockwise: LPG 1.2kPa, NG 1.0kPa

Pressure Regulator or Throttle



- After adjustment, replace the plug.
- If no other adjustments are required, close pressure tap(s) by turning the screw(s) full clockwise. Check all connections/pressure tap(s) for leaks.
- If the desired outlet pressure or flow cannot be achieved by adjusting the gas valve, check the gas valve inlet pressure using a manometer at the valve inlet pressure tap. If the inlet pressure is in the normal range, replace the gas valve; otherwise, take necessary steps to assure proper gas pressure to the valve

- **Minimum rate Adjustment**

- Connect a pressure manometer to the valve outlet pressure tap. Pressure tap is opened by turning the screw counterclockwise. Minimum rate adjustment screw is located on the top of the metal valve body.
- Turn minimum rate adjustment screw to set required burner pressure (minimum fire). Pressure is increased by turning clockwise (pressure regulator models), or decreased by turning counterclockwise: LPG 0.89kPa, NG 0.53kPa

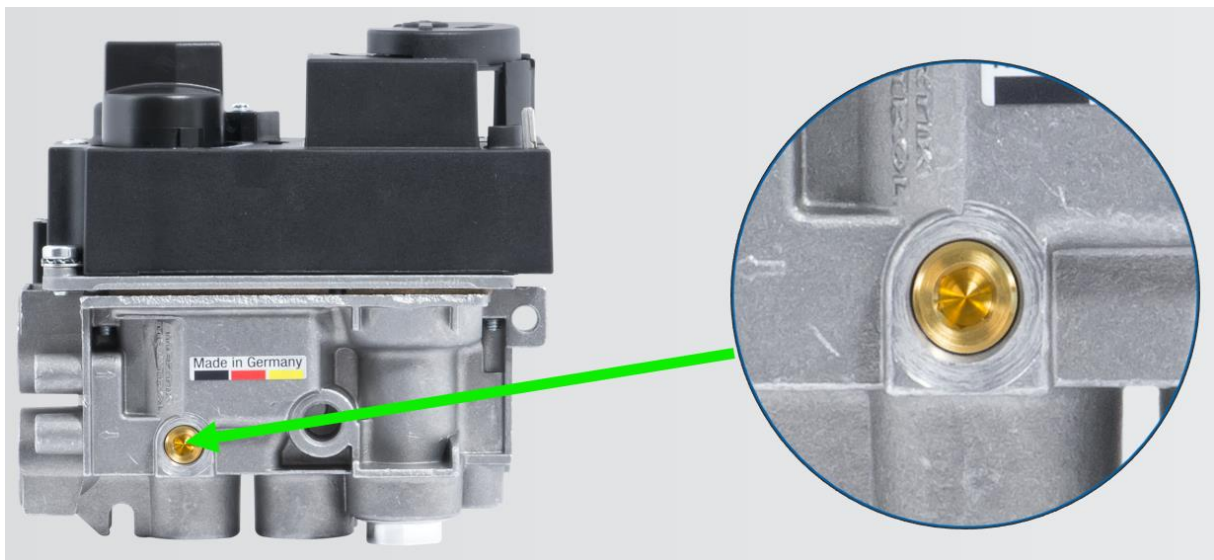

WARNING! You should never connect any device adapted to the combustion of liquefied gas to the gas network of natural gas and vice versa.

- **Pressure reading**

- Unscrew gas valve box cover using cross screwdriver.

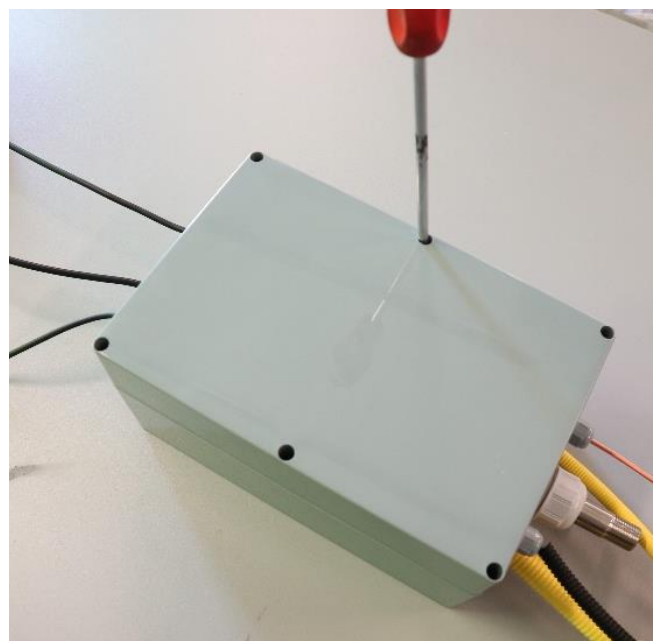

- Take off the cover.

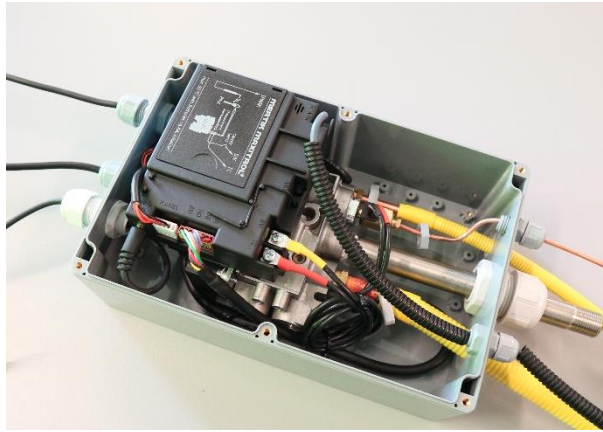

- Slightly take out the valve unit from valve box
- Unscrew the screw on the test tap by half a turn.
 - A) Inlet pressure tap
 - B) Outlet pressure tap

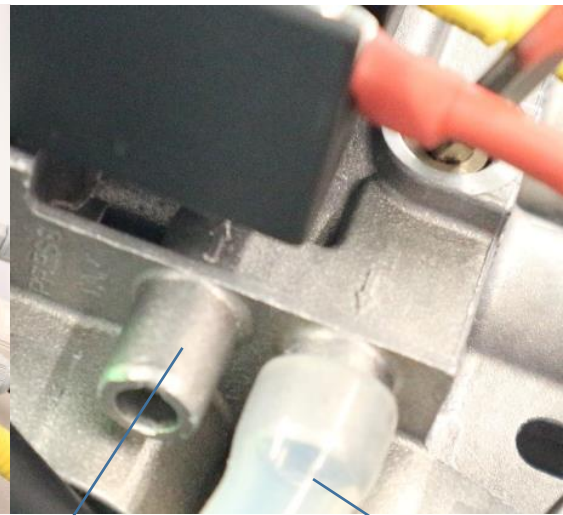
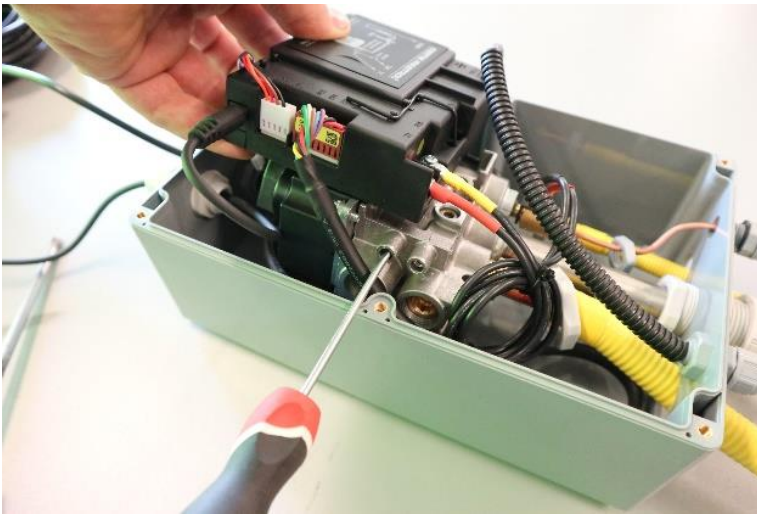

A

B

- Connect the silicon hose from measure device to the measure tap.

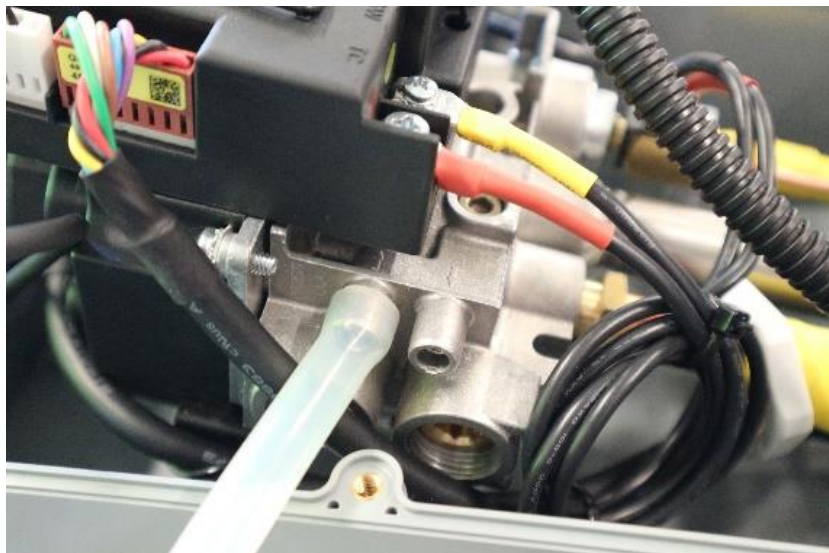

- Read the pressure value. Pressure test has to be made when fireplace is turned on with the highest flame level.

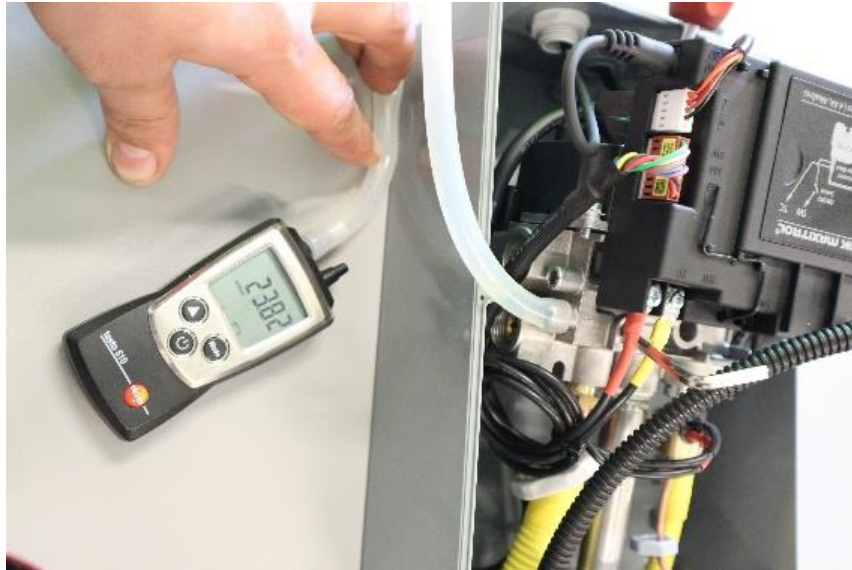

- Screw tightly the screw on the test tap
- Turn on the device and check if screw is sealed using gas detector, foam or other method.
- Put on gas valve cover and screw it back.

10.ELECTRICAL DIAGRAMS

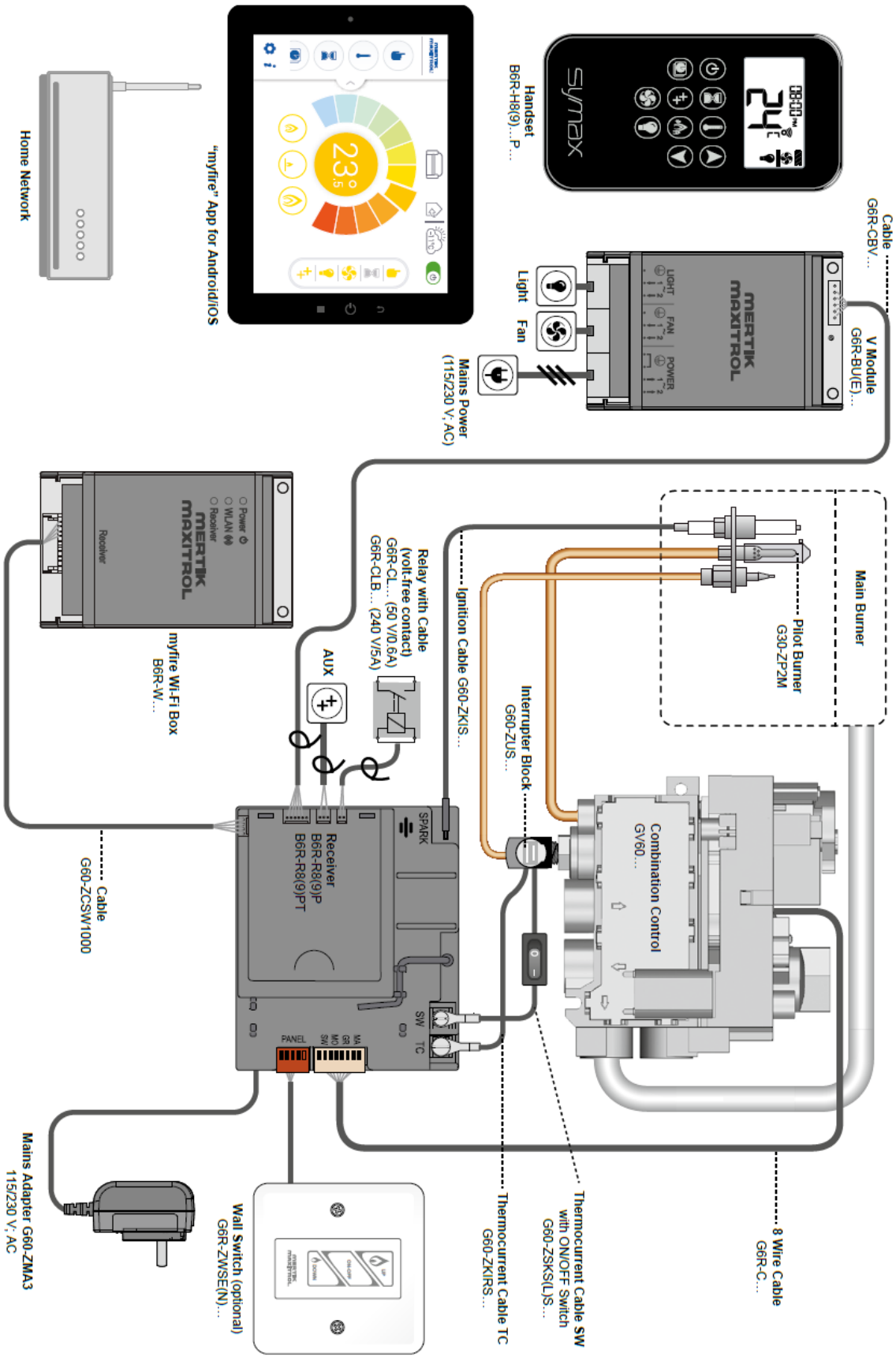

11. TECHNICAL SPECIFICATION

Manufactured by:
Planika Sp. z o.o.
Bydgoska 38
86-061 Brzoza
Poland

planika
 INTELLIGENT FIRE



Model No.	Galio Fire Pit Corten
Serial No.	FO 1012 19
Gas Type	LPG
Index	GO-AL01-00018
Date of Manufacture	11/2019
Nominal Injector Size (mm)	1.40
Pilot flame injector (mm)	0.2
Inlet Pressure (kPa)	2.75
Test Point Pressure (kPa)	1.20
Turndown Test Point Pressure (kPa)	0.89
Nominal Gas Consumption (MJ/h)	17.6
Turndown Gas Consumption (MJ/h)	14.9
Primary Aeration Setting (mm)	Half Closed

SUITABLE ONLY FOR OUTDOOR INSTALLATION

DO NOT OPERATE IN AN ENCLOSED AREA

DO NOT OPERATE IN AN UNVENTILATED AREA

DO NOT OPERATE INDOORS

DO NOT OPERATE THIS APPLIANCE BEFORE LEAK CHECKING HOSES AND GAS CYLINDER CONNECTION

TO BE INSTALLED ON FIRE RESISTANT MATERIAL

FOR OUTDOOR USE ONLY

**THE INSTRUCTIONS PACKAGED WITH THIS APPLIANCE CONTAIN IMPORTANT INFORMATION ABOUT
 INSTALLATION AND USE**

TO BE INSTALLED ONLY BY AN AUTHORIZED PERSON IF CONNECTING TO FIXED CONSUMER PIPING

Manufactured by:
Planika Sp. z o.o.
 Bydgoska 38
 86-061 Brzoza
 Poland

planika
 INTELLIGENT FIRE



Model No.	Galio Fire Pit Corten
Serial No.	FO 1013 19
Gas Type	NG
Index	GO-AL01-00019
Date of Manufacture	11/2019
Nominal Injector Size (mm)	1.80
Pilot flame injector (mm)	2 x 0.2
Inlet Pressure (kPa)	1.13
Test Point Pressure (kPa)	1.00
Turndown Test Point Pressure (kPa)	0.53
Nominal Gas Consumption (MJ/h)	17.0
Turndown Gas Consumption (MJ/h)	12.6
Primary Aeration Setting (mm)	Fully Closed

SUITABLE ONLY FOR OUTDOOR INSTALLATION

DO NOT OPERATE IN AN ENCLOSED AREA

DO NOT OPERATE IN AN UNVENTILATED AREA

DO NOT OPERATE INDOORS

DO NOT OPERATE THIS APPLIANCE BEFORE LEAK CHECKING HOSES AND GAS CYLINDER CONNECTION

TO BE INSTALLED ON FIRE RESISTANT MATERIAL

FOR OUTDOOR USE ONLY

**THE INSTRUCTIONS PACKAGED WITH THIS APPLIANCE CONTAIN IMPORTANT INFORMATION ABOUT
 INSTALLATION AND USE**

TO BE INSTALLED ONLY BY AN AUTHORIZED PERSON IF CONNECTING TO FIXED CONSUMER PIPING

12. MANUFACTURER'S CONTACT DETAILS

Company Name: Planika Sp. z o.o.
Address: Bydgoskich Przemysłowców 10
Telephone: + 48 52 364 11 60

13. DISTRIBUTOR'S CONTACT DETAILS

Company Name: Planika Australia
Address: 3/2 Cynamide st, Laverton nth, vic 3016, Australia
Telephone: + 61 415 350 564
E-mail: planikaaustralia@planikafires.com