

# Mini T

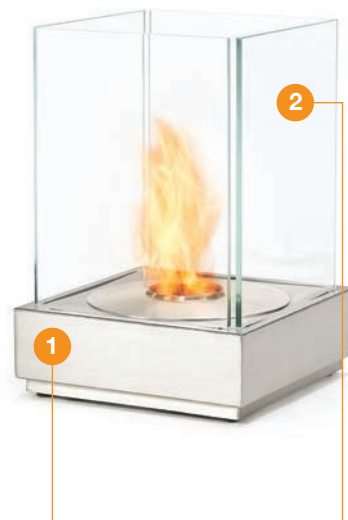

# Mini T Design features



## Environmentally-Friendly

Bioethanol fireplaces use an environmentally-friendly, renewable energy source that burns clean and delivers warming heat. You and your guests will enjoy the ambiance and tranquility of a real fire, without the hassles of burning real wood - no more embers, ash, and soot to clean up.

## Ground Fixing Brackets

Models come with fixing brackets for permanently locating into a fixed position.

## 1. Colour

Available in brushed Stainless Steel finish with a Stainless Steel Burner.

## Relocate With Ease

Bioethanol outdoor fireplaces relocate with ease, and this portability is greatly enhanced by the self contained engineering of the EcoSmart system. There is no need for a utility connection, which means you can transform the look and feel of your outdoor entertaining area when desired.

Or, leave your fireplace in a permanent position on the patio and design an enchanting outdoor space using the fireplace as the focal point. It has never been this easy to design a backyard or courtyard that feels so inviting.

## 2. Glass Fire Screen

The glass screens stabilise the flame in windy conditions and provide an added layer of safety, peace of mind and comfort.

## Quick & Easy Installation

With no installation or building works required, simply unpack, put into position, and off you go.

## Global Compliance

This model complies with existing standards in the USA and Australia. UL Listed and ACCC Safety Mandate compliant.

## Included Accessories



Jerry Can with Safety Spout & e-NRG bottle adaptor



Lighting Rod & Lighter



Jerry Can Spout Extension

## Optional Accessories









Outdoor Cover

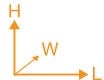

Disclaimer: All product specifications and data are subject to change without notice and believed to be correct at the time of publication. MAD Design Group (MDG), its affiliates, agents, and employees, and all persons acting on its or their behalf (collectively, "MAD Design Group"), disclaim any and all liability for any errors, inaccuracies or incompleteness contained herein or in any other disclosure relating to any product. MDG disclaims any and all liability arising out of the use or application of any product described herein or of any information provided herein to the maximum extent permitted by law. The product specifications do not expand or otherwise modify MDG's terms and conditions of purchase, including but not limited to the warranty expressed therein, which apply to these products. No license, express or implied, by estoppel or otherwise, to any intellectual property rights is granted by this document or by any conduct of MDG. Customers using or selling MDG products not expressly indicated for use in such applications do so entirely at their own risk and agree to fully indemnify MDG for any damages arising or resulting from such use or sale. Please contact authorised personnel from MDG to obtain written terms and conditions regarding products designed for such applications. Images are indicative only.

# Mini T Specifications

The ideal accoutrement for intimate gardens, alfresco dining settings, bars and restaurants.

## Burner Ventilation and Efficiency\*

 Dimensions L x W x H mm/in	 Compatible Burner	 Fuel Capacity	 Heats on Average (Indoors)	 Thermal Output Net (MAX)	 Approx. Burn Time	 Minimum Room Size
330 x 330 x 462 13 x 13 x 18.2	AB3	2.5 L [0.7 Gals]	Over 20 m <sup>2</sup> [215 ft <sup>2</sup> ]	6.14 MJ/h 5,800 BTU/h 1.7 kW	8 - 11 hours	40 m <sup>3</sup> [1,413 ft <sup>3</sup> ]

Application	Indoor & Outdoor
Surround Colour	 Stainless Steel ESF.O.MNT
Burner Colour	 Stainless Steel
Materials	Grade 304 Stainless Steel, Toughened Glass, Grade 304 Stainless Steel Burner
Approx. Weight	18.9kg [41.7lbs] Weight includes burner and fire screen.
Fuel Type	e-NRG Bioethanol / <b>e-NRG.com</b>

Not available in all countries.

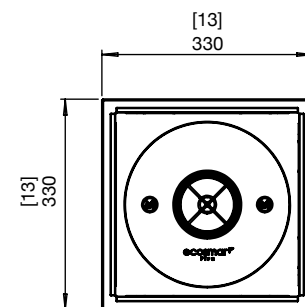
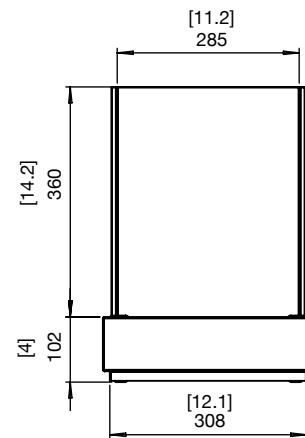

\*These values are indicative only and may vary depending on the model purchased, installation, and the seasonal resource used to manufacture e-NRG.

This model comes with fixing brackets for permanently locating into a fixed position.

This model complies with existing standards in the USA and Australia. UL Listed and ACCC Safety Mandate compliant.

## FOR MORE INFORMATION PLEASE REFERENCE THE CLEARANCE & INSTALLATION MANUAL

Disclaimer: All product specifications and data are subject to change without notice and believed to be correct at the time of publication. MAD Design Group (MDG), its affiliates, agents, and employees, and all persons acting on its or their behalf (collectively, "MAD Design Group"), disclaim any and all liability for any errors, inaccuracies or incompleteness contained herein or in any other disclosure relating to any product. MDG disclaims any and all liability arising out of the use or application of any product described herein or of any information provided herein to the maximum extent permitted by law. The product specifications do not expand or otherwise modify MDG's terms and conditions of purchase, including but not limited to the warranty expressed therein, which apply to these products. No license, express or implied, by estoppel or otherwise, to any intellectual property rights is granted by this document or by any conduct of MDG. Customers using or selling MDG products not expressly indicated for use in such applications do so entirely at their own risk and agree to fully indemnify MDG for any damages arising or resulting from such use or sale. Please contact authorised personnel from MDG to obtain written terms and conditions regarding products designed for such applications. Images are indicative only.