

# Stitch Planter Assembly/Installation

Use the dimensions to the right to determine the planter which best fits your Stitch Planter.

For best visual effect, ensure the internal pot sits below the external decorative planter lip. The void between can be filled with a custom choice of plant husk fibers or other decorative media.

Like any indoor plants, ensure extra attention and care is given when watering. Know your internal pot size and soil content and ensure over watering does not occur. Do not water outside of the internal pot area. This is important for both the plant's health and prevents excess water build up inside the planter. If the internal planter is covered with decorative media, suggest watering next to the plant roots to ensure water is delivered to the plant effectively.

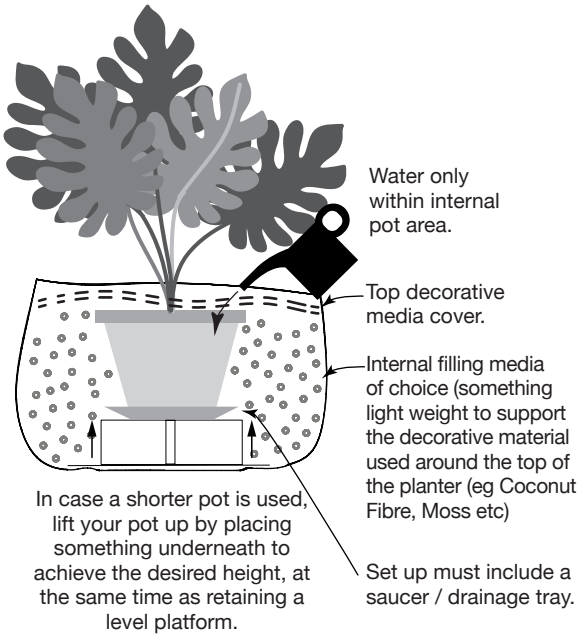

## Internal Pot - Specified Dimensions

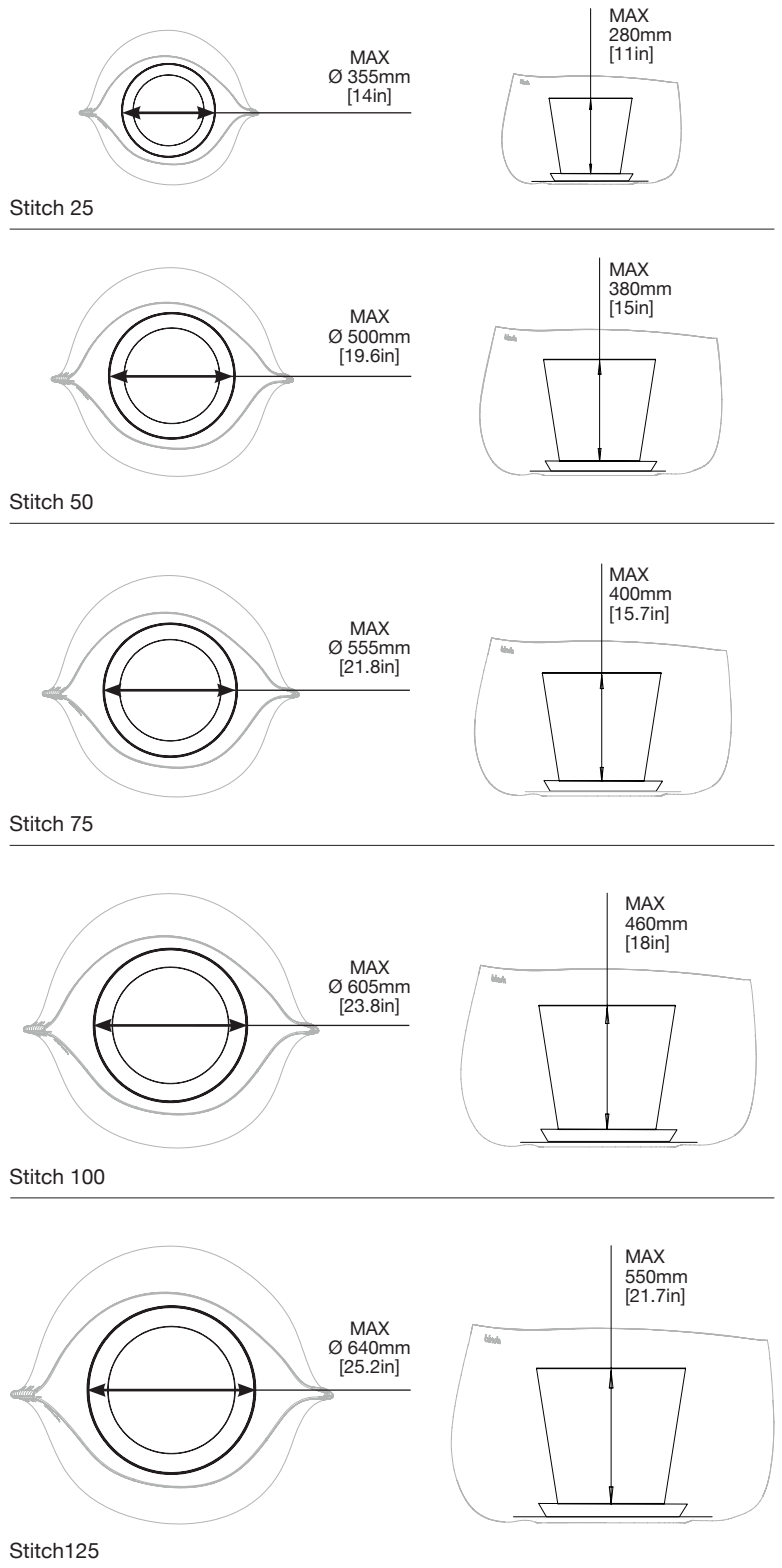

## Water Sealing Accessories

Stitch Planters come with waterproof plugs already installed.

### For Indoor Use

Leave plugs as they are.

### For Outdoor Use

Unscrew the hex screws with a shifting spanner or wrench to disengage. Remove both the washer and screw, keep parts if intending to use indoors in the future.

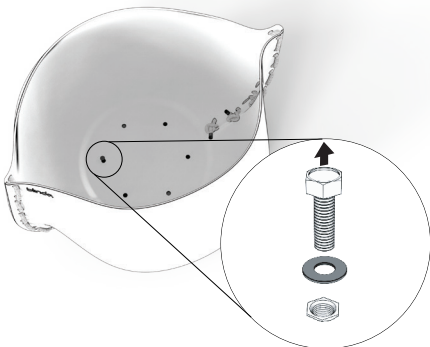

# Stitch Planter Rope Assembly

**WARNING CHOKING HAZARD.** Keep away from children.

## Included items



## Assembly Steps

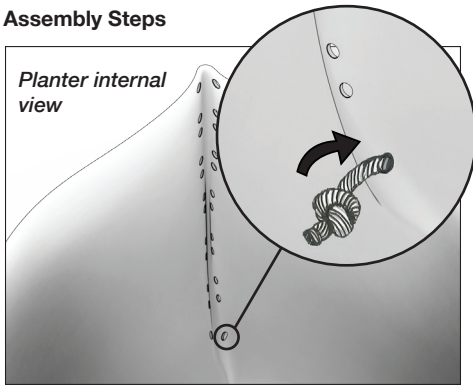

1. Locate the last hole on one side of the planter. Tie a simple knot on the end of one of the ropes and thread unknotted end through hole.

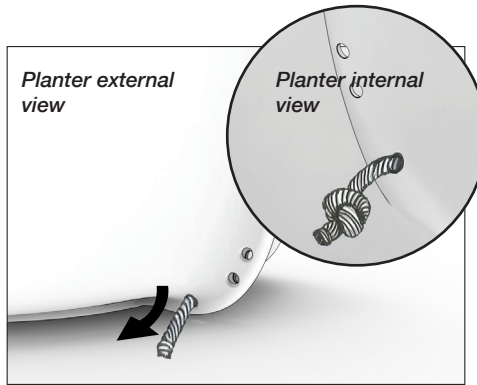

2. Pull the unknotted end of the rope all the way through the hole until the knot hits the end as shown.

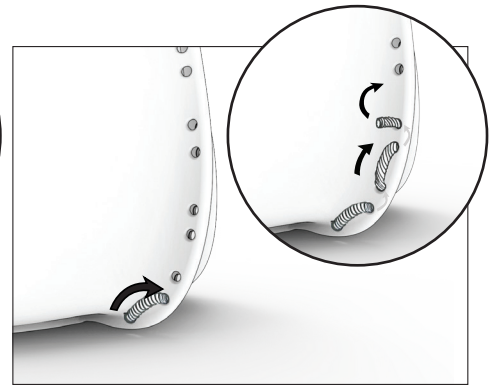

3. Thread the rope through the next hole above and pull towards the internal of the planter. Thread the rope in alternating in-out pattern as illustrated.  
CAUTION: Do not over tighten, but ensure sufficient tension for each loop.

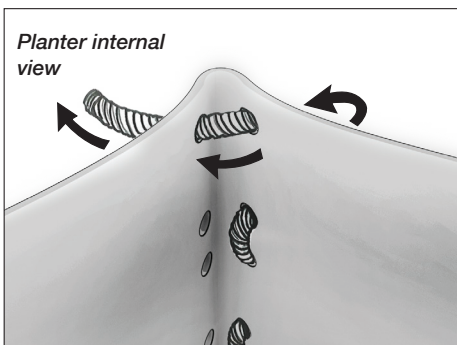

4. When reaching the top hole, thread the rope through the other line of holes on adjacent side. Continue to thread the rope until reaching the bottom of the planter.

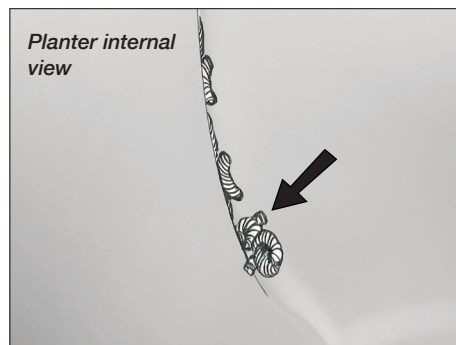

5. Pull the end of the rope tight before finishing with a simple knot.

Repeat steps for the other side of the planter.

