

DVDO



DVDO-Splitter-14-CAT

4K 1x4 HDMI Splitter with CAT Outputs

User Manual

Version v1.0

Thank you for purchasing DVDO-Splitter-14-CAT

For optimum performance and safety, please read these instructions carefully before connecting, operating or adjusting this product. Please keep this manual for future reference.

Surge protection device recommended

DVDO-Splitter-14-CAT contains sensitive electrical components that may be damaged by electrical spikes, surges, electric shock, lightning strikes, etc. Use of surge protection systems is highly recommended in order to protect and extend the life of your equipment.

Table of Contents

1. Introduction.	1
2. Features.....	1
3. Package Contents.	1
4. Specifications.	2
5. Operation Controls and Functions.	3
5.1 Transmitter.....	3
5.2 CAT Receiver.	5
5.3 IR Pin Definition.....	6
6. EDID Mode.	7
7. ASCII Commands.....	8
8. Application Example.	11

1. Introduction

DVDO-Splitter-14-CAT is an 18Gbps HDMI 1x4 splitter that can distribute 1 HDMI source signal to any 4 display devices, with video resolutions up to 4K2K@50/60Hz 4:4:4. It is designed with 1 HDMI loop output and 4 CAT outputs. The HDMI signal transmission distance can be extended up to 115ft/35m at the resolution of 4K2K@60Hz, or 164ft/50m at 4K2K@30Hz, or 197ft/60m at 1080p@60Hz via a single CAT6/6a/7 cable. DVDO-Splitter-14-CAT supports one-way IR control signal pass-through, audio extract function and advanced EDID management.

2. Features

- ☆ HDMI 2.0b, HDCP 2.2 and HDCP 1.x compliant
- ☆ Support 18Gbps video bandwidth
- ☆ Support video resolution up to 4K2K@50/60Hz 4:4:4
- ☆ Support HDR, HDR10+, HLG and Dolby vision
- ☆ Support up to 7.1CH HD audio pass-through
- ☆ Support digital and analog audio de-embedded output
- ☆ Extend the signal transmission distance up to 35 meters at the resolution of 4K2K@60Hz, 50 meters at 4K2K@30Hz, 60 meters at 1080p@60Hz via a single CAT6/6a/7 cable
- ☆ Support 1 HDMI input, 1 HDMI loop output and 4 CAT outputs.
- ☆ Support one-way IR control signal pass-through
- ☆ Advanced EDID management
- ☆ Support one-way POC function (only from transmitter to receiver)
- ☆ Compact design for easy and flexible installation

3. Package Contents

- ① 1 x 18Gbps 1x4 HDMI Splitter over 60m CAT
- ② 4 x CAT Receivers
- ③ 1 x IR Blaster Cable (1.5m)
- ④ 4 x 20K~60KHz IR Receiver Cable (1.5m)
- ⑤ 1 x 12V/2.5A DC Locking Power Adapter
- ⑥ 1 x User Manual

4. Specifications

Technical	
HDMI Compliance	HDMI 2.0b
HDCP Compliance	HDCP 2.2/1.x
Video Bandwidth	594MHz/18Gbps
Video Resolution	Up to 4k2k@50/60Hz 4:4:4
Color Depth	8-bit,10-bit,12-bit(1080p@60Hz) 8-bit (4K2K@60Hz YUV4:4:4) 8-bit,10-bit,12-bit(4K2K@60Hz YCbCr 4:2:2/4:2:0)
Color Space	RGB, YCbCr 4:4:4 / 4:2:2. YUV 4:2:0
HDR	Support HDR10, HDR10+, HLG, Dolby vision
HDMI Audio Formats	LPCM 2.0/2.1/5.1/6.1/7.1, Dolby Digital, Dolby TrueHD, Dolby Digital Plus(DD+), DTS-ES, DTS HD Master, DTS HD-HRA, DTS-X
Coaxial Audio Formats	PCM2.0, Dolby Digital / Plus, DTS 2.0/5.1
Analog Audio Formats	PCM 2.0CH
ESD Protection	Human body model—±8kV (Air-gap discharge) & ±4kV (Contact discharge)
Connection	
Input	1xHDMI Type A (19-pin female)
Output	1xHDMI Type A (19-pin female) 4x CAT OUT [RJ45, 8-pin female] 1x Coaxial Audio OUT [RCA] 1x L/R Audio OUT [3.5mm Stereo Mini-jack]
Control	1xSERVICE (Micro USB, Update port) 1x EDID DIAL switch [5-pin] 1x IR OUT [3.5mm Stereo Mini-jack]

Mechanical	
Housing	Metal Enclosure
Silkscreen Color	Black
Dimensions	Transmitter: 210mm (W) × 100mm (D) × 25mm (H) Receiver: 88mm (W) × 61mm (D) × 18mm (H)
Weight	Transmitter: 617g Receiver:155g
Power Supply	Input: AC100 - 240V 50/60Hz, Output: DC 12V/2.5A (US/EU standards, CE/FCC/UL certified)
Power Consumption	14W
Operation Temperature	0°C ~ 40°C / 32°F ~ 104°F
Storage Temperature	-20°C ~ 60°C / -4°F ~ 140°F
Relative Humidity	20~90% RH (non-condensing)

5. Operation Controls and Functions

5.1 Transmitter Panel

Front Panel

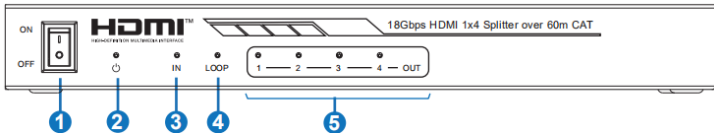

No.	Name	Function Description
1	POWER switch	Press this switch to power on/off the device.
2	POWER LED	When the device is powered on, the red power LED will be on.
3	IN LED	When the HDMI IN port connects an active source device, the green LED will be on.
4	LOOP LED	When the HDMI LOOP OUT port connects an active display device, the green LED will be on.
5	OUT LED (1~4)	When the CAT OUTPUT port connects the CAT IN port of CAT receiver, the corresponding green OUT LED will be on.

Rear Panel

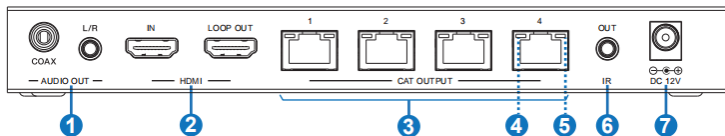

No.	Name	Function Description
1	AUDIO OUT (COAX, L/R)	Coaxial/analog audio output port, connect to amplifier or speaker.
2	HDMI port	IN: HDMI input port, connect to HDMI source device such as DVD or set-top box with an HDMI cable.
		LOOP OUT: HDMI loop output port, connect to the HDMI display device such as TV or Monitor with an HDMI cable.
3	CAT OUTPUT port (1~4)	Connect to the CAT IN port of the CAT receiver with a CAT cable.
4	Link Signal Indicator lamp (Green)	<ul style="list-style-type: none"> ▪ Illuminate: Transmitter and receiver are connected. ▪ Dark: Transmitter and receiver are not connected.
5	Data Signal Indicator lamp (Orange)	<ul style="list-style-type: none"> ▪ Illuminating: HDMI signal with HDCP. ▪ Flashing: HDMI signal without HDCP. ▪ Dark: No HDMI signal.
6	IR OUT	Connect the IR Blaster cable to transmit IR signal from the CAT receiver.
7	DC 12V	Plug the DC 12V power supply into the unit and connect the adaptor to an AC outlet. (Note: The transmitter can power the receiver via a CAT cable.)

Side Panel

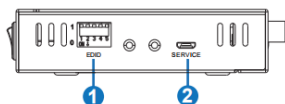

No.	Name	Function Description
1	EDID DIAL switch	Used to set EDID mode. Please refer to Section "6. EDID Mode" for details.
2	SERVICE port	Used for firmware update or serial port command control. Please refer to "7. ASCII Commands".

5.2 CAT Receiver

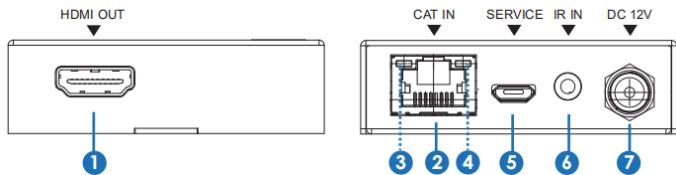

No.	Name	Function Description
1	HDMI OUT	HDMI output port, connect to HDMI display device such as TV or Projector with an HDMI cable.
2	CAT IN	Connect to the CAT OUTPUT port on the transmitter with a CAT cable.
3	Power Indicator Lamp (Green)	When the receiver is powered on, the power indicator lamp will be on.
4	Data signal Indicator Lamp (Orange)	<ul style="list-style-type: none"> ▪ Illuminating: HDMI signal with HDCP. ▪ Flashing: HDMI signal without HDCP. ▪ Dark: No HDMI signal.
5	SERVICE port	Used for firmware update.
6	IR IN	Connect to the IR Receiver cable. The IR signal will send to the IR OUT port of the transmitter.
7	DC 12V	<p>Plug DC 12V/1A power supply into the unit and connect the adapter to an AC outlet.</p> <p>(Note: The CAT receiver also can be powered by the transmitter via a CAT cable.)</p>

5.3 IR Pin Definition



IR RECEIVER



IR BLASTER

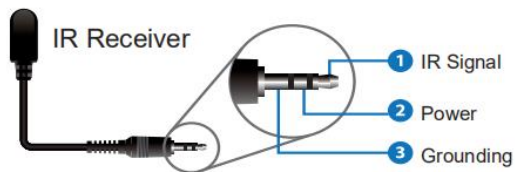
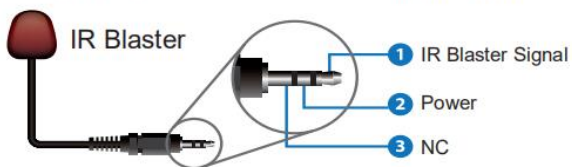

Note: When the angle between the IR receiver and the remote control is $\pm 45^\circ$, the transmission distance is 0-5 meters; when the angle between the IR receiver and the remote control is $\pm 90^\circ$, the transmission distance is 0-8 meters.

6. EDID Mode

Below is the list of EDID settings for DVDO-Splitter-14-CAT:

EDID Mode	EDID Description
11111	1080p, Stereo Audio 2.0
11110	1080p, Dolby/DTS 5.1
11101	1080p, HD Audio 7.1
11100	1080i, Stereo Audio 2.0
11011	1080i, Dolby/DTS 5.1
11010	1080i, HD Audio 7.1
11001	1080p 3D, Stereo Audio 2.0
11000	1080p 3D, Dolby/DTS 5.1
10111	1080p 3D, HD Audio 7.1
10110	4K2K30Hz_444, Stereo Audio 2.0
10101	4K2K30Hz_444, Dolby/DTS 5.1
10100	4K2K30Hz_444, HD Audio 7.1
10011	4K2K60Hz_420, Stereo Audio 2.0
10010	4K2K60Hz_420, Dolby/DTS 5.1
10001	4K2K60Hz_420, HD Audio 7.1
10000	4K2K60Hz_444, Stereo Audio 2.0
01111	4K2K60Hz_444, Dolby/DTS 5.1
01110	4K2K60Hz_444, HD Audio 7.1
01101	4K2K60Hz_444, Stereo Audio 2.0 HDR
01100	4K2K60Hz_444, Dolby/DTS 5.1 HDR
01011	4K2K60Hz_444, HD Audio 7.1HDR
01010	COPY_FROM_LOOP OUT
01001	COPY_FROM_CAT OUT1
01000	COPY_FROM_CAT OUT2
00111	COPY_FROM_CAT OUT3
00110	COPY_FROM_CAT OUT4
00101	1080p, Stereo Audio 2.0
00100	1080p, Stereo Audio 2.0
00011	1080p, Stereo Audio 2.0
00010	1080p, Stereo Audio 2.0
00001	1080p, Stereo Audio 2.0
00000	PC control mode

7. ASCII Commands

DVDO-Splitter-14-CAT also supports ASCII command control. Connect the SERVICE port of the unit to a PC with a USB cable. Then, open a Serial Command tool on a PC to send ASCII commands to control the unit. Below is the list of ASCII commands for DVDO-Splitter-14-CAT:

ASCII Commands				
Serial port protocol. Baud rate: 115200, Data bits: 8bit, Stop bits:1, Check bit: 0				
x - Parameter 1 y - Parameter 2 ! - Delimiter				
Command Code	Function Description	Example	Feedback	Default Setting
Power				
s power z!	Power on/off the device,z=0~1 (z=0 power off, z=1 power on)	s power 1!	Power on System Initializing... Initialization Finished! FW version x.xx.xx	power on
r power!	Get current power state	r power!	power on/power off	
s reboot!	Reboot the device	s reboot!	reboot	
System Setup				
help!	List all commands	help!		
r type!	Get device model	r type!		
r status!	Get device current status	r status!	Get the unit all status power, in/out connection, edid mode	
r fw version!	Get Firmware version	r fw version!	MCU BOOT: Vx.xx.xx MCU APP: Vx.xx.xx	
r link in!	Get the connection status of the input port	r link in!	HDMI IN: connect	
r link out y!	Get the connection status of the y output port, y=0~4(0=all, 1~4=CAT 1~4)	r link out 1!	CAT OUT1: connect	
r link loop out y!	Get the connection status of the y loop output port, y=1	r link loop out 1!	HDMI LOOP OUT: connect	
s reset!	Reset to factory defaults	s reset!	Reset to factory defaults System Initializing... Initialization Finished! FW version x.xx.xx	

Command Code	Function Description	Example	Feedback	Default Setting
Output Setting				
s hdmi stream z!	Set hdmi loop output stream on/off z=0~1(0:disable,1:enable)	s hdmi stream 1 !	Enable hdmi loop out stream Disable hdmi loop out stream	enable
s cat y stream z!	Set cat output y stream on/off, y=0~4(0=all) z=0~1 (0:disable,1:enable)	s cat 1 stream 1 ! s cat 0 stream 1 !	Enable cat output 1 stream Disable cat output 1 stream Enable cat all outputs stream Disable cat all outputs stream	enable
r hdmi stream!	Get hdmi loop out stream status	r hdmi stream!	Enable hdmi loop output stream	
r cat y stream!	Get cat output y stream status, y=0~4(0=all)	r cat 1 stream!	Enable cat output 1 stream	
s hdmi hdcp z!	set hdmi loop output port hdcp status	s hdmi hdcp 1!	hdmi loop out hdcp on	all hdmi out hdcp active
r hdmi hdcp!	Get HDCP status of loop out	r hdmi hdcp!	hdmi loop out hdcp on	
s cat y hdcp z!	set cat output y port hdcp status y=0~2(0=all) z=0~1 (1=on,0=off)	s cat 1 hdcp 1!	cat out 1 hdcp on	all cat out hdcp active
r cat y hdcp!	Get HDCP status of cat out y, y=0~2(0=all)	r cat 1 hdcp!	cat out 1 hdcp on	
s cat y dsc mode z!	set cat output y port dsc mode status y=0~4(0=all) z=1~3 (1=Cat cable distance normal Mode, 2= Cat cable distance 35M Mode,3= Cat cable distance 70M Mode)	s cat 1 dsc mode 2!	cat out 1 dsc mode 2	Cat cable distance 35M Mode(35M)
r cat y dsc mode!	Get dsc mode of cat out y, y=0~4(0=all)	r cat 1 dsc mode!	cat out 1 dsc mode 2	
s audio mute 1!	set audio output port mute status (1-mute, 0-unmute)	s audio mute 1!	s audio mute 1	s audio unmute (0)
r audio mute!	Get audio output mute status	r audio mute!	audio mute 1	

Command Code	Function Description	Example	Feedback	Default Setting
EDID Setting				
s edid in from z!	Set input EDID from default EDID z, z=1~26 1. 1080p,Stereo Audio 2.0 2. 1080p,Dolby/DTS 5.1 3. 1080p,HD Audio 7.1 4. 1080i,Stereo Audio 2.0 5. 1080i,Dolby/DTS 5.1 6. 1080i,HD Audio 7.1 7. 3D,Stereo Audio 2.0 8. 3D,Dolby/DTS 5.1 9. 3D,HD Audio 7.1 10. 4K2K30_444, Stereo Audio 2.0 11. 4K2K30_444, Dolby/DTS 5.1 12. 4K2K30_444,HD Audio 7.1 13. 4K2K60_420, Stereo Audio 2.0 14. 4K2K60_420, Dolby/DTS 5.1 15. 4K2K60_420,HD Audio 7.1 16. 4K2K60_444, Stereo Audio 2.0 17. 4K2K60_444, Dolby/DTS 5.1 18. 4K2K60_444,HD Audio 7.1 19. 4K2K60_444, Stereo Audio 2.0 HDR 20. 4K2K60_444, Dolby/DTS 5.1 HDR 21. 4K2K60_444, HD Audio 7.1 HDR 22. copy from hdmi loop out 23. copy from cat output 1 24. copy from cat output 2 25. copy from cat output 3 26. copy from cat output 4	s edid in from 1!	input EDID:1080p, Stereo Audio 2.0 Please toggle EDID dip switch to 00000!	1080p,Stereo Audio 2.0
r edid in!	Get EDID status of the input	r edid in!	input EDID: 4K2K60_444,Stereo Audio 2.0	
r edid in data!	Get the EDID data of the hdmi input	r edid in data!	EDID data : 00 FF FF FF FF FF FF FF 00	

8. Application Example

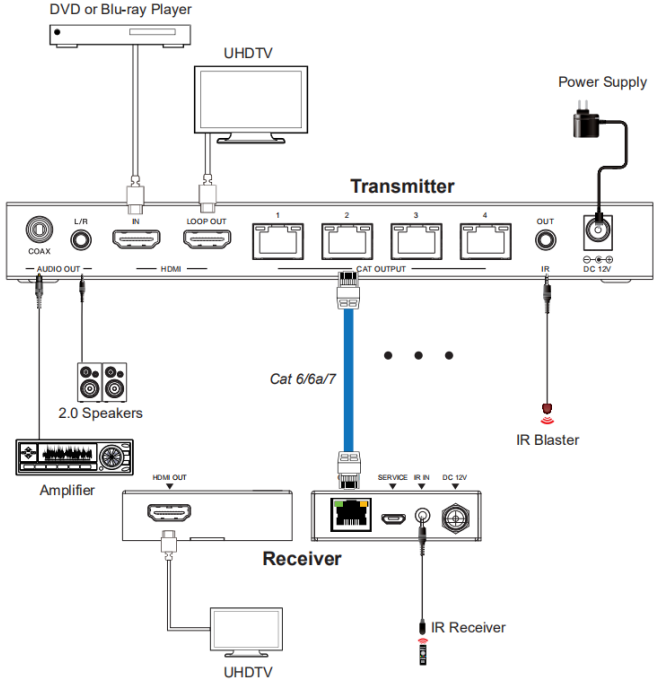

The terms HDMI and HDMI High-Definition Multimedia interface, and the HDMI Logo are trademarks or registered trademarks of HDMI Licensing LLC in the United States and other countries.

DVDO

Follow us

