

**RUBICON**  
LIGHTING

**LIGHT FRAME 40**  
Recessed





**Features:**

- Constant Current
- Minimum Lumen Maintenance: 54 000h (L90B10)

<b>Power Supply:</b>	207 - 253V AC   50 - 60Hz				
<b>Operating Temperature Range:</b> (Ta - Ambient)	- 20°C to 35°C				
<b>Dimming:</b>	Dali_1-10V (On Request)				
<b>Colour Rendering Index:</b>	CRI 80+				
<b>Colour Consistency:</b>	3-Step MacAdam				
<b>Colour Temperature:</b> (Kelvin / CCT)	<input checked="" type="radio"/> 3000K <input type="radio"/> 4000K <input checked="" type="radio"/> 3500K				
<b>Beam Angle:</b>	110°				
<b>Installation Type:</b>	Recessed Mount				
<b>Ingress Protection:</b>	IP20				
<b>IK Rating:</b>	IP08				
<b>Luminaire Colour:</b>	<input type="radio"/> White <input checked="" type="radio"/> Black <input type="radio"/> Alu Anodised <input type="radio"/> Custom Colours Available (On Request)				
<b>Material:</b>	Housing - Powder Coated Extruded Aluminium Diffuser - Opal PMMA				
	<b>Dimensions</b>	<b>Wattage (System)</b>	<b>CRI</b>	<b>Kelvin</b>	<b>Luminous Flux (Effective)</b>
	600mm x 54mm x 40mm	16W	80+	4000K	2920Lm*
	600mm x 54mm x 40mm	24W	80+	4000K	4100Lm*
	880mm x 54mm x 40mm	24W	80+	4000K	4380Lm*
	880mm x 54mm x 40mm	36W	80+	4000K	6150Lm*
	1160mm x 54mm x 40mm	32W	80+	4000K	5840Lm*
	1160mm x 54mm x 40mm	48W	80+	4000K	8200Lm*
	1440mm x 54mm x 40mm	40W	80+	4000K	7300Lm*
	1440mm x 54mm x 40mm	56W	80+	4000K	10250Lm*

\*E & O.E (Errors And Omissions Excepted)

\*Due to the rapid development in LED technology the performance values, power consumption and lumen output levels stated above are subject to change without prior notice.

\*All lumen outputs stated above are based a nominal output that included a 10% light loss, this can vary depending on the optic used.

**Light Distribution:**

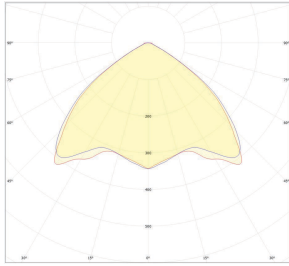

110°

**Dimensions:**

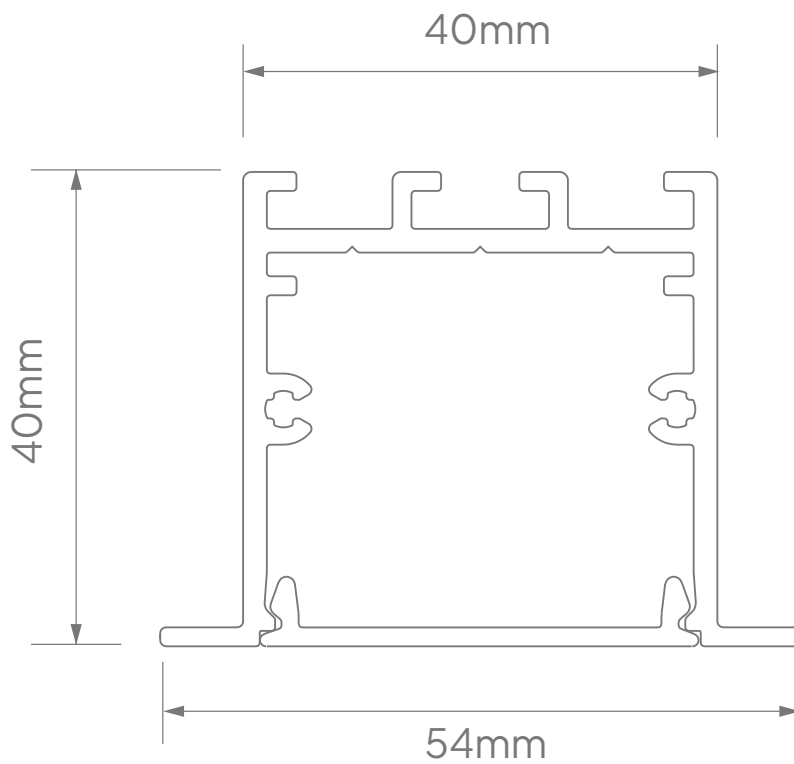

\*E & O.E (Errors And Omissions Excepted)

\*Due to the rapid development in LED technology the performance values, power consumption and lumen output levels stated above are subject to change without prior notice.

\*All lumen outputs stated above are based a nominal output that included a 10% light loss, this can vary depending on the optic used.

# Contact

## Cape Town

1B Hansen Close,  
Richmond Park,  
Cape Town  
T. +27 21 555 0570

## Durban

Unit L, Nandi Park,  
34 Brickworks Way  
Briardene  
T. +27 31 001 2964

## Namibia – Windhoek

Unit 2, Tesoro Building,  
31 TV More Street  
Windhoek  
T. +264 61 40 0339

## Johannesburg

17 Galaxy Road,  
Unit 5A Galaxy Park,  
Linbro Park  
T. +27 11 262 5179

## Port Elizabeth

216 Main Road,  
Walmer  
Port Elizabeth  
T. +27 41 451 4359