

DE Montageanleitung**EN** Mounting instruction**ES** Instrucciones de instalación**FR** Instructions d'installation**IT** Istruzioni per l'installazione**NL** Montagehandleiding**CS** Návod k instalaci**PL** Instrukcja montażu**RU** Инструкция по монтажу

59541 010101	59541 020101
59541 070101	59541 030101
59541 170101	59541 040101
	59541 050101
	59541 120101
	59541 130101

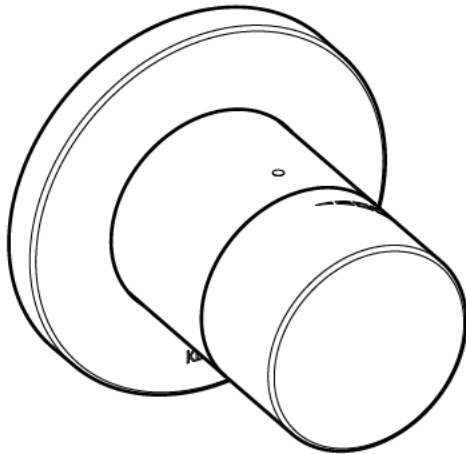

59541 010102	59541 020102
59541 070102	59541 030102
59541 170102	59541 040102
	59541 050102
	59541 120102
	59541 130102

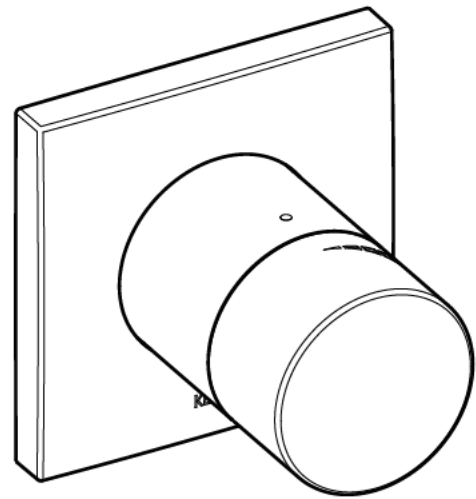
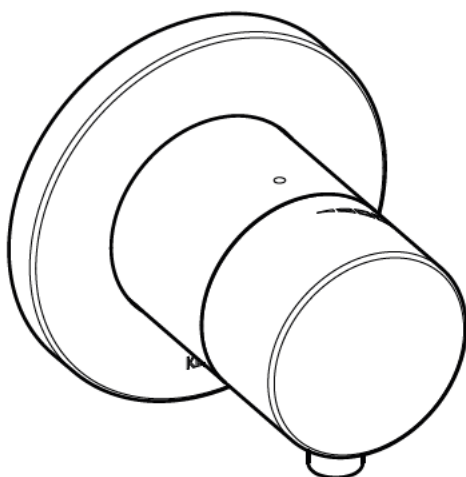

59541 011101	59541 021101
59541 071101	59541 031101
59541 171101	59541 041101
	59541 051101
	59541 121101
	59541 131101

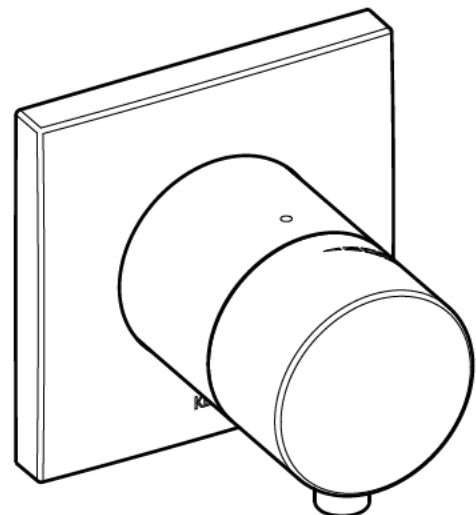

59541 011102	59541 021102
59541 071102	59541 031102
59541 171102	59541 041102
	59541 051102
	59541 121102
	59541 131102

DE Einbaumaße

FR Dimensions de montage

CS Montážní rozměry

EN Mounting dimensions

IT Dimensioni di montaggio

PL Wymiary montażowe

ES Dimensiones de montaje

NL Montageafmetingen



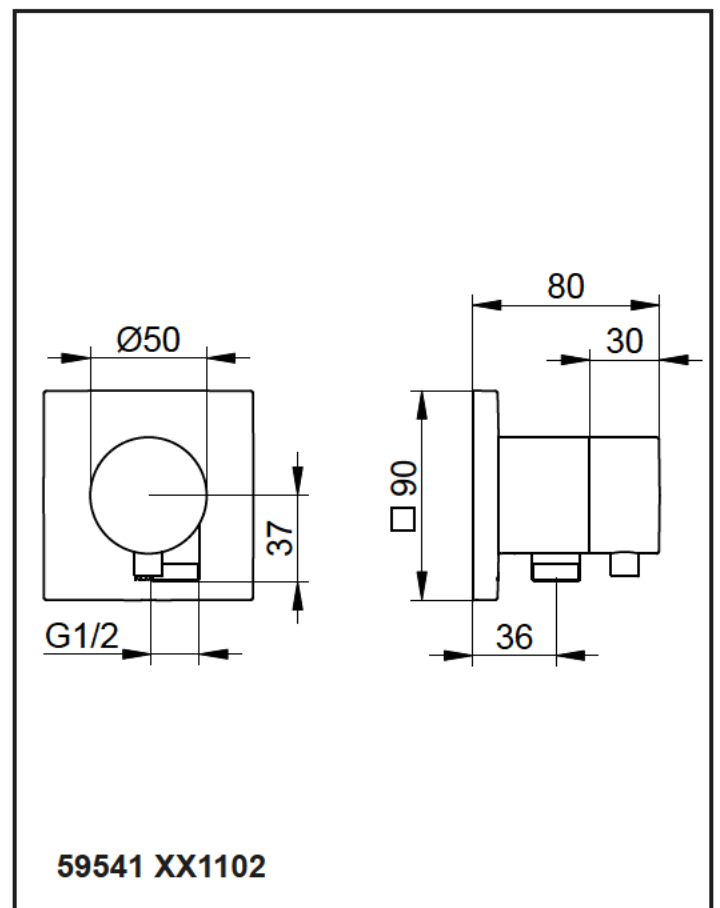
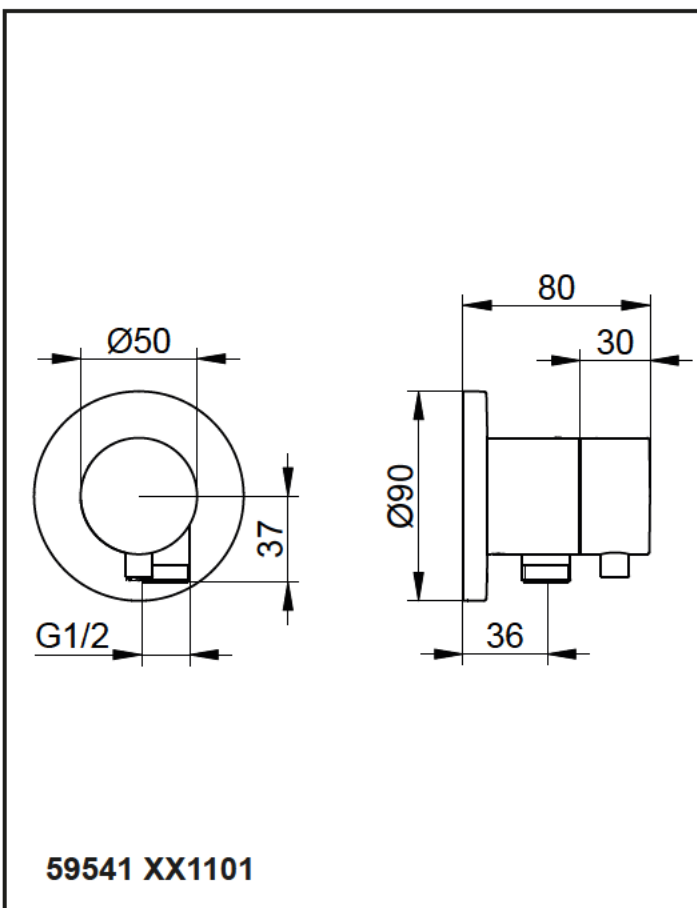
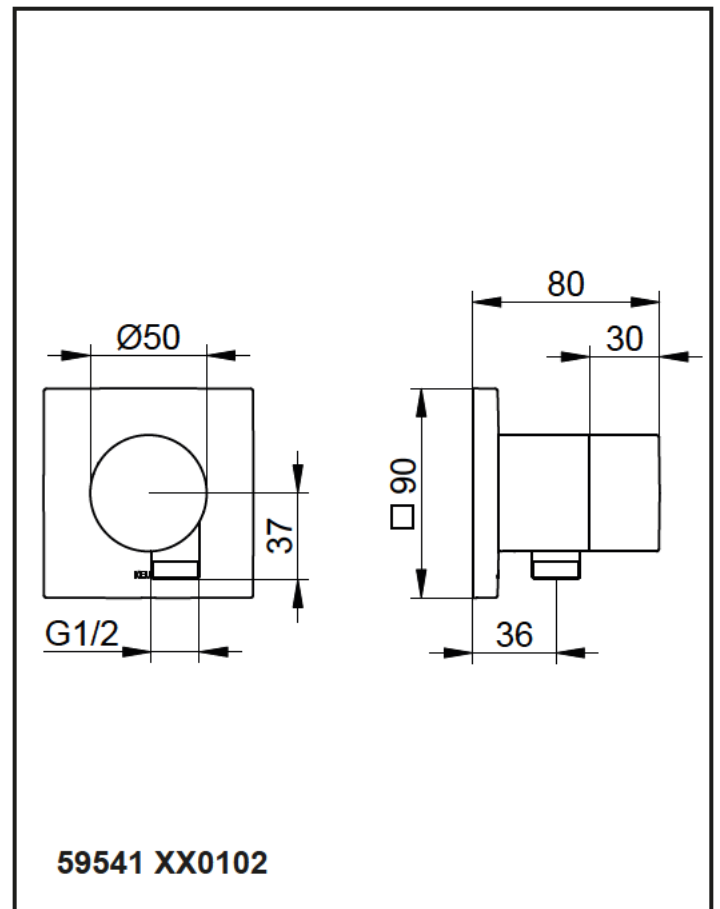
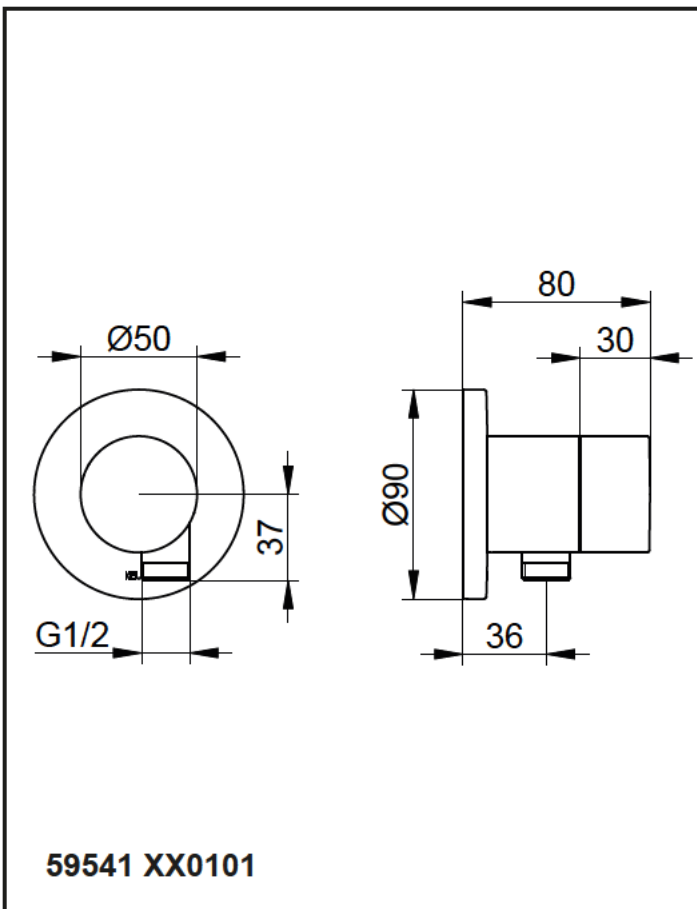







RU Установочные размеры













 Diese Anleitung ist für den Installateur zur Montage sowie für den Nutzer zur Bedienung und Wartung des Produktes. Bitte nach der Installation an den Nutzer zur Verwahrung weitergeben.

 These instructions are for both the installer for installation and the user for operation and maintenance of the product. After installation, please hand them over to the user to keep.

Symbole und Bedeutung

-  **Achtung!** Warnung vor Personen- oder Sachschaden.
-  Hinweis, Tipp oder Verweis
-  Korrekte Montage/Funktionsprüfung
-  Falsche Montage
-  Montagedetail beachten
-  Kaltwasser  Warmwasser
-  Wasserfluss  Kein Wasserfluss
-  Optional/Zubehör

Symbols and explanations

-  **Attention!** Warning against bodily injury or damage to property.
-  Note, tip or reference
-  Correct installation/test of functionality
-  Incorrect installation
-  Observe installation details
-  Cold water  Hot water
-  Water flow  No water flow
-  Optional/accessories

Technische Daten

Durchfluss bei 3 bar Fließdruck: ca. 12 l/min

Technical specifications

Flow at 3 bar pressure: approx. 12 l/min

Einbaumaße, siehe Seite 2

Installation dimensions, refer to page 2

Installation, siehe ab Bild 1 auf Seite 8

 Nur neutral vernetzendes Silikon verwenden.

Installation, refer to picture 1 on page 8

 Use only neutrally netting silicone.

Bedienung, siehe Bild 9 auf Seite 10

Operation, refer to picture 9 on page 10

Wartung, siehe Bild 10 auf Seite 10

Montage in umgekehrter Reihenfolge.
– Anzugsmoment Kartuschenmutter: 20-30 Nm

Servicing, refer to picture 10 on page 10

Assemble in reverse order.
– Cartridge nut torque: 20-30 Nm

Ersatzteile mit Bestellnummern, siehe Seite 11

For spare parts with order numbers, refer to page 11

 Hinweise zur Gewährleistung und Pflege sind dem beiliegendem **Pflege- und Garantiepass** zu entnehmen.

 For warranty and care information please refer to the attached **warranty and care instructions**.

 Este manual está dirigido al instalador para el montaje, así como al usuario para el manejo y mantenimiento del producto. Por favor, después de la instalación, este manual se debe entregar al usuario para que lo conserve.

Símbolos y significado

 ¡Atención! Advertencia de daños personales o materiales.

 Indicación, consejo o referencia

 Montaje/comprobación de funcionamiento correctos

 Montaje erróneo

 Observar el detalle de montaje

 Agua fría

 Agua caliente

 Flujo de agua

 Ningún flujo de agua

 Opcional/Accesorios

Datos técnicos

Paso con una presión de caudal de 3 bares:
aprox. 12 l/min.

Medidas de montaje, véase página 2

Instalación, véase imagen 1 en la página 8

 Utilizar exclusivamente silicona de reticulación neutra.

Manejo, véase imagen 9 en la página 10

Mantenimiento, véase imagen 10 en la página 10

El montaje se efectúa en el orden inverso.
– Par de apriete de la tuerca de fijación del cartucho: 20-30 Nm

Piezas de recambio con números de pedido, véase página 11

 En el pasaporte de mantenimiento y garantía adjunto encontrará indicaciones sobre la **garantía y el mantenimiento.**

 Ces instructions sont destinées à l'installateur, pour effectuer le montage, et pour l'utilisateur, pour utiliser le produit et procéder à sa maintenance. Après l'installation, veuillez remettre ces instructions à l'utilisateur pour qu'il les conserve.

Symboles et leur signification

 **Attention !** Mise en garde contre les dégâts de personnes et les dégâts matériels.

 Remarque, conseil ou renvoi

 Montage correct/contrôle fonctionnel

 Montage incorrect

 Respecter le détail de montage

 Eau froide

 Eau chaude

 Débit d'eau

 Pas de débit d'eau

 Option/accessoires

Caractéristiques techniques

Débit à une pression d'écoulement de 3 bar :
env. 12 l/mn

Cotes d'encombrement, voir page 2

Installation, voir figure 1 à la page 8

 N'utiliser que du silicone à réticulation neutre.

Utilisation, voir figure 9 à la page 10

Maintenance, voir figure 10, page 10

Le montage s'effectue dans l'ordre inverse de la dépose.











– Couple de serrage écrou de cartouche :
20-30 Nm

Pièces de rechange avec numéros de commande, voir page 11

 Les consignes relatives à la garantie et à l'entretien figurent sur la **carte d'entretien et de garantie** jointe.

 Il presente manuale è indirizzato agli installatori per il montaggio nonché agli utilizzatori per l'uso e la manutenzione del prodotto. Consegnarlo all'utilizzatore dopo l'installazione affinché lo custodisca.

Simboli e significato

-  **Attenzione!** Pericolo di lesioni o danni materiali.
-  Avvertenza, consiglio o rimando
-  Montaggio corretto/verifica del funzionamento
-  Montaggio errato
-  Prestare attenzione al dettaglio di montaggio
-  Acqua fredda  Acqua calda
-  Flusso d'acqua  Nessun flusso d'acqua
-  Opzionale/accessorio

Dati tecnici

Portata con pressione di flusso di 3 bar:
circa 12 l/min

Ingombro, vedi pagina 2

Installazione, vedi dalla figura 1 a pagina 8

 Utilizzare solo silicone neutro.

Uso, vedi figura 9 a pagina 10

Manutenzione, vedi figura 10 a pagina 10

Eseguire il montaggio in ordine inverso.
– Coppia del dado della cartuccia: 20-30 Nm

Ricambi con numero d'ordine, vedi pagina 11

 Indicazioni relative alla garanzia e al trattamento vanno desunte dalla **scheda allegata**.

 Deze handleiding is bestemd voor zowel de installateur voor de montage alsook voor de gebruiker voor het gebruik en het onderhoud van het product. Gelieve na de installatie door te geven aan de gebruiker om te bewaren.

Symbolen en betekenis

-  **Opgepast!** Gevaar voor letsel of schade.
-  Opmerking, tip of referentie
-  Correcte montage/werkingstest
-  Verkeerde montage
-  Montagedetails in acht nemen
-  Koud water  Heet water
-  Waterstroom  Geen waterstroom
-  Optioneel/toebehoren

Technische gegevens

Doorstroming bij 3 bar stromingsdruk:
ca. 12 l/min

Inbouwafmetingen, zie pagina 2

Installatie, zie vanaf afbeelding 1 op pagina 8

 Uitsluitend neutraal vernette siliconen gebruiken.

Gebruik, zie afbeelding 9 op pagina 10

Onderhoud, zie afbeelding 10 op pagina 10

Montage in omgekeerde volgorde.
– Aandraaimoment moer voor cartouche: 20-30 Nm

Wisselstukken met bestelnummers, zie pagina 11

 Instructies voor de waarborg en het onderhoud vindt u in de meegeleverde **Onderhouds- en garantiokaart**.

 Tento návod slouží instalatérům při montáži a uživatelům při obsluze a údržbě produktu. Po nainstalování ho předejte uživateli, aby si ho mohl uschovat.

Symbole a význam

-  **Pozor!** Výstraha před zraněním a věcnými škodami.
-  Upozornění, tip nebo odkaz
-  Správná montáž / kontrola funkčnosti
-  Nesprávná montáž
-  Při montáži dbejte na tento detail
-  Studená voda  Teplá voda
-  Průtok vody  Žádný průtok vody
-  Volitelná výbava / příslušenství

Technické údaje

Průtok při průtokovém tlaku 3 bary: cca. 12 l/min

Montážní rozměry viz strana 2**Instalace viz obrázek 1 na straně 8**

 Používejte pouze neutrální silikon.

Obsluha viz obrázek 9 na straně 10**Údržba viz obrázek 10 na straně 10**











Montáž probíhá v obráceném pořadí.
– Utahovací moment matice kartuše: 20-30 Nm

Náhradní díly s objednáacími čísly viz strany 11

 Pokyny týkající se záruky a péče najdete v přiloženém **Návodu k údržbě a záručním listu**.

 Instrukcja przeznaczona jest dla instalatora, zapewniając pomoc w zakresie montażu oraz dla użytkownika, informując go o sposobie obsługi i konserwacji produktu. Po instalacji należy przekazać instrukcję użytkownikowi, aby ją u siebie przechowywał.

Symbole i znaczenie

-  **Uwaga!** Ostrzeżenie przed uszkodzami osobowymi i materialnymi.
-  Informacja, dobra rada lub odsylacz
-  Właściwy montaż / kontrola funkcjonowania
-  Niewłaściwy montaż
-  Należy stosować się do danych, dotyczących montażu
-  Woda zimna  Woda gorąca
-  Strumień wody  Brak strumienia wody
-  Opcje / Osprzęt

Dane techniczne

Przepływ w przypadku ciśnienia hydraulicznego 3 bar: około 12 l/min

Wymiary zabudowy, patrz strona 2**Instalacja, patrz rys. 1 na stronie 8**

 Należy wykorzystywać wyłącznie silikon, ulegający naturalnemu usieciowaniu.

Obsługa, patrz rys. 9 na stronie 10**Konserwacja, patrz rys. 10 na stronie 10**

Montaż w odwrotnej kolejności.
– Moment obrotowy dokręcenia nakrętki głowicy: 20-30 Nm

Części zamienne z numerami zamówienia, patrz strona 11

 Informacje dotyczące gwarancji dostępne są w dołączonej **karcie pielęgnacyjno-gwarancyjnej**.

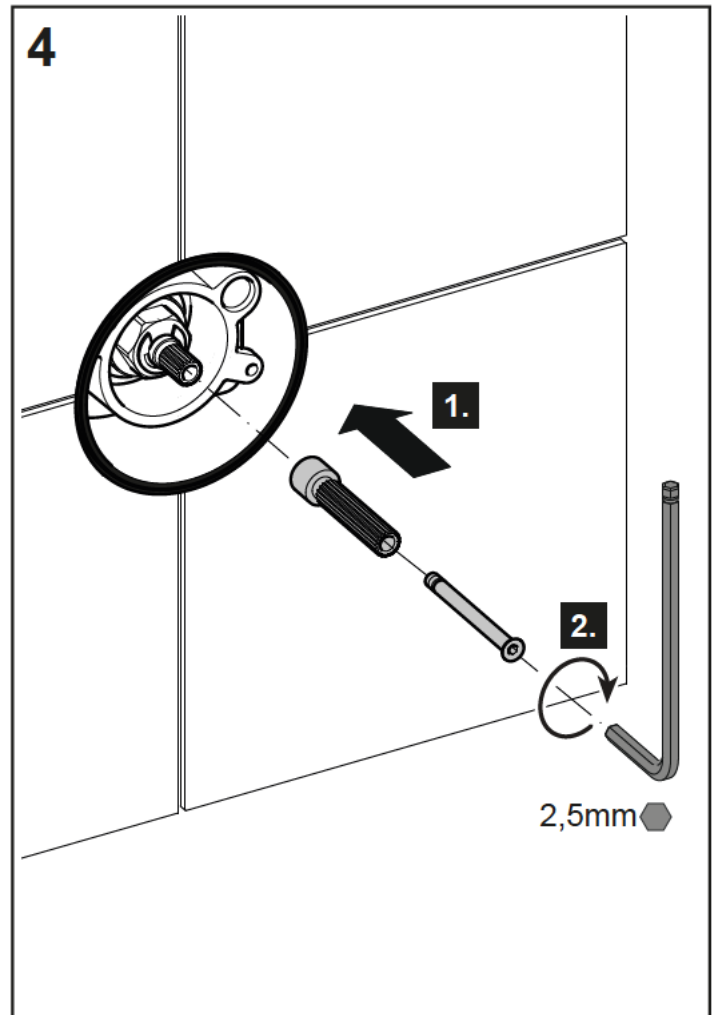
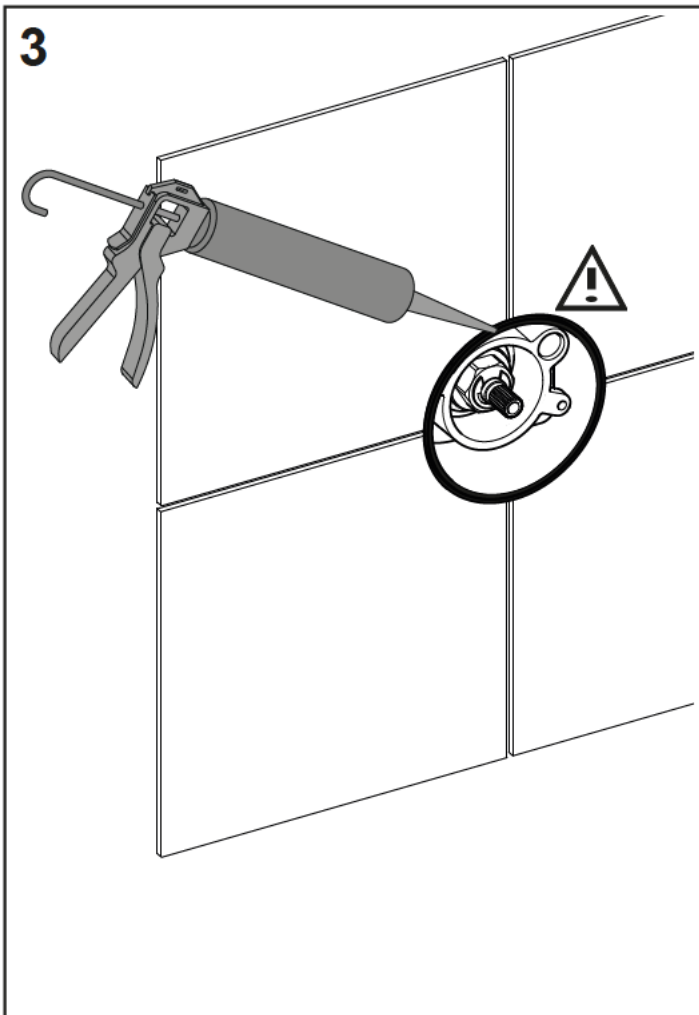
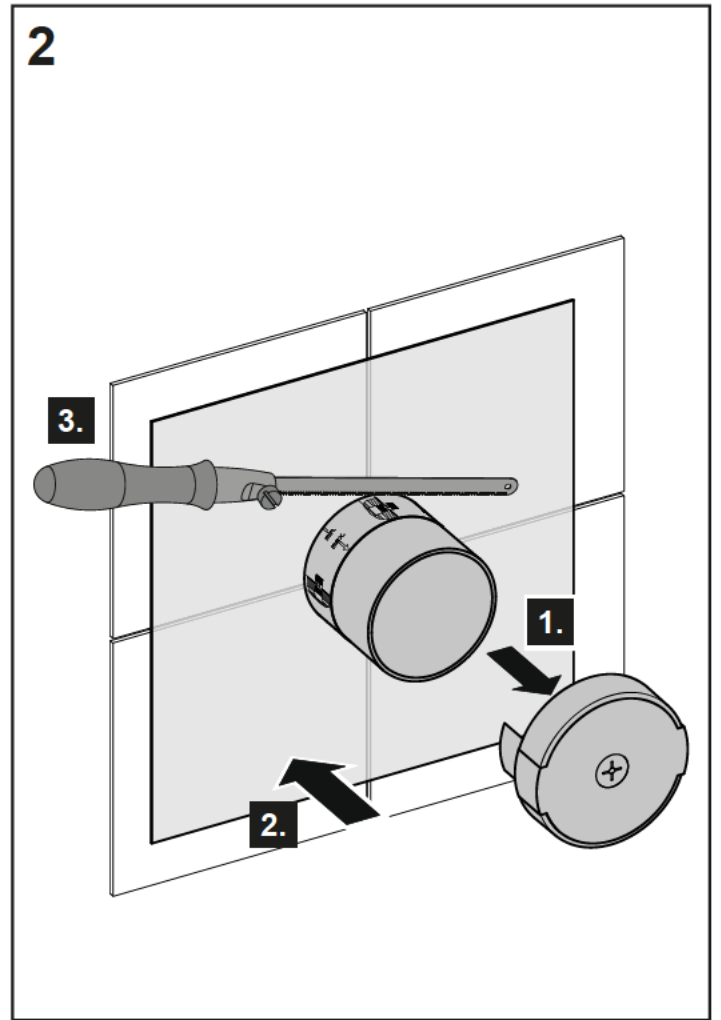
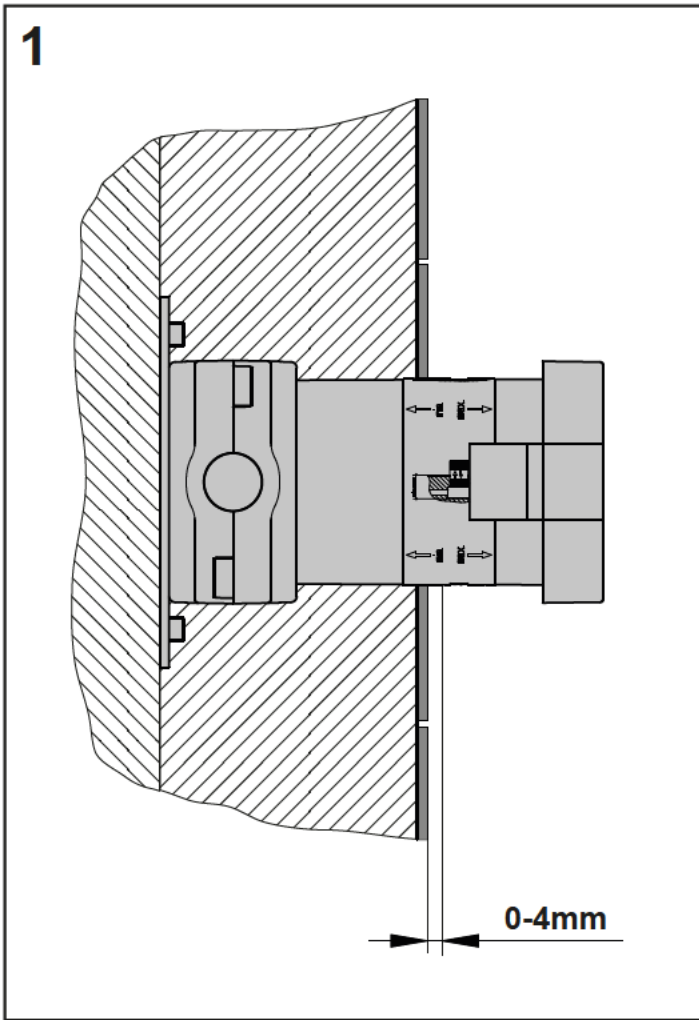

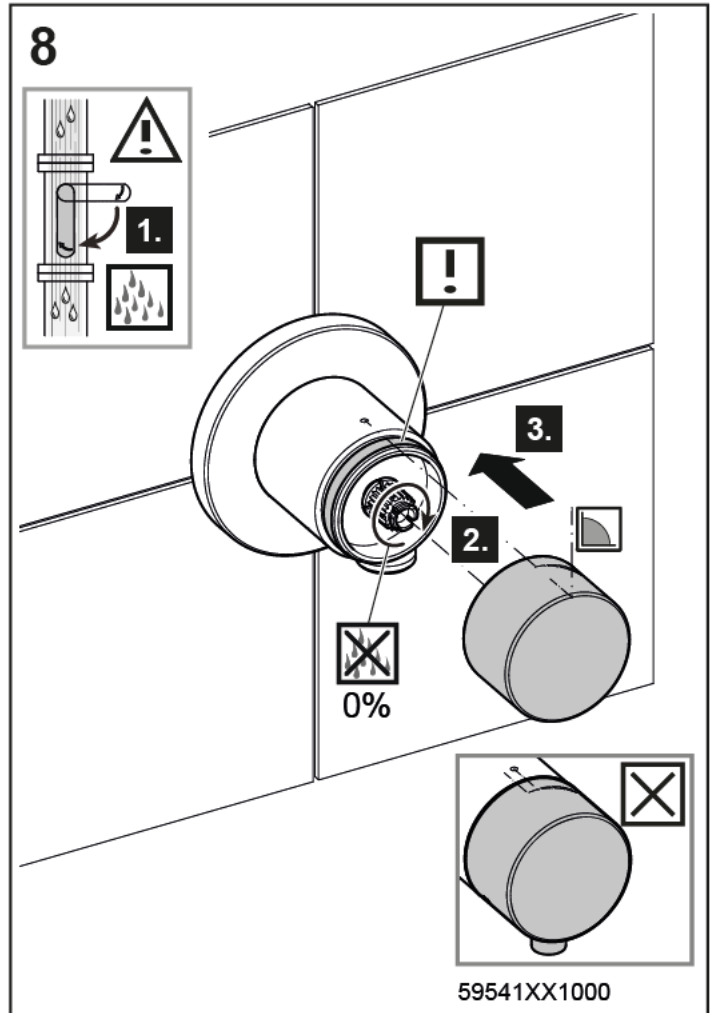
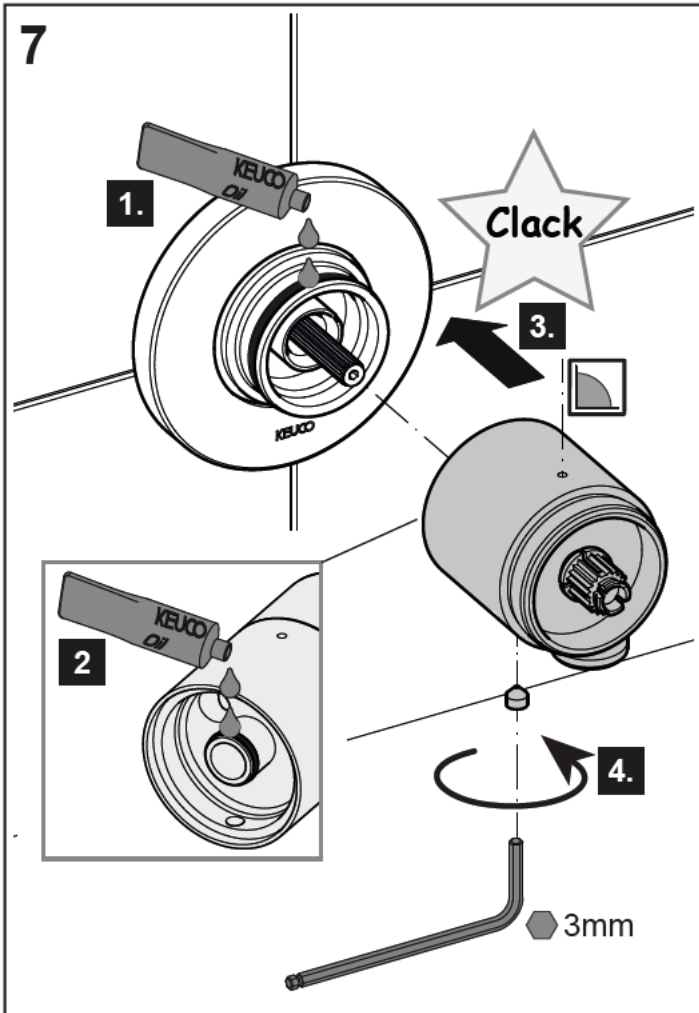
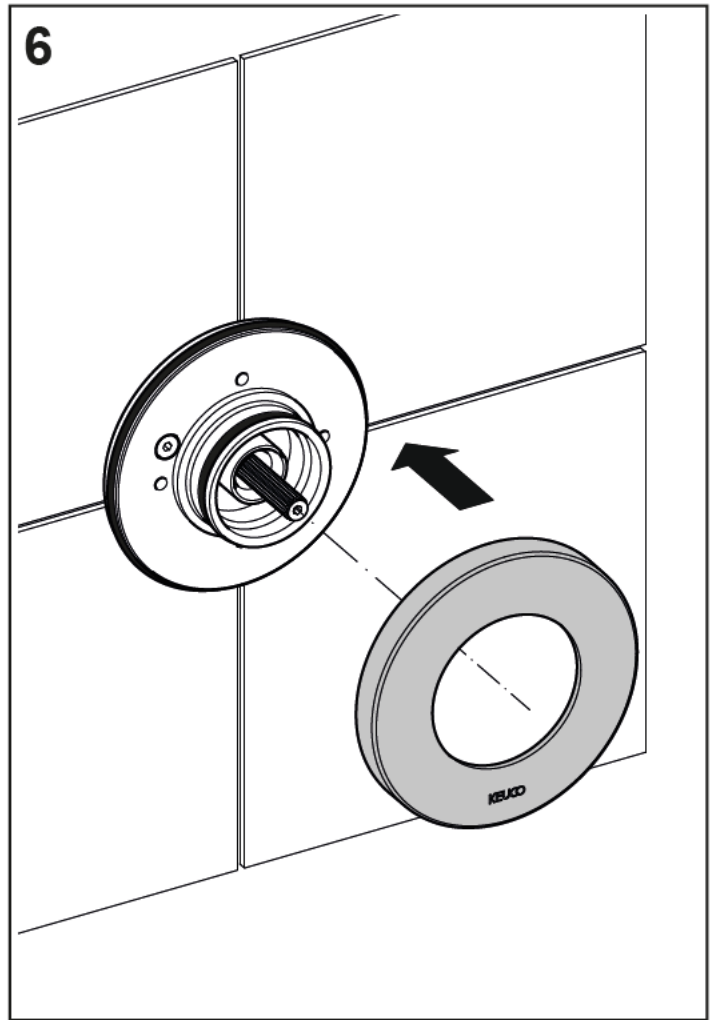
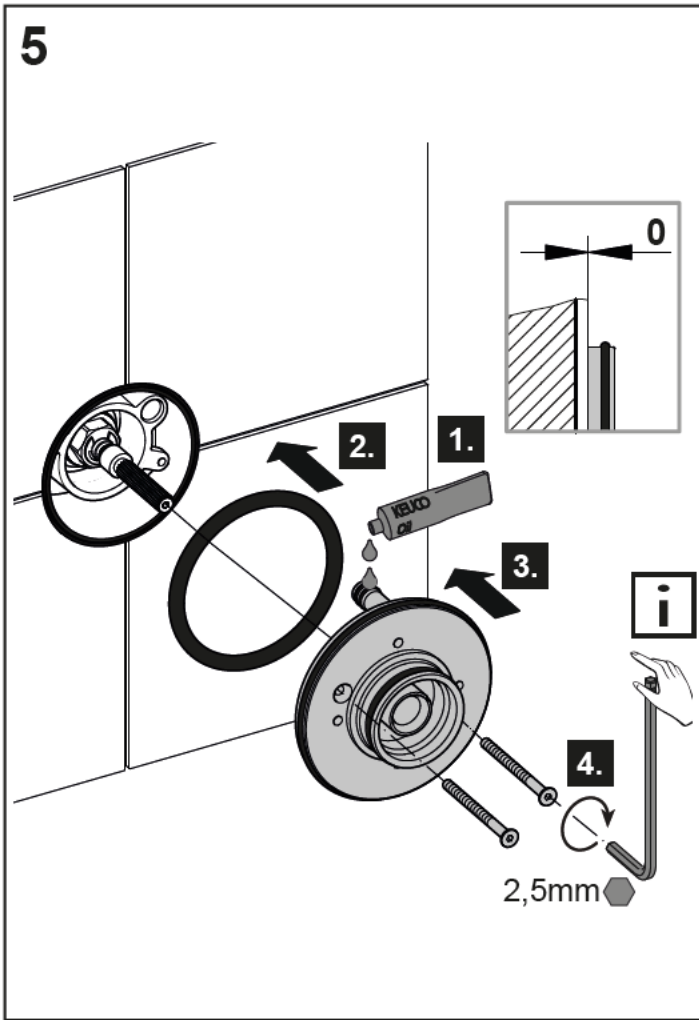

9

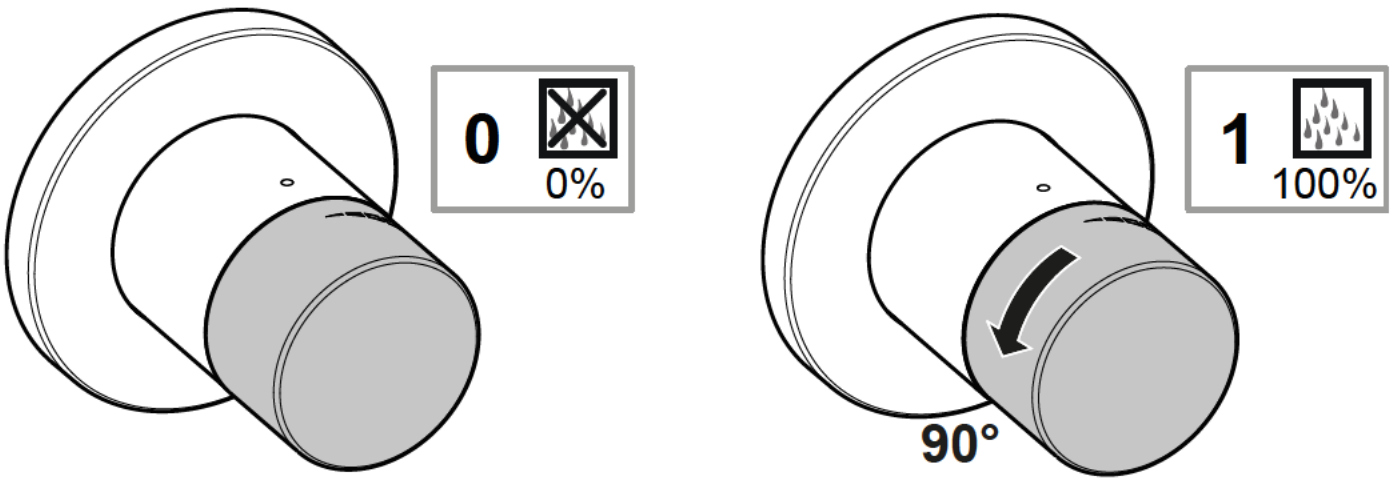

10

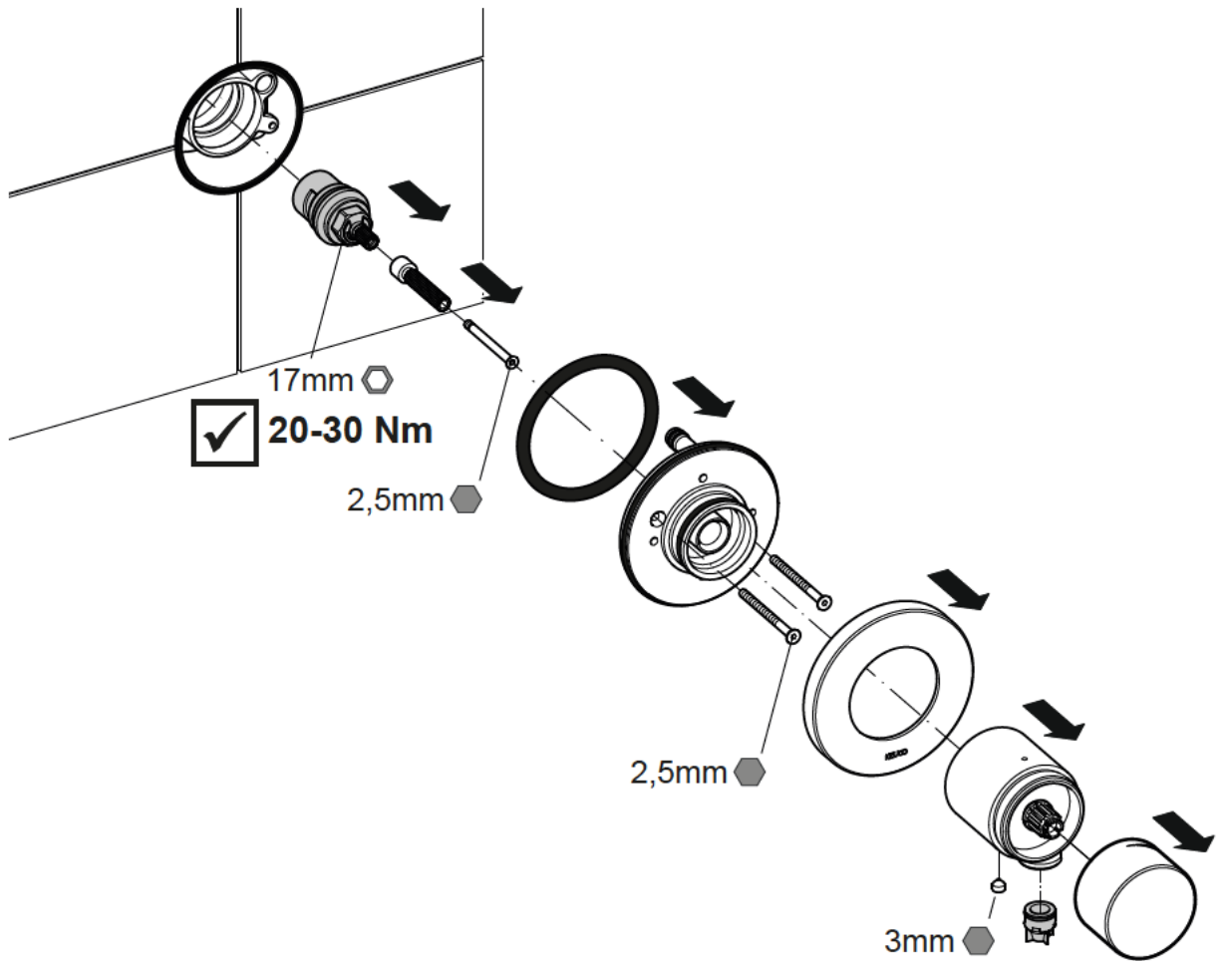

DE Ersatzteile
EN Spare parts
ES Piezas de recambio

FR Liste de pièces
IT Elenco delle parti
NL Onderdelen

CS Náhradní díly
PL Zestaw części
RU Запчасти

