

184,5

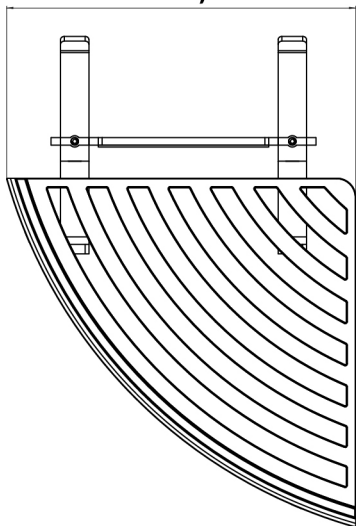

703

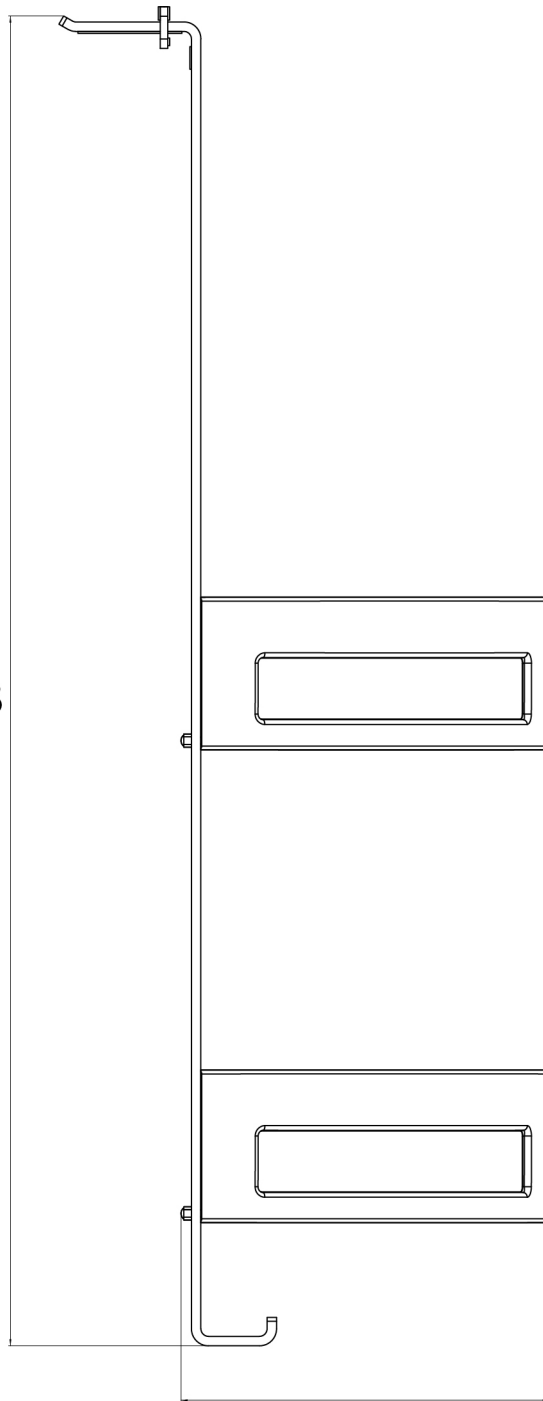

195