

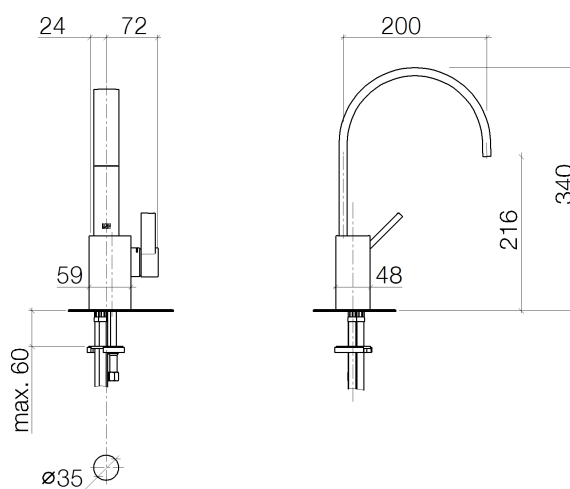

Produktspezifikationen

- ohne Ablaufgarnitur
- bleifrei



Oberflächen

- | | |
|---------------|-------------|
| • chrom | 33526782-00 |
| • platin matt | 33526782-06 |
| • platin | 33526782-08 |
| • Cyprum | 33526782-49 |

Explosionszeichnung

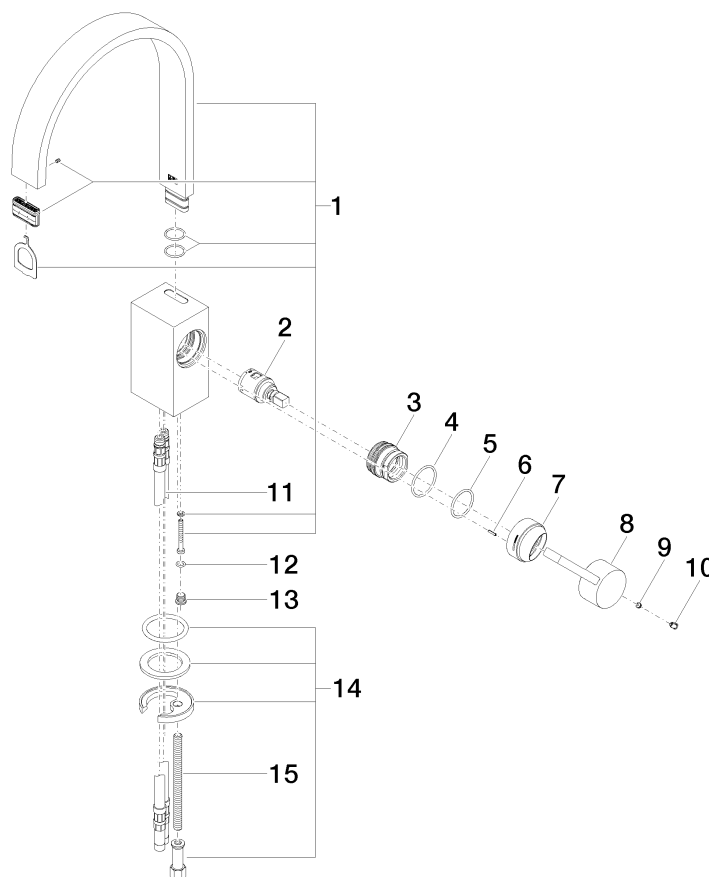

Bestellmenge

Nr.	Artikelnummer	Benennung	Verbaumenge
1	90282215201ff	Auslauf	1
2	9015050420090	Kartusche	1
3	09240428890	Mutter	1
4	09141013790	Dichtung	1
5	09141006390	Dichtung	1
6	09311115290	Stift	1
7	092830028ff	Haube	1
8	092078057ff	Griff	1
9	09311106390	Stift	1
10	09312001790	Stopfen	1
11	0430040160090	Schlauch	2
12	09141013290	Dichtung	1
13	09312002710ff	Stopfen	1
14	0430110387590	Befestigungssatz	1
15	09311101290	Stift	1

Durchflussdiagramm

