

Product information sheet SUBLINE 340/160-U

Item no. 523559

Benefits



- Maximum bowl size provided by the very best in production and mounting technology
- Mounting involves no additional expense
- Under mount bowl for discerning demands on design
- 2 in 1: two bowls, one cut-out panel and only one mounting procedure
- Timelessly elegant, contoured bowl design
- Entire system for a wide variety of plans featuring large and small bowls
- Elegant and hygienic: the covered C-overflow®
- Optional accessories

Colours

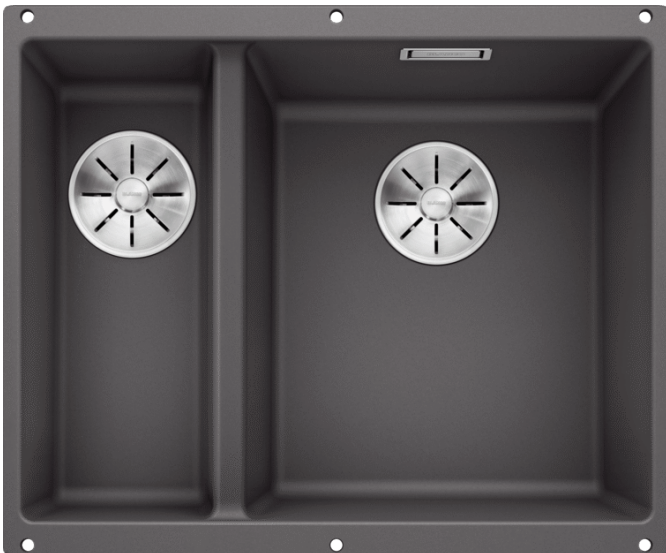

Available colours:

anthracite
alu metallic
pearl grey
white
rock grey
tartufo
jasmine
coffee
black

SILGRANIT® PuraDur® rock grey

Planning information

- Cut out size: 525 x 400 x R10
- Please state hand of bowl
- Cut out information supplied with bowls.
- Cut out CNC files also available on www.blanco.co.uk for download.

Scope of supply

- two 3 1/2" basket strainers, fixing kit 218 269 included (sealing on site)

Details

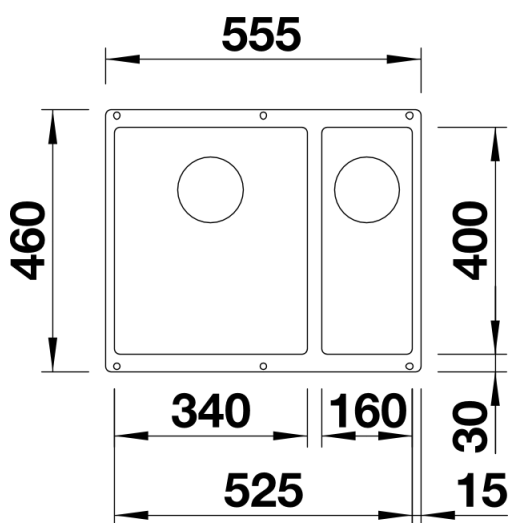

Top view

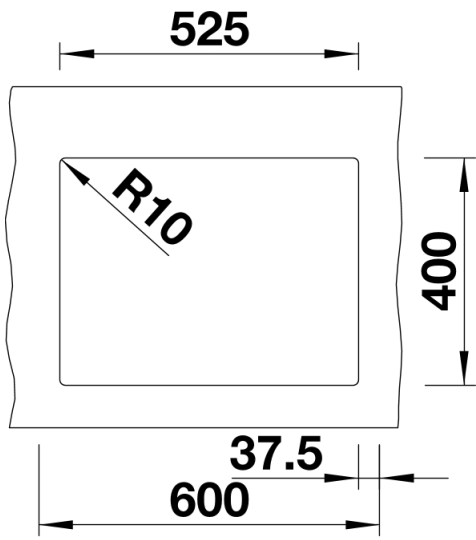

Cut-out

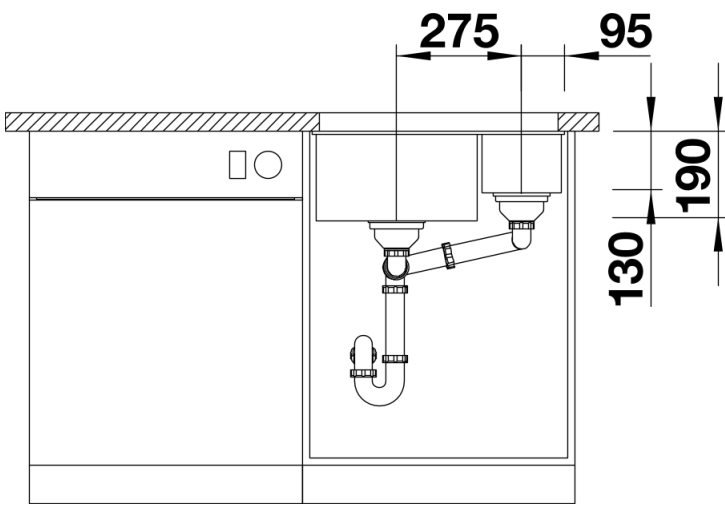

Front view

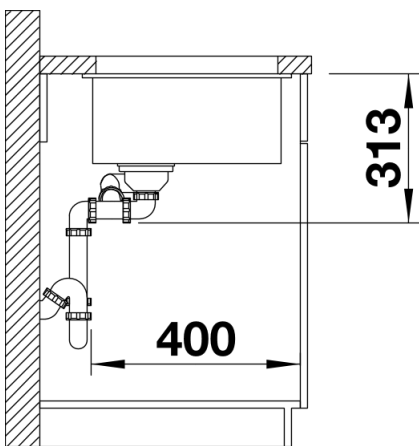

Side view