

Product information sheet SUBLINE 160-U

Item no. 523405

Benefits



- Maximum bowl size provided by the very best in production and mounting technology
- Mounting involves no additional expense
- Under mount bowl for discerning demands on design
- Timelessly elegant, contoured bowl design
- Entire system for a wide variety of plans featuring large and small bowls
- Elegant and hygienic: the covered C-overflow®
- Optional accessories

Colours



Available colours:

rock grey
alu metallic
anthracite
white
pearl grey
jasmine
coffee
tartufo
black

Planning information

- Corner radius: 10mm
- Cut out size: 160 x 400 x R10
- Cut out information supplied with bowls.
- Cut out CNC files also available on www.blanco.co.uk for download.

Scope of supply

- 3 1/2" basket strainer, fixing kit 218 269 included (sealing not included)

Details

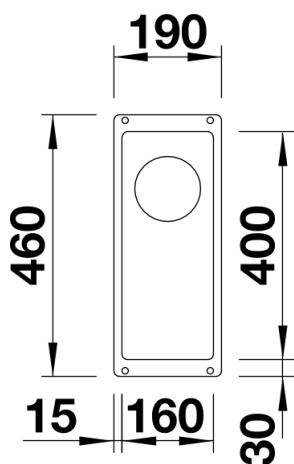

Top view

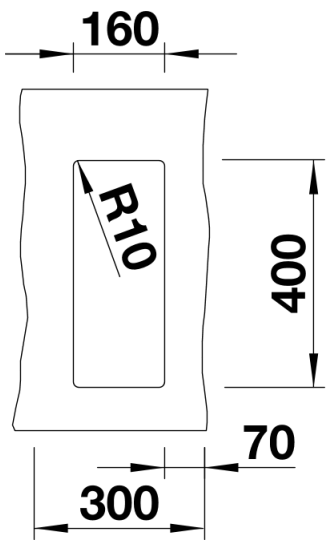

Cut-out

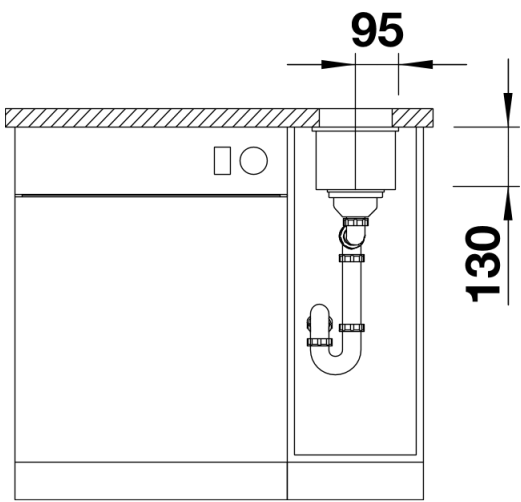

Front view

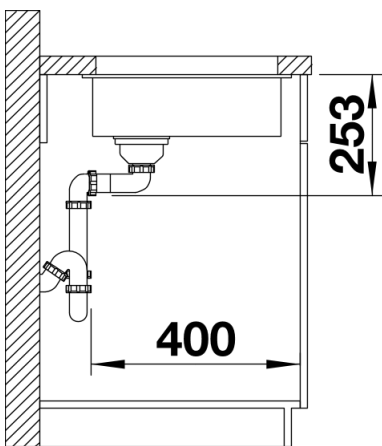

Side view