

Product information sheet CLARON 700-IF/A Durinox®

Item no. 523394

Benefits



- Pure, elegant design with concise corner radii of 10 mm
- Matt velvet Durinox™ finish paired with a Stainless steel frame
- Innovative surface: highly resistant to scratches
- With the covered C-overflow™
- InFino™ drain system
- Unique stability of the tap ledge due to the extensive stabilisation technology

Scope of supply

- With InFino® strainer plus PushControl®

Details

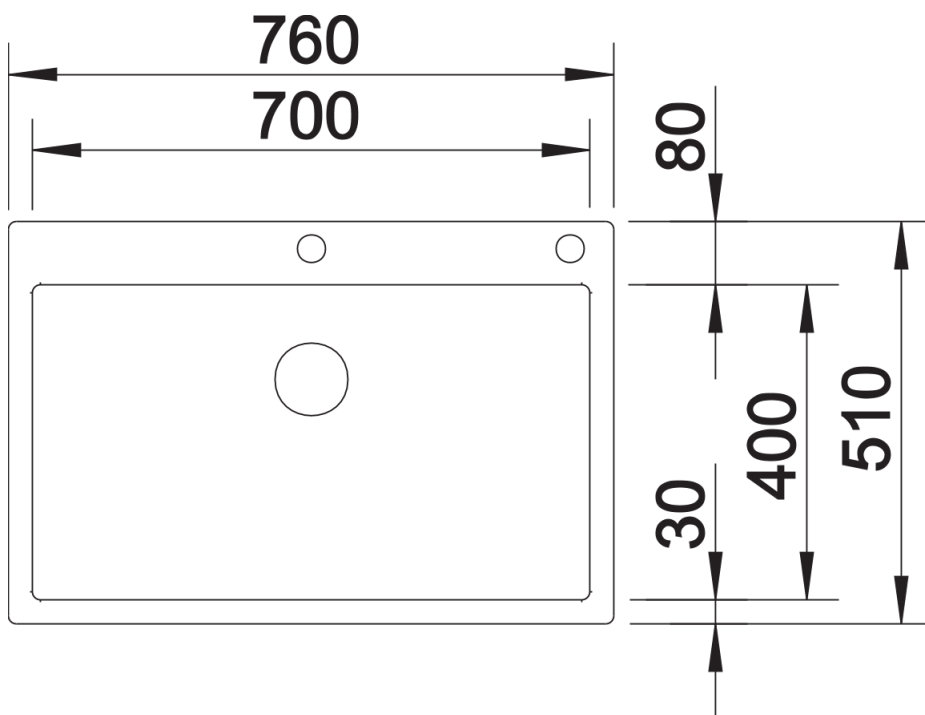

Top view