

Product information sheet ANDANO 450-IF

Item no. 522961

Benefits



- Unique composition of optical and functional elements
- The harmonious interplay between the radii and surface design creates a modern appeal
- High quality features consisting of a covered C-overflow and InFino drain system – gracefully integrated and easy-care
- Large bowl capacity and fully utilisable base
- Elegant IF flat-rim for flushmount and for installation from above
- Optional premium accessories are available

Planning information

- Flexible sealing tape is required when installing a kitchen mixer tap, drain remote control or soap dispenser in laminate worktops, item no. 120 055.
- Please note the cut-out information for the respective installation method.

Scope of supply

- waste kit with space-saving pipe, 3 1/2" InFino basket strainer, fixing kit

Details

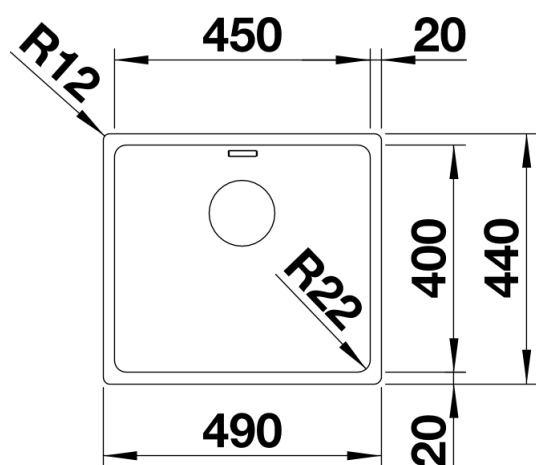

Top view

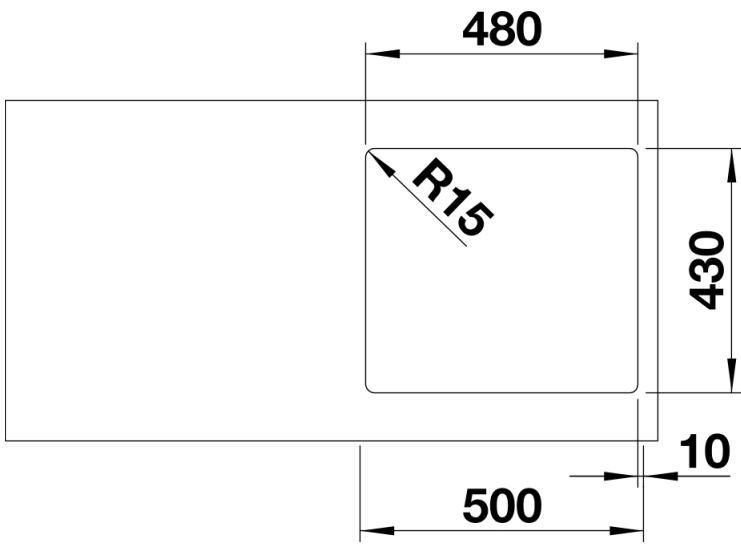

Cut-out

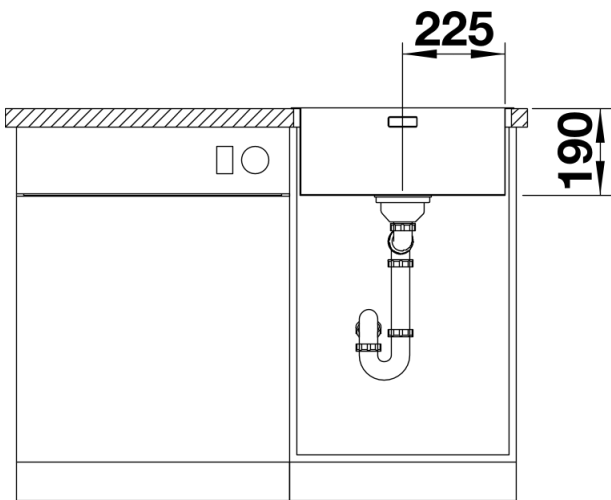

Front view

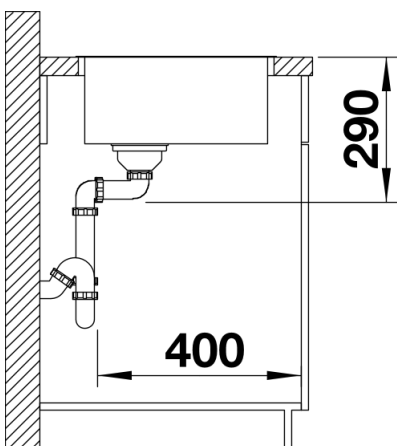

Side view