

Table of contents

1 Instructions	54
1.1 General safety instructions	54
1.2 Manufacturer liability	59
1.3 Appliance purpose	59
1.4 Identification plate	59
1.5 This user manual	59
1.6 Disposal	59
1.7 How to read the user manual	60
2 Description	61
2.1 General Description	61
2.2 Cooking hob	62
2.3 Control panel	63
2.4 Other parts	64
2.5 Available accessories	65
3 Use	67
3.1 To save energy	68
3.2 Using the accessories	69
3.3 Using the hob	70
3.4 Using the ovens	75
3.5 Cooking advice	79
3.6 Programmer clock	81
4 Cleaning and maintenance	86
4.1 Cleaning the hob	87
4.2 Cleaning the doors	88
4.3 Cleaning the oven cavities	91
4.4 Vapor Clean (multifunction oven only)	92
4.5 Extraordinary maintenance	94
5 Installation	96
5.1 Positioning	96
5.2 Electrical connection	100
5.3 Instructions for the installer	102

EN

TRANSLATION OF THE ORIGINAL INSTRUCTIONS

We advise you to read this manual carefully, as it contains all the instructions for maintaining the appliance's aesthetic and functional qualities.

For further information on the product: www.smeg.com



1 Instructions

1.1 General safety instructions

Risk of personal injury

- During use the appliance and its accessible parts become very hot. Never touch the heating elements during use.
- Protect your hands by wearing oven gloves when moving food inside the oven.
- Never try to put out a fire or flames with water: turn off the appliance and smother the flames with a fire blanket or other appropriate cover.
- This appliance may be used by children aged at least 8 and by people of reduced physical, sensory or mental capacity, or lacking in experience in the use of electrical appliances, provided that they are supervised or instructed by adults who are responsible for their safety.
- Children must not play with the appliance.
- Keep children under the age of 8 at a safe distance unless they are constantly supervised.
- Keep children under the age of 8 away from the appliance when it is in use.
- Cleaning and maintenance must not be carried out by unsupervised children.
- Be aware of how rapidly the cooking zones heat up. Do not place empty pans on the heat. Danger of overheating.
- Fats and oils can catch fire if they overheat. Do not leave the appliance unattended while preparing foods containing oils or fats. If fats or oils catch fire, never put water on them. Place the lid on the pan and turn off the relevant cooking zone.
- The cooking process must always be monitored. A short cooking process must be continuously surveyed.
- While cooking do not place metal objects, such as cutlery or dishes on the hob surface as they may overheat.



- Do not insert pointed metal objects (cutlery or utensils) into the slots in the appliance.
- Do not pour water directly on very hot trays.
- Keep the oven door closed during cooking.
- If you need to move food or at the end of cooking, open the door 5 cm for a few seconds, let the steam come out, then open it fully.
- Do not open the storage compartment (where present) when the oven is on and still hot.
- The items inside the storage compartment could be very hot after using the oven.
- DO NOT USE OR STORE FLAMMABLE MATERIALS IN THE STORAGE COMPARTMENT (IF AVAILABLE) OR NEAR THE APPLIANCE.
- DO NOT USE AEROSOLS IN THE VICINITY OF THIS APPLIANCE WHILST IT IS IN USE.
- Switch off the appliance immediately after use.
- DO NOT MODIFY THIS APPLIANCE.
- Always use any necessary/required personal protective equipment (PPE) before performing any work on the appliance (installation, maintenance, positioning or movement).
- Before performing any operation on the appliance, switch off the power supply.
- Have qualified personnel carry out installation and assistance interventions according to the standards in force.
- Do not try to repair the appliance yourself or without the intervention of a qualified technician.
- Do not pull the cable to remove the plug.
- If the power supply cable is damaged, contact technical support immediately and they will replace it.



Instructions

Risk of damaging the appliance

- Do not use abrasive or corrosive detergents (e.g. scouring powders, stain removers and metallic sponges) on glass parts.
- Use wooden or plastic utensils.
- Racks and trays should be inserted as far as they will go into the side guides. The mechanical safety locks that prevent them from being removed must face downwards and towards the back of the oven cavity.
- Do not sit on the appliance.
- Do not use steam jets to clean the appliance.
- Do not obstruct ventilation openings and heat dispersal slots.
- Never leave the appliance unattended during cooking operations where fats or oils could be released, as these could then heat up and catch fire. Be very careful
- Never leave objects on the cooking surface.
- DO NOT USE THE APPLIANCE TO HEAT ROOMS FOR ANY REASON.
- Do not spray any spray products near the oven.
- Do not use plastic cookware or containers for cooking.
- Do not place sealed tins or containers in the oven cavity.
- Remove all trays and racks which are not required during cooking.
- Do not cover the bottom of the oven cavity with aluminium or tin foil sheets.
- Do not place pans or trays directly on the bottom of the oven cavity.
- If you wish to use greaseproof paper, place it so that it will not interfere with the hot air circulation inside the oven.
- Do not use the open door to place pans or trays on the internal glazing pane.
- Cooking vessels or griddle plates should be placed inside the perimeter of the hob.
- All pans must have smooth, flat bottoms.



- If any liquid does boil over or spill, remove the excess from the hob.
- Take care not to spill acid substances such as lemon juice or vinegar on the hob.
- Do not put empty pans or frying pans on switched on cooking zones.
- If cracks or fissures form, or if the glass ceramic cooking surface breaks, turn off the appliance immediately. Disconnect the power supply and call Technical Support.
- People who have pacemakers or other similar devices fitted must make sure that the operation of these devices is not jeopardised by the inductive field, whose frequency range is between 20 and 50 kHz.
- In conformity with the provisions regarding electromagnetic compatibility, the electromagnetic induction cooking hob comes under group 2 and class B (EN 55011).
- Do not use steam jets to clean the appliance.
- Do not use rough or abrasive materials or sharp metal scrapers.
- Do not use cleaning products containing chlorine, ammonia or bleach on parts made of steel or that have metallic surface finishes (e.g. anodizing, nickel- or chromium-plating).
- Do not use abrasive or corrosive detergents (e.g. scouring powders, stain removers and metallic sponges) on glass parts.
- Do not wash the removable components such as the hob grids, flame-spreader crowns and burner caps in a dishwasher.
- Never use the oven door to lever the appliance into place when fitting.
- Avoid exerting too much pressure on the door when open.
- Do not use the handle to lift or move this appliance.



Instructions

Installation

- THIS APPLIANCE **MUST NOT BE INSTALLED** IN A BOAT OR CARAVAN.
- The appliance must not be installed on a pedestal.
- Position the appliance into the cabinet cut-out with the help of a second person.
- To prevent any possible overheating, the appliance should not be installed behind a decoration door or a panel.
- Have the electrical connection performed by authorised technicians.
- The appliance must be connected to ground in compliance with electrical system safety standards.
- Use cables withstanding a temperature of at least 90 °C.
- The tightening torque of the screws of the terminal board leads must be 1.5 - 2 Nm.

For this appliance

- After use, turn off the plates. Never rely solely on the cookware detector.
- Supervise children carefully as they cannot readily see the indication of residual heat. After use the cooking zones remain hot for a certain period of time even if they have been turned off. Keep children away from the cooking zones.
- The glass ceramic surface is highly resistant to impacts. However, avoid hard, solid objects falling on the cooking surface as they may cause it to break if they are sharp.
- The glass ceramic cooking surface must not be used as a surface for placing objects.
- Ensure that the appliance is switched off before replacing the bulb.
- Do not rest any weight or sit on the open door of the appliance.
- Take care that no objects are stuck in the doors.



1.2 Manufacturer liability

The manufacturer declines all liability for damage to persons or property caused by:

- Use of the appliance other than that specified;
- failure to comply with the instructions in the user manual;
- tampering with any part of the appliance;
- use of non-original spare parts.

1.3 Appliance purpose

- This appliance is intended for cooking food in the home environment. Every other use is considered inappropriate.
- The appliance is not designed to operate with external timers or with remote-control systems.

1.4 Identification plate

The identification plate bears the technical data, serial number and brand name of the appliance. Do not remove the identification plate for any reason. Once installed the rating plate can only be accessed from the rear of the cooker, for this reason you are strongly advised to stick the spare rating plate (included in the packaging of the cooker), to the back of this user manual for reference.

1.5 This user manual

This user manual is an integral part of the appliance and must therefore be kept in its entirety and within the user's reach for the whole working life of the appliance.

Read this user manual carefully before using the appliance.

1.6 Disposal



This appliance must be disposed of separately from other waste (Directives 2002/95/EC, 2002/96/EC, 2003/108/EC). The appliance does not contain substances in quantities sufficient to be considered hazardous to health and the environment, in accordance with current European directives.

To dispose of the appliance:

- Cut the power supply cable and remove it along with the plug.



Power voltage

Danger of electrocution

- Disconnect the mains power supply.
- Unplug the appliance.



Instructions

- Deliver the appliance to the appropriate recycling centre for electrical and electronic equipment waste, or return it to the retailer when purchasing an equivalent product, on a one for one basis.

Our appliances are packaged in non-polluting and recyclable materials.

- Deliver the packing materials to the appropriate recycling centre.



Plastic packaging Danger of suffocation

- Do not leave the packaging or any part of it unattended.
- Do not let children play with the plastic bags.

1.7 How to read the user manual

This user manual uses the following reading conventions:

Instructions



General information on this user manual, on safety and final disposal.

Description



Description of the appliance and its accessories.

Use



Information on the use of the appliance and its accessories.

Cleaning and maintenance



Information for proper cleaning and maintenance of the appliance.

Installation



Information for the qualified technician: Installation, operation and inspection.



Safety instructions



Information



Advice

1. Use instruction sequence.

- Standalone instruction.



2 Description

2.1 General Description

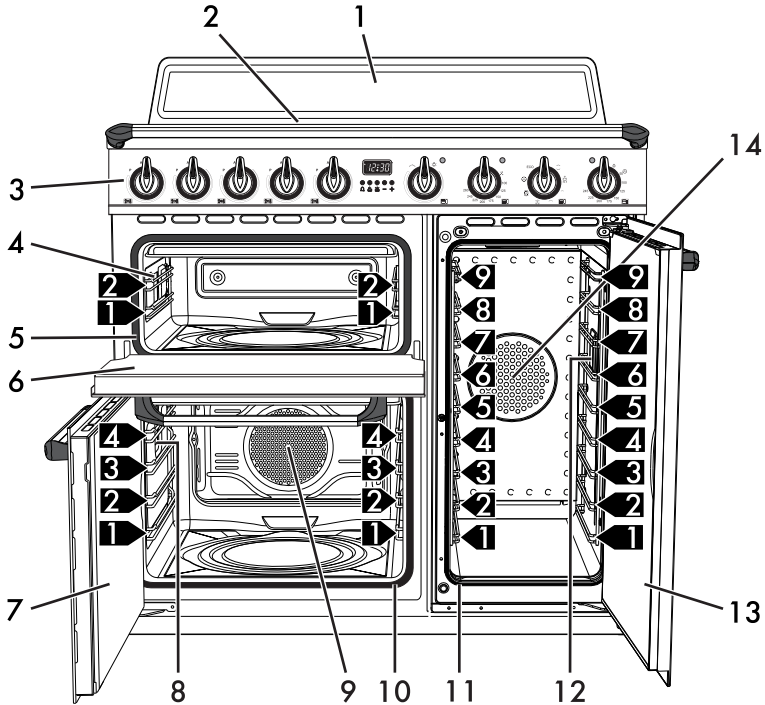

1 Upstand

2 Cooking hob

3 Control panel

1,2,3 Rack/tray support frames

4 Auxiliary oven light

5 Auxiliary oven seal

6 Auxiliary oven door

7 Multifunction oven door

8 Multifunction oven light

9 Multifunction oven fan

10 Multifunction oven seal

11 Vertical oven seal

12 Vertical oven light

13 Vertical oven door

14 Vertical oven fan



Description

2.2 Cooking hob

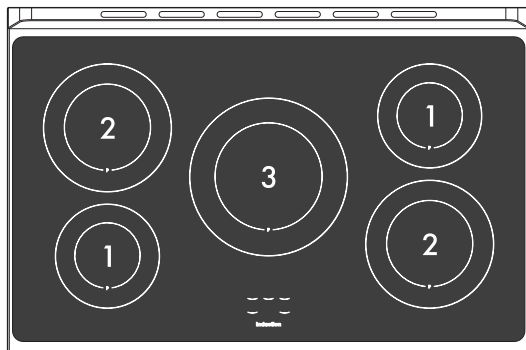

Zone	Outer diameter (mm)	Max. power absorbed (W)*	Power consumption in Booster function (W)*
1	180	1300	1400
2	210	2300	3000
3	270	2300	3000

* Power levels are approximate and can vary according to the pan used or the settings made.

Advantages of induction cooking



The hob is equipped with an induction generator for each cooking zone. Each generator located under the glass ceramic cooking surface creates an electromagnetic field which induces a thermal current in the base of the pan. This means the heat is no longer transmitted from the hob to the pan but created directly inside the pan by the inductive current.

- Energy saving thanks to the direct transmission of energy to the pan (suitable magnetisable cookware is required) compared to traditional electric cooking.
- Improved safety as the energy is only transmitted to the pan placed on the hob.
- High level of energy transmitted from the induction cooking zone to the base of the pan.
- Rapid heating speed.
- Reduced danger of burns as the cooking surface is only heated under the base of the pan; foods which overflow do not stick.



2.3 Control panel

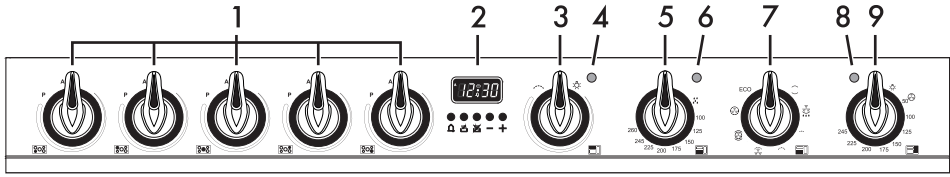

1 Hob cooking zone knobs

Useful for controlling the cooking zones of the induction hob.

Turn the knobs clockwise to adjust the operating power of the hot plate from a minimum of **1** to a maximum of **9**.

The working power is indicated on the display on the hob.

2 Programmer clock

For displaying the current time, setting programmed cooking operations and the minute minder timer.

3 Auxiliary oven variable grill knob

It turns on the light inside the oven or starts the grill heating element to a temperature ranging from a minimum of **50 °C** to a maximum of **245 °C**.

4 Auxiliary oven variable grill indicator light

The indicator light comes on to indicate that the auxiliary oven is heating up. It turns off as soon as it reaches the set temperature. It flashes regularly to indicate that the temperature set inside the oven is kept constant.

5 Multifunction oven temperature knob

This knob allows you to select the cooking temperature and the Vapor Clean temperature.

Turn the knob clockwise to the required value, between the minimum and maximum setting.

6 Multifunction oven indicator light

The indicator light comes on to indicate that the oven is heating up. It turns off as soon as it reaches the set temperature. It flashes regularly to indicate that the temperature set inside the oven is kept constant.



Description

7 Multifunction oven function knob

The oven's various functions are suitable for different cooking methods. After selecting the required function, set the cooking temperature using the temperature knob.

8 Vertical oven indicator light

The indicator light comes on to indicate that the oven is heating up. It turns off as soon as it reaches the set temperature. It flashes regularly to indicate that the temperature set inside the oven is kept constant.

9 Vertical oven temperature knob

It turns on the light inside the oven cavity or starts the round heating elements to a temperature ranging from a minimum of 50 °C to a maximum of 245 °C.

2.4 Other parts

Shelves

The appliance features shelves to position trays and racks at different heights. The insertion heights are indicated from the bottom upwards (see 2.1 General Description).

Cooling fan

The fan cools the ovens and comes into operation during cooking.

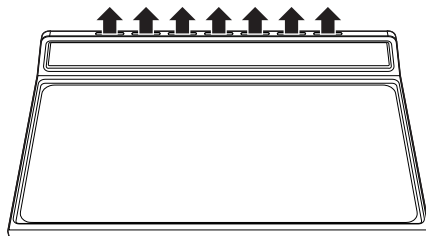

The fan causes a steady outflow of air that exits from the rear of the appliance and which may continue for a brief period of time even after the appliance has been turned off.



Do not obstruct ventilation openings and heat dispersal slots.

Interior lighting

The internal light of the appliance comes on when any function is started:

- **Multifunction oven:** turn the function knob to any function (apart from the function **ECO**).
- **Auxiliary oven:** turn the variable grill knob to the  symbol or select a cooking temperature.
- **Vertical oven:** turn the temperature knob to the  symbol or select a cooking temperature.



2.5 Available accessories

Tray rack

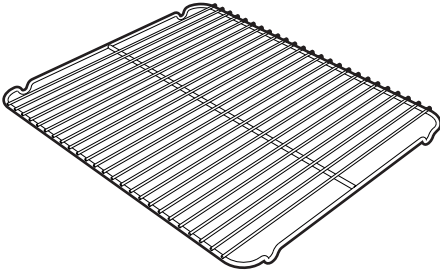

To be placed over the top of the oven tray; for cooking foods which may drip.

Oven tray

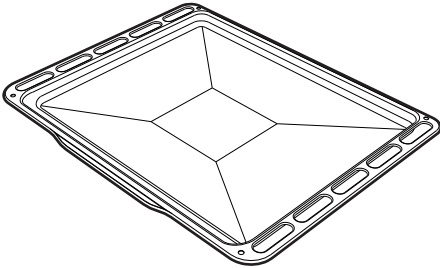

Useful for collecting fat from foods placed on the rack above.

Deep tray

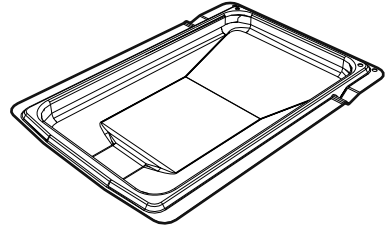
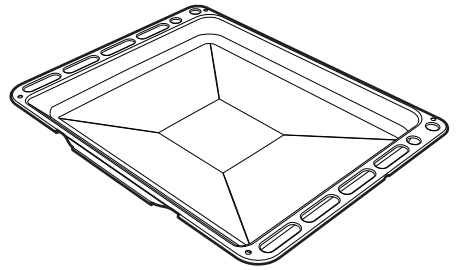

Useful for collecting fat from foods placed on the rack above and for cooking pies, pizzas and baked desserts.



Description

Rack

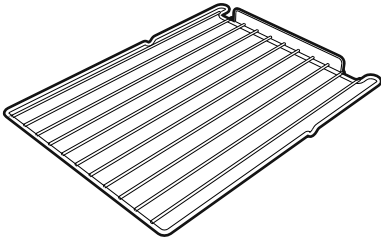
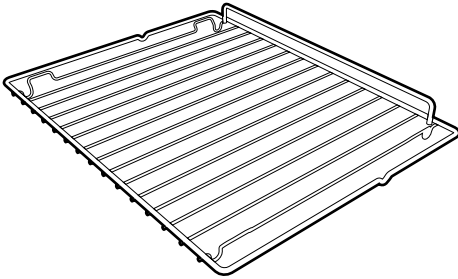

Used for supporting containers with food during cooking.

Plate rack

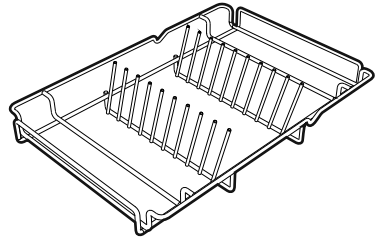

To be used for warming plates.

i Not all accessories are available on some models.

i The accessories intended to come into contact with food are made of materials that comply with the provisions of current legislation.

i Supplied and optional accessories can be requested to Authorised Service Centres. Use only original accessories supplied by the manufacturer.



3 Use

Instructions



High temperature inside the oven during use Danger of burns

- Keep the oven door closed during cooking.
- Protect your hands by wearing oven gloves when moving food inside the oven.
- Do not touch the heating elements inside the appliance.
- Do not pour water directly on very hot trays.
- Keep children under the age of 8 away from the appliance when it is in use.
- If you need to move food or at the end of cooking, open the door 5 cm for a few seconds, let the steam come out, then open it fully.
- Oils and fats could catch fire if overheated. Be very careful.



High temperature inside the storage compartment Danger of burns

- Do not open the storage compartment when the oven is on and still hot.
- The items inside the storage compartment could be very hot after using the oven.



Improper use Risk of damage to surfaces

- Do not cover the bottom of the oven cavity with aluminium or tin foil sheets.
- If you wish to use greaseproof paper, place it so that it will not interfere with the hot air circulation inside the oven cavity.
- Do not place pans or trays directly on the bottom of the oven cavity.
- Do not use the open door to place pans or trays on the internal glazing pane.
- Do not pour water directly on very hot trays.
- Cooking vessels or griddle plates should be placed inside the perimeter of the hob.
- All pans must have smooth, flat bottoms.
- If any liquid does boil over or spill, remove the excess from the hob.
- Never place pans with bases which are not perfectly flat and smooth.
- Avoid hard, solid objects falling on the surface of the hob.
- In case you notice cracks or fissures, turn off the appliance immediately, disconnect the power supply and contact Technical Support.
- Do not use the hob as a support surface.



Use



High temperature inside the storage compartment during use Danger of fire or explosion

- Do not spray any spray product near the appliance.
- Do not use or leave flammable materials near the oven or the storage compartment.
- Do not use plastic cookware or containers for cooking.
- Do not place sealed tins or containers in the oven cavity.
- Do not leave the appliance unattended during cooking operations where fats or oils could be released.
- Remove all trays and racks which are not required during cooking.

First use

1. Remove any protective film from the outside or inside of the appliance, including accessories.
2. Remove any labels (apart from the technical data plate) from the accessories and from the cooking compartments.
3. Remove and wash all the appliance's accessories (see 4 Cleaning and maintenance).

Oven cavity

4. Heat the empty oven at the maximum temperature to burn off any residues left by the manufacturing process.

Glass ceramic hob

5. Place a pan full of water on each of the front cooking zones and switch them on to the maximum power setting for at least 30 minutes.
6. After 30 minutes, switch off the front cooking zones and repeat this operation for the rear cooking zones and any central cooking zone.
7. If after carrying out the above operations the controls do not work properly, it might be necessary to extend the operations until the moisture has completely evaporated.

3.1 To save energy

- Preheat the appliance only if the recipe requires it.
- Unless differently stated on the package, defrost frozen food before placing it in the cooking compartment.
- In case of multiple cooking, it is recommended to cook food one after the other to exploit the already hot cooking compartment.
- Use dark metal moulds: They help to absorb the heat better.
- Remove all trays and racks which are not required during cooking.



- Stop cooking a few minutes before the time normally used. Cooking will continue for the remaining minutes with the heat which has accumulated inside the oven.
- Reduce any opening of the door to a minimum to avoid heat dispersal.
- Keep the cooking compartment clean at all times.

3.2 Using the accessories

Tray rack

The tray rack has to be inserted into the tray. In this way fat can be collected separately from the food which is being cooked.

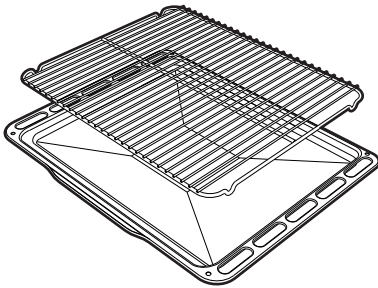

Racks and trays

Racks and trays have to be inserted into the side guides until they come to a complete stop.

- The mechanical safety locks that prevent the rack from being taken out accidentally have to face downwards and towards the oven back.

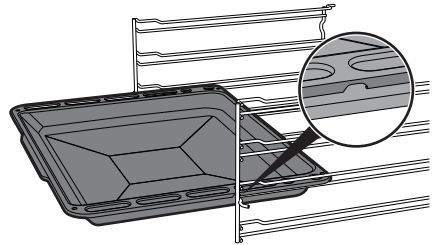
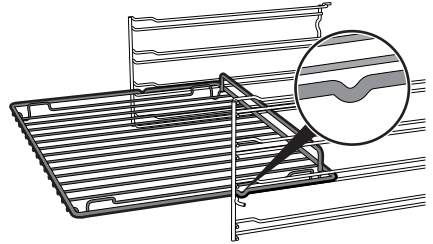

Gently insert racks and trays into the oven until they come to a stop.



Clean the trays before using them for the first time to remove any residues left by the manufacturing process.



Use

Plate rack

1. Insert the plate rack without plates in the first shelf of the side oven.
2. Position the plates as shown in the figure.

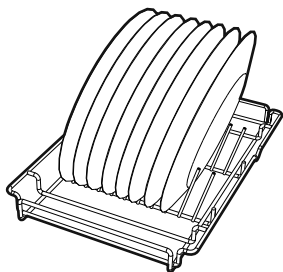

3. Heat the oven to a temperature no greater than 50 °C for no more than 15 minutes.
4. After heating, extract the support slightly, leaving it on the rails.
5. Ensure that the support is stable and balanced, then remove the plates.



Use oven gloves when handling cooking zones.

3.3 Using the hob



On first connection to the electrical mains, an automatic check will be carried out that will switch on all indicator lights for a few seconds.



After use, turn off the hot plates used by returning the appropriate knob to the **O** position. Never rely solely on the cookware detector.

All the appliance's control and monitoring devices are located together on the front panel. The relevant cooking zone is indicated next to each knob.

Just turn the knob clockwise to the required power setting.

Cookware suitable for use in induction cooking

Cookware used on the induction cooking surface must be made of metal, with magnetic properties and a sufficiently large base.

Suitable cookware:

- Enamelled steel cookware with thick bases.
- Cast iron cookware with an enamelled base.
- Cookware in multilayer stainless steel, ferritic stainless steel and aluminium with a special base.

Unsuitable cookware:

- Copper, stainless steel, aluminium, fireproof glass, wood, ceramic and terracotta cookware.



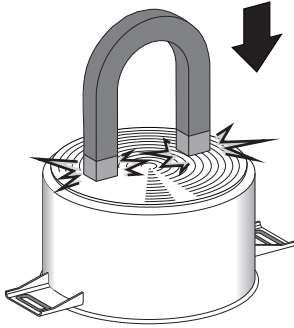

To see whether the pan is suitable, bring a magnet close to the bottom: if it is attracted, the pan is suitable for induction cooking. If you do not have a magnet, you can put a small amount of water in the pan, place it on a cooking zone and start the cooking zone. If the symbol  appears on the display, it means the pan is not suitable.



Use only cookware with a perfectly flat bottom which is suitable for induction hot plates. Using cookware with an irregular bottom could jeopardise the efficiency of the heating system and prevent cookware from being detected on the cooking zone.

Cookware recognition

When there is no saucepan on a cooking zone or if the saucepan is too small, no energy will be transmitted and the symbol  will appear on the display.

If there is a suitable saucepan on the cooking zone, the recognition system notices it and turns on the hob to the power level set using the knob. Energy transmission is also interrupted when the saucepan is removed from the cooking zone (the symbol  will be shown on the display).

If the cookware recognition function is activated in spite of the saucepan or frying pan on the cooking zone being smaller than the zone itself, only the necessary energy will be transmitted.

Cookware recognition limits: the minimum diameter of the pan base is indicated by a circle inside the cooking zone. Pans with smaller diameters risk not being detected and therefore not activating the inductor.



Limiting the cooking duration

The hob has an automatic device which limits the duration of use.

If the cooking zone settings are not changed, the maximum duration of operation for each zone depends on the power level selected.

When the device for limiting the duration of use is activated, the cooking zone turns off, a short alert sounds and, if the zone is hot, the **H** symbol appears on the display.

Set power level	Maximum cooking duration in hours
1	8
2	6
3 - 4	5
5	4
6 - 7 - 8 - 9	1 ½

Protection from overheating

If the hob is used on full power for a long period, the electronics will have trouble cooling down if the room temperature is high.

To avoid excessively high temperatures forming in the electronics, the power to the cooking zone is reduced automatically.

Advice on energy-saving

- The diameter of the base of the pan must correspond to the diameter of the cooking zone.



- When buying a pan, check whether the diameter indicated is that of the base or the top of the pan, as the top is almost always larger than the base.
- When preparing dishes with long cooking times, you can save time and energy by using a pressure cooker, which also makes it possible to preserve the vitamins in the food.
- Make sure that the pressure cooker contains enough liquid as, if there is not enough and it overheats, this may cause damage to both the pressure cooker and the cooking zone.
- If possible, always cover saucepans with a suitable lid.
- Choose a pan suitable for the quantity of food to be cooked. A large, half-empty saucepan leads to a waste of energy.



Under certain circumstances, if the hob and the oven are being used at the same time, the maximum power limit that can be used by the electrical system might be exceeded.



Power levels

The power in the cooking zone can be adjusted to various levels. The table shows the levels suitable for various types of cooking.

Power level	Suitable for:
0	OFF setting
U	Keep warm
1 - 2	Cooking small amounts of food (minimum power)
3 - 4	Cooking
5 - 6	Cooking large quantities of food, roasting larger portions
7 - 8	Roasting, slow frying with flour
9	Roasting
p *	Roasting / browning, cooking (maximum power)

* see booster function

Residual heat



Improper use Danger of burns

- Supervise children carefully as they cannot easily see the residual heat indicator. The cooking zones remain hot for a certain period of time even after they have been turned off. Make sure that children never touch the hob.

If the cooking zone is still hot after being switched off, the symbol **H** will be displayed on the display. The symbol clears once the temperature drops below 60 °C.

Heating accelerator



Each cooking zone is equipped with a heating accelerator that allows the maximum power to be delivered for a time that is proportional to the selected power.

This function allows the selected power to be achieved in the shortest amount of time.

- Turn the knob anti-clockwise to position **A** and then release it. The display shows the symbol **A**.
- Select the required heating power (**1 - 8**) within 3 seconds. The selected power and symbol **A** will flash alternately on the display.

The power level can be increased at any moment. The "maximum power" period will automatically be modified.

Once the acceleration period is over the power level will remain the same as the one previously selected.



If the power is reduced, by turning the knob anti-clockwise, the heating accelerator will automatically be disabled.



Keep warm

i The Keep warm function allows you to keep cooked food hot.

To activate the keep warm function:

- Turn the knob for the desired cooking zone until the  symbol appears on the corresponding display.

Booster function

i The booster function allows the cooking zone to be activated at maximum power for as long as 5 minutes. It can be used to bring a large quantity of water to a boil rapidly or to broil meat.

- Turn the knob clockwise to the **P** position for two seconds and then release.

The display shows the symbol . After 5 minutes the Booster function will automatically be disabled and cooking will continue at power level **9** (on zones **2** and **3** only).

i The booster function has priority over the heating accelerator function.

Power control

The hob is fitted with a power control module that optimises/limits consumption. If the overall set power level exceeds the maximum limit permitted, the electronic circuit board will automatically manage the power supplied by the hot plates.

The module tries to maintain the maximum deliverable power levels. Levels set by the automatic control will appear on the display.

The flashing of a power level indicates that it will be automatically limited to a new level selected by the power control module.

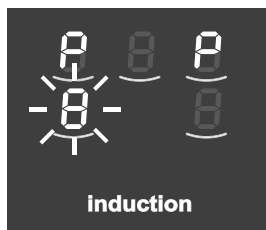

i Priority is given to the last zone set.



Control lock

i The controls lock is a device that protects the appliance from accidental or inappropriate use.

1. With all cooking zones off, simultaneously turn counterclockwise the two knobs - among those for cooking control - for the front and rear left cooking zones (position **A**).
2. Keep them turned until the symbols **L** appear on the display.
3. Release the knobs.

In order to remove the control lock repeat the same operations described previously.

i If the knobs have been kept turned to the **A** position for more than 30 seconds a fault message is displayed **L**.

L After a prolonged period of interruption to the power supply, the control lock will be deactivated. If this is the case, turn it back on as described above.

Error codes

If the display shows one of the following error codes **L**, **E**, contact Technical Assistance.

3.4 Using the ovens

Opening and closing the doors of the multifunction/vertical ovens

The multifunction and vertical ovens are equipped with a swing door. To open, pull the door handle towards you. To close, push the doors until you hear a mechanical "click".

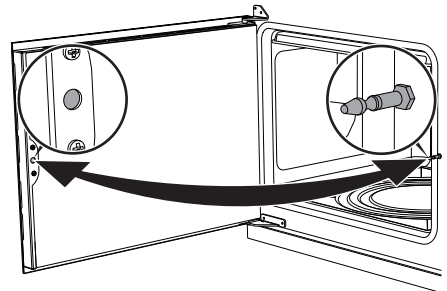

L The doors are not held in place when open and may tend to reclose. During use, pay attention not to come into contact with the internal glass pane to prevent burns.



L Over time the swing doors might get difficult to open and close. Grease the hinges.



Switching on the multifunction oven



Ensure that the programmer clock shows the cooking duration symbol  otherwise it will not be possible to turn on the oven.

Press the keys  and  at the same time to reset the programmer clock.

To switch on the multifunction oven:

1. Select the cooking function using the function knob.

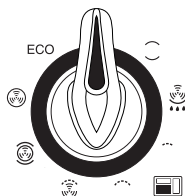

2. Select the temperature using the temperature knob.

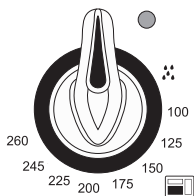

Multifunction oven functions



Static

As the heat comes from above and below at the same time, this system is particularly suitable for certain types of food. Traditional cooking, also known as static cooking, is suitable for cooking just one dish at a time. Perfect for all types of roasts, bread and cakes, and in any case, particularly suitable for fatty meats such as goose and duck.



Fan + lower element

The combination of the fan with just the lower heating element allows cooking to be completed more rapidly. This system is recommended for sterilising or for finishing off the cooking of foods which are already well-cooked on the surface, but not inside, which therefore need a little more heat. Perfect for any type of food.



Small grill

Using only the heat released from the central element, this function allows you to grill small portions of meat and fish for making kebabs, toasted sandwiches and any types of grilled vegetable side dishes.



Grill

The heat coming from the grill element gives perfect grilling results above all for thin and medium thickness meat and allows you to give the food an even browning at the end of the cooking. Perfect for sausages, spare ribs and bacon. This function enables large quantities of food, particularly meat, to be grilled evenly.



Fan with grill

The air produced by the fan softens the strong heatwave generated by the grill, grilling perfectly even very thick foods. Perfect for large cuts of meat (e.g. shin of pork).



Turbo

The combination of fan assisted cooking and traditional cooking allows different foods to be cooked on several levels extremely quickly and efficiently, without odours and flavours mingling. Perfect for large volumes that call for intense cooking.



Fan with round heating element

The combination of the fan and the round heating element (incorporated in the rear of the oven) allows you to cook different foods on several levels, as long as they need the same temperatures and same type of cooking. Hot air circulation ensures instant and even distribution of heat. It will be possible, for instance, to cook fish, vegetables and biscuits simultaneously (on different levels) without odours and flavours mingling.



Use

ECO

This function is particularly suitable for cooking on a single shelf with low energy consumption.

Ideal for cooking meat, fish and vegetables. It is not recommended for leavened foods.

To obtain maximum energy savings and reduce cooking times, it is recommended to place food in the oven without preheating.



When using the ECO function, avoid opening the door during cooking.



Cooking (and preheating) times are longer with the ECO function.



Vapor Clean

This function makes cleaning easier using the steam produced by a small quantity of water poured onto the appropriate groove placed on the bottom.



Switching on the auxiliary oven

To switch on the auxiliary oven:

- Select the temperature using the variable grill knob. The temperature ranges approximately from a minimum of **50 °C** to a maximum of **245 °C**.

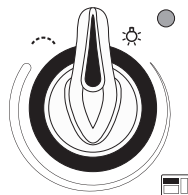

Auxiliary oven functions



Light bulb

Turns on the light inside the oven cavity.



Grill

The heat coming from the grill element gives perfect grilling results above all for thin and medium thickness meat and allows you to give the food an even browning at the end of the cooking. Perfect for sausages, spare ribs and bacon. This function enables large quantities of food, particularly meat, to be grilled evenly.



Switching on the vertical oven

To switch on the vertical oven:

- Turn the knob clockwise to select the required temperature between 50 °C and 245 °C.

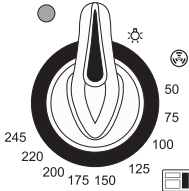

Vertical oven functions



Light bulb

Turns on the light inside the oven cavity.



Fan with round heating element

The combination of the fans and the round heating elements (incorporated in the rear of the oven) allows you to cook different foods on several levels, as long as they need the same temperatures and same type of cooking. Hot air circulation ensures instant and even distribution of heat. It will be possible, for instance, to cook different quantities of the same food simultaneously (on different levels).

3.5 Cooking advice

General advice

- Use a fan assisted function to achieve consistent cooking at several levels.
- It is not possible to shorten cooking times by increasing the temperature (the food could be overcooked on the outside and undercooked on the inside).

Advice for cooking meat

- Cooking times vary according to the thickness and quality of the food and to consumer taste.
- Use a meat thermometer when roasting meat, or simply press on the roast with a spoon. If it is hard, it is ready; If not, it needs another few minutes cooking.

Advice for cooking with the Grill and the Fan with grill

- Meat can be grilled even when it is put into the cold oven or into the preheated oven if you wish to change the effect of the cooking.
- With the Fan with grill function, we recommend that you preheat the oven before grilling.
- We recommend placing the food at the centre of the rack.



Use

- With the Grill function, we recommend that you turn the temperature knob to the maximum value near the symbol  to optimise cooking.
- Foods should be seasoned before cooking. Foods should also be coated with oil or melted butter before cooking.
- Use the oven tray on the first bottom shelf to collect liquids produced by grilling.

Advice for cooking desserts/pastries and biscuits

- Use dark metal moulds: They help to absorb the heat better.
- The temperature and the cooking time depend on the quality and consistency of the dough.
- To check whether the dessert is cooked right through: At the end of the cooking time, put a toothpick into the highest point of the dessert. If the dough does not stick to the toothpick, the dessert is cooked.
- If the dessert collapses when it comes out of the oven, on the next occasion reduce the set temperature by about 10 °C, selecting a longer cooking time if necessary.
- While cooking desserts or vegetables, excessive condensation may form on the glass. In order to avoid this, open the door very carefully a couple of times while cooking.

Advice for defrosting and proving

- Place frozen foods without their packaging in a lidless container on the first shelf of the oven.
- Avoid overlapping the food.
- To defrost meat, use the rack placed on the second level and a tray on the first level. In this way, the liquid from the defrosting food drains away from the food.
- The most delicate parts can be covered with aluminium foil.
- For successful proving, a container of water should be placed in the bottom of the oven.

To save energy

- Stop cooking a few minutes before the time normally used. Cooking will continue for the remaining minutes with the heat which has accumulated inside the oven.
- Reduce any opening of the door to a minimum to avoid heat dispersal.
- Keep the inside of the appliance clean at all times.



3.6 Programmer clock

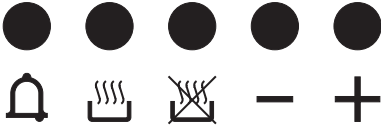



i The programmer clock controls solely the multifunction oven at the bottom left and has no control over the other ovens.

 Minute minder timer key



 Cooking duration key

 End of cooking key

 Decrease key

 Increase key







i Ensure that the programmer clock shows the cooking duration symbol , otherwise it will not be possible to turn on the oven.

Press the keys  and  at the same time to reset the programmer clock.

Setting the time

i If the time is not set, the oven will not switch on.

On the first use, or after a power failure, the digits  will be flashing on the appliance's display.

1. Press the keys  and  at the same time. The dot between the hours and the minutes flashes.
2. The time can be set using  or . Keep the key pressed in to increase or decrease rapidly.
3. Press the key  or wait 5 seconds. The dot between the hours and the minutes stops flashing.
4. The symbol  on the display indicates that the appliance is ready to start cooking.



Timed cooking

i Timed cooking is the function which allows a cooking operation to be started and then ended after a specific length of time set by the user.

1. After selecting a cooking function and temperature, press the key. The display will show the digits and the symbol displayed between the hours and the minutes.
2. Use the or key to set the required minutes.
3. Wait approx. 5 seconds without pressing any key in order for the function to activate. The current time and the symbols and will appear on the display.
4. At the end of cooking the heating elements will be deactivated. On the display, the symbol turns off, the symbol flashes and the buzzer sounds.
5. To turn off the buzzer just press any key of the programmer clock.

6. Press the keys and at the same time to reset the programmer clock.



It is not possible to set a cooking time of more than 10 hours.



After the setting, to display the cooking time left press the key.



To reset the set program, press the keys and at the same time and switch off the oven manually.

Programmed cooking

i Programmed cooking is the function which allows a cooking operation to be started at a set time and then ended after a specific length of time set by the user.

1. Set the cooking time as described in the previous point "Timed cooking".
2. Press the key. The sum of the current time plus the pre-set cooking duration will appear on the display.



3. Use the or key to set the required minutes.
4. Wait approx. 5 seconds without pressing any key in order for the function to activate. The current time and the symbols and will appear on the display.
5. At the end of cooking the heating elements will be deactivated. On the display, the symbol turns off, the symbol flashes and the buzzer sounds.
6. To turn off the buzzer just press any key of the programmer clock.
7. Press the keys and at the same time to reset the programmer clock.



After the setting, to display the cooking time left press the key. To display the end of cooking time, press the key.

Deleting the set data

Press keys and at the same time to reset the programs set. Then switch off the oven manually if cooking is in progress.

Minute minder timer



The minute minder timer does not stop the cooking operation but rather informs the user when the set time has run out.

The minute minder timer can be activated at any time.

1. Press the key. The display shows the digits and the indicator light flashing between the hours and the minutes.
2. Use the or key to set the required minutes.
3. Wait approx. 5 seconds without pressing any key to finish setting the minute minder. The current time and the symbols and appear on the display.



It is not possible to set a cooking time of more than 24 hours.



After the minute minder timer has been programmed, the display will go back to showing the current time. Press the key to display the remaining time.

Adjusting the buzzer volume

The buzzer volume can be set to 3 different levels. When the buzzer is in operation, press the key to change the setting.



Use

Multifunction oven cooking information table

Food	Weight (kg)	Function	Level	Temperature (°C)	Time (minutes)	
Lasagne	3 - 4	Static	1	220 - 230	45 - 50	
Pasta bake	3 - 4	Static	1	220 - 230	45 - 50	
Roasted veal	2	Turbo/Round	2	180 - 190	90 - 100	
Pork loin	2	Turbo/Round	2	180 - 190	70 - 80	
Sausages	1.5	Fan with grill	4	260	15	
Roast beef	1	Turbo/Round	2	200	40 - 45	
Roast rabbit	1.5	Round	2	180 - 190	70 - 80	
Turkey breast	3	Turbo/Round	2	180 - 190	110 - 120	
Roast pork neck	2 - 3	Turbo/Round	2	180 - 190	170 - 180	
Roast chicken	1.2	Turbo/Round	2	180 - 190	65 - 70	
					1nd surface	2nd surface
Pork chops	1.5	Fan with grill	4	260	15	5
Spare ribs	1.5	Fan with grill	4	260	10	10
Bacon	0.7	Grill	5	260	7	8
Pork fillet	1.5	Fan with grill	4	260	10	5
Beef fillet	1	Grill	5	260	10	7
Salmon trout	1.2	Turbo/Round	2	150 - 160	35 - 40	
Delicate fish	1.5	Turbo/Round	2	160	60 - 65	
Flounder	1.5	Turbo/Round	2	160	45 - 50	
Pizza	1	Turbo/Round	2	260	8 - 9	
Bread	1	Round	2	190 - 200	25 - 30	
Focaccia	1	Turbo/Round	2	180 - 190	20 - 25	
Ring cake	1	Round	2	160	55 - 60	
Jam tart	1	Round	2	160	35 - 40	
Ricotta cake	1	Round	2	160 - 170	55 - 60	
Jam tarts	1	Turbo/Round	2	160	20 - 25	
Chiffon cake	1.2	Round	2	160	55 - 60	
Profiteroles	1.2	Turbo/Round	2	180	80 - 90	
Sponge cake	1	Round	2	150 - 160	55 - 60	
Rice pudding	1	Turbo/Round	2	160	55 - 60	
Brioches	0.6	Round	2	160	30 - 35	

The times indicated in the table do not include preheating times and are provided only as a guide.



Auxiliary oven cooking information table

Food	Weight (kg)	Function	Level	Temperature (°C)	Time (minutes)	
Sausages	1.5	Grill	2	MAX	13 - 15	
					1 nd surface	2 nd surface
Pork chops	1.5	Grill	2	MAX	15	5
Spare ribs	1.5	Grill	2	MAX	10	10
Bacon	0.7	Grill	2	MAX	7	8
Pork fillet	1.5	Grill	2	MAX	10	5
Beef fillet	1	Grill	2	MAX	10	7

The times indicated in the table do not include preheating times and are provided only as a guide.

Vertical oven cooking information table

Food	Weight (kg)	Function	Level	Temperature (°C)	Time (minutes)
Roast chicken	1.1 x 4	Round	2-4-6-8	190	80
Frozen pizza	0.3 x 4	Round	2-4-6-8	230	10
Focaccia	0.6 x 4	Round	2-4-6-8	180 - 190	30 - 45
Slices of toast	0.2 x 4	Round	2-4-6-8	180	3 - 5
Brioche	0.4 x 4	Round	2-4-6-8	160	35
Biscuits	0.4 x 4	Round	2-4-6-8	160	23
Chiffon cake	1 x 4	Round	2-4-6-8	160	60

The times indicated in the table do not include preheating times and are provided only as a guide.



Cleaning and maintenance

4 Cleaning and maintenance

Instructions



Improper use

Risk of damage to surfaces

- Do not use steam jets to clean the appliance.
- Do not use cleaning products containing chlorine, ammonia or bleach on parts made of steel or that have metallic surface finishes (e.g. anodizing, nickel- or chromium-plating).
- Do not use abrasive or corrosive detergents (e.g. scouring powders, stain removers and metallic sponges) on glass parts.
- Do not use rough or abrasive materials or sharp metal scrapers.
- Do not wash the removable components such as the hob grids, flame-spreader crowns and burner caps in a dishwasher.
- Do not spill sugar or sweet mixtures on the hob while cooking or place materials or substances which could melt on it (plastic or tin foil).



We recommend the use of cleaning products distributed by the manufacturer.

Cleaning the surfaces

To keep the surfaces in good condition, they should be cleaned regularly after use. Let them cool first.

Ordinary daily cleaning

Always use specific products only that do not contain abrasives or chlorine-based acids.

Pour the product onto a damp cloth and wipe the surface, rinse thoroughly and dry with a soft cloth or a microfibre cloth.

Food stains or residues

Do not use steel sponges and sharp scrapers as they will damage the surface.

Use normal, non-abrasive products and a wooden or plastic tool, if necessary. Rinse thoroughly and dry with a soft cloth or a microfibre cloth.

Do not allow residues of sugary foods (such as jam) to set inside the oven. If left to set for too long, they might damage the enamel lining of the oven.



After cleaning, dry the appliance thoroughly to prevent water or detergent drips from interfering with its operation or creating unsightly marks.



4.1 Cleaning the hob

Cleaning the glass ceramic hob

Light coloured marks from pans with aluminium bases can be easily cleaned off with a cloth moistened in vinegar. After cooking, remove any burnt residues; rinse with water and dry thoroughly with a clean cloth.

Dirt which may have fallen on the hob while cleaning lettuce or potatoes can scratch the hob when moving pans.

Consequently, remove any dirt from the cooking surface immediately.

Changes in colour do not affect the operation and stability of the glass. These are not alterations to the material of the hob but just residues which have not been removed and have then carbonised.

Shiny surfaces can form due to the bases of pans, especially aluminium ones, rubbing on the surface, and due to the use of unsuitable detergents. They are difficult to remove using conventional cleaning products. It may be necessary to repeat the cleaning process several times. Use of corrosive detergents or rubbing of pan bases can wear away the decoration on the hob over time and contribute to the formation of stains.

Weekly cleaning

Clean and maintain the hob once a week using an ordinary glass ceramic cleaning product. Always follow the manufacturer's instructions. The silicon in these products creates a protective, water-repellent membrane which also resists dirt. All marks stay on the membrane and can therefore be removed easily. After cleaning, dry the surface with a clean cloth. Make sure that there is no detergent left on the cooking surface as it might undergo an aggressive reaction when heated up and could modify the structure of the cooking surface.

Knobs



Do not use aggressive products containing alcohol or products for cleaning steel and glass when cleaning the knobs, as these products could cause permanent damage.

The knobs should be cleaned with a soft cloth dampened with warm water, then dried carefully. They can be removed by pulling them out of their housing.



Cleaning and maintenance

4.2 Cleaning the doors

The glass in the door should always be kept thoroughly clean. Use absorbent kitchen roll. In case of stubborn dirt, wash with a damp sponge and an ordinary detergent.

Removing the door (auxiliary oven only)

For easier cleaning it is recommended to remove the door and place it on a tea towel.

To remove the door proceed as follows:

1. Open the door completely and insert two pins into the holes on the hinges indicated in the figure.

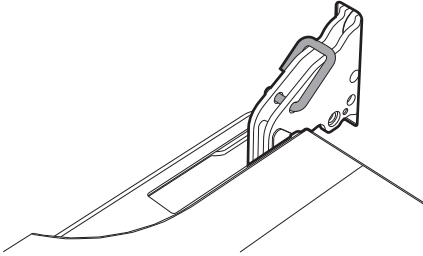

2. Grasp the door on both sides with both hands, lift it forming an angle of around 30° and remove it.

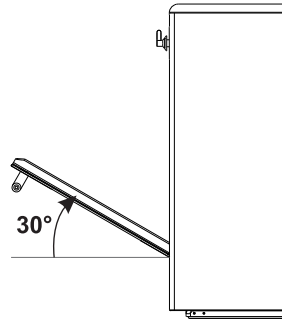

3. To reassemble the door, put the hinges in the relevant slots in the oven, making sure that grooved sections **A** are resting completely in the slots. Lower the door and once it is in place remove the pins from the holes in the hinges.

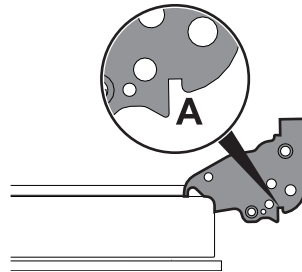



Removing the internal glass panes

For easier cleaning the internal glass panes of the door can be removed.

Main oven door/ lateral

1. Remove the internal glass pane by pulling the top part gently, following the movement indicated by the arrows (1).
2. Then, pull the bottom part upwards (2). This way, the 4 pins attached to the glass detach from their housings in the oven door.

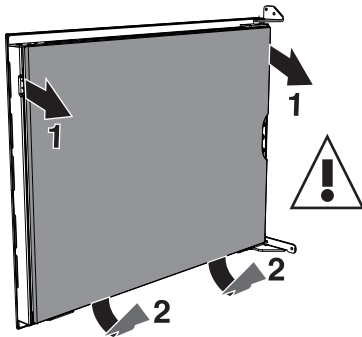

Use kitchen paper to clean. In case of stubborn dirt, wash with a damp sponge and an ordinary detergent.

4. Reposition the internal glass pane. Take care to centre and insert the 4 pins into their housings in the oven door by applying slight pressure.

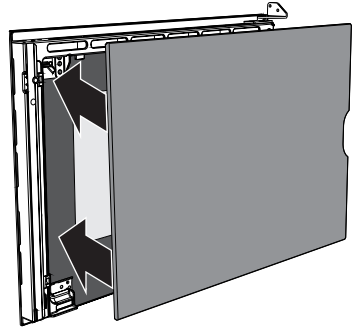

3. After removing the inner glass it is possible to access the drip catcher strip.

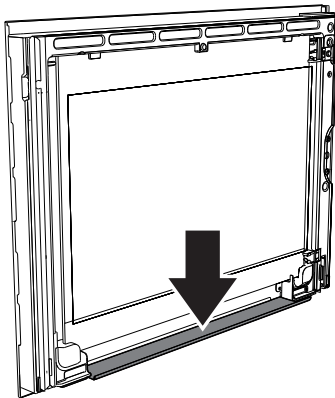



Cleaning and maintenance

Auxiliary oven door

1. Remove the internal glass pane by pulling the rear part gently upwards, following the movement indicated by the arrows (1).
2. Then, pull the front part upwards (2). This way, the 4 pins attached to the glass detach from their housings in the door.

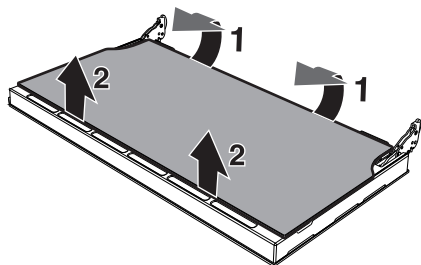

3. Remove the intermediate glass pane by lifting it upwards.

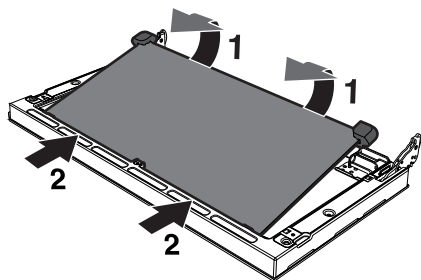

4. Clean the external glass pane and the panes removed previously. Use absorbent kitchen roll. In case of stubborn dirt, wash with a damp sponge and neutral detergent.

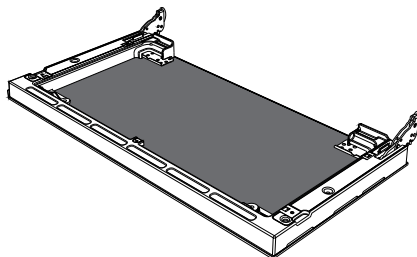

5. Refit the panes in the reverse order in which they were removed.
6. Reposition the internal glass pane. Take care to centre and insert the 4 pins into their housings in the oven door by applying slight pressure.

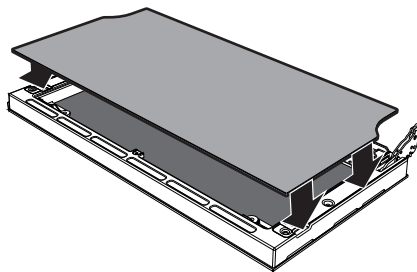



4.3 Cleaning the oven cavities

In order to keep your oven in the best possible condition, clean it regularly after letting it cool down.

Avoid letting food residue dry inside the oven cavity, as this could damage the enamel.

Take out all removable parts before cleaning.

For easier cleaning, it is recommended to remove:

- The door (auxiliary oven only);
- The rack/tray support frames;
- Removable guides, where fitted
- The seal



In the event you are using specific cleaning products, we recommend running the oven at maximum temperature for 15-20 minutes in order to eliminate any residue.

Removing racks/trays support frames

Removing the guide frames enables the sides to be cleaned more easily. This operation should be performed each time the automatic cleaning cycle is used (on some models only).

To remove the guide frames: Pull the frame towards the inside of the oven to unhook it from its groove **A**, then slide it out of the seats **B** at the back.

When cleaning is complete, repeat the above procedures to put the guide frames back in.

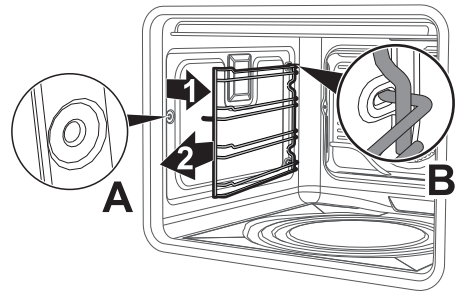

Removing the vertical oven racks/trays support frames

Pull the frame upwards to remove it from its side housings. Replace the frame correctly when you have finished cleaning.

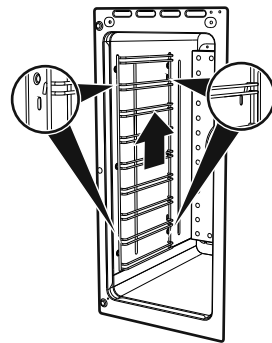



Cleaning and maintenance

Cleaning the upper part (multifunction and auxiliary ovens only)



High temperature inside the oven during use

Danger of burns

- The following operations must be carried out only with the oven completely cold and turned off.

The appliance is fitted with a tilting heating element that makes it easier to clean the top part of the oven.

1. Free the upper heating element by gently lifting it and rotating its retaining latch by 90 degrees.

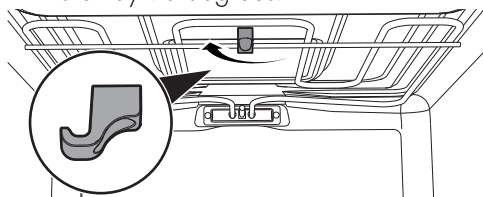

2. Gently lower the heating element until it stops.

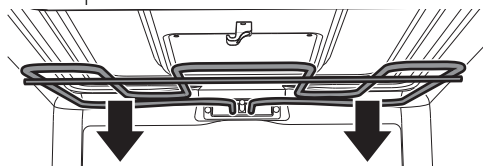

Improper use

Risk of damage to the appliance

- Do not excessively flex the element during cleaning.

3. When you have finished cleaning, place the heating element back in position and turn the retaining latch to lock it in place.

4.4 Vapor Clean (multifunction oven only)



Vapor Clean is an assisted cleaning procedure which facilitates the removal of dirt. This process makes it possible to clean the inside of the oven very easily. The dirt residues are softened by the heat and water vapour for easier removal afterwards.



Improper use

Risk of damage to surfaces

- Remove any large amounts of food residues or spills from previous cooking operations from the inside of the oven.
- Carry out assisted oven cleaning operations only when the oven is cold.

Preliminary operations

Before starting the Vapor Clean cleaning cycle:

- Completely remove all accessories from inside the oven.



- Pour approx. 40 cc of water onto the floor of the oven. Make sure it does not overflow out of the cavity.

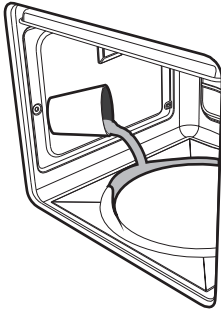

- Spray a water and washing up liquid solution inside the oven using a spray nozzle. Direct the spray against the side walls, upwards, downwards and towards the deflector.

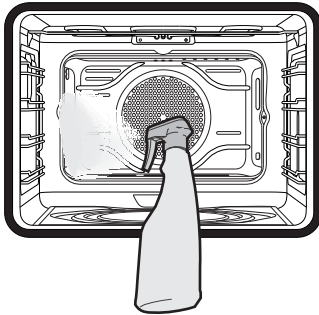



- Close the door.



We recommend spraying approx. 20 times at the most.

Vapor Clean setting

1. Turn the function knob to the symbol  and the temperature knob to the symbol .
2. Set a cooking time of 18 minutes using the programmer clock.
3. At the end of the cooking time, the timer will switch the oven cavity heating elements off and the buzzer will start to sound.

End of the Vapor Clean cycle

4. Open the door and wipe away the less stubborn dirt with a microfibre cloth.
5. Use an anti-scratch sponge with brass filaments on tougher encrustations.
6. In case of grease residues use specific oven cleaning products.
7. Remove the residual water inside the oven.

For improved hygiene and to avoid food being affected by any unpleasant odours, we recommend that the oven is dried using a fan assisted function at 160 °C for approximately 10 minutes.



We recommend wearing rubber gloves for these operations.



For easier manual cleaning of parts that are difficult to reach, we recommend removing the door.



Cleaning and maintenance

4.5 Extraordinary maintenance

Replacing the internal light bulb



Live parts

Danger of electrocution

- Unplug the appliance from the mains.



The oven is fitted with a 40W light bulb.

1. Completely remove all accessories from inside the oven.
2. Remove the rack/tray support frames.
3. Remove the bulb cover using a tool (e.g. a screwdriver).



Take care not to scratch the enamel of the oven cavity wall.

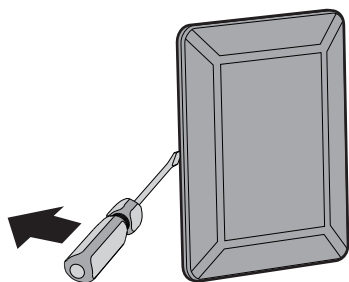

4. Slide out and remove the light bulb.

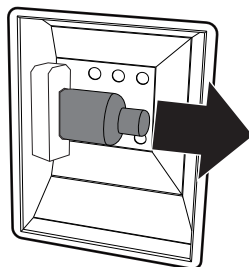

Do not touch the halogen light bulb directly with your fingers, use an insulating material.

5. Fit the new light bulb.
6. Refit the cover. Ensure the moulded part of the glass (A) is facing the door.

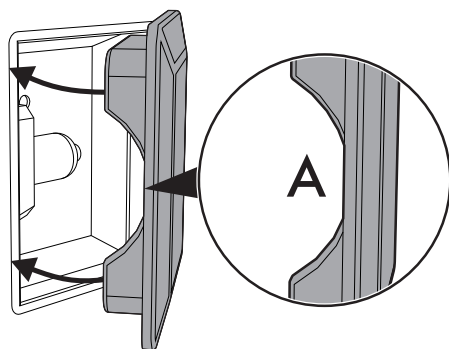

7. Press the cover completely down so that it attaches perfectly to the bulb support.



Installing and removing the seal

To remove the seal:

- Unhook the clips in the 4 corners then pull the seal outwards.

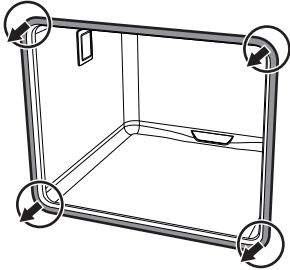

To refit the seal:

- Hook the clips in the 4 corners onto the seal.

Seal maintenance tips

The seal should be soft and elastic.

- To keep the seal clean, use a non-abrasive sponge and wash with lukewarm water.

What to do if...

The appliance does not work:

- The switch is defective: check the fuse box to see whether the switch is in working order.
- Loss of power: check that the appliance indicator lights are operational.

The gas burner does not light:

- Loss of power or moisture in the igniters: light the gas burner with a lighter or match.

The oven does not heat up:

- Defective fuse: check and replace the switch if necessary.
- The function knob has not been set: set the function knob.

All food prepared in the oven cavity burns within a short time:

- Defective thermostat: contact an Authorised Service Centre

The door glass mists up when the oven is hot:

- Completely normal behaviour caused by the difference in temperature which has no effect on the oven's performance.

The display is completely off:

- Check the mains power supply.
- Check that any circuit breaker/switch upline of the appliance power supply connection is in the "ON" position.



If the problem has not been resolved or in the case of other types of fault, contact your local technical support centre.



Installation

5 Installation

5.1 Positioning



**Heavy appliance
Crushing hazard**

- Position the appliance into the cabinet cut-out with the help of a second person.



**Pressure on the open door
Risk of damage to the appliance**

- Never use the oven door to lever the appliance into place when fitting.
- Avoid exerting too much pressure on the door when open.



**Heat production during appliance operation
Risk of fire**

- Veneers, adhesives or plastic coatings on adjacent furniture should be temperature-resistant (not less than 90 °C).

This appliance may be installed next to walls, one of which must be higher than the worktop, at a minimum distance of **X** mm from the side of the appliance, as shown in figures "A" and "C" relative to the installation classes.

Any wall units positioned above the worktop of the appliance must be at a minimum distance of at least **Y** mm. If a hood is installed above the hob, refer to the hood instruction manual to ensure the correct clearance is left.

X	150 mm
Y	750 mm

Depending on the type of installation, this appliance belongs to classes:

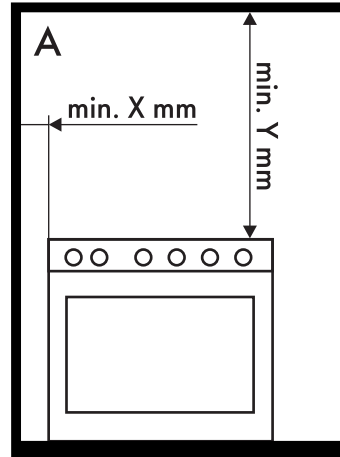

A - Class 1

(Free-standing appliance)

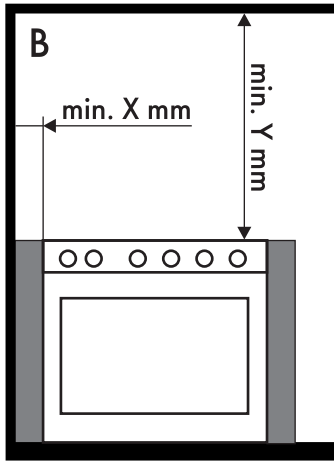

B - Class 2 subclass 1
(Built-in appliance)

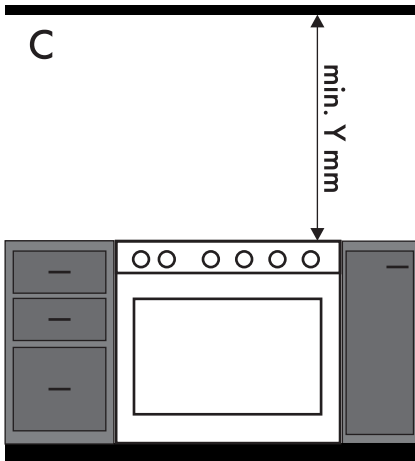

C - Class 2 subclass 1
(Built-in appliance)



The appliance must be installed by a qualified technician and according to the regulations in force.

Appliance overall dimensions

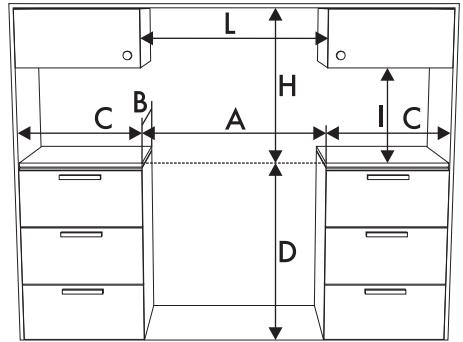

A	900 mm
B	600 mm
C¹	min. 150 mm
D	900 - 915 mm
H	750 mm
I	450 mm
L²	900 mm

¹ Minimum distance from side walls or other flammable material.

² Minimum cabinet width (=A).



Installation

Appliance dimensions

Position of gas and electrical connections.

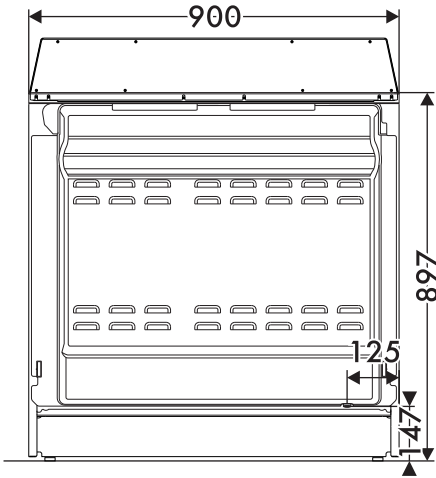

Positioning and levelling



Heavy appliance
Risk of damage to the appliance

- Insert the front feet first and then the rear ones.

The appliance must sit level on the floor to ensure stability.

- After making the gas and electrical connections, level and stabilise the appliance on the floor by screwing the foot in or out.

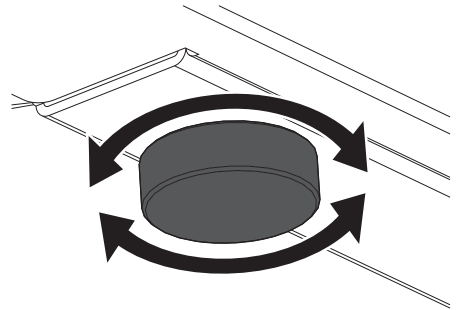



Assembling the upstand

i The upstand provided is an integral part of the product; it must be fastened to the appliance prior to installation.

The upstand must always be positioned and secured correctly on the appliance.

1. Loosen the 6 screws on the back of the hob (A) and unscrew the 2 screws (B) on the side part of the upstand.

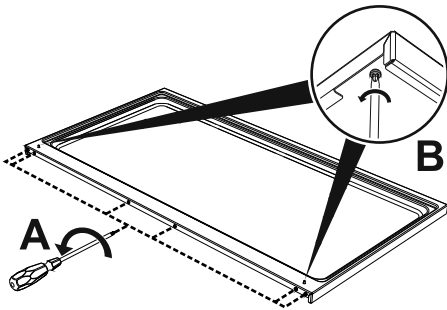

2. Place the upstand on the hob. Align the 6 bottom slots of the upstand with the 6 screws on the back of the hob that were previously loosened.
3. Tighten the 6 screws on the back of the hob (A) and the 2 screws under the hob (B) to secure the upstand.

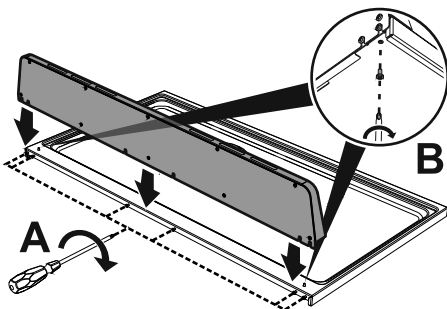

Mounting the toe skirt

i The toe skirt provided is an integral part of the product; it must be fastened to the appliance prior to installation.

The toe skirt must always be positioned and secured correctly on the appliance.

1. Place the toe skirt in the front bottom part of the appliance.
2. Screw the two side screws to fasten the toe skirt to the appliance.
3. Cover the holes of the toe skirt with the plugs provided.

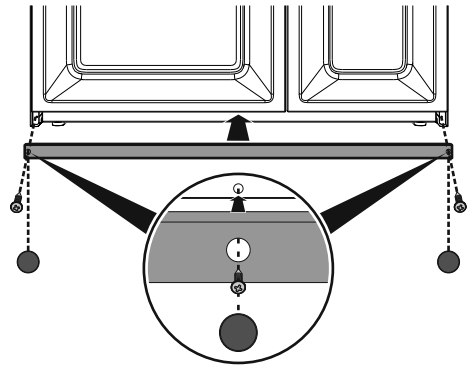



Installation

5.2 Electrical connection



**Power voltage
Danger of electrocution**

- Have the electrical connection performed by authorised technicians.
- Use personal protective equipment.
- The appliance must be connected to ground in compliance with electrical system safety standards.
- Disconnect the mains power supply.
- Do not pull the cable to remove the plug.
- Use H05V2V2-F cables withstanding a temperature of at least 90 °C.
- The tightening torque of the screws of the terminal board leads must be 1.5 - 2 Nm.

General information

Check the mains characteristics against the data indicated on the plate.

The identification plate bearing the technical data, serial number and brand name is visibly positioned on the appliance.

Do not remove this plate for any reason.

Perform the ground connection using a wire that is 20 mm longer than the other wires.

The appliance can work in the following modes:

- **220-240 V 2~**

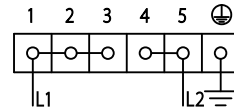

3 x 10 mm² three-core cable.

- **3220-240 V 3~**

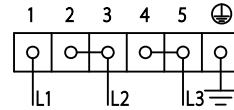

4 x 6 mm² four-core cable.

- **220-240 V 1N~**

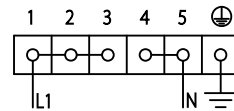

3 x 10 mm² three-core cable.



- 380-415 V 2N~

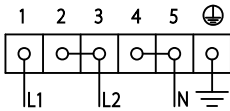

4 x 6 mm² four-core cable.

- 380-415 V 3N~

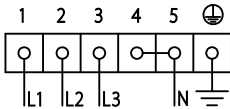

5 x 4 mm² five-core cable.



The values indicated above refer to the cross-section of the internal lead.



The aforementioned power cables are sized taking into account the coincidence factor (in compliance with standard EN 60335-2-6).

Replacement U-bolt

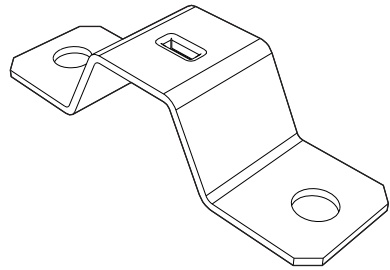

In the event of connection to a two- or three-phase supply, the installed U-bolt must be replaced with the one supplied in order to ensure correct fastening of the cable.

Fixed connection

Fit the power line with an omnipolar circuit breaker in compliance with installation regulations.

The circuit breaker should be located near the appliance and in an easily reachable position.

Connection with plug and socket

Make sure that the plug and socket are of the same type.

Avoid using adapters, gang sockets or extensions as these could cause overheating and a risk of burns.



5.3 Instructions for the installer

- The plug must be accessible after installation. Do not bend or trap the power cable.
- The appliance must be installed according to the installation diagrams.
- If the appliance does not work correctly after having carried out all the checks, contact your local Authorised Service Centre.
- Once the appliance has been installed, please explain to the user how to use it correctly.